

z/OS



# XL C/C++ Programming Guide

*Version 2 Release 2*

**Note**

Before using this information and the product it supports, read the information in "Notices" on page 1169.

This edition applies to Version 2 Release 2 of z/OS (5650-ZOS) and to all subsequent releases and modifications until otherwise indicated in new editions.

© **Copyright IBM Corporation 1996, 2017.**

US Government Users Restricted Rights – Use, duplication or disclosure restricted by GSA ADP Schedule Contract with IBM Corp.

# Contents

**Figures . . . . . xv**

**Tables . . . . . xix**

**About this document . . . . . xxv**

Related z/OS XL C/C++ information . . . . . xxxiii

Where to find more information . . . . . xxxiii

Information updates on the web . . . . . xxxiii

The z/OS Basic Skills Information Center . . . . . xxxiii

How to send your comments to IBM . . . . . xxxiv

If you have a technical problem . . . . . xxxiv

**What's new for z/OS V2R2 XL C/C++ . . . . . xxxv**

**Part 1. Introduction . . . . . 1**

**Chapter 1. About IBM z/OS XL C/C++ . . . . . 3**

**Part 2. Input and Output. . . . . 5**

**Chapter 2. Introduction to C and C++  
input and output . . . . . 7**

Types of C and C++ input and output . . . . . 7

Text streams . . . . . 7

Binary streams. . . . . 8

Record I/O . . . . . 8

Blocked I/O . . . . . 8

**Chapter 3. Understanding models of C  
I/O. . . . . 11**

The record model for C I/O . . . . . 11

Record formats . . . . . 11

The byte stream model for C I/O . . . . . 20

Mapping the C types of I/O to the byte stream  
model . . . . . 21

**Chapter 4. Using the Standard C++  
Library I/O Stream Classes . . . . . 23**

Advantages to using the C++ I/O stream classes . . . . . 23

Predefined streams for C++ . . . . . 23

How C++ I/O streams relate to C I/O streams . . . . . 24

Mixing the Standard C++ I/O stream classes, USL

I/O stream class library, and C I/O library functions . . . . . 24

Specifying file attributes . . . . . 24

**Chapter 5. Opening files . . . . . 27**

Prototypes of functions . . . . . 27

Categories of I/O . . . . . 29

Specifying what kind of file to use. . . . . 30

OS files. . . . . 30

UNIX file system files . . . . . 30

VSAM data sets . . . . . 30

Terminal files. . . . . 30

Memory files and hiperspace memory files . . . . . 31

CICS data queues . . . . . 32

z/OS Language Environment Message file . . . . . 32

How to specify RECFM, LRECL, and BLKSIZE . . . . . 32

fopen() defaults . . . . . 34

DDnames . . . . . 36

Avoiding Undesirable Results when Using I/O . . . . . 37

How z/OS XL C/C++ determines what kind of file  
to open. . . . . 37

Under TSO, MVS batch, IMS — POSIX(ON) . . . . . 38

Under TSO, MVS batch, IMS — POSIX(OFF) . . . . . 41

Under CICS . . . . . 43

**Chapter 6. Buffering of C streams . . . . . 45**

**Chapter 7. Using ASA text files . . . . . 47**

Example of writing to an ASA file . . . . . 47

ASA file control . . . . . 48

**Chapter 8. z/OS XL C Support for the  
double-byte character set . . . . . 53**

Opening files . . . . . 54

Reading streams and files . . . . . 54

Writing streams and files . . . . . 56

Writing text streams . . . . . 56

Writing binary streams . . . . . 58

Flushing buffers . . . . . 58

Flushing text streams . . . . . 58

Flushing binary streams . . . . . 59

ungetc() considerations . . . . . 59

Setting positions within files. . . . . 59

Repositioning within text streams . . . . . 59

Repositioning within binary streams . . . . . 60

ungetc() considerations . . . . . 60

Closing files . . . . . 61

Manipulating wide character array functions . . . . . 61

**Chapter 9. Using C and C++ standard  
streams and redirection . . . . . 63**

Default open modes . . . . . 64

Interleaving the standard streams with

sync\_with\_stdio() . . . . . 65

Interleaving the standard streams without

sync\_with\_stdio() . . . . . 66

Redirecting standard streams . . . . . 68

Redirecting streams from the command line . . . . . 68

Using the redirection symbols . . . . . 69

Assigning the standard streams. . . . . 70

Using the freopen() library function . . . . . 70

Redirecting streams with the MSGFILE option. . . . . 70

MSGFILE considerations . . . . . 70

Redirecting streams under z/OS . . . . . 72

Under MVS batch . . . . . 72

Under TSO . . . . .	74
Under IMS . . . . .	74
Under CICS . . . . .	75
Passing C and C++ standard streams across a system() call . . . . .	75
Passing binary streams . . . . .	75
Passing text streams . . . . .	76
Passing record I/O streams . . . . .	78
Passing blocked I/O streams . . . . .	78
Using global standard streams . . . . .	78
Command line redirection . . . . .	80
Direct assignment . . . . .	81
freopen() . . . . .	81
MSGFILE() runtime option . . . . .	81
fclose() . . . . .	82
File position and visible data . . . . .	82
C++ I/O stream library . . . . .	82

## Chapter 10. Performing OS I/O operations . . . . . 83

Opening files . . . . .	83
Using fopen() or freopen() . . . . .	83
Generation data group I/O . . . . .	87
Regular and extended partitioned data sets . . . . .	89
Partitioned and sequential concatenated data sets . . . . .	91
In-stream data sets . . . . .	93
SYSOUT data sets . . . . .	93
Tapes . . . . .	94
Multivolume data sets . . . . .	95
Striped data sets . . . . .	95
Large format sequential data sets . . . . .	96
Other devices . . . . .	96
Access method selection . . . . .	97
fopen() and freopen() parameters . . . . .	97
Buffering . . . . .	101
Multiple buffering . . . . .	102
DCB (Data Control Block) attributes . . . . .	103
Reading from files . . . . .	105
Reading from binary files . . . . .	106
Reading from text files . . . . .	106
Reading from record I/O files . . . . .	106
Reading from blocked I/O files . . . . .	107
Writing to files . . . . .	107
Writing to binary files . . . . .	108
Writing to text files . . . . .	109
Writing to record I/O files . . . . .	112
Writing to blocked I/O files . . . . .	112
Flushing buffers . . . . .	112
Updating existing records . . . . .	113
Reading updated records . . . . .	113
Writing new records . . . . .	113
ungetc() considerations . . . . .	114
Repositioning within files . . . . .	115
ungetc() considerations . . . . .	116
How long fgetpos() and ftell() values last . . . . .	117
Using fseek() and ftell() in binary files . . . . .	117
Using fseek() and ftell() in text files (ASA and Non-ASA) . . . . .	118
Using fseek() and ftell() in record files . . . . .	119
Using fseek() and ftell() in blocked files . . . . .	119
Porting old C code that uses fseek() or ftell() . . . . .	120

Closing files . . . . .	120
Renaming and removing files . . . . .	123
fldata() behavior . . . . .	123

## Chapter 11. Performing z/OS UNIX file system I/O operations. . . . . 127

Creating files . . . . .	127
Regular files . . . . .	127
Link and symbolic link files . . . . .	128
Directory files . . . . .	128
Character special files . . . . .	128
FIFO files . . . . .	128
Opening files . . . . .	128
Using fopen() or freopen() . . . . .	129
Reading from z/OS UNIX file system files . . . . .	133
Opening and reading from z/OS UNIX file system directory files . . . . .	133
Writing to z/OS UNIX file system files . . . . .	134
Flushing records . . . . .	134
Setting positions within files . . . . .	134
Closing files . . . . .	135
Deleting files . . . . .	135
Pipe I/O . . . . .	136
Using unnamed pipes . . . . .	136
Using named pipes . . . . .	137
Character special file I/O . . . . .	140
Low-level z/OS UNIX I/O . . . . .	141
Example of z/OS UNIX file system I/O functions . . . . .	141
fldata() behavior . . . . .	147
File tagging and conversion . . . . .	149
Access control lists (ACLs) . . . . .	149

## Chapter 12. Performing VSAM I/O operations. . . . . 151

VSAM types (data set organization) . . . . .	151
Access method services . . . . .	152
Choosing VSAM data set types . . . . .	152
Keys, RBAs and RRNs . . . . .	154
Summary of VSAM I/O operations . . . . .	155
Opening VSAM data sets . . . . .	156
Using fopen() or freopen() . . . . .	156
Buffering . . . . .	161
Record I/O in VSAM . . . . .	161
RRDS record structure . . . . .	161
Reading record I/O files . . . . .	162
Writing to record I/O files . . . . .	163
Updating record I/O files . . . . .	164
Deleting records . . . . .	165
Repositioning within record I/O files . . . . .	165
Flushing buffers . . . . .	168
Summary of VSAM record I/O operations . . . . .	168
VSAM record level sharing and transactional VSAM . . . . .	169
Error reporting . . . . .	170
VSAM extended addressability . . . . .	171
Text and binary I/O in VSAM . . . . .	172
Reading from text and binary I/O files . . . . .	172
Writing to and updating text and binary I/O files . . . . .	172
Deleting records in text and binary I/O files . . . . .	172

Repositioning within text and binary I/O files	173
Flushing buffers	174
Summary of VSAM text I/O operations	175
Summary of VSAM binary I/O operations	176
Closing VSAM data sets	176
VSAM return codes	177
VSAM examples	177
KSDS example	177
RRDS example	186
fldata() behavior	188

### Chapter 13. Performing terminal I/O operations. . . . . 191

Opening files	191
Using fopen() and freopen()	191
Buffering	193
Reading from files	193
Reading from binary files	195
Reading from text files	195
Reading from record I/O files	195
Writing to files	196
Writing to binary files	196
Writing to text files	197
Writing to record I/O files	197
Flushing records	197
Text streams	198
Binary streams	198
Record I/O	198
Repositioning within files	198
Closing files	198
fldata() behavior	199

### Chapter 14. Performing memory file and hiperspace I/O operations . . . . 201

Using hiperspace operations	201
Opening files	202
Using fopen() or freopen()	202
Simulating partitioned data sets	206
Buffering	208
Reading from files	209
Writing to files	210
Flushing records	210
ungetc() considerations	211
Repositioning within files	211
Closing files	212
Performance tips	212
Removing memory files	212
fldata() behavior	212
Example program	213

### Chapter 15. Performing CICS Transaction Server I/O operations . . 215

### Chapter 16. Language Environment Message file operations . . . . . 217

Opening files	217
Reading from files	217
Writing to files	218
Flushing buffers	218

Repositioning within files	218
Closing files	218

### Chapter 17. CELQPIPI MSGRTN file operations. . . . . 219

Opening files	219
Reading from files	219
Writing to files	219
Flushing buffers	219
Repositioning within files	219
Closing files	220
fldata() behavior	220
fldata() example	221

### Chapter 18. Debugging I/O programs 223

Using the __amrc structure	223
Using the __amrc2 structure	227
Using __last_op codes	227
Using the SIGIOERR signal	231
File I/O trace	234
Locating the file I/O trace	234

## Part 3. Interlanguage Calls with z/OS XL C/C++ . . . . . 237

### Chapter 19. Using Linkage Specifications in C or C++. . . . . 239

Syntax for Linkage in C or C++	239
Syntax for Linkage in C	239
Syntax for Linkage in C++	240
Kinds of Linkage used by C or C++ Interlanguage Programs	240
Using Linkage Specifications in C++	242

### Chapter 20. Combining C or C++ and Assembler programs . . . . . 245

Establishing the z/OS XL C/C++ environment	245
Specifying linkage for C or C++ to Assembler	246
Parameter lists for OS linkage	246
XPLINK Assembler	247
Using standard macros	249
Non-XPLINK assembler prolog	249
Non-XPLINK assembler epilog	250
XPLINK Assembler prolog	250
XPLINK Call	252
XPLINK Assembler epilog	254
Accessing automatic memory in the non-XPLINK stack	254
Calling C code from Assembler — C example	255
Calling runtime library routines from Assembler — C++ example	256
Register content at entry to a non-XPLINK ASM routine using OS linkage	258
Register content at exit from a non-XPLINK ASM routine to z/OS XL C/C++	258
Retaining the C environment using preinitialization	258
Setting up the interface for preinitializable programs	259
Preinitializing a C program	263

Multiple preinitialization compatibility interface	
C environments . . . . .	270
Using the service vector and associated routines	272

## Part 4. Coding: Advanced Topics 279

### Chapter 21. Building and using Dynamic Link Libraries (DLLs) . . . . 281

Support for DLLs . . . . .	282
DLL concepts and terms. . . . .	282
Loading a DLL . . . . .	283
Loading a DLL implicitly . . . . .	283
Loading a DLL explicitly . . . . .	284
Managing the use of DLLs when running DLL applications . . . . .	288
Loading DLLs . . . . .	288
Sharing DLLs . . . . .	290
Freeing DLLs . . . . .	290
Creating a DLL or a DLL application . . . . .	290
Building a simple DLL . . . . .	290
Example of building a simple C DLL . . . . .	291
Example of building a simple C++ DLL . . . . .	291
Compiling your code. . . . .	292
Binding your code. . . . .	293
Building a simple DLL application . . . . .	294
Steps for using an implicitly loaded DLL in your simple DLL application . . . . .	294
Creating and using DLLs . . . . .	296
DLL restrictions . . . . .	297
Improving performance . . . . .	299

### Chapter 22. Building complex DLLs 301

Rules for compiling source code with XPLINK . . . . .	302
XPLINK applications . . . . .	302
Non-XPLINK applications . . . . .	303
Compatibility issues between DLL and non-DLL code . . . . .	305
Pointer assignment . . . . .	306
Function pointers . . . . .	306
DLL function pointer call in non-DLL code . . . . .	308
C example . . . . .	309
Non-DLL function pointer call in DLL(CBA) code . . . . .	311
Non-DLL function pointer call in DLL code . . . . .	313
Function pointer comparison in non-DLL code . . . . .	314
Function pointer comparison in DLL code. . . . .	317
Using DLLs that call each other . . . . .	319

### Chapter 23. z/OS 64-bit environment 325

Differences between the ILP32 and LP64 environments . . . . .	325
ILP32 and LP64 addressing capabilities. . . . .	325
ILP32 and LP64 data models and data type sizes	325
Advantages and disadvantages of the LP64 environment. . . . .	326
LP64 application performance and program size	326
LP64 restrictions . . . . .	327
Migrating applications from ILP32 to LP64 . . . . .	327
When to migrate applications to LP64 . . . . .	327

Checklist for ILP32-to-LP64 pre-migration activities . . . . .	328
Checklist for ILP32-to-LP64 post-migration activities . . . . .	328
Using compiler diagnostics to ensure portability of code . . . . .	329
Using the INFO option to ensure that numbers are suffixed . . . . .	329
Using the WARN64 option to identify potential portability problems . . . . .	330
ILP32-to-LP64 portability issues . . . . .	331
IPA(LINK) option and exploitation of 64-bit virtual memory. . . . .	332
Availability of suboptions . . . . .	332
Potential changes in structure size and alignment . . . . .	332
Data type assignment differences under ILP32 and LP64. . . . .	337
Pointer declarations when 32-bit and 64-bit applications share header files. . . . .	341
Potential pointer corruption . . . . .	342
Potential loss of data in constant expressions	343
Data alignment problems when structures are shared. . . . .	344
Portability issues with unsuffixed numbers . . . . .	346
Using a LONG_MAX macro in a printf subroutine . . . . .	347
Programming for portability between ILP32 and LP64 . . . . .	348
Using header files to provide type definitions	348
Using suffixes and explicit types to prevent unexpected behavior . . . . .	348
Defining pad members to avoid data alignment problems . . . . .	349
Using prototypes to avoid debugging problems	350
Using a conditional compiler directive for preprocessor macro selection . . . . .	351
Using converters under ILP32 or LP64 . . . . .	351
Using locales under ILP32 or LP64 . . . . .	351

### Chapter 24. Using threads in z/OS UNIX applications . . . . . 353

Models and requirements . . . . .	353
Functions. . . . .	353
Creating a thread . . . . .	353
Synchronization primitives . . . . .	355
Thread-specific data . . . . .	358
Signals . . . . .	360
Generating a signal . . . . .	361
Thread cancellation . . . . .	362
Cleanup for threads . . . . .	364
Thread stack attributes . . . . .	364
Behaviors and restrictions in z/OS UNIX applications . . . . .	365
Using threads with MVS files . . . . .	365
Multithreaded I/O . . . . .	366
Thread-scoped functions. . . . .	366
Unsafe thread functions . . . . .	367
Fetched functions and writable statics . . . . .	367
MTF and z/OS UNIX threading . . . . .	367
Thread queuing function . . . . .	367



Thread scheduling . . . . .	367
iconv() family of functions . . . . .	368
Threads and recoverable resources . . . . .	368

## Chapter 25. Reentrancy in z/OS XL

<b>C/C++ . . . . .</b>	<b>369</b>
Natural or constructed reentrancy . . . . .	370
Limitations of constructed reentrancy for C programs . . . . .	370
Controlling external static in C programs . . . . .	370
Controlling writable strings . . . . .	371
Controlling the memory area in C++ . . . . .	372
Controlling where string literals exist in C++ code . . . . .	373
Using writable static in Assembler code . . . . .	373

## Chapter 26. Using decimal data types in C . . . . .

<b>377</b>	
Decimal data type declarations . . . . .	377
Declaring fixed-point decimal constants . . . . .	378
Declaring decimal variables . . . . .	378
Defining decimal-type constants . . . . .	379
Using operators on decimal data types . . . . .	380
Arithmetic operators . . . . .	380
Assignment operators . . . . .	383
Unary operators . . . . .	383
Summary of operators used with decimal types . . . . .	385
Converting decimal types . . . . .	385
Converting decimal types to decimal types . . . . .	385
Converting decimal types to and from integer types . . . . .	387
Converting decimal data types to and from floating-point data types . . . . .	388
Calling functions with decimal data types . . . . .	389
Using library functions . . . . .	389
Using variable arguments with decimal data types . . . . .	390
Formatting input and output operations with decimal data types . . . . .	390
Validating decimal values . . . . .	390
Fixing sign variables . . . . .	391
Returning decimal absolute values . . . . .	391
Programming examples . . . . .	392
Decimal exception handling . . . . .	394
printf() and scanf() and format validation . . . . .	395
Additional considerations . . . . .	395
Error messages . . . . .	395
Decimal exceptions and Assembler interlanguage calls . . . . .	396

## Chapter 27. IEEE Floating-Point . . . . .

<b>397</b>	
Floating-point numbers . . . . .	397
C/C++ compiler support . . . . .	398
Using IEEE floating-point . . . . .	399

## Chapter 28. Handling error conditions, exceptions, and signals . . . . .

<b>403</b>	
Handling C software exceptions under C++ . . . . .	404
Handling hardware exceptions under C++ . . . . .	404
Tracebacks under C++ . . . . .	404

AMODE 64 exception handlers . . . . .	407
Scope and nesting of exception handlers . . . . .	407
Handling exceptions . . . . .	408
Signal handlers . . . . .	408
Handling signals with POSIX(OFF) using signal() and raise() . . . . .	409
Handling signals using Language Environment callable services . . . . .	409
Handling signals using z/OS UNIX with POSIX(ON) . . . . .	410
Asynchronous signal delivery under z/OS UNIX . . . . .	412
C signal handling features under z/OS XL C/C++ . . . . .	413

## Chapter 29. Network communications under UNIX System Services. . . . .

<b>425</b>	
Understanding z/OS UNIX sockets and internetworking . . . . .	425
Basics of network communication . . . . .	426
Transport protocols for sockets . . . . .	426
What is a socket? . . . . .	427
z/OS UNIX Socket families . . . . .	428
z/OS UNIX Socket types . . . . .	428
Guidelines for using socket types . . . . .	429
Addressing within sockets . . . . .	429
The conversation . . . . .	432
The server perspective . . . . .	433
The client perspective . . . . .	435
A typical TCP socket session . . . . .	435
A typical UDP socket session . . . . .	436
Locating the server's port . . . . .	437
Network application example . . . . .	437
Using common INET . . . . .	443
Compiling and binding . . . . .	444
Using TCP/IP APIs . . . . .	445
Restrictions for using z/OS TCP/IP API with z/OS UNIX . . . . .	446
Using z/OS UNIX sockets . . . . .	447
Compiling under MVS batch for Berkeley sockets . . . . .	448
Compiling under MVS batch for X/Open sockets . . . . .	449
Understanding the X/Open Transport Interface (XTI) . . . . .	450
Transport endpoints . . . . .	451
Transport providers for X/Open Transport Interface . . . . .	451
General restrictions for z/OS UNIX . . . . .	451

## Chapter 30. Interprocess communication using z/OS UNIX . . . . .

<b>453</b>	
Message queues . . . . .	453
Semaphores . . . . .	454
Shared memory . . . . .	454
Memory mapping . . . . .	454
TSO commands from a shell . . . . .	455

## Chapter 31. Using templates in C++ programs . . . . . 457

Using the TEMPINC compiler option . . . . .	458
TEMPINC example . . . . .	458
Regenerating the template instantiation file . . . . .	461
TEMPINC considerations for shared libraries . . . . .	461
Using the TEMPLATEDEPTH compiler option . . . . .	461
Using the TEMPLATEREGISTRY compiler option . . . . .	461
Recompiling related compilation units . . . . .	462
Switching from TEMPINC to TEMPLATEREGISTRY . . . . .	462
Using explicit instantiation declarations (C++11 only) . . . . .	462
Examples of explicit instantiation declarations . . . . .	464

## Chapter 32. Using environment variables . . . . . 467

Working with environment variables . . . . .	475
Naming conventions . . . . .	476
Environment variables specific to the z/OS XL C/C++ library . . . . .	477
_CEE_DLLLOAD_XPCOMPAT . . . . .	478
_CEE_DMPTARG . . . . .	479
_CEE_ENVFILE . . . . .	480
_CEE_ENVFILE_COMMENT . . . . .	480
_CEE_ENVFILE_CONTINUATION . . . . .	481
_CEE_ENVFILE_S . . . . .	481
_CEE_HEAP_MANAGER . . . . .	482
_CEE_REALLOC_CONTROL . . . . .	483
_CEE_RUNOPTS . . . . .	484
_EDC_ADD_ERRNO2 . . . . .	486
_EDC_ANSI_OPEN_DEFAULT . . . . .	487
_EDC_AUTOCVT_BINARY . . . . .	487
_EDC_BYTE_SEEK . . . . .	487
_EDC_CLEAR_SCREEN . . . . .	488
_EDC_COMPAT . . . . .	488
_EDC_CONTEXT_GUARD . . . . .	489
_EDC_C99_NAN . . . . .	489
_EDC_DLL_DIAG . . . . .	489
_EDC_EOVERFLOW . . . . .	490
_EDC_ERRNO_DIAG . . . . .	491
_EDC_FLUSH_STDOUT_PIPE . . . . .	491
_EDC_FLUSH_STDOUT_SOCKET . . . . .	492
_EDC_GLOBAL_STREAMS . . . . .	493
_EDC_IEEEV1_COMPATIBILITY_ENV . . . . .	493
_EDC_IO_ABEND . . . . .	494
_EDC_IO_TRACE . . . . .	495
_EDC_OPEN_CONCAT . . . . .	497
_EDC_POPEN . . . . .	497
_EDC_PTHREAD_YIELD . . . . .	497
_EDC_PTHREAD_YIELD_MAX . . . . .	498
_EDC_PUTENV_COPY . . . . .	498
_EDC_RRDS_HIDE_KEY . . . . .	499
_EDC_STOR_INCREMENT . . . . .	499
_EDC_STOR_INCREMENT_B . . . . .	500
_EDC_STOR_INITIAL . . . . .	500
_EDC_STOR_INITIAL_B . . . . .	501
_EDC_STRPTM_STD . . . . .	501
_EDC_SUSV3 . . . . .	501
_EDC_UMASK_DFLT . . . . .	502

_EDC_ZERO_RECLEN . . . . .	502
Propagating environment variables . . . . .	502

## Chapter 33. Using hardware built-in functions . . . . . 505

General instructions . . . . .	505
PLO - Perform Locked Operation available in ARCH(5) . . . . .	523
Decimal instructions . . . . .	528
Floating-point support instructions . . . . .	533
Decimal floating-point built-in functions . . . . .	534
Macros for use with decimal floating-point built-in functions . . . . .	542
Hexadecimal floating-point instructions . . . . .	544
Binary floating-Point instructions . . . . .	545
Built-in functions for transaction execution . . . . .	547

## Chapter 34. Using runtime check library . . . . . 551

## Chapter 35. Using vector programming support. . . . . 553

Options . . . . .	553
Macro . . . . .	553
Vector data types . . . . .	554
Language extensions . . . . .	555
Vector literals . . . . .	555
Initialization of vectors . . . . .	558
typedef definitions for vector types . . . . .	559
Pointers . . . . .	559
Unary expressions . . . . .	559
Binary expressions . . . . .	561
Cast expressions . . . . .	576
Compound literal expressions . . . . .	576
Other extensions for vector types . . . . .	576
Vector built-in functions . . . . .	577
Header file . . . . .	577
Summary of vector built-in functions . . . . .	577
Arithmetic . . . . .	584
Compare . . . . .	599
Compare Ranges . . . . .	606
Find Any Element . . . . .	617
Gather and Scatter . . . . .	625
Generate Mask . . . . .	631
Copy until Zero . . . . .	633
Load and Store . . . . .	634
Logical . . . . .	637
Merge . . . . .	640
Pack and Unpack . . . . .	641
Replicate . . . . .	645
Rotate and Shift . . . . .	648
Rounding and Conversion . . . . .	656
Test . . . . .	659
All Predicates . . . . .	660
Any Predicates . . . . .	668
Defining vector built-in functions from the operators . . . . .	674



**Chapter 36. ANSI C/C++ 98 applications and C99 . . . . . 677**

Obtaining C99 behavior with XL C . . . . . 677  
Using C99 functions in XL C++ applications . . . 677  
    Feature test macros that control C99 interfaces  
    in XL C++ applications . . . . . 677  
    Using C99 functions in C++ applications when  
    ambiguous definitions exist. . . . . 678

**Chapter 37. Writing applications for Single UNIX Specification, Version 3 . 681**

Announcing your intentions . . . . . 681  
Testing the environment . . . . . 682  
What is different in SUSv3 . . . . . 683  
Symbols withdrawn in SUSv3 . . . . . 684  
Candidates for removal in a future version . . . 684  
Implementation compliance . . . . . 684

**Chapter 38. Saved compile-time options information. . . . . 687**

Saved options information layout . . . . . 688

---

**Part 5. Performance optimization 693**

**Chapter 39. Improving program performance. . . . . 695**

Writing code for performance . . . . . 695  
Using C++ constructs in performance-critical code 695  
Using explicit instantiation declarations (C++11  
only) . . . . . 697  
ANSI aliasing rules . . . . . 697  
Using ANSI aliasing rules . . . . . 699  
Using variables. . . . . 701  
Passing function arguments . . . . . 702  
Coding expressions . . . . . 703  
Coding conversions . . . . . 704  
Arithmetical considerations. . . . . 704  
Using loops and control constructs . . . . . 704  
Choosing a data type. . . . . 705  
Using library extensions. . . . . 707  
Using #pragmas . . . . . 708  
Using rvalue references (C++11) . . . . . 710  
Using shared-memory parallelism (SMP) . . . . 712

**Chapter 40. Using built-in functions to improve performance . . . . . 715**

\_\_builtin\_expect . . . . . 716  
Platform-specific functions . . . . . 716  
Examples. . . . . 717

**Chapter 41. I/O Performance considerations . . . . . 719**

Accessing MVS data sets . . . . . 719  
Accessing UNIX file system files . . . . . 721  
Using memory files . . . . . 721  
Using the C++ I/O stream libraries . . . . . 721

**Chapter 42. Improving performance with compiler options. . . . . 723**

Using the OPTIMIZE option . . . . . 723  
Optimizations performed by the compiler . . . . 723  
    Aggressive optimizations with OPTIMIZE(3) 724  
Additional options that affect performance . . . 725  
    ANSIALIAS . . . . . 725  
    ARCHITECTURE and TUNE . . . . . 725  
    ASSERT(RESTRICT) . . . . . 726  
    COMPRESS . . . . . 726  
    COMPACT . . . . . 726  
    CVFT (C++ only) . . . . . 726  
    EXH (C++ only) . . . . . 726  
    EXPORTALL . . . . . 726  
    HGPR . . . . . 726  
    HOT . . . . . 726  
    IGNERRNO . . . . . 726  
    IPA . . . . . 727  
    LIBANSI . . . . . 727  
    OBJECTMODEL (C++ only) . . . . . 727  
    PREFETCH . . . . . 727  
    RESTRICT . . . . . 727  
    ROCONST . . . . . 727  
    ROSTRING . . . . . 728  
    RTTI . . . . . 728  
    SPILL . . . . . 728  
    STRICT . . . . . 728  
    STRICT\_INDUCTION . . . . . 728  
    THREADED. . . . . 728  
    UNROLL. . . . . 728  
Inlining . . . . . 728  
    Selectively marking code to inline . . . . . 729  
    Automatically choosing functions to inline . 730  
    Modifying automatic inlining choices . . . . 730  
    Overriding inlining defaults . . . . . 731  
    Inlining under IPA . . . . . 731  
Using the XPLINK option . . . . . 731  
    When you should not use XPLINK . . . . . 732  
Using the IPA option . . . . . 732  
    Types of procedural analysis . . . . . 733  
    Program-directed feedback . . . . . 734  
    Compiler processing flow . . . . . 735

**Chapter 43. Using high performance libraries. . . . . 741**

Using the Mathematical Acceleration Subsystem  
(MASS) libraries . . . . . 741  
    Using the MASS scalar library. . . . . 741  
    Using the MASS vector library . . . . . 744  
    Using the MASS SIMD library. . . . . 748  
    Compiling and linking a program with MASS 749  
Using the Automatically Tuned Linear Algebra  
Software (ATLAS) libraries . . . . . 753  
    Description and functionality provided. . . . 753  
    Supplied ATLAS libraries and their  
    corresponding header files . . . . . 754  
    Required compiler options . . . . . 755  
    Examples - Compiling, linking, and running a  
    simple matrix multiplication ATLAS program . 755

Examples - Compiling, linking, and running a complex ATLAS sample . . . . .	762
Related external information . . . . .	763

**Chapter 44. Parallelizing your programs . . . . . 765**

Using OpenMP directives . . . . .	765
Shared and private variables in a parallel environment. . . . .	766
OpenMP runtime functions for parallel processing	768

**Chapter 45. Optimizing the system and Language Environment . . . . . 777**

Improving the performance of the Language Environment . . . . .	777
Storing libraries and modules in system memory . . . . .	777
Optimizing memory and storage . . . . .	777
Optimizing runtime options . . . . .	778
Tuning the system for efficient execution . . . . .	779
Link pack areas . . . . .	779
Library lookasides. . . . .	779
Virtual lookasides . . . . .	779

**Chapter 46. Balancing compilation time and application performance . . . 781**

General tips . . . . .	781
Programmer tips . . . . .	782
System programmer tips . . . . .	783

**Chapter 47. Stepping through optimized code using the dbx debugger utility . . . . . 785**

Steps for setting up a stopping point for dbx in optimized code. . . . .	785
Steps for setting up a stopping point for dbx in optimized code. . . . .	785

**Part 6. z/OS XL C/C++ Environments . . . . . 787**

**Chapter 48. Using the system programming C facilities . . . . . 789**

Using functions in the system programming C environment. . . . .	790
System programming C facility considerations and restrictions . . . . .	791
Creating freestanding applications . . . . .	792
Creating modules without CEESTART . . . . .	793
Including an alternative initialization routine under z/OS . . . . .	793
Initializing a freestanding application without Language Environment. . . . .	793
Initializing a freestanding application using C functions . . . . .	794
Setting up a C environment with preallocated stack and heap . . . . .	794
Determining ISA requirements. . . . .	795

Building freestanding applications to run under z/OS . . . . .	795
Parts used for freestanding applications . . . . .	798
Creating system exit routines . . . . .	798
Building system exit routines under z/OS. . . . .	799
An example of a system exit . . . . .	799
Creating and using persistent C environments . . . . .	802
Building applications that use persistent C environments . . . . .	803
An example of persistent C environments . . . . .	803
Developing services in the service routine environment. . . . .	807
Using application service routine control flow	808
Understanding the stub perspective . . . . .	813
Establishing a server environment . . . . .	821
Initiating a server request . . . . .	822
Accepting a request for service . . . . .	822
Returning control from service . . . . .	822
Constructing user-server stub routines . . . . .	822
Building user-server environments . . . . .	822
Tailoring the system programming C environment	823
Generating abends . . . . .	823
Getting storage. . . . .	824
Getting page-aligned storage . . . . .	825
Freeing storage. . . . .	826
Loading a module. . . . .	826
Deleting a module. . . . .	826
Including a runtime message file . . . . .	827
Additional library routines . . . . .	828
Summary of application types. . . . .	828

**Chapter 49. Library functions for system programming C . . . . . 831**

__xhotc() — Set Up a Persistent C Environment (No Library). . . . .	831
__xhotl() — Set Up a Persistent C Environment (With Library) . . . . .	832
__xhott() — Terminate a Persistent C Environment	832
__xhotu(). . . . .	833
__xregs() — Get Registers on Entry . . . . .	833
__xsacc() — Accept Request for Service. . . . .	834
__xsrv() — Return Control from Service . . . . .	835
__xusr() - __xusr2() — Get Address of User Word	835
__24malc() — Allocate Storage below 16MB Line	835
__4kmalc() — Allocate Page-Aligned Storage. . . . .	836

**Chapter 50. Using runtime user exits 837**

Using runtime user exits in z/OS Language Environment . . . . .	837
Understanding the basics . . . . .	837
PL/I and C/370 compatibility. . . . .	837
User exits supported under z/OS Language Environment . . . . .	838
Order of processing of user exits . . . . .	838
Using installation-wide or application-specific user exits. . . . .	839
Using the Assembler user exit . . . . .	840
Using sample Assembler user exits . . . . .	840
Assembler user exit interface . . . . .	842
Parameter values in the Assembler user exit . . . . .	846

PL/I and C/370 compatibility . . . . .	851	Link considerations for C programs . . . . .	902
High level language user exit interface . . . . .	852	CSD considerations . . . . .	902
		Sample JCL to install z/OS XL C/C++ application programs . . . . .	902
<b>Chapter 51. Using the z/OS XL C MultiTasking Facility . . . . . 855</b>			
Organizing a program with MTF . . . . .	855	<b>Chapter 53. Using Cross System Product (CSP) . . . . . 905</b>	
Ensuring computational independence . . . . .	856	Common data types . . . . .	905
Running a C program without MTF . . . . .	857	Passing control . . . . .	905
Running a C program with MTF . . . . .	858	Running CSP under MVS . . . . .	906
Running a C program with one parallel function	858	Calling CSP applications from z/OS XL C . . . . .	906
Running a C program with two different parallel functions . . . . .	860	Calling z/OS XL C from CSP . . . . .	909
z/OS XL C with multiple instances of the same parallel function . . . . .	861	Running under CICS control . . . . .	913
Designing and coding applications for MTF . . . . .	863	Example programs . . . . .	913
Step 1: Identifying computationally-independent code . . . . .	863	<b>Chapter 54. Using Data Window Services (DWS) . . . . . 919</b>	
Step 2: Creating parallel functions . . . . .	863	<b>Chapter 55. Using DB2 Universal Database . . . . . 921</b>	
Step 3: Inserting calls to parallel functions . . . . .	867	Preparing an XL C/C++ application to request DB2 services . . . . .	921
Changing an application to use MTF . . . . .	867	Using the XL C/C++ DB2 coprocessor . . . . .	921
Changing the application to use MTF . . . . .	867	Using the DB2 C/C++ precompiler . . . . .	922
Compiling and linking programs that use MTF . . . . .	872	Using DB2 services and stored procedures with XPLINK . . . . .	922
Creating the main task program load module . . . . .	872	Examples of how to use XL C/C++ programs to request DB2 services . . . . .	923
Creating the parallel functions load module . . . . .	873	<b>Chapter 56. Using Graphical Data Display Manager (GDDM) . . . . . 929</b>	
Specifying the linkage-editor option . . . . .	874	Examples . . . . .	930
Modifying runtime options . . . . .	874	<b>Chapter 57. Using the Information Management System (IMS) . . . . . 935</b>	
Running programs that use MTF . . . . .	874	Handling errors . . . . .	936
STEPLIB DD statement . . . . .	874	Other considerations . . . . .	936
DD statements for standard streams . . . . .	874	Examples . . . . .	937
Example of JCL . . . . .	875	<b>Chapter 58. Using the Query Management Facility (QMF) . . . . . 943</b>	
Debugging programs that use MTF . . . . .	875	Example programs . . . . .	943
Avoiding undesirable results when using MTF . . . . .	875	<b>Part 8. Internationalization: Locales and Character Sets . . . . . 949</b>	
<hr/>			
<b>Part 7. Programming with Other Products . . . . . 877</b>			
<hr/>			
<b>Chapter 52. Using the CICS Transaction Server (CICS TS) . . . . . 879</b>			
Developing XL C/C++ programs for the CICS environment . . . . .	879	<b>Chapter 59. Introduction to locale . . . . . 951</b>	
Preparing CICS for use with z/OS Language Environment . . . . .	879	Internationalization in programming languages . . . . .	951
Designing and coding for CICS . . . . .	880	Elements of internationalization . . . . .	951
Using the CICS command-level interface . . . . .	880	z/OS XL C/C++ Support for internationalization . . . . .	952
Using input and output . . . . .	884	Locales and localization . . . . .	952
Using z/OS XL C/C++ library support . . . . .	886	Locale-sensitive interfaces . . . . .	952
Storage management . . . . .	888	<b>Chapter 60. Building a locale. . . . . 955</b>	
Using ILC support . . . . .	889	Limitations of enhanced ASCII . . . . .	955
Exception handling . . . . .	889	Using the charmap file . . . . .	956
Example of error handling in CICS . . . . .	890	The CHARMAP section . . . . .	961
ABEND codes and error messages under z/OS XL C/C++ . . . . .	894		
Coding hints and tips . . . . .	894		
Translating and compiling for reentrancy . . . . .	894		
Options for translating CICS statements . . . . .	894		
Compiling XL C/C++ programs that were preprocessed by the standalone CICS translator . . . . .	899		
Prelinking and linking all object modules . . . . .	900		
Defining and running the CICS program . . . . .	902		
Program processing . . . . .	902		

The CHARSETID section . . . . .	963
Locale source files . . . . .	964
LC_CTYPE category . . . . .	967
LC_COLLATE category . . . . .	970
LC_MONETARY category . . . . .	977
LC_NUMERIC category . . . . .	980
LC_TIME category . . . . .	981
LC_MESSAGES category . . . . .	983
LC_TOD category . . . . .	984
LC_SYNTAX category . . . . .	986
Method files . . . . .	989
Using the localedef utility . . . . .	993
Locale naming conventions . . . . .	994

<b>Chapter 61. Customizing a locale</b>	<b>1005</b>
Using the customized locale . . . . .	1007
Referring explicitly to a customized locale . . . . .	1008
Referring implicitly to a customized locale . . . . .	1009
Customizing your installation . . . . .	1011

<b>Chapter 62. Customizing a time zone</b>	<b>1013</b>
Using the TZ or _TZ environment variable to specify time zone. . . . .	1013
Relationship between TZ or _TZ and LC_TOD . . . . .	1014

<b>Chapter 63. Definition of S370 C, SAA C, and POSIX C locales</b>	<b>1015</b>
Differences between SAA C and POSIX C locales . . . . .	1021

<b>Chapter 64. Code set conversion utilities</b>	<b>1023</b>
The genxlt utility . . . . .	1023
The iconv utility . . . . .	1023
Code conversion functions . . . . .	1024
_ICONV_MODE environmental variable . . . . .	1025
_ICONV_TECHNIQUE environmental variable . . . . .	1025
Code set converters supplied . . . . .	1026
Universal coded character set converters . . . . .	1035
Codeset conversion using UCS-2 . . . . .	1042
UCMAP source format . . . . .	1043

<b>Chapter 65. Coded character set considerations with locale functions</b>	<b>1047</b>
Variant character detail . . . . .	1047
Alternate code points . . . . .	1049
Coding without locale support by using a hybrid coded character set . . . . .	1049
Writing code using a hybrid coded character set . . . . .	1051
Converting hybrid code . . . . .	1051
Coded character set independence in developing applications . . . . .	1051
Coded character set in source code and header files . . . . .	1053
Converting coded character sets at compile time . . . . .	1056
Writing source code in coded character set IBM-1047 . . . . .	1062
Exporting source code to other sites . . . . .	1062

Converting existing work . . . . .	1063
Considerations with other products and tools . . . . .	1064

<b>Chapter 66. Bidirectional language support</b>	<b>1065</b>
Bidirectional languages . . . . .	1065
Overview of the layout functions . . . . .	1066
Using the layout functions . . . . .	1071

---

## **Part 9. Appendixes . . . . . 1077**

<b>Appendix A. POSIX character set</b>	<b>1079</b>
--	-------------

<b>Appendix B. Mapping variant characters for z/OS XL C/C++</b>	<b>1083</b>
Specifying the appropriate code page for the compiler . . . . .	1083
Testing the display of variant characters . . . . .	1083
Inserting and viewing square brackets during an ISPF edit session . . . . .	1086

<b>Appendix C. z/OS XL C/C++ code point mappings</b>	<b>1089</b>
--	-------------

<b>Appendix D. Locales supplied with z/OS XL C/C++</b>	<b>1091</b>
Compiled locales . . . . .	1091
Locale source files . . . . .	1111

<b>Appendix E. Charmap files supplied with z/OS XL C/C++</b>	<b>1117</b>
--	-------------

<b>Appendix F. Examples of charmap and locale definition source</b>	<b>1121</b>
Charmap file . . . . .	1121
Locale definition source file . . . . .	1126
Locale method source file . . . . .	1131

<b>Appendix G. Converting hybrid code to a specific character set</b>	<b>1133</b>
Sample program . . . . .	1133

<b>Appendix H. Additional Examples</b>	<b>1141</b>
Memory Management . . . . .	1141
Calling MVS WTO routines from C. . . . .	1148
Listing Partitioned Data Set Members . . . . .	1150

<b>Appendix I. Application considerations for z/OS UNIX XL C/C++</b>	<b>1155</b>
Relationship to DB2 universal database . . . . .	1155
Application programming environments not supported . . . . .	1155
Support for the Curses library . . . . .	1155

**Appendix J. External variables . . . 1157**

errno . . . . . 1157  
daylight . . . . . 1158  
getdate\_err . . . . . 1158  
h\_errno . . . . . 1158  
\_\_loc1 . . . . . 1158  
loc1 . . . . . 1158  
loc2 . . . . . 1159  
locs . . . . . 1159  
optarg . . . . . 1159  
opterr . . . . . 1159  
optind . . . . . 1159  
optopt . . . . . 1159  
siggam . . . . . 1159  
stdin . . . . . 1159  
stderr . . . . . 1159  
stdout . . . . . 1160  
t\_errno . . . . . 1160  
timezone . . . . . 1160  
tzname . . . . . 1160

**Appendix K. Packaging considerations . . . . . 1161**

Compiler options . . . . . 1161

Libraries . . . . . 1161  
Prelinking . . . . . 1162  
Linking . . . . . 1162

**Appendix L. Accessibility . . . . . 1165**

Accessibility features . . . . . 1165  
Consult assistive technologies . . . . . 1165  
Keyboard navigation of the user interface . . . . . 1165  
Dotted decimal syntax diagrams . . . . . 1165

**Notices . . . . . 1169**

Policy for unsupported hardware . . . . . 1170  
Minimum supported hardware . . . . . 1171  
Permission Notice . . . . . 1171  
Programming interface information . . . . . 1171  
Trademarks . . . . . 1172  
Standards . . . . . 1172

**Bibliography . . . . . 1175**

**Index . . . . . 1177**





---

## Figures

1. Blocking fixed-length records . . . . .	13	50. Intermediate C routine calling a runtime library function . . . . .	256
2. Variable-length records on z/OS . . . . .	17	51. Establishing the XL C/C++ runtime environment . . . . .	257
3. Memory file example . . . . .	31	52. Calling an intermediate XL C/C++ function from Assembler using OS linkage . . . . .	257
4. ASA Example . . . . .	48	53. Intermediate XL C/C++ routine calling a runtime library function . . . . .	257
5. ungetwc() Example . . . . .	59	54. Interface for preinitializable programs	260
6. Interleaving I/O with sync_with_stdio() . . . . .	65	55. Preinitializing a C program (CCNGCA6)	264
7. Interleaving I/O without sync_with_stdio() . . . . .	67	56. Using the preinitializable program (CCNGCA7) . . . . .	266
8. MVS example of redirecting three standard streams by ddnames . . . . .	73	57. Using the preinitializable program (CCNGCA8) . . . . .	267
9. Example of using stdout and stderr to share the same file . . . . .	74	58. JCL for running a preinitializable C program	269
10. Example of passing text streams . . . . .	76	59. Explicit use of a DLL in an application using the dllload() family of functions . . . . .	285
11. Example of passing record I/O streams	78	60. Explicit use of a DLL in an application using the dlopen() family of functions . . . . .	287
12. Example of command line redirection . . . . .	81	61. Using #pragma export to create a DLL executable module named BASICIO . . . . .	291
13. Generation data group example for C . . . . .	88	62. Using #pragma export to create the triangle DLL executable module . . . . .	292
14. Generation data group example for C++	89	63. Using _Export to create the triangle DLL executable module . . . . .	292
15. How the operating system completes the DCB . . . . .	104	64. Summary of DLL and DLL application preparation and usage . . . . .	297
16. Example of reading updated records . . . . .	113	65. Referencing functions and external variables in DLL code . . . . .	306
17. Example of signal handler . . . . .	122	66. Pointer Assignment in DLL code . . . . .	307
18. fldata() Structure . . . . .	124	67. Pointer assignment in non-DLL code	308
19. Unnamed pipes example . . . . .	137	68. File 1. Application A . . . . .	309
20. Named pipes example . . . . .	139	69. File 2. Application A . . . . .	309
21. Example of z/OS UNIX stream input and output functions . . . . .	142	70. File 3. Application B . . . . .	310
22. Example of HFS stream input and output functions . . . . .	146	71. File 4. DLL . . . . .	310
23. fldata() structure . . . . .	148	72. DLL function pointer call in non-DLL code	311
24. Types and advantages of VSAM data sets	153	73. DLL function pointer call in non-DLL code	312
25. VSAM example . . . . .	155	74. C non-DLL code . . . . .	313
26. KSDS example . . . . .	179	75. C DLL code . . . . .	314
27. KSDS example . . . . .	184	76. C++ DLL code . . . . .	314
28. RRDS example . . . . .	187	77. C++ DLL code calling an Assembler function	314
29. fldata() structure . . . . .	189	78. Comparison of function pointers in non-DLL code . . . . .	315
30. fldata() structure . . . . .	199	79. C DLL code . . . . .	315
31. Removing members of a PDS . . . . .	207	80. C non-DLL code . . . . .	315
32. Renaming members of a PDS . . . . .	208	81. File 1 C DLL code . . . . .	316
33. fldata() structure . . . . .	213	82. File 2 C DLL code . . . . .	316
34. Memory file example, part 1 . . . . .	214	83. File 3 C non-DLL code . . . . .	316
35. Memory file example, part 2 . . . . .	214	84. Comparison of two DLL function pointers in non-DLL code . . . . .	316
36. fldata() structure . . . . .	220	85. Undefined comparison in DLL code (C or C++) . . . . .	318
37. fldata() example . . . . .	221	86. Comparison of function pointers in DLL code (C or C++) . . . . .	318
38. CELQPIPI MSGRTN example . . . . .	221	87. Valid comparisons in DLL code (C or C++)	319
39. __amrc structure . . . . .	223	88. Application CCNGA2. . . . .	320
40. Example of printing the __amrc structure	226		
41. __amrc2 structure . . . . .	227		
42. Example of using SIGIOERR . . . . .	232		
43. Sample File I/O Trace. . . . .	234		
44. Example of parameter lists For OS linkages	247		
45. EDCXPRLG macro with an ALIAS statement	252		
46. Call to an XPLINK routine with no parameters . . . . .	253		
47. Call to an XPLINK routine with 5 parameters	254		
48. Establishing the C runtime environment	255		
49. Calling an intermediate C function from Assembler OS linkage. . . . .	256		

89.	Application CCNGA2D1 . . . . .	320	135.	An application using select() . . . . .	442
90.	Application CCNGA2D2 . . . . .	321	136.	An Application Using ioctl() . . . . .	443
91.	Application CCNGA2D3 . . . . .	321	137.	An application using close(). . . . .	443
92.	CCNGA2M1 . . . . .	322	138.	A conceptual overview of the compile, bind, and run steps . . . . .	445
93.	CCNGA2M2 . . . . .	323	139.	stackadd.cpp file (ccntmp3.cpp) . . . . .	459
94.	Comparison of struct li, alignments under ILP32 and LP64 . . . . .	335	140.	stackops.cpp file (ccntmp4.cpp) . . . . .	459
95.	Comparison of struct lii alignments under ILP32 and LP64 . . . . .	336	141.	stack.h file (ccntmp2.h) . . . . .	459
96.	Comparison of struct ili alignments under ILP32 and LP64 . . . . .	337	142.	stack.c file (ccntmp1.c) . . . . .	460
97.	Example of potential alignment problems when a struct is shared or exchanged among 32-bit and 64-bit processes . . . . .	346	143.	stackops.h File (ccntmp5.h) . . . . .	460
98.	Example of user-defined data padding for a structure that is shared or exchanged among 32-bit and 64-bit processes . . . . .	350	144.	JCL to compile source Files and TEMPINC destination . . . . .	460
99.	Referring to thread-specific data . . . . .	360	145.	z/OS UNIX Syntax . . . . .	461
100.	Controlling external static . . . . .	371	146.	Simple and typical use of explicit instantiation declarations. . . . .	464
101.	Making strings constant . . . . .	372	147.	Erroneous use of explicit instantiation declarations . . . . .	465
102.	Example of controlling the memory area . . . . .	372	148.	_CEE_RUNOPTS behaviour. . . . .	485
103.	How to Make String Literals Modifiable . . . . .	373	149.	Environment variables example-Part 1 . . . . .	503
104.	Referencing objects in the writable static area, Part 1 . . . . .	374	150.	Environment variables example-Part 2 . . . . .	503
105.	Referencing objects in the writable static area, Part 2 . . . . .	375	151.	z/Architecture FPC register-rounding mode definitions . . . . .	542
106.	Arithmetic operators example . . . . .	381	152.	Biased exponent type definitions . . . . .	543
107.	Relational operators example . . . . .	382	153.	Test Data Class masks . . . . .	543
108.	Getting the total number of bytes occupied by the decimal data type . . . . .	384	154.	Test Data Group masks . . . . .	544
109.	Getting the total number of digits in the decimal data type . . . . .	384	155.	Even multiply of 4 integer elements (16-bit) . . . . .	593
110.	Getting the number of decimal digits in the decimal data type . . . . .	385	156.	Odd multiply of 4 integer elements (16-bit) . . . . .	595
111.	Fractional part cannot be represented . . . . .	386	157.	Two sums in the 4 unsigned integer elements (32-bit). . . . .	598
112.	Integral part cannot be represented . . . . .	387	158.	Permute 16 integer elements (8-bit) . . . . .	628
113.	Conversion to integer type . . . . .	387	159.	Merge 2 high-order elements (32-bit) . . . . .	640
114.	Conversion from integral type . . . . .	388	160.	Merge 2 low-order elements (32-bit) . . . . .	641
115.	Conversion to floating-point type . . . . .	389	161.	Pack 8 integer elements (32-bit) to 8 integer elements (16-bit) . . . . .	642
116.	Conversion from floating-point type . . . . .	389	162.	Pack 8 integer elements (32-bit) to 8 integer elements (16-bit) . . . . .	642
117.	Decimal type — Example 1 . . . . .	392	163.	Unpack high-order integer elements (16-bit) to integer elements (32-bit) . . . . .	644
118.	Output produced by CCNGDC3 . . . . .	393	164.	Unpack low-order integer elements (16-bit) to integer elements (32-bit) . . . . .	645
119.	Decimal type — example 2 . . . . .	394	165.	Bit-wise conditional select of vector contents (128-bit) . . . . .	650
120.	Output produced by CCNGDC4 . . . . .	394	166.	Example of code that requires the global namespace syntax . . . . .	679
121.	Example illustrating C++ exception handling/traceback . . . . .	405	167.	Definition of saved options information layout . . . . .	688
122.	Example illustrating C++ exception handling/traceback . . . . .	406	168.	Numeric conversions example . . . . .	704
123.	Example illustrating signal handling . . . . .	424	169.	Example of using OPTIMIZE(2) . . . . .	725
124.	An electrical analogy showing the socket concept . . . . .	427	170.	Flow of regular compiler processing . . . . .	735
125.	A typical stream socket session . . . . .	436	171.	IPA compile step processing . . . . .	736
126.	A typical datagram socket session. . . . .	437	172.	IPA link step processing . . . . .	737
127.	An application using socket() . . . . .	438	173.	Specifying alternative initialization at link edit . . . . .	793
128.	An application using bind(). . . . .	438	174.	Sample Freestanding z/OS Routine . . . . .	796
129.	A bind() function using gethostbyname() . . . . .	439	175.	Link edit control statements used to build a freestanding z/OS routine . . . . .	796
130.	An application using listen() . . . . .	439	176.	Compile and link using EDCCCL . . . . .	796
131.	An application using connect(). . . . .	440	177.	Sample reentrant freestanding z/OS routine . . . . .	797
132.	An application using accept() . . . . .	440	178.	Building and running a reentrant freestanding z/OS routine. . . . .	797
133.	An application using send() and recv() . . . . .	441	179.	System exit example . . . . .	800
134.	An application using sendto() and recvfrom() . . . . .	441			

180. Example of function used in a persistent C environment . . . . .	804	227. z/OS XL C transferring control to CSP under TSO using the XFER/DXFR statement . . . . .	908
181. Using a persistent C environment. . . . .	805	228. CSP CALLing z/OS XL C under TSO . . . . .	910
182. Example of user routine . . . . .	809	229. CSP transferring control to z/OS XL C under TSO using the XFER statement. . . . .	911
183. Example of application service routine . . . . .	810	230. CSP CALLing z/OS XL C under CICS . . . . .	913
184. Example of server initialization stub . . . . .	814	231. CSP transferring control to z/OS XL C under CICS using the XFER statement . . . . .	914
185. Example of server message stub-LIFO . . . . .	816	232. CSP Transferring Control to z/OS XL C under CICS Using the DXFR Statement . . . . .	916
186. Example of server message stub-FIFO . . . . .	817	233. Example using DWS and C++ . . . . .	919
187. Example of server message stub-GET . . . . .	819	234. z/OS XL C/C++ Using Data Window Services . . . . .	920
188. Example of server message stub-TERM . . . . .	820	235. Using DB2 with C . . . . .	924
189. Example of routine to generate abend . . . . .	824	236. Using DB2 with C/C++ . . . . .	926
190. Example of routine to get storage . . . . .	825	237. Example using GDDM and C . . . . .	930
191. Example of routine to free storage . . . . .	826	238. Example using GDDM and C++ . . . . .	932
192. Location of user exits . . . . .	838	239. C++ Program using IMS . . . . .	937
193. Interface for Assembler user exits . . . . .	843	240. C Program using IMS. . . . .	939
194. CEEAUE_FLAGS format. . . . .	844	241. Header file for IMS example . . . . .	940
195. Exit_list and hook_exit control blocks . . . . .	853	242. QMF interface example . . . . .	943
196. Computational independence . . . . .	856	243. C++ Calling a C program that accesses QMF . . . . .	945
197. Example of a C program running without MTF . . . . .	857	244. C program that accesses QMF . . . . .	946
198. Example of a C program running without MTF (Part 2). . . . .	858	245. Conceptual model of the locale build process . . . . .	955
199. Processor usage with one parallel function . . . . .	859	246. Example locale source containing header, body, and trailer . . . . .	965
200. Sample program using one parallel function . . . . .	860	247. Example LC_CTYPE definition. . . . .	970
201. Processor usage with two parallel function . . . . .	860	248. Example LC_COLLATE definition . . . . .	975
202. Sample program using two parallel functions . . . . .	861	249. Example LC_MONETARY definition . . . . .	980
203. Processor use with multiple instances of the same parallel function . . . . .	862	250. Example LC_NUMERIC definition . . . . .	981
204. Sample program using multiple instances of the same parallel function . . . . .	863	251. Example LC_MESSAGES definition . . . . .	984
205. Basic MTF layout . . . . .	865	252. Example LC_TOD definition . . . . .	986
206. Identifying Computationally-Independent Code . . . . .	868	253. Example definition of LC_SYNTAX . . . . .	988
207. Sample code as a parallel function . . . . .	868	254. Expected grammar for method files . . . . .	990
208. Scheduling instances of a parallel function . . . . .	869	255. Referring explicitly to a customized locale . . . . .	1008
209. Main task program to call dot product function . . . . .	869	256. Referring implicitly to a customized locale . . . . .	1009
210. Sample code to be changed to use MTF . . . . .	870	257. Using environment variables to select a locale . . . . .	1010
211. Sample code (main routine). . . . .	871	258. Additional locale categories for POSIX C . . . . .	1016
212. Sample code (routine to create parallel functions). . . . .	872	259. Determining which locale is in effect . . . . .	1022
213. Sample JCL to compile and link main task program . . . . .	873	260. Supplied code set converters . . . . .	1026
214. Sample JCL to compile and link parallel functions . . . . .	873	261. Example of hybrid coded character set . . . . .	1050
215. Source code for EDCMTFS . . . . .	874	262. Compile-edit, related to locale function . . . . .	1052
216. Example runtime JCL . . . . .	875	263. Example of __CODESET__ macro . . . . .	1055
217. Example illustrating how to use EXEC CICS commands . . . . .	882	264. Values of macros __FILETAG__, __LOCALE__, and __CODESET__ . . . . .	1056
218. Format of data written to a CICS data queue . . . . .	885	265. Using the CONVLIT compiler option . . . . .	1057
219. Example illustrating error handling under CICS . . . . .	891	266. Example of output when locale option is used . . . . .	1060
220. Example illustrating how to use EXEC CICS commands . . . . .	896	267. Using the pragma convert directive . . . . .	1062
221. Child C program after translation. . . . .	897	268. Example of using a layout string modifier . . . . .	1071
222. JCL to translate and compile a C program . . . . .	900	269. Example of using the m_setvalues_layout() function . . . . .	1071
223. JCL to translate and compile a C++ program . . . . .	900	270. Example of bidirectional layout API's . . . . .	1075
224. Prelinking and linking . . . . .	901	271. Variant characters. . . . .	1084
225. JCL to install z/OS XL C/C++ application programs . . . . .	902	272. CCNGMV1: Displaying hexadecimal values . . . . .	1085
226. C/370 CALLing CSP under TSO . . . . .	906	273. Sample ISPF macro for displaying square brackets . . . . .	1087
		274. Coded character set for Latin 1/Open systems . . . . .	1089
		275. Coded character set for APL . . . . .	1090

276. Charmap file . . . . .	1121	281. Main routine - debuggable	
277. Example locale definition source file . . . . .	1127	malloc()/calloc()/realloc()/free() example . . . . .	1142
278. Example locale method source file . . . . .	1132	282. Performing a Write To Operator . . . . .	1149
279. Converting hybrid C syntax from code page		283. Performing a Write To Operator . . . . .	1150
IBM-1047 . . . . .	1133	284. Example of Listing All Members of a PDS . . . . .	1151
280. Debuggable malloc()/calloc()/realloc()/free()		285. ccngip2.h Header file . . . . .	1154
example . . . . .	1141		

---

## Tables

1. Syntax examples . . . . .	xxvi	45. Summary of DLL concepts and terms	282
2. z/OS XL C/C++ and related documents	xxviii	46. Example programs to demonstrate compiling options . . . . .	304
3. Documents by task . . . . .	xxxi	47. Examples of how to compile two source modules and list result . . . . .	304
4. C control to ASA characters . . . . .	15	48. Referencing functions and external variables	305
5. Summary of prototype functions . . . . .	27	49. Comparison of ILP32 and LP64 addressing capabilities . . . . .	325
6. Kinds of I/O supported by z/OS XL C/C++	29	50. Comparison of ILP32 and LP64 data models	325
7. I/O categories and environments that support them . . . . .	30	51. ILP32 and LP64 type size comparisons for signed and unsigned data types . . . . .	326
8. fopen() defaults for LRECL and BLKSIZE when creating OS files . . . . .	35	52. Example of diagnostic messages generated from code that is not ready to be migrated from ILP32 to LP64 . . . . .	329
9. C control to ASA characters translation table	47	53. Comparison of ILP32 and LP64 processing and runtime options . . . . .	332
10. Manipulating wide character arrays . . . . .	61	54. Comparison of data structure member lengths produced from the same code . . . . .	333
11. C standard streams . . . . .	63	55. Example of possible change of result after conversion from signed number to unsigned long . . . . .	338
12. C++ standard streams . . . . .	64	56. Example of possible change of result after conversion from unsigned int variable to signed long . . . . .	338
13. z/OS XL C/C++ Redirection symbols . . . . .	69	57. Example of possible change of result after conversion from signed long long variable to signed long . . . . .	339
14. Output destinations under z/OS XL C/C++	70	58. Example of possible change of result after conversion from unsigned long long variable to unsigned long . . . . .	339
15. z/OS XL C/C++ Interleaved output . . . . .	71	59. Example of possible change of result after conversion from signed long long variable to signed long . . . . .	340
16. Association of standard streams with ddnames	73	60. Example of possible change of result after conversion from unsigned long long variable to signed long . . . . .	341
17. Standard stream behavior differences . . . . .	79	61. Example of source code that explicitly converts an integer to a pointer . . . . .	342
18. PDSE and PDS differences . . . . .	90	62. Example of truncation problem with a pointer cast conversion . . . . .	343
19. Rules for possible concatenations . . . . .	91	63. Type of an integer constant . . . . .	344
20. Other devices supported for input and output	96	64. An attempt to share pointers between 32-bit and 64-bit processes . . . . .	344
21. Parameters for the fopen() and freopen() functions for z/OS OS I/O . . . . .	97	65. Example of unexpected behavior resulting from use of unsuffixed numbers . . . . .	346
22. fopen() defaults for LRECL and BLKSIZE when creating OS files . . . . .	104	66. Example of using LONG_MAX macros in a printf subroutine . . . . .	347
23. C control to ASA characters . . . . .	109	67. Example of source code that successfully shares pointers between ILP32 and LP64 programs . . . . .	349
24. Parameters for the fopen() and freopen() functions for z/OS UNIX file system I/O . . . . .	131	68. Functions used in creating multi-threaded applications . . . . .	353
25. Summary of VSAM data set characteristics and allowable I/O operations . . . . .	155	69. Functions to change default attributes	353
26. Keywords for the fopen() and freopen() functions for VSAM data sets . . . . .	159	70. Functions used to control individual threads in a multi-threaded environment . . . . .	354
27. Summary of VSAM record I/O operations	168		
28. AMODE31 application XADDR support	171		
29. Summary of fseek() and ftell() parameters in text and binary . . . . .	174		
30. Summary of VSAM text I/O operations	175		
31. Summary of VSAM binary I/O operations	176		
32. Keywords for the fopen() and freopen() functions for terminal I/O . . . . .	192		
33. Keywords for the fopen() and freopen() functions for memory file I/O . . . . .	203		
34. __last_op codes and diagnosis information	227		
35. Linkage used by C or C++ Interlanguage Programs . . . . .	240		
36. Comparison of non-XPLINK and XPLINK register conventions . . . . .	248		
37. Load service routine parameters . . . . .	273		
38. Delete service routine parameters . . . . .	274		
39. Get-storage service routine parameters	274		
40. Free-storage service routine parameters	275		
41. Exception router service routine parameters	275		
42. Attention router service routine parameters	277		
43. Attention handler parameters . . . . .	277		
44. Message router service routine parameters	278		



71. Functions that allow for synchronization between threads . . . . .	355	115. Accepted vector data types for remainder operator % . . . . .	563
72. Functions used with thread-specific data . . . . .	359	116. Accepted vector data types for addition operator + . . . . .	564
73. Cancellation point summary . . . . .	363	117. Accepted vector data types for subtraction operator - . . . . .	564
74. Functions used to control cancellability . . . . .	363	118. Accepted vector data types for bitwise left shift operator << . . . . .	565
75. Functions used for cleanup purposes . . . . .	364	119. Accepted vector data types for bitwise right shift operator >> . . . . .	566
76. Declarations of fixed-point decimal constants . . . . .	378	120. Accepted vector data types for relational less than operator < . . . . .	567
77. Examples of Fixed-Point decimal constants and their attributes . . . . .	378	121. Accepted vector data types for relational greater than operator > . . . . .	568
78. Intermediate results (without overflow in n or p) . . . . .	383	122. Accepted vector data types for relational less than or equal to operator <= . . . . .	569
79. Intermediate results (in the general form) . . . . .	383	123. Accepted vector data types for relational greater than or equal to operator >= . . . . .	570
80. Operators used with decimal data types . . . . .	385	124. Accepted vector data types for equality operator == . . . . .	570
81. C/C++ functions that support floating-point . . . . .	399	125. Accepted vector data types for inequality operator != . . . . .	571
82. Special purpose C/C++ functions that support floating-point. . . . .	402	126. Accepted vector data types for bitwise AND operator & . . . . .	572
83. Functions that establish a signal handler . . . . .	411	127. Accepted vector data types for bitwise exclusive OR operator ^ . . . . .	573
84. Other signal-related functions . . . . .	411	128. Accepted vector data types for bitwise inclusive OR operator   . . . . .	574
85. Hardware exceptions - Default runtime messages and system actions . . . . .	417	129. Vector built-in functions for arithmetic . . . . .	577
86. Software exceptions - Default runtime messages and system actions with POSIX(OFF) . . . . .	417	130. Vector built-in functions for comparing elements . . . . .	578
87. Default signal processing with POSIX(ON) . . . . .	419	131. Vector built-in functions for comparing ranges . . . . .	579
88. Original versions of fdlibm functions . . . . .	494	132. Vector built-in functions for element searching . . . . .	579
89. Standard general-instruction prototypes . . . . .	505	133. Vector built-in functions for gathering and scattering elements. . . . .	580
90. Built-in general-instruction prototypes . . . . .	507	134. Vector built-in functions for generating mask . . . . .	580
91. PLO helper macros . . . . .	525	135. Vector built-in functions for copying until a zero is encountered . . . . .	581
92. Compare and load prototypes . . . . .	526	136. Vector built-in functions for loading and storing vectors . . . . .	581
93. Compare and swap prototypes. . . . .	526	137. Vector built-in functions for logical calculation . . . . .	581
94. Double compare and swap prototypes . . . . .	527	138. Vector built-in functions for merging vectors . . . . .	581
95. Compare and swap and store prototypes . . . . .	527	139. Vector built-in functions for pack and unpack . . . . .	582
96. Compare swap and double store prototypes . . . . .	528	140. Vector built-in functions for replicating vector elements . . . . .	582
97. Compare and swap and triple store prototypes . . . . .	528	141. Vector built-in functions for rotate and shift . . . . .	582
98. Decimal instruction prototypes. . . . .	529	142. Vector built-in functions for rounding and conversion . . . . .	583
99. Floating-point instruction prototypes . . . . .	533	143. Vector built-in functions for testing . . . . .	583
100. Decimal floating-point instruction prototypes for IEEE operations . . . . .	534	144. Vector built-in functions for searching and comparing all elements . . . . .	583
101. Decimal floating-point instruction prototypes for IEEE . . . is operations . . . . .	536	145. Vector built-in functions for searching and comparing any elements . . . . .	584
102. Decimal floating-point instruction prototypes for IBM Instructions . . . . .	537	146. Vector Absolute Value. . . . .	584
103. Instruction prototypes for conversions between decimal floating-point and zoned types . . . . .	541	147. Vector Add unsigned 128-bits . . . . .	585
104. Hexadecimal floating-point instruction prototypes . . . . .	544	148. Vector Add Carryout . . . . .	585
105. Binary floating-point instruction prototypes . . . . .	545	149. Vector Add Compute Carryout unsigned 128-bits . . . . .	585
106. Built-in functions for transactional memory . . . . .	548	150. Vector Add With Carry unsigned 128-bits . . . . .	586
107. Vector data types . . . . .	554	151. Vector Add With Carry Compute Carry unsigned 128-bits . . . . .	586
108. Vector literals . . . . .	556		
109. Unary operators . . . . .	559		
110. Increment value for vec_step by data type . . . . .	561		
111. Binary operators . . . . .	561		
112. Relational operators . . . . .	562		
113. Accepted vector data types for multiplication operator * . . . . .	562		
114. Accepted vector data types for division operator / . . . . .	563		



152.	Vector AND With Complement . . . . .	586	203.	Vector Compare Ranges or Zero Index	616
153.	Vector Average . . . . .	587	204.	Vector Compare Ranges or Zero Index with Condition Code. . . . .	617
154.	Vector Checksum . . . . .	588	205.	Vector Find Any Element Equal . . . . .	617
155.	Vector Galois Field Multiply Sum . . . . .	588	206.	Vector Find Any Element Equal with Condition Code. . . . .	618
156.	Vector Galois Field Multiply Sum 128-bits	588	207.	Vector Find Any Element Equal Index	618
157.	Vector Galois Field Multiply Sum and Accumulate . . . . .	589	208.	Vector Find Any Element Equal Index with Condition Code. . . . .	619
158.	Vector Galois Field Multiply Sum and Accumulate 128-bits . . . . .	589	209.	Vector Find Any Element Equal or Zero Index	620
159.	Vector Multiply Add . . . . .	589	210.	Vector Find Any Element Equal or Zero Index with Condition Code . . . . .	621
160.	Vector Maximum . . . . .	590	211.	Vector Find Any Element Not Equal . . . . .	621
161.	Vector Multiply and Add Even. . . . .	590	212.	Vector Find Any Element Not Equal with Condition Code. . . . .	622
162.	Vector Multiply and Add High. . . . .	591	213.	Vector Find Any Element Not Equal Index	622
163.	Vector Minimum . . . . .	591	214.	Vector Find Any Element Not Equal Index with Condition Code . . . . .	623
164.	Vector Multiply and Add Low . . . . .	592	215.	Vector Find Any Element Not Equal or Zero Index . . . . .	624
165.	Vector Multiply and Add Odd . . . . .	593	216.	Vector Find Any Element Not Equal or Zero Index with Condition Code . . . . .	625
166.	Vector Multiply Subtract . . . . .	593	217.	Vector Extract . . . . .	625
167.	Vector Multiply Even . . . . .	594	218.	Vector Gather Element . . . . .	626
168.	Vector Multiply High . . . . .	594	219.	Vector Insert . . . . .	627
169.	Vector Multiply Odd . . . . .	595	220.	Vector Insert and Zero . . . . .	627
170.	Vector Negative Absolute . . . . .	595	221.	Vector Permute . . . . .	628
171.	Vector Square Root. . . . .	595	222.	Vector Permute Immediate . . . . .	629
172.	Vector Subtract unsigned 128-bits . . . . .	596	223.	Vector Promote . . . . .	629
173.	Vector Subtract Carryout. . . . .	596	224.	Vector Scatter Element . . . . .	630
174.	Vector Subtract Carryout unsigned 128-bits	596	225.	Vector Select . . . . .	630
175.	Vector Subtract with Carryout . . . . .	597	226.	Vector Generate Byte Mask . . . . .	631
176.	Vector Subtract with Carryout, Carryout	597	227.	Vector Generate Mask (Byte) . . . . .	632
177.	Vector Sum Across Quadword . . . . .	597	228.	Vector Generate Mask (Halfword). . . . .	632
178.	Vector Sum Across Doubleword . . . . .	598	229.	Vector Generate Mask (Word) . . . . .	632
179.	Vector Sum Across Word. . . . .	599	230.	Vector Generate Mask (Doubleword)	633
180.	Vector Compare Equal . . . . .	599	231.	Vector Copy Until Zero . . . . .	633
181.	Vector Compare Equal Index . . . . .	599	232.	Vector Copy Until Zero . . . . .	634
182.	Vector Compare Equal Index with Condition Code . . . . .	600	233.	Vector Load 2 float. . . . .	634
183.	Vector Compare Equal or Zero Index	600	234.	Vector Load to Block Boundary . . . . .	634
184.	Vector Compare Equal or Zero Index with Condition Code. . . . .	601	235.	Vector Load with Length. . . . .	635
185.	Vector Compare Greater Than or Equal	602	236.	Vector Load Pair . . . . .	635
186.	Vector Compare Greater Than . . . . .	602	237.	Vector Store 2 float. . . . .	635
187.	Vector Compare Less Than or Equal . . . . .	603	238.	Vector Store with Length. . . . .	636
188.	Vector Compare Less Than . . . . .	603	239.	Vector Load 2 Doubleword . . . . .	636
189.	Vector Compare Not Equal Index . . . . .	603	240.	Vector Load 4 Word . . . . .	636
190.	Vector Compare Not Equal Index with Condition Code. . . . .	604	241.	Vector Store 2 Doubleword . . . . .	637
191.	Vector Compare Not Equal or Zero Index	605	242.	Vector Store 4 Word . . . . .	637
192.	Vector Compare Not Equal or Zero Index with Condition Code . . . . .	605	243.	Vector Count Leading Zeros . . . . .	638
193.	Vector Compare Not in Ranges . . . . .	606	244.	Vector Count Trailing Zeros. . . . .	638
194.	Vector Compare Not in Ranges with Condition Code. . . . .	608	245.	Vector NOR . . . . .	638
195.	Vector Compare Not in Ranges Index	608	246.	Vector Population Count. . . . .	639
196.	Vector Compare Not in Ranges Index with Condition Code. . . . .	609	247.	Vector Merge High. . . . .	640
197.	Vector Compare Not in Ranges or Zero Index	610	248.	Vector Merge Low . . . . .	641
198.	Vector Compare Not in Ranges or Zero Index with Condition Code . . . . .	611	249.	Vector Pack . . . . .	642
199.	Vector Compare Ranges . . . . .	612	250.	Vector Pack Saturate . . . . .	643
200.	Vector Compare Ranges with Condition Code	613	251.	Vector Pack Saturate Condition Code	643
201.	Vector Compare Ranges Index . . . . .	614	252.	Vector Pack Saturated Unsigned . . . . .	643
202.	Vector Compare Ranges Index with Condition Code . . . . .	615	253.	Vector Pack Saturated Unsigned Condition Code . . . . .	644
			254.	Vector Unpack High Element . . . . .	644

255.	Vector Unpack Low Element . . . . .	645	316.	Symbols not supported . . . . .	685
256.	Vector Splat . . . . .	645	317.	Examples of acceptable alias types . . . . .	698
257.	Vector Splat Signed Byte . . . . .	646	318.	Comparison of code generated with the ANSIALIAS and NOANSIALIAS options . . . . .	699
258.	Vector Splat Signed Halfword . . . . .	646	319.	Example of using temporaries to remove aliasing effects . . . . .	701
259.	Vector Splat Signed Word . . . . .	646	320.	Referencing data types . . . . .	706
260.	Vector Splat Signed Doubleword . . . . .	646	321.	Pragmas that affect performance . . . . .	708
261.	Vector Splat Unsigned Byte . . . . .	647	322.	SMP suboptions. . . . .	713
262.	Vector Splat Unsigned Halfword . . . . .	647	323.	C-library built-in functions . . . . .	715
263.	Vector Splat Unsigned Word . . . . .	647	324.	Platform-specific built-in functions . . . . .	716
264.	Vector Splat Doubleword . . . . .	647	325.	Examples of optimization . . . . .	729
265.	Vector Splats . . . . .	647	326.	Header files and library names for the MASS scalar library. . . . .	741
266.	Vector Element Rotate Left . . . . .	648	327.	MASS scalar functions . . . . .	742
267.	Vector Element Rotate and Insert Under Mask	649	328.	Header files and library names for the MASS vector library . . . . .	744
268.	Vector Element Rotate Left Immediate	649	329.	MASS floating-point vector functions	745
269.	Vector Shift Left by Byte . . . . .	649	330.	MASS integer vector functions . . . . .	747
270.	Vector Shift Left Double by Byte . . . . .	651	331.	Header files and library names for the MASS SIMD library. . . . .	748
271.	Vector Shift Left Double by Word . . . . .	651	332.	MASS SIMD functions . . . . .	748
272.	Vector Shift Left. . . . .	652	333.	Sample interface routine provided: ATL_dgemm. . . . .	754
273.	Vector Shift Right Arithmetic by Byte	653	334.	Sample interface routine provided: cblas_dgemm . . . . .	754
274.	Vector Shift Right Arithmetic . . . . .	653	335.	Sample interface routine provided: clapack_dgesv . . . . .	754
275.	Vector Shift Right by Byte . . . . .	655	336.	Sample interface routine provided: dgemm_	755
276.	Vector Shift Right . . . . .	655	337.	Parts used for freestanding applications	798
277.	Vector Ceiling . . . . .	657	338.	Parts used by exit routines . . . . .	802
278.	Vector Convert to Double . . . . .	657	339.	Parts used by persistent environments	807
279.	Vector Convert to signed long long . . . . .	657	340.	Parts used by or with application server routines . . . . .	823
280.	Vector Convert to unsigned long long	657	341.	Abend and reason codes specific to system programming environments. . . . .	827
281.	Extend Sign to Doubleword. . . . .	657	342.	Summary of types . . . . .	828
282.	Vector Floor . . . . .	658	343.	User exits supported under z/OS Language Environment. . . . .	838
283.	Vector Round to Nearest. . . . .	658	344.	Sample Assembler user exits for z/OS Language Environment . . . . .	840
284.	Vector Round to Current. . . . .	658	345.	Interaction of Assembler user exits . . . . .	851
285.	Vector Round toward Negative Infinity	658	346.	Common data types between z/OS XL C and CSP. . . . .	905
286.	Vector Round toward Positive Infinity	659	347.	PCB generated for C program under TSO and IMS. . . . .	937
287.	Vector Round toward Zero . . . . .	659	348.	PCB generated for C or C++ program under TSO and IMS . . . . .	937
288.	Vector Truncate . . . . .	659	349.	Characters in portable character set and corresponding symbolic names. . . . .	956
289.	Vector Floating-Point Test Data Class	660	350.	Locale object prefix . . . . .	995
290.	Vector Test under Mask . . . . .	660	351.	Supported language-territory names and LT codes for EBCDIC locales . . . . .	996
291.	All Elements Equal . . . . .	661	352.	Supported language-territory names and LT codes for ASCII locales . . . . .	998
292.	All Elements Greater Than or Equal . . . . .	662	353.	Supported codeset names and CC codes	1001
293.	All Elements Greater Than . . . . .	663	354.	C macros used as synonyms for special locale names . . . . .	1004
294.	All Elements Less Than or Equal . . . . .	664	355.	Referencing data types . . . . .	1026
295.	All Elements Less Than . . . . .	665	356.	Coded character set conversion tables	1027
296.	All Elements Not a Number . . . . .	665	357.	UCS-2 converter names . . . . .	1037
297.	All Elements Not Equal . . . . .	666			
298.	All Elements Not Greater Than or Equal	667			
299.	All Elements Not Greater Than . . . . .	667			
300.	All Elements Not Less Than or Equal	667			
301.	All Elements Not Less Than . . . . .	667			
302.	All Elements Numeric . . . . .	667			
303.	Any Element Equal . . . . .	668			
304.	Any Element Greater Than or Equal . . . . .	669			
305.	Any Element Greater Than . . . . .	670			
306.	Any Element Less Than or Equal . . . . .	671			
307.	Any Element Less Than . . . . .	672			
308.	Any Element Not a Number . . . . .	672			
309.	Any Element Not Equal . . . . .	673			
310.	Any Element Not Greater Than or Equal	673			
311.	Any Element Not Greater Than . . . . .	674			
312.	Any Element Not Less Than or Equal	674			
313.	Any Element Not Less Than . . . . .	674			
314.	Any Element Numeric . . . . .	674			
315.	SUSv3 options and option groups. . . . .	683			

358. Mappings of 13 PPCS variant characters	1048	364. ASCII locale object names and method files in the z/OS UNIX file system. . . . .	1107
359. Mappings of Hex encoding of 13 PPCS variant characters. . . . .	1048	365. Locale source files supplied with z/OS XL C/C++ . . . . .	1112
360. Layout attribute and values . . . . .	1067	366. Coded character set names and corresponding primary country/territory . . . . .	1117
361. Referencing data types . . . . .	1091		
362. Compiled EBCDIC locales supplied with z/OS XL C/C++ . . . . .	1092		
363. Compiled ASCII locales supplied with z/OS XL C/C++ . . . . .	1101		



---

## About this document

This document provides information about implementing programs that are written in C and C++. It contains advanced guidelines and information for developing C and C++ programs to run under z/OS®.

This document contains terminology, maintenance, and editorial changes. Technical changes or additions to the text and illustrations are indicated by a vertical line (|) to the left of the change.

You may notice changes in the style and structure of some of the contents in this document; for example, headings that use uppercase for the first letter of initial words only, and procedures that have a different look and format. The changes are ongoing improvements to the consistency and retrievability of information in our documents.

### How to read syntax diagrams

This section describes how to read syntax diagrams. It defines syntax diagram symbols, items that may be contained within the diagrams (keywords, variables, delimiters, operators, fragment references, operands) and provides syntax examples that contain these items.

Syntax diagrams pictorially display the order and parts (options and arguments) that comprise a command statement. They are read from left to right and from top to bottom, following the main path of the horizontal line.

For users accessing the Information Center using a screen reader, syntax diagrams are provided in dotted decimal format.

The following symbols may be displayed in syntax diagrams:

#### Symbol

##### Definition

- ▶— Indicates the beginning of the syntax diagram.
- ▶ Indicates that the syntax diagram is continued to the next line.
- ▶— Indicates that the syntax is continued from the previous line.
- ▶ Indicates the end of the syntax diagram.

Syntax diagrams contain many different items. Syntax items include:

- Keywords - a command name or any other literal information.
- Variables - variables are italicized, appear in lowercase, and represent the name of values you can supply.
- Delimiters - delimiters indicate the start or end of keywords, variables, or operators. For example, a left parenthesis is a delimiter.
- Operators - operators include add (+), subtract (-), multiply (\*), divide (/), equal (=), and other mathematical operations that may need to be performed.
- Fragment references - a part of a syntax diagram, separated from the diagram to show greater detail.

- Separators - a separator separates keywords, variables or operators. For example, a comma (,) is a separator.

**Note:** If a syntax diagram shows a character that is not alphanumeric (for example, parentheses, periods, commas, equal signs, a blank space), enter the character as part of the syntax.

Keywords, variables, and operators may be displayed as required, optional, or default. Fragments, separators, and delimiters may be displayed as required or optional.

**Item type**

**Definition**

**Required**

Required items are displayed on the main path of the horizontal line.

**Optional**

Optional items are displayed below the main path of the horizontal line.

**Default**

Default items are displayed above the main path of the horizontal line.



The following table provides syntax examples.

*Table 1. Syntax examples*

Item	Syntax example
Required item.	
Required items appear on the main path of the horizontal line. You must specify these items.	
Required choice.	
A required choice (two or more items) appears in a vertical stack on the main path of the horizontal line. You must choose one of the items in the stack.	
Optional item.	
Optional items appear below the main path of the horizontal line.	
Optional choice.	
An optional choice (two or more items) appears in a vertical stack below the main path of the horizontal line. You may choose one of the items in the stack.	
Default.	
Default items appear above the main path of the horizontal line. The remaining items (required or optional) appear on (required) or below (optional) the main path of the horizontal line. The following example displays a default with optional items.	

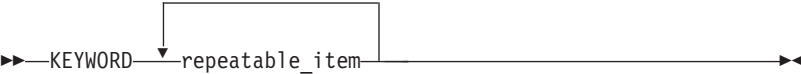

Table 1. Syntax examples (continued)

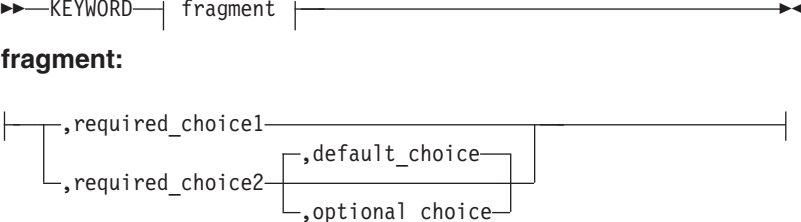
Item	Syntax example
<p>Variable.</p> <p>Variables appear in lowercase italics. They represent names or values.</p>	
<p>Repeatable item.</p> <p>An arrow returning to the left above the main path of the horizontal line indicates an item that can be repeated.</p>	
<p>A character within the arrow means you must separate repeated items with that character.</p>	
<p>An arrow returning to the left above a group of repeatable items indicates that one of the items can be selected, or a single item can be repeated.</p>	
<p>Fragment.</p> <p>The fragment symbol indicates that a labelled group is described below the main syntax diagram. Syntax is occasionally broken into fragments if the inclusion of the fragment would overly complicate the main syntax diagram.</p>	

## z/OS XL C/C++ and related documents

This topic summarizes the content of the z/OS XL C/C++ documents and shows where to find related information in other documents.

Table 2. z/OS XL C/C++ and related documents

Document Title and Number	Key Sections/Chapters in the Document
z/OS XL C/C++ Programming Guide, SC14-7315	<p>Guidance information for:</p> <ul style="list-style-type: none"> <li>• XL C/C++ input and output</li> <li>• Debugging z/OS XL C programs that use input/output</li> <li>• Using linkage specifications in C++</li> <li>• Combining C and assembler</li> <li>• Creating and using DLLs</li> <li>• Using threads in z/OS UNIX System Services applications</li> <li>• Reentrancy</li> <li>• Handling exceptions, error conditions, and signals</li> <li>• Performance optimization</li> <li>• Network communications under z/OS UNIX</li> <li>• Interprocess communications using z/OS UNIX</li> <li>• Structuring a program that uses C++ templates</li> <li>• Using environment variables</li> <li>• Using System Programming C facilities</li> <li>• Library functions for the System Programming C facilities</li> <li>• Using runtime user exits</li> <li>• Using the z/OS XL C multitasking facility</li> <li>• Using other IBM® products with z/OS XL C/C++ (IBM CICS® Transaction Server for z/OS, CSP, DWS, IBM DB2®, IBM GDDM, IBM IMS™, ISPF, IBM QMF™)</li> <li>• Globalization: locales and character sets, code set conversion utilities, mapping variant characters</li> <li>• POSIX character set</li> <li>• Code point mappings</li> <li>• Locales supplied with z/OS XL C/C++</li> <li>• Charmap files supplied with z/OS XL C/C++</li> <li>• Examples of charmap and locale definition source files</li> <li>• Converting code from coded character set IBM-1047</li> <li>• Using built-in functions</li> <li>• Using vector programming support</li> <li>• Using runtime check library</li> <li>• Using high performance libraries</li> <li>• Programming considerations for z/OS UNIX C/C++</li> </ul>
z/OS XL C/C++ User's Guide, SC14-7307	<p>Guidance information for:</p> <ul style="list-style-type: none"> <li>• z/OS XL C/C++ examples</li> <li>• Compiler options</li> <li>• Binder options and control statements</li> <li>• Specifying Language Environment® runtime options</li> <li>• Compiling, IPA Linking, binding, and running z/OS XL C/C++ programs</li> <li>• Utilities (Object Library, CXXFILT, DSECT Conversion, Code Set and Locale, ar and make, BPXBATCH, c89, xlc)</li> <li>• Diagnosing problems</li> <li>• Cataloged procedures and IBM REXX EXECs</li> <li>• Customizing default options for the z/OS XL C/C++ compiler</li> </ul>

Table 2. z/OS XL C/C++ and related documents (continued)

Document Title and Number	Key Sections/Chapters in the Document
<i>z/OS XL C/C++ Language Reference, SC14-7308</i>	Reference information for: <ul style="list-style-type: none"> <li>• The C and C++ languages</li> <li>• Lexical elements of z/OS XL C and C++</li> <li>• Declarations, expressions, and operators</li> <li>• Implicit type conversions</li> <li>• Functions and statements</li> <li>• Preprocessor directives</li> <li>• C++ classes, class members, and friends</li> <li>• C++ overloading, special member functions, and inheritance</li> <li>• C++ templates and exception handling</li> <li>• z/OS XL C and C++ compatibility</li> </ul>
<i>z/OS XL C/C++ Messages, GC14-7305</i>	Provides error messages and return codes for the compiler, and its related application interface libraries and utilities. For the XL C/C++ runtime library messages, refer to <i>z/OS Language Environment Runtime Messages, SA38-0686</i> . For the c89 and xlc utility messages, refer to <i>z/OS UNIX System Services Messages and Codes, SA23-2284</i> .
<i>z/OS XL C/C++ Runtime Library Reference, SC14-7314</i>	Reference information for: <ul style="list-style-type: none"> <li>• header files</li> <li>• library functions</li> </ul>
<i>z/OS C Curses, SA38-0690</i>	Reference information for: <ul style="list-style-type: none"> <li>• Curses concepts</li> <li>• Key data types</li> <li>• General rules for characters, renditions, and window properties</li> <li>• General rules of operations and operating modes</li> <li>• Use of macros</li> <li>• Restrictions on block-mode terminals</li> <li>• Curses functional interface</li> <li>• Contents of headers</li> <li>• The terminfo database</li> </ul>
<i>z/OS XL C/C++ Compiler and Runtime Migration Guide for the Application Programmer, GC14-7306</i>	Guidance and reference information for: <ul style="list-style-type: none"> <li>• Common migration questions</li> <li>• Application executable program compatibility</li> <li>• Source program compatibility</li> <li>• Input and output operations compatibility</li> <li>• Class library migration considerations</li> <li>• Changes between releases of z/OS</li> <li>• Pre-z/OS C and C++ compilers to current compiler migration</li> <li>• Other migration considerations</li> </ul>
<i>z/OS Metal C Programming Guide and Reference, SC14-7313</i>	Guidance and reference information for: <ul style="list-style-type: none"> <li>• Metal C run time</li> <li>• Metal C programming</li> <li>• AR mode</li> </ul>

Table 2. z/OS XL C/C++ and related documents (continued)

Document Title and Number	Key Sections/Chapters in the Document
<i>Standard C++ Library Reference, SC14-7309</i>	<p>The documentation describes how to use the following three main components of the Standard C++ Library to write portable C/C++ code that complies with the ISO standards:</p> <ul style="list-style-type: none"> <li>• ISO Standard C Library</li> <li>• ISO Standard C++ Library</li> <li>• Standard Template Library (C++)</li> </ul> <p>The ISO Standard C++ library consists of 51 required headers. These 51 C++ library headers (along with the additional 18 Standard C headers) constitute a hosted implementation of the C++ library. Of these 51 headers, 13 constitute the Standard Template Library, or STL.</p>
<i>z/OS Common Debug Architecture User's Guide, SC14-7310</i>	<p>This documentation is the user's guide for IBM's libddpi library. It includes:</p> <ul style="list-style-type: none"> <li>• Overview of the architecture</li> <li>• Information on the order and purpose of API calls for model user applications and for accessing DWARF information</li> <li>• Information on using the Common Debug Architecture with C/C++ source</li> </ul> <p>This user's guide is part of the Runtime Library Extensions documentation.</p>
<i>z/OS Common Debug Architecture Library Reference, SC14-7311</i>	<p>This documentation is the reference for IBM's libddpi library. It includes:</p> <ul style="list-style-type: none"> <li>• General discussion of Common Debug Architecture</li> <li>• Description of APIs and data types related to stacks, processes, operating systems, machine state, storage, and formatting</li> </ul> <p>This reference is part of the Runtime Library Extensions documentation.</p>
<i>DWARF/ELF Extensions Library Reference, SC14-7312</i>	<p>This documentation is the reference for IBM's extensions to the libdwarf and libelf libraries. It includes information on:</p> <ul style="list-style-type: none"> <li>• Consumer APIs</li> <li>• Producer APIs</li> </ul> <p>This reference is part of the Runtime Library Extensions documentation.</p>
Debug Tool documentation, available on the Debug Tool for z/OS library page on the World Wide Web	<p>The documentation, which is available at <a href="http://www.ibm.com/software/awdtools/debugtool/library/">http://www.ibm.com/software/awdtools/debugtool/library/</a>, provides guidance and reference information for debugging programs, using Debug Tool in different environments, and language-specific information.</p>
README file	<p>The README file provides additional information for using the z/OS XL C/C++ licensed program, including late changes to z/OS XL C/C++ publications. To access any README files that were published after the ship date, go to <a href="http://www.ibm.com/support/docview.wss?uid=swg27007531">http://www.ibm.com/support/docview.wss?uid=swg27007531</a>.</p>

**Note:** For complete and detailed information on linking and running with Language Environment services and using the Language Environment runtime options, refer to *z/OS Language Environment Programming Guide, SA38-0682*. For complete and detailed information on using interlanguage calls, refer to *z/OS V2R1.0 Language Environment Writing Interlanguage Communication Applications, SA38-0684*.

The following table lists the z/OS XL C/C++ and related documents. The table groups the documents according to the tasks they describe.

Table 3. Documents by task

Tasks	Documents
Planning, preparing, and migrating to z/OS XL C/C++	<ul style="list-style-type: none"> <li>• <i>z/OS XL C/C++ Compiler and Runtime Migration Guide for the Application Programmer</i>, GC14-7306</li> <li>• <i>z/OS Language Environment Customization</i>, SA38-0685</li> <li>• <i>z/OS V2R1.0 Language Environment Runtime Application Migration Guide</i>, GA32-0912</li> <li>• <i>z/OS UNIX System Services Planning</i>, GA32-0884</li> <li>• <i>z/OS Planning for Installation</i>, GA32-0890</li> </ul>
Installing	<ul style="list-style-type: none"> <li>• <i>z/OS Program Directory</i></li> <li>• <i>z/OS Planning for Installation</i>, GA32-0890</li> <li>• <i>z/OS Language Environment Customization</i>, SA38-0685</li> </ul>
Option customization	<ul style="list-style-type: none"> <li>• <i>z/OS XL C/C++ User's Guide</i>, SC14-7307</li> </ul>
Coding programs	<ul style="list-style-type: none"> <li>• <i>z/OS XL C/C++ Runtime Library Reference</i>, SC14-7314</li> <li>• <i>z/OS XL C/C++ Language Reference</i>, SC14-7308</li> <li>• <i>z/OS XL C/C++ Programming Guide</i>, SC14-7315</li> <li>• <i>z/OS Metal C Programming Guide and Reference</i>, SC14-7313</li> <li>• <i>z/OS V2R1.0 Language Environment Concepts Guide</i>, SA38-0687</li> <li>• <i>z/OS Language Environment Programming Guide</i>, SA38-0682</li> <li>• <i>z/OS Language Environment Programming Reference</i>, SA38-0683</li> </ul>
Coding and binding programs with interlanguage calls	<ul style="list-style-type: none"> <li>• <i>z/OS XL C/C++ Programming Guide</i>, SC14-7315</li> <li>• <i>z/OS XL C/C++ Language Reference</i>, SC14-7308</li> <li>• <i>z/OS Language Environment Programming Guide</i>, SA38-0682</li> <li>• <i>z/OS V2R1.0 Language Environment Writing Interlanguage Communication Applications</i>, SA38-0684</li> <li>• <i>z/OS MVS Program Management: User's Guide and Reference</i>, SA23-1393</li> <li>• <i>z/OS MVS Program Management: Advanced Facilities</i>, SA23-1392</li> </ul>
Compiling, binding, and running programs	<ul style="list-style-type: none"> <li>• <i>z/OS XL C/C++ User's Guide</i>, SC14-7307</li> <li>• <i>z/OS Language Environment Programming Guide</i>, SA38-0682</li> <li>• <i>z/OS Language Environment Debugging Guide</i>, GA32-0908</li> <li>• <i>z/OS MVS Program Management: User's Guide and Reference</i>, SA23-1393</li> <li>• <i>z/OS MVS Program Management: Advanced Facilities</i>, SA23-1392</li> </ul>
Compiling and binding applications in the z/OS UNIX (z/OS UNIX) environment	<ul style="list-style-type: none"> <li>• <i>z/OS XL C/C++ User's Guide</i>, SC14-7307</li> <li>• <i>z/OS V2R2.0 UNIX System Services User's Guide</i>, SA23-2279</li> <li>• <i>z/OS UNIX System Services Command Reference</i>, SA23-2280</li> <li>• <i>z/OS MVS Program Management: User's Guide and Reference</i>, SA23-1393</li> <li>• <i>z/OS MVS Program Management: Advanced Facilities</i>, SA23-1392</li> </ul>

Table 3. Documents by task (continued)

Tasks	Documents
Debugging programs	<ul style="list-style-type: none"> <li>• README file</li> <li>• <i>z/OS XL C/C++ User's Guide</i>, SC14-7307</li> <li>• <i>z/OS XL C/C++ Messages</i>, GC14-7305</li> <li>• <i>z/OS XL C/C++ Programming Guide</i>, SC14-7315</li> <li>• <i>z/OS Language Environment Programming Guide</i>, SA38-0682</li> <li>• <i>z/OS Language Environment Debugging Guide</i>, GA32-0908</li> <li>• <i>z/OS Language Environment Runtime Messages</i>, SA38-0686</li> <li>• <i>z/OS UNIX System Services Messages and Codes</i>, SA23-2284</li> <li>• <i>z/OS V2R2.0 UNIX System Services User's Guide</i>, SA23-2279</li> <li>• <i>z/OS UNIX System Services Command Reference</i>, SA23-2280</li> <li>• <i>z/OS UNIX System Services Programming Tools</i>, SA23-2282</li> <li>• Debug Tool documentation, available on the Debug Tool Library page on the World Wide Web (<a href="http://www.ibm.com/software/awdtools/debugtool/library/">http://www.ibm.com/software/awdtools/debugtool/library/</a>)</li> </ul>
Developing debuggers and profilers	<ul style="list-style-type: none"> <li>• <i>z/OS Common Debug Architecture User's Guide</i>, SC14-7310</li> <li>• <i>z/OS Common Debug Architecture Library Reference</i>, SC14-7311</li> <li>• <i>DWARF/ELF Extensions Library Reference</i>, SC14-7312</li> </ul>
Packaging XL C/C++ applications	<ul style="list-style-type: none"> <li>• <i>z/OS XL C/C++ Programming Guide</i>, SC14-7315</li> <li>• <i>z/OS XL C/C++ User's Guide</i>, SC14-7307</li> </ul>
Using shells and utilities in the z/OS UNIX environment	<ul style="list-style-type: none"> <li>• <i>z/OS XL C/C++ User's Guide</i>, SC14-7307</li> <li>• <i>z/OS UNIX System Services Command Reference</i>, SA23-2280</li> <li>• <i>z/OS UNIX System Services Messages and Codes</i>, SA23-2284</li> </ul>
Using sockets library functions in the z/OS UNIX environment	<ul style="list-style-type: none"> <li>• <i>z/OS XL C/C++ Runtime Library Reference</i>, SC14-7314</li> </ul>
Using the ISO Standard C++ Library to write portable C/C++ code that complies with ISO standards	<ul style="list-style-type: none"> <li>• <i>Standard C++ Library Reference</i>, SC14-7309</li> </ul>
Performing diagnosis and submitting an Authorized Program Analysis Report (APAR)	<ul style="list-style-type: none"> <li>• <i>z/OS XL C/C++ User's Guide</i>, SC14-7307</li> </ul>

**Note:** For information on using the prelinker, see the appendix on prelinking and linking z/OS XL C/C++ programs in *z/OS XL C/C++ User's Guide*.

## Softcopy documents

The z/OS XL C/C++ publications are supplied in PDF format and available for download at <http://www.ibm.com/software/awdtools/czos/library/>.

To read a PDF file, use the Adobe Reader. If you do not have the Adobe Reader, you can download it (subject to Adobe license terms) from the Adobe website at <http://www.adobe.com>.

You can also browse the documents on the World Wide Web by visiting the z/OS library at <http://www.ibm.com/systems/z/os/zos/bkserv/>.

**Note:** For further information on viewing and printing softcopy documents and using IBM BookManager®, see *z/OS V2R2 Information Roadmap*.



## Softcopy examples

Most of the larger examples in the following documents are available in machine-readable form:

- *z/OS XL C/C++ Language Reference, SC14-7308*
- *z/OS XL C/C++ User's Guide, SC14-7307*
- *z/OS XL C/C++ Programming Guide, SC14-7315*

In the following documents, a label on an example indicates that the example is distributed as a softcopy file:

- *z/OS XL C/C++ Language Reference, SC14-7308*
- *z/OS XL C/C++ Programming Guide, SC14-7315*
- *z/OS XL C/C++ User's Guide, SC14-7307*

The label is the name of a member in the CBC.SCCNSAM data set. The labels begin with the form CCN or CLB. Examples labelled as CLB appear only in the *z/OS XL C/C++ User's Guide*, while examples labelled as CCN appear in all three documents, and are further distinguished by *x* following CCN, where *x* represents one of the following:

- R and X refer to *z/OS XL C/C++ Language Reference, SC14-7308*
- G refers to *z/OS XL C/C++ Programming Guide, SC14-7315*
- U refers to *z/OS XL C/C++ User's Guide, SC14-7307*

---

## Related z/OS XL C/C++ information

The following list shows where to find related z/OS XL C/C++ information:

- Softcopy examples and related documents information in *z/OS XL C/C++ User's Guide*
- z/OS XL C/C++ home page at: [www.ibm.com/software/awdtools/czos/](http://www.ibm.com/software/awdtools/czos/)
- z/OS XL C/C++ documents in PDF and HTML formats at: [www.ibm.com/software/awdtools/czos/library/](http://www.ibm.com/software/awdtools/czos/library/)

---

## Where to find more information

For an overview of the information associated with z/OS, see *z/OS V2R2 Information Roadmap*.

### Information updates on the web

For the latest information updates that have been provided in PTF cover letters and documentation APARs for z/OS, see the online document z/OS APAR book ([http://publibz.boulder.ibm.com/cgi-bin/bookmgr\\_OS390/Shelves/ZDOCAPAR](http://publibz.boulder.ibm.com/cgi-bin/bookmgr_OS390/Shelves/ZDOCAPAR)) *z/OS V2R2 Information Roadmap*

This document is updated weekly and lists documentation changes before they are incorporated into z/OS publications.

### The z/OS Basic Skills Information Center

The z/OS Basic Skills Information Center is a Web-based information resource intended to help users learn the basic concepts of z/OS, the operating system that runs most of the IBM mainframe computers in use today. The Information Center

is designed to introduce a new generation of Information Technology professionals to basic concepts and help them prepare for a career as a z/OS professional, such as a z/OS system programmer.

Specifically, the z/OS Basic Skills Information Center is intended to achieve the following objectives:

- Provide basic education and information about z/OS without charge
- Shorten the time it takes for people to become productive on the mainframe
- Make it easier for new people to learn z/OS.

To access the z/OS Basic Skills Information Center, open your Web browser to the following Web site, which is available to all users (no login required): z/OS Basic Skills in IBM Knowledge Center ([www.ibm.com/support/knowledgecenter/zosbasics/com.ibm.zos.zbasics/homepage.html](http://www.ibm.com/support/knowledgecenter/zosbasics/com.ibm.zos.zbasics/homepage.html))

---

## How to send your comments to IBM

We appreciate your input on this documentation. Please provide us with any feedback that you have, including comments on the clarity, accuracy, or completeness of the information.

Use one of the following methods to send your comments:

**Important:** If your comment regards a technical problem, see instead “If you have a technical problem.”

- Send an email to [mhvrcfs@us.ibm.com](mailto:mhvrcfs@us.ibm.com).
- Send an email from the Contact z/OS web page ([www.ibm.com/systems/z/os/zos/webqs.html](http://www.ibm.com/systems/z/os/zos/webqs.html)).

Include the following information:

- Your name and address
- Your email address
- Your phone or fax number
- The publication title and order number:
  - z/OS V2R2 XL C/C++ Programming Guide
  - SC14-7315-08
- The topic and page number or URL of the specific information to which your comment relates
- The text of your comment.

When you send comments to IBM, you grant IBM a nonexclusive right to use or distribute the comments in any way appropriate without incurring any obligation to you.

IBM or any other organizations use the personal information that you supply to contact you only about the issues that you submit.

## If you have a technical problem

Do not use the feedback methods that are listed for sending comments. Instead, take one or more of the following actions:

- Visit the IBM Support Portal ([support.ibm.com](http://support.ibm.com)).
- Contact your IBM service representative.
- Call IBM technical support.

---

## What's new for z/OS V2R2 XL C/C++

The IBM z/OS XL C/C++ compiler delivers the following performance and usability enhancements for the z/OS V2R2 release:

### Changes to default ARCH and TUNE level

Starting with z/OS V2R2, the default ARCH level is changed from ARCH(7) to ARCH(8), and the default TUNE level is changed from TUNE(7) to TUNE(8).

### New compiler options and suboptions

- CHECKNEW
- DSAUSER(*value*)
- LANGLVL(NULLPTR) for C++ only
- TARGET(zOSV2R2)
- VECTOR(TYPE | AUTOSIMD)

### The `nullptr` keyword

This feature introduces `nullptr` as a null pointer constant for C++. The `nullptr` constant can be distinguished from integer 0 for overloaded functions. The constants of 0 and `NULL` are treated as of the integer type for overloaded functions, whereas `nullptr` can be implicitly converted to only the pointer type, pointer-to-member type, and `bool` type. You can use the `LANGLVL(NULLPTR)` option to enable this feature.



---

## Part 1. Introduction

This part discusses introductory concepts on the z/OS XL C/C++ feature. Specifically, it discusses the following:

- Chapter 1, “About IBM z/OS XL C/C++,” on page 3



---

## Chapter 1. About IBM z/OS XL C/C++

For an introduction to z/OS XL C/C++ and for information about changes to z/OS XL C/C++ for the current release, see About IBM z/OS XL C/C++ in *z/OS XL C/C++ User's Guide*.





---

## Part 2. Input and Output

This part describes the models of input and output available with IBM z/OS XL C/C++.

The C runtime functions are available if the corresponding C header files are used. C I/O can be used by C++ when the C runtime library functions are used.

The following references provide a description and examples of I/O streams:

- Chapter 2, "Introduction to C and C++ input and output," on page 7
- Chapter 3, "Understanding models of C I/O," on page 11
- Chapter 4, "Using the Standard C++ Library I/O Stream Classes," on page 23
- Chapter 5, "Opening files," on page 27
- Chapter 6, "Buffering of C streams," on page 45
- Chapter 7, "Using ASA text files," on page 47
- Chapter 8, "z/OS XL C Support for the double-byte character set," on page 53
- Chapter 9, "Using C and C++ standard streams and redirection," on page 63
- Chapter 10, "Performing OS I/O operations," on page 83
- Chapter 11, "Performing z/OS UNIX file system I/O operations," on page 127
- Chapter 12, "Performing VSAM I/O operations," on page 151
- Chapter 13, "Performing terminal I/O operations," on page 191
- Chapter 14, "Performing memory file and hiperspace I/O operations," on page 201
- Chapter 15, "Performing CICS Transaction Server I/O operations," on page 215
- Chapter 16, "Language Environment Message file operations," on page 217
- Chapter 17, "CELQPIPI MSGRTN file operations," on page 219
- Chapter 18, "Debugging I/O programs," on page 223



---

## Chapter 2. Introduction to C and C++ input and output

This chapter provides you with a general introduction to C and C++ input and output (I/O). Four types of C and C++ input and output are discussed in this chapter:

- text streams
- binary streams
- record I/O
- blocked I/O

---

### Types of C and C++ input and output

A stream is a flow of data elements that are transmitted or intended for transmission in a defined format. A record is a set of data elements treated as a unit, and a file (or data set) is a named set of records that is stored or processed as a unit.

The z/OS XL C/C++ compiler supports four types of input and output: text streams, binary streams, record I/O, and blocked I/O. Text and binary streams are both ANSI standards; record I/O and blocked I/O are extensions for z/OS XL C. Record I/O and blocked I/O are not supported by either the USL I/O Stream Class Library or the Standard C++ I/O stream classes.

**Note:** If you have written data in one of these four types and try to read it as another type (for example, reading a binary file in text mode), you may not get the behavior that you expect.

#### Text streams

Text streams contain printable characters and, depending on the type of file, control characters. Text streams are organized into lines. Each line ends with a control character, usually a new-line. The last record in a text file may or may not end with a control character, depending on what kind of file you are using. Text files recognize the following control characters:

- `\a` Alarm.
- `\b` Backspace.
- `\f` Form feed.
- `\n` New-line.
- `\r` Carriage return.
- `\t` Horizontal tab character.
- `\v` Vertical tab character.
- `\x0E` DBCS shift-out character. Indicates the beginning of a DBCS string, if `MB_CUR_MAX>1` in the definition of the locale that is in effect. For more information about `__MBCURMAX`, see Chapter 8, “z/OS XL C Support for the double-byte character set,” on page 53.
- `\x0F` DBCS shift-in character. Indicates the end of a DBCS string, if `MB_CUR_MAX>1`

in the definition of the locale that is in effect. For more information about `__MBCURMAX`, see Chapter 8, “z/OS XL C Support for the double-byte character set,” on page 53.

Control characters behave differently in terminal files (see Chapter 13, “Performing terminal I/O operations,” on page 191) and ASA files (see Chapter 7, “Using ASA text files,” on page 47).

## Binary streams

Binary streams contain a sequence of bytes. For binary streams, the library does not translate any characters on input or output. It treats them as a continuous stream of bytes, and ignores any record boundaries. When data is written out to a record-oriented file, it fills one record before it starts filling the next. Streams in the z/OS UNIX file system follow the binary model, regardless of whether they are opened for text, binary, record I/O, or blocked I/O. You can simulate record I/O by using new-line characters as record boundaries.

## Record I/O

Record I/O is an extension to the ISO standard. For files opened in record format, z/OS XL C/C++ reads and writes one record at a time. If you try to write more data to a record than the record can hold, the data is truncated. For record I/O, z/OS XL C/C++ allows only the use of `fread()` and `fwrite()` to read and write to files. Any other functions (such as `fprintf()`, `fscanf()`, `getc()`, and `putc()`) will fail. For record-oriented files, records do not change size when you update them. If the new record has fewer bytes than the original record, the new data fills the first  $n$  bytes, where  $n$  is the number of bytes of the new data. The record will remain the same size, and the old bytes (those after  $n$ ) are left unchanged. A subsequent update begins at the next boundary. For example, if you have the string “abcdefgh”:

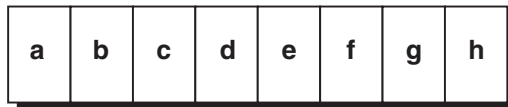

and you overwrite it with the string “1234”, the record will look like this:



z/OS XL C/C++ record I/O is binary. That is, it does not interpret any of the data in a record file and therefore does not recognize control characters. The only exception is for file categories that do not support records, such as the UNIX file system (also known as POSIX I/O). For these files, z/OS XL C/C++ uses new-line characters as record boundaries.

## Blocked I/O

Blocked I/O is an extension to the ISO standard. For files opened in block format, z/OS XL C/C++ reads and writes one block at a time. If you try to write more data to a block than the block can hold, the data is truncated. For blocked I/O, z/OS XL C/C++ allows only the use of `fread()` and `fwrite()` to read and write to files. Any other functions (such as `fprintf()`, `fscanf()`, `getc()`, and `putc()`) will

fail. Blocks do not change size when you update them. If the new block has fewer bytes than the original block, the new data fills the first  $n$  bytes, where  $n$  is the number of bytes of the new data. The block will remain the same size, and the old bytes (those after  $n$ ) are left unchanged. A subsequent update begins at the next boundary. For example, if you have the string "abcdefgh":

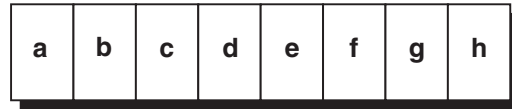

and you overwrite it with the string "1234", the block will look like this:



z/OS XL C/C++ blocked I/O is binary. That is, it does not interpret any of the data in a block file and therefore does not recognize control characters.

The `fflush()` function has no effect for blocked I/O files.





---

## Chapter 3. Understanding models of C I/O

This chapter describes z/OS XL C/C++ support for the major models of C I/O:

- The record model
- The byte stream model

The next chapter (Chapter 4, “Using the Standard C++ Library I/O Stream Classes,” on page 23) describes a third major model, the *object-oriented model*.

---

### The record model for C I/O

Almost all the kinds of I/O that z/OS XL C/C++ supports use this model. The only ones that do not are z/OS UNIX file system, memory file, and Hiperspace™ I/O.

The record model consists of the following:

- A *record*, which is the unit of data transmitted to and from a program.
- A *block*, which is the unit of data transmitted to and from a device. Each block may contain one or more records.

In the record model of I/O, records and blocks have the following attributes:

#### RECFM

Specifies the format of the data or how the data is organized on the physical device.

#### LRECL

Specifies the length of logical records (as opposed to physical ones). Variable length records include a count field that is normally not available to the programmer.

#### BLKSIZE

Specifies the length of physical records (blocks on the physical device).

### Record formats

Use the RECFM attribute to specify the record format. The records in a file using the record model have one of the following formats:

- Fixed-length (F)
- Variable-length (V)
- Undefined-length (U)

**Note:** z/OS XL C/C++ does not support Format-D files.

These formats support the following additional options for RECFM. The record formats and the options associated with them are discussed in the following sections.

- A** Specifies that the file contains ASA control characters.
- B** Specifies that a file is blocked. A blocked file can have more than one record in each block.
- M** Specifies that the file contains machine control characters.

- S** Specifies that a file is either in standard format (if it is fixed) or spanned (if it is variable). In a standard file, every block must be full before another one starts. In a spanned file, a record can be longer than a block. If it is, the record is divided into segments and stored in consecutive blocks.

Not all the I/O categories (listed in Table 6 on page 29) support all of these attributes. Depending on what category you are using, z/OS XL C/C++ ignores or simulates attributes that do not apply. For more information on the record formats and the options supported for each I/O category, see Chapter 5, “Opening files,” on page 27.

### Fixed-format records

These are the formats you can specify for RECFM if you want to use a fixed-format file:

- F** Fixed-length, unblocked
- FA** Fixed-length, ASA print-control characters
- FB** Fixed-length, blocked
- FM** Fixed-length, machine print-control codes
- FS** Fixed-length, unblocked, standard
- FBA** Fixed-length, blocked, ASA print-control characters
- FBM** Fixed-length, blocked, machine print-control codes
- FBS** Fixed-length, blocked, standard
- FSA** Fixed-length, unblocked, standard, ASA print-control characters
- FSM** Fixed-length, unblocked, standard, machine print-control codes
- FBSM** Fixed-length, blocked, standard, machine print-control codes
- FBSA** Fixed-length, blocked, standard, ASA print-control characters.

In general, all references to files with record format FB also refer to FBM and FBA. The specific behavior of ASA files (such as FBA) is explained in Chapter 7, “Using ASA text files,” on page 47.

**Attention:** z/OS XL C/C++ distinguishes between FB and FBS formats, because an FBS file contains no embedded short blocks (the last block may be short). FBS files give you much better performance. The use of standard (S) blocks optimizes the sequential processing of a file on a direct-access device. With a standard format file, the file pointer can be directly repositioned by calculating the exact position in that file of a given record rather than reading through the entire file.

If the records are FB, some blocks may contain fewer records than others, as shown in Figure 1 on page 13.

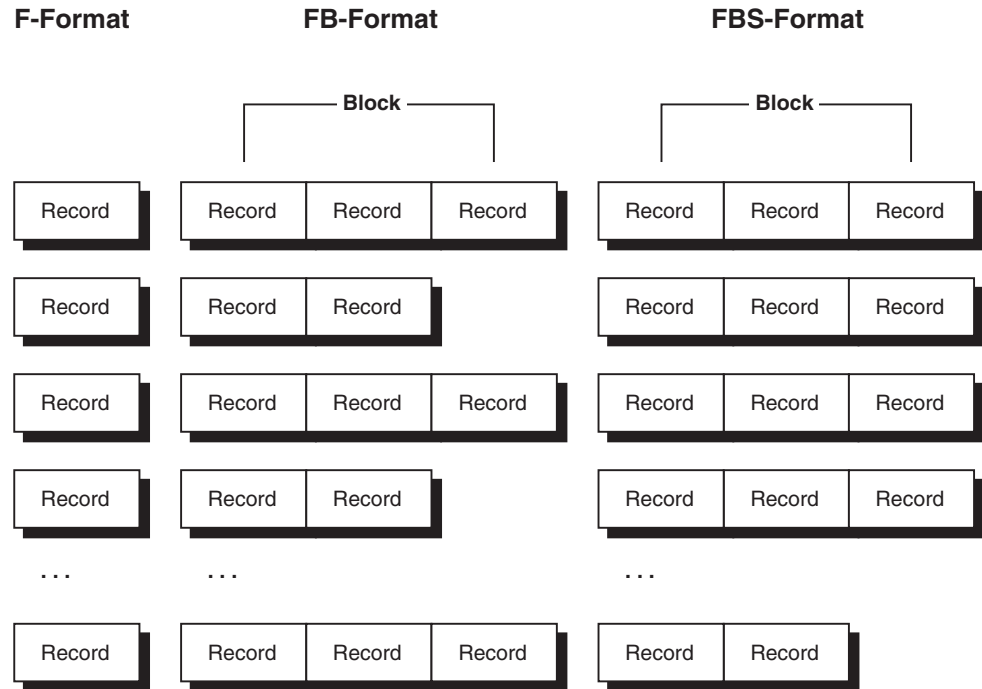

Figure 1. Blocking fixed-length records

**Mapping C types to fixed format:** This section describes the following formats:

- Binary
- Text (non-ASA)
- Text (ASA)
- Record
- Blocked

### Binary

On binary input and output, data flows over record boundaries. Because all fixed-format records must be full, z/OS XL C/C++ completes any incomplete output record by padding it with nulls ('\0') when you close the file. Incomplete *blocks* are not padded. On input, nulls are visible and are treated as data.

For example, if record length is set to 10 and you are writing 25 characters of data, z/OS XL C/C++ will write two full records, each containing 10 characters, and then an incomplete record containing 5 characters. If you then close the file, z/OS XL C/C++ will complete the last record with 5 nulls. If you open the file for reading, z/OS XL C/C++ will read the records in order. z/OS XL C/C++ will not strip off the nulls at the end of the last record.

### Text (non-ASA)

When writing in a text stream, you indicate the end of the data for a record by writing a new-line ('\n') or carriage return ('\r') to the stream. In a fixed-format file, the new-line or carriage return will not appear in the external file, and the record will be padded with blanks from the position of the new-line or carriage return to LRECL. (A carriage return is considered the same as a new-line because the '\r' is not written to the file.)

For example, if you have set LRECL to 10, and you write the string "ABC\n" to a fixed-format text file, z/OS XL C/C++ will write this to the physical

file:



A record containing only a new-line is written to the file as LRECL blanks.

When reading in a text stream, the I/O functions place a new-line character ('\n') in the buffer to indicate the end of data for the record. In a fixed-format file, the new-line character is placed at the start of the blank padding at the end of the data.

For example, if your file position points to the start of the following record in a fixed-format file opened as a text stream



and you call `fgets()` to read the line of text, `fgets()` places the string "ABC\n" in your input buffer.

**Attention:** Any blanks written immediately before a new-line or carriage return will be considered blank padding when the record is read back from the file. You cannot change the padding character.

When you are updating a fixed-format file opened as a text stream, you can update the amount of data in a record. The maximum length of the updated data is LRECL bytes plus the new-line character; the minimum length is zero data bytes plus the new-line character. Writing new data into an existing record replaces the old data. If the new data is longer or shorter than the old data, the number of blank padding characters in the record in the external file is changed. When you extend a record, thereby writing over the old new-line, there will be a new-line character implied after the new characters. For instance, if you were to overwrite the record mentioned in the previous example with the string "123456", the records in the physical file would then look like this:



The blanks at the end of the record imply a new-line at position 7. You can see this new-line by calling `fflush()` and then performing a read. The implied new-line is the first character returned from this read.

A fixed record can hold only LRECL characters. If you try to write more than that, z/OS XL C/C++ truncates the data unless you are using a standard stream or a terminal file. In this case, the output is split across multiple records. If truncation occurs, z/OS XL C/C++ raises SIGIOERR and sets both `errno` and the error flag.

## Text (ASA)

For ASA files, the first character of each record is reserved for the ASA control character that represents a new-line, a carriage return, or a form feed. This control character represents what should happen before the record is written.

Table 4. C control to ASA characters

C Control Character	ASA Character	Description
\n	' '	skip one line
\n\n	'0'	skip two lines
\n\n\n	'-'	skip three lines
\f	'1'	new page
\r	'+'	overstrike

A control character that ends a logical record is represented at the beginning of the following record in the external file. Since the ASA control character is in the first byte of each record, a record can hold only LRECL - 1 bytes of data. As with non-ASA text files described above, z/OS XL C/C++ adds blank padding to complete any record shorter than LRECL - 1 when it writes the record to the file. On input, z/OS XL C/C++ removes all trailing blanks. For example, if LRECL is 10, and you enter the string:

```
\nABC\nDEF
```

the record in the physical file will look like this:



On input, this string is read as follows:

```
\nABC\nDEF
```

You can lengthen and shorten records the same way as you can for non-ASA files. For more information about ASA, refer to Chapter 7, “Using ASA text files,” on page 47.

## Record

As with fixed-format text files, a record can hold LRECL bytes. Every call to `write()` is considered to be writing a full record. If you write fewer than LRECL bytes, z/OS XL C/C++ completes the record with enough nulls to make it LRECL bytes long. If you try to write more than that, z/OS XL C/C++ truncates the data.

## Blocked

Each call to `write()` creates a block that must be shorter than or equal to the size established by `BLKSIZE`. When you write less than `BLKSIZE` bytes, if the request is to create a new block, a short block will be created; if it is to update an existing block, only requested part of the block will be updated. If you try to write more than `BLKSIZE` at one time, z/OS XL C/C++ truncates the data. z/OS XL C/C++ will not check the provided data. You might need to take the following cases into consideration:



- Because all fixed-format records must be full, any block you write must be multiple of a record. Otherwise, z/OS XL C/C++ will fail the write request.
- When updating an FBS short block at the end of a file, it could be updated to a full block or a longer short block.
- When writing or appending to an FBS short block, z/OS XL C/C++ will use the request buffer to replace the previous block, which might extend or shrink the short block.
- You must make sure that there is no short block in the middle of the FBS data set.

## Variable-format records

In a file with variable-length records, each record may be a different length. The variable length formats permit both variable-length records and variable-length blocks. The first 4 bytes of each block are reserved for the Block Descriptor Word (BDW); the first 4 bytes of each record are reserved for the Record Descriptor Word (RDW), or, if you are using spanned files, the Segment Descriptor Word (SDW). Illustrations of variable-length records are shown in Figure 2 on page 17.

Once you have set the LRECL for a variable-format file, you can write up to LRECL minus 4 characters in each record. z/OS XL C/C++ does not let you see RDWs, BDWs, or SDWs when you open a file as variable-format. To see the RDWs or SDWs and BDWs, open the variable file as undefined-format, as described in “Undefined-format records” on page 19.

The value of LRECL must be greater than 4 to accommodate the RDW or SDW. The value of BLKSIZE must be greater than or equal to the value of LRECL plus 4. You should not use a BLKSIZE greater than LRECL plus 4 for an unblocked data set. Doing so results in buffers that are larger than they need to be. The largest amount of data that any one record can hold is LRECL bytes minus 4.

For striped data sets, a block is padded out to its full BLKSIZE. This makes specifying an unnecessarily large BLKSIZE very inefficient.

**Record format (RECFM):** You can specify the following formats for variable-length records:

<b>V</b>	Variable-length, unblocked
<b>VA</b>	Variable-length, ASA print control characters, unblocked
<b>VB</b>	Variable-length, blocked
<b>VM</b>	Variable-length, machine print-control codes, unblocked
<b>VS</b>	Variable-length, unblocked, spanned
<b>VBA</b>	Variable-length, blocked, ASA print control characters
<b>VBM</b>	Variable-length, blocked, machine print-control codes
<b>VBS</b>	Variable-length, blocked, spanned
<b>VSA</b>	Variable-length, spanned, ASA print control characters
<b>VSM</b>	Variable-length, spanned, machine print-control codes
<b>VBSA</b>	Variable-length, blocked, spanned, ASA print control characters
<b>VBSM</b>	Variable-length, blocked, spanned, machine print-control codes

**Note:** In general, all references in this guide to files with record format VB also refer to VBM and VBA. The specific behavior of ASA files (such as VBA) is explained in Chapter 7, “Using ASA text files,” on page 47.

V-format signifies unblocked variable-length records. Each record is treated as a block containing only one record.

VB-format signifies blocked variable-length records. Each block contains as many complete records as it can accommodate.

**Spanned records:** A spanned record is opened using both V and S in the format specifier. A spanned record is a variable-length record in which the length of the record can exceed the size of a block. If it does, the record is divided into segments and accommodated in two or more consecutive blocks. The use of spanned records allows you to select a block size, independent of record length, that will combine optimum use of auxiliary storage with the maximum efficiency of transmission.

VS-format specifies that each block contains only one record or segment of a record. The first 4 bytes of a block describe the block control information. The second 4 bytes contain record or segment control information, including an indication of whether the record is complete or is a first, intermediate, or last segment.

VBS-format differs from VS-format in that each block in VBS-format contains as many complete records or segments as it can accommodate, while each block in VS-format contains at most one record per block.

**V-format:**



**VB-format:**

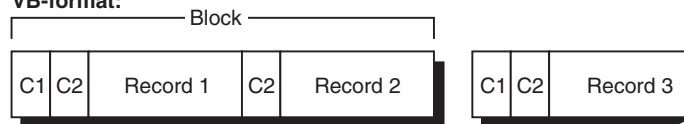

**VS-format:**

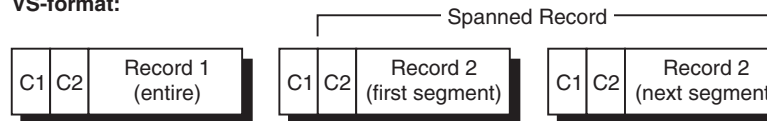

**VBS-format:**

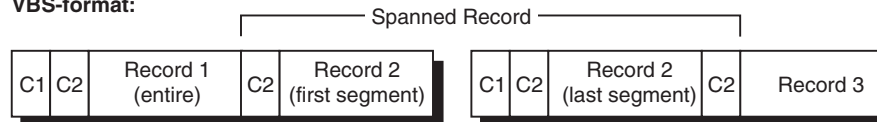

**C1:** Block control information  
**C2:** Record or segment control information

Figure 2. Variable-length records on z/OS

## Mapping C types to variable format:

### Binary

On input and output, data flows over record boundaries. Any record will hold up to LRECL minus 4 characters of data. If you try to write more than that, your data will go to the next record, after the RDW or SDW. You will not be able to see the descriptor words when you read the file.

**Note:** If you need to see the BDWs, RDWs, or SDWs, you can open and read a V-format file as a U-format file. See “Undefined-format records” on page 19 for more information.

z/OS XL C/C++ never creates empty binary records for files opened in V-format. See “Writing to binary files” on page 108 for more information. An empty binary record is one that contains only an RDW, which is 4 bytes long. On input, empty records are ignored.

### Text (non-ASA)

Record boundaries are used in the physical file to represent the position of the new-line character. You can indicate the end of a record by including a new-line or carriage return character in your data. In variable-format files, z/OS XL C/C++ treats the carriage return character as if it were a new-line. z/OS XL C/C++ does not write either of these characters to the physical file; instead, it creates a record boundary. When you read the file back, boundaries are read as new-lines.

If a record only contains a new-line character, the default behavior of z/OS XL C/C++ is to write a record containing a single blank to the file. Therefore, the string " \n" is treated the same way as the string "\n"; both are read back as "\n". All other blanks in your output are read back as is. Any empty (zero-length) record is ignored on input. However, if the environment variable `_EDC_ZERO_RECLLEN` was set to Y at the time the file was opened, a single new-line is written to the file as an empty record, and a single blank represents " \n". On input, an empty record is treated as a single new-line and is not ignored.

After a record has been written to a file, you cannot change its length. If you try to shorten a logical record by writing a new, smaller amount of data into it, the C I/O library will add blank characters until the record is full. Writing more data to a record than it can hold causes your data to be truncated unless you are writing to a standard stream or a terminal file. In this case, your output is split across multiple records. If truncation occurs, z/OS XL C/C++ raises SIGIOERR and sets both `errno` and the error flag.

**Note:** If you did not explicitly set the `_EDC_ZERO_RECLLEN` environment variable when you opened the file, you can update a record that contains a single blank to contain a non-blank character, thereby lengthening the logical record from '\n' to 'x\n'), where *x* is the non-blank character.

### Text (ASA)

z/OS XL C/C++ treats variable-format ASA text files similarly to the way it treats fixed-format ones. Empty records are always ignored in ASA variable-format files; for a record to be recognized, it must contain at least one character as the ASA control character. For more information about ASA, refer to Chapter 7, “Using ASA text files,” on page 47.

### Record

Each call to `fwrite()` creates a record that must be shorter than or equal to the size established by LRECL. If you try to write more than LRECL bytes

on one call to `fwrite()`, z/OS XL C/C++ will truncate your data. z/OS XL C/C++ never creates empty records using record I/O. On input, empty records are ignored unless you have set the `_EDC_ZERO_RECL` environment variable to Y. In this case, empty records are treated as records with length 0.

If your application sets `_EDC_ZERO_RECL` to Y, bear in mind that `fread()` returns back 0 bytes read, but does not set `errno`, and that both `feof()` and `ferror()` return 0 as well.

### Blocked

Each call to `fwrite()` creates a block that must be shorter than or equal to the size established by `BLKSIZE`. When you write less than `BLKSIZE` bytes, if the request is to create a new block, a short block will be created; if it is to update an existing block, only requested part of the block will be updated. If you try to write more than `BLKSIZE` at one time, z/OS XL C/C++ truncates the data. z/OS XL C/C++ will not check the provided data. You must make sure that BDWs, RDWs, and SDWs in a block are correct.

### Undefined-format records

Everything in an undefined-format file is treated as data, including control characters and record boundaries. Blocks in undefined-format records are variable-length; each block is considered a record.

It is impossible to have an empty record. Whatever you specify for `LRECL` has no effect on your data, but the value of `LRECL` must be less than or equal to the value you specify for `BLKSIZE`. Regardless of what you specify, z/OS XL C/C++ sets `LRECL` to zero when it creates an undefined-format file.

Reading a file in U-format enables you to read an entire block at once.

**Record format (RECFM):** You can specify the following formats for undefined-length records:

- U** Undefined-length
- UA** Undefined-length, ASA print control characters
- UM** Undefined-length, machine print-control codes

U, UA, and UM formats permit the processing of records that do not conform to F- and V-formats. The operating system treats each block as a record; your program must perform any additional blocking or deblocking.

You can read any file in U-format. This is useful if, for example, you want to see the BDWs and RDWs of a file that you have written in V-format.

### Mapping C types to undefined format:

#### Binary

When you are writing to an undefined-format file, binary data fills a block and then begins a new block.

#### Text (non-ASA)

Record boundaries (that is, block boundaries) are used in the physical file to represent the position of the new-line character. You can indicate the end of a record by including a new-line or carriage return character in your data. In undefined-format files, z/OS XL C/C++ treats the carriage return character as if it were a new-line. z/OS XL C/C++ does not write either of

these characters to the physical file; instead, it creates a record boundary. When you read the file back, these boundaries are read as new-lines.

If a record contains only a new-line character, z/OS XL C/C++ writes a record containing a single blank to the file regardless of the setting of the `_EDC_ZERO_RECLEN` environment variable. Therefore, the string `' \n'` (a single blank followed by a new-line character) is treated the same way as `'\n'`; both are written out as a single blank. On input, both are read as `'\n'`. All other blank characters are written and read as you intended.

After a record has been written to a file, you cannot change its length. If you try to shorten a logical record by writing a new, smaller amount of data into it, the C I/O library adds blank characters until the record is full. Writing more data to a record than it can hold will cause your data to be truncated unless you are writing to a standard stream or a terminal file. In these cases, your output is split across multiple records. If truncation occurs, z/OS XL C/C++ raises `SIGIOERR` and sets both `errno` and the error flag.

**Note:** You can update a record that contains a single blank to contain a non-blank character, thereby lengthening the logical record from `'\n'` to `'x\n'`, where `x` is the non-blank character.

#### **Text (ASA)**

For a record to be recognized, it must contain at least one character as the ASA control character. For more information about ASA, refer to Chapter 7, "Using ASA text files," on page 47.

#### **Record**

Each call to `fwrite()` creates a record that must be shorter than or equal to the size established by `BLKSIZE`. If you try to write more than `BLKSIZE` bytes on one call to `fwrite()`, z/OS XL C/C++ truncates your data.

#### **Blocked**

Each call to `fwrite()` creates a block that must be shorter than or equal to the size established by `BLKSIZE`. When you write less than `BLKSIZE` bytes, if the request is to create a new block, a short block will be created; if it is to update an existing block, only requested part of the block will be updated. If you try to write more than `BLKSIZE` at one time, z/OS XL C/C++ truncates the data. z/OS XL C/C++ will not check the provided data.

---

## **The byte stream model for C I/O**

The byte stream model differs from the record I/O model. In the byte stream model, a file is just a stream of bytes, with no record boundaries. New-line characters written to the stream appear in the external file.

If the file is opened in binary mode, any new-line characters previously written to the file are visible on input. z/OS XL C/C++ memory file I/O and Hiperspace memory file I/O are based on the byte stream model (see Chapter 14, "Performing memory file and hiperspace I/O operations," on page 201 for more information).

UNIX file system I/O, defined by POSIX, is also based on the byte stream model. See Chapter 11, "Performing z/OS UNIX file system I/O operations," on page 127 for information about I/O with UNIX file system.

## Mapping the C types of I/O to the byte stream model

### Binary

In the byte stream model, files opened in binary mode do not contain any record boundaries. Data is written as is to the file.

**Text** The byte stream model does not support ASA. New-lines, carriage returns, and other control characters are written as-is to the file.

### Record

If record I/O is supported by the kind of file you are using, z/OS XL C/C++ simulates it by treating new-line characters as record boundaries. New-lines are not treated as part of the record. A record written out with a new-line inside it is not read back as it was written, because z/OS XL C/C++ treats the new-line as a record boundary instead of data.

Files in z/OS UNIX file system support record I/O, but memory files do not.

As with all other record I/O, you can use only `fread()` and `fwrite()` to read from and write to files. Each call to `fwrite()` inserts a new-line in the byte stream; each call to `fread()` strips it off. For example, if you use one `fwrite()` statement to write the string ABC and the next to write DEF, the byte stream will look like this:



There are no limitations on lengthening and shortening records. If you then rewind the file and write new data into it, z/OS XL C/C++ will replace the old data. For example, if you used the `rewind()` function on the stream in the previous example and then called `fwrite()` to place the string 12345 into it, the stream would look like this:

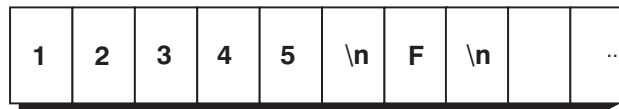

If you are using files with this model, do not use new-line characters in your output. If you do, they will create extra record boundaries. If you are unsure about the data being written or are writing numeric data, use binary instead of text to avoid writing a byte that has the hex value of a new-line.





---

## Chapter 4. Using the Standard C++ Library I/O Stream Classes

The object-oriented model for input and output (I/O) is a set of classes and header files that are provided by the Standard C++ Library. These classes implement and manage the stream buffers and the data held in the buffers. Stream buffers hold data sent to the program (input) and from the program (output), enabling the program to manipulate and format the data.

There are two base classes, `ios` and `streambuf`, from which all other I/O stream classes are derived. The `ios` class and its derivative classes are used to implement formatting of I/O and maintain error state information of stream buffers implemented with the `streambuf` class.

There are two shipped versions of the I/O stream classes:

- The UNIX Systems Laboratories C++ Language System Release (USL) I/O Stream Class Library

The UNIX Systems Laboratories C++ Language System Release (USL) I/O Stream Class Library is declared in the `iostream.h` header file. This version does not support ASCII and large files.

- The Standard C++ I/O stream classes

The Standard C++ I/O stream classes are declared in the `iostream` header file. This version supports ASCII and large files.

The I/O stream classes use `OBJECTMODEL(CLASSIC)`. They cannot be used with other classes that use `OBJECTMODEL(IBM)`, within the same inheritance hierarchy. For more information, see `OBJECTMODEL` in *z/OS XL C/C++ User's Guide*.

---

### Advantages to using the C++ I/O stream classes

Although input and output are implemented with streams for both C and C++, the C++ I/O stream classes provide the same facilities for input and output as C `stdio.h`. The I/O stream classes in the Standard C++ Library have the following advantages:

- The input (`>>`) operator and output (`<<`) operator are typesafe. These operators are easier to use than `scanf()` and `printf()`.
- You can overload the input and output operators to define input and output for your own types and classes. This makes input and output across types, including your own, uniform.

---

### Predefined streams for C++

z/OS XL C++ provides the following predefined streams:

<b>cin</b>	The standard input stream
<b>cout</b>	The standard output stream
<b>cerr</b>	The standard error stream, unit-buffered such that characters sent to this stream are flushed on each output operation
<b>clog</b>	The buffered error stream

All predefined streams are tied to `cout`. When you use `cin`, `cerr`, or `clog`, `cout` gets flushed sending the contents of `cout` to the ultimate consumer.

z/OS C standard streams create all I/O to I/O streams:

- Input to `cin` comes from `stdin` (unless `cin` is redirected)
- `cout` output goes to `stdout` (unless `cout` is redirected)
- `cerr` output goes to `stderr` (unit-buffered) (unless `cerr` is redirected)
- `clog` output goes to `stderr` (unless `clog` is redirected)

When redirecting or intercepting a C standard stream, the corresponding C++ standard stream becomes redirected. This applies unless you redirect an I/O stream. See Chapter 9, “Using C and C++ standard streams and redirection,” on page 63 for more information.

---

## How C++ I/O streams relate to C I/O streams

Typically, USL I/O Stream Class Library file I/O is implemented in terms of z/OS XL C file I/O, and is buffered from it.

**Note:** The only exception is that `cerr` is unit-buffered (that is, `ios::unitbuf` is set).

A `filebuf` object is associated with each `ifstream`, `ofstream`, and `fstream` object. When the `filebuf` is flushed, it writes to the underlying C stream, which has its own buffer. The `filebuf` object follows every `fwrite()` to the underlying C stream with an `fflush()`.

---

## Mixing the Standard C++ I/O stream classes, USL I/O stream class library, and C I/O library functions

It is not recommended to mix the usage of the Standard C++ I/O stream classes, USL I/O Stream Class Library, and C I/O library functions.

The USL I/O stream class library uses a separate buffer, which means that you would need to flush the buffer after each call to `cout` either by setting `ios::unitbuf` or by calling `sync_with_stdio()`.

You should avoid switching between the formatted extraction functions of the C++ I/O stream classes and C `stdio` library functions whenever possible. You should also avoid switching between versions of these classes.

For more information on mixing the I/O stream classes refer to “Interleaving the standard streams with `sync_with_stdio()`” on page 65 and “Interleaving the standard streams without `sync_with_stdio()`” on page 66.

---

## Specifying file attributes

The `fstream`, `ifstream`, and `ofstream` classes specialize stream input and output for files.

For z/OS XL C++, overloaded `fstream`, `ifstream`, and `ofstream` constructors, and `open()` member functions, with an additional parameter, are provided so you can specify z/OS XL C `fopen()` mode values. You can use this additional parameter to specify any z/OS XL C `fopen()` mode value except `type=record` or `type=blocked`. If

you choose to use a constructor without this additional parameter, you will get the default z/OS XL C `fopen()` file characteristics. Table 8 on page 35 describes the default `fopen()` characteristics.



---

## Chapter 5. Opening files

This chapter describes how to open I/O files. You can open files using the Standard C `fopen()` and `freopen()` library functions. Alternatively, if you want to use the C++ I/O stream classes, you can use the constructors for the `ifstream`, `ofstream` or `fstream` classes, or the `open()` member functions of the `filebuf`, `ifstream`, `ofstream` or `fstream` classes.

To open a file stream with a previously opened z/OS UNIX file descriptor, use the `fdopen()` function.

To open files with UNIX file system low-level I/O, use the `open()` function. For more information about opening files in UNIX file system, see Chapter 11, "Performing z/OS UNIX file system I/O operations," on page 127.

---

### Prototypes of functions

Table 5 summarizes the prototypes of various functions. For more detailed information about the C I/O stream functions, see *z/OS XL C/C++ Runtime Library Reference*. For more detailed information about the C++ I/O stream classes, see *Standard C++ Library Reference*, which discusses the Standard C++ I/O stream classes.

Table 5. Summary of prototype functions

Type of function	Prototype
C Library Functions	<pre>FILE *fopen(const char *filename, const char *mode);  FILE *freopen(const char *filename, const char *mode, FILE *stream);  FILE *fdopen(int fildes, char *mode);</pre>
USL I/O stream library functions	<pre>// ifstream constructor ifstream(const char* fname, int mode=ios::in,           int prot=filebuf::openprot);  // ifstream constructor; z/OS C++ extension ifstream(const char* fname, const char* fattr,           int mode=ios::in, int prot=filebuf::openprot);  // ifstream::open() void open(const char* fname, int mode=ios::in,           int prot=filebuf::openprot);  // z/OS C++ extension void open(const char* fname, const char* fattr,           int mode=ios::in, int prot=filebuf::openprot);  // ofstream constructor ofstream(const char* fname, int mode=ios::out,           int prot=filebuf::openprot);</pre>

Table 5. Summary of prototype functions (continued)

Type of function	Prototype
USL I/O stream library functions (continued)	<pre> // ofstream constructor; z/OS C++ extension ofstream(const char* fname, const char* fattr,           int mode=ios::out, int prot=filebuf::openprot);  // ofstream::open() void open(const char* fname, int mode=ios::out,           int prot=filebuf::openprot);  // z/OS C++ extension void open(const char* fname, const char* fattr,           int mode=ios::out, int prot=filebuf::openprot); // fstream constructor fstream(const char* fname, int mode,         int prot=filebuf::openprot);  // fstream constructor; z/OS C++ extension fstream(const char* fname, const char* fattr,         int mode, int prot=filebuf::openprot);  // fstream::open() void open(const char* fname, int mode,         int prot=filebuf::openprot);  // z/OS C++ extension void open(const char* fname, const char* fattr,         int mode, int prot=filebuf::openprot);  // filebuf::open() filebuf* open(const char* fname, int mode,              int prot=filebuf::openprot);  // z/OS C++ extension filebuf* open(const char* fname, const char* fattr,              int mode, int prot=filebuf::openprot); </pre>
Standard C++ I/O stream functions	<pre> // z/OS C++ Standard Library ifstream constructor ifstream(const char *, ios_base::openmode, const char * _A)  // z/OS C++ Standard Library ifstream::open void ifstream::open(const char *, ios_base::openmode, const char * _A) void ifstream::open(const char *, ios_base::open_mode, const char * _A)  // z/OS C++ Standard Library ofstream constructor ofstream(const char *, ios_base::openmode, const char * _A)  // z/OS C++ Standard Library ofstream::open void ofstream::open(const char *, ios_base::openmode, const char * _A) void ofstream::open(const char *, ios_base::open_mode, const char * _A)  // z/OS C++ Standard Library fstream constructor fstream(const char *, ios_base::openmode, const char * _A)  // z/OS C++ Standard Library fstream::open void fstream::open(const char *, ios_base::openmode, const char * _A) void fstream::open(const char *, ios_base::open_mode, const char * _A)  // C++ Standard Library filebuf::open filebuf::open(const char *, ios_base::openmode, const char * _A) filebuf::open(const char *, ios_base::open_mode, const char * _A) </pre>

---

## Categories of I/O

Table 6 lists the categories of I/O that z/OS XL C/C++ supports and points to the section where each category is described.

**Note:** CICS Data Queues and z/OS Language Environment Message File do not apply in AMODE 64 applications. Hiperspace Memory Files are opened as (regular) Memory Files since the size of a (regular) Memory File can exceed 2GB in AMODE 64 applications.

Table 6. Kinds of I/O supported by z/OS XL C/C++

Type of I/O	Suggested Uses and Supported Devices	Model	Detail
OS I/O	Used for dealing with the following kinds of files: <ul style="list-style-type: none"><li>• Generation data group</li><li>• MVS™ sequential DASD files</li><li>• Regular and extended partitioned data sets</li><li>• Tapes</li><li>• Printers</li><li>• Punch data sets</li><li>• Card reader data sets</li><li>• MVS inline JCL data sets</li><li>• MVS spool data sets</li><li>• Striped data sets</li><li>• Optical readers</li></ul>	Record	Link
UNIX file system I/O	Used under z/OS UNIX System Services (z/OS UNIX) to support data sets in the UNIX file system, and access the byte-oriented UNIX file system files according to POSIX .1 and XPG 4.2 interfaces. This increases the portability of applications written on UNIX-based systems to z/OS XL C/C++ systems.	Byte stream	Link
VSAM I/O	Used for working with VSAM data sets. Supports direct access to records by key, relative record number, or relative byte address. Supports entry-sequenced, relative record, and key-sequenced data sets.	Record	Link
Terminal I/O	Used to perform interactive input and output operations with a terminal.	Record	Link
Memory Files	Used for applications requiring temporary I/O files without the overhead of system data sets. Fast and efficient.	Byte stream	Link
Hiperspace Memory Files	Used to deal with memory files as large as 2 gigabytes.	Byte stream	Link
CICS Data Queues	Used under the Customer Information Control System (CICS). CICS data queues are automatically selected under CICS for the standard streams stdout and stderr for C, or cout and cerr for C++. The CICS I/O commands are supported through the Command Level interface. The standard stream stdin under C (or cin under C++) is treated as an empty file under CICS.	Record	Link
z/OS Language Environment Message File	Used when you are running with z/OS Language Environment. The message file is automatically selected for stderr under z/OS Language Environment. For C++, automatic selection is of cerr.	Record	Link

Table 7 on page 30 lists the environments that z/OS XL C/C++ supports, and which categories of I/O work in which environment.



Table 7. I/O categories and environments that support them

Type of I/O	MVS batch	IMS online	TSO	TSO batch	CICS
OS I/O	Yes	Yes	Yes	Yes	No
UNIX file system I/O	Yes	Yes	Yes	Yes	No
VSAM I/O	Yes	Yes	Yes	Yes	No
Terminal I/O	No	No	Yes	No	No
Memory Files	Yes	Yes	Yes	Yes	Yes
Hiperspace Memory Files	Yes	Yes	Yes	Yes	No
CICS Data Queues	No	No	No	No	Yes
z/OS Language Environment Message File	Yes	Yes	Yes	Yes	No

**Note:** MVS batch includes IMS batch. TSO is interactive. TSO batch indicates an environment set up by a batch call to IKJEFT01. Programs run in such an environment behave more like a TSO interactive program than an MVS batch program.

## Specifying what kind of file to use

This section discusses:

- the kinds of files you can use
- how to specify RECFM, LRECL, and BLKSIZE
- how to specify DDnames

### OS files

z/OS XL C/C++ treats a file as an OS file, provided that it is not a CICS data queue, or a UNIX file system, VSAM, memory, terminal, or Hiperspace file.

### UNIX file system files

When you are running under MVS, TSO (batch and interactive), or IMS, z/OS XL C/C++ recognizes a UNIX file system I/O file as such if the name specified on the `fopen()` or `freopen()` call conforms to certain rules. These rules are described in “How z/OS XL C/C++ determines what kind of file to open” on page 37.

### VSAM data sets

z/OS XL C/C++ recognizes a VSAM data set if the file exists and has been defined as a VSAM cluster before the call to `fopen()`.

### Terminal files

When you are running with the runtime option `POSIX(OFF)` under interactive TSO, z/OS XL C/C++ associates streams to the terminal. You can also call `fopen()` to open the terminal directly if you are running under TSO (interactive or batch), and either the file name you specify begins with an asterisk (\*), or the ddname has been allocated with a DSN of \*.

When running with `POSIX(ON)`, z/OS XL C/C++ associates streams to the terminal under TSO and a shell if the file name you have specified fits one of the following criteria:

- **Under TSO (interactive and batch)**, the name must begin with the sequence `//*`, or the ddname must have been allocated with a DSN of \*.

- **Under a shell**, the name specified on `fopen()` or `freopen()` must be the character string returned by `ttyname()`.

Interactive IMS and CICS behave differently from what is described here. For more information about terminal files with interactive IMS and CICS see Chapter 9, "Using C and C++ standard streams and redirection," on page 63.

If you are running with `POSIX(0N)` outside a shell, you must use the regular `z/OS XL C/C++` I/O functions for terminal I/O. If you are running with `POSIX(0N)` from a shell, you can use the regular `z/OS XL C/C++` I/O functions *or* the POSIX low-level functions (such as `read()`) for terminal I/O.

## Memory files and hiperspace memory files

You can use regular memory files on all the systems that `z/OS XL C/C++` supports. To create one, specify `type=memory` on the `fopen()` or `freopen()` call that creates the file. A memory file, once created, exists until either of the following happens:

- You explicitly remove it with `remove()` or `clrmemf()`
- The root program is terminated

While a memory file exists, you can just use another `fopen()` or `freopen()` that specifies the memory file's name. As sample program `CCNGOF1` shows in Figure 3, you do not have to specify `type=memory`.

---

```

/* this example shows how fopen() may be used with memory files */

#include <stdio.h>
char text[3], *result;
FILE * fp;

int main(void)
{
    fp = fopen("a.b", "w, type=memory"); /* Opens a memory file */
    fprintf(fp, "%d\n",10);              /* Writes to the file */
    fclose(fp);                          /* Closes the file */
    fp = fopen("a.b", "r");              /* Reopens the same */
                                        /* file (already */
                                        /* a memory file) */
    if ((result=fgets(text,3,fp)) !=NULL) /* Retrieves results */
        printf("value retrieved is %s\n",result);
    fclose(fp);                          /* Closes the file */

    return(0);
}

```

---

*Figure 3. Memory file example*

A valid memory file name will match current file restrictions on a real file. Thus, a memory file name that is classified as UNIX file system can have more characters than can one classified as an MVS file name.

If you are not running under CICS, you can open a Hiperspace memory file as follows:

```
fp = fopen("a.b", "w, type=memory(hiperspace)");
```

If you specify `hiperspace` and you are running in a CICS environment, `z/OS XL C/C++` opens a regular memory file. If you are running with the runtime options

POSIX(ON) and TRAP(OFF), specifying hiperspace has no effect; z/OS XL C/C++ will open a regular memory file. You must specify TRAP(ON) to be able to create Hiperspace files.

**Restriction:** Hiperspace is not supported in AMODE 64 applications. If you specify hiperspace in AMODE 64 applications, z/OS XL C/C++ opens a regular memory file.

## CICS data queues

A CICS transient data queue is a pathway to a single predefined destination. The destination can be a ddname, another transient data queue, a VSAM file, a terminal, or another CICS environment. The CICS system administrator defines the queues that are active during execution of CICS. All users who direct data to a given queue will be placing data in the same location, in order of occurrence.

You cannot use `fopen()` or `freopen()` to specify this kind of I/O. It is the category selected automatically when you call any ANSI functions that reference `stdout` and `stderr` under CICS. If you reference either of these in a C or C++ program under CICS, z/OS XL C/C++ attempts to open the CESO (`stdout`) or CESE (`stderr`) queue. If you want to write to any other queue, you should use the CICS-provided interface.

## z/OS Language Environment Message file

The z/OS Language Environment message file is managed by z/OS Language Environment and may not be directly opened or closed with `fopen()`, `freopen()` or `fclose()` within a C or C++ application. In z/OS Language Environment, output from `stderr` is directed to the z/OS Language Environment message file by default. You can use `freopen()` and `fclose()` to manage `stderr`, or you can redirect it to another destination. There are application writer interfaces (AWIs) that enable you to access the z/OS Language Environment message file directly. These are documented in *z/OS Language Environment Programming Guide*.

See Chapter 16, “Language Environment Message file operations,” on page 217 for more information on z/OS Language Environment message files.

## How to specify RECFM, LRECL, and BLKSIZE

For OS files and terminal files, the values of RECFM, LRECL, and BLKSIZE are significant. When you open a file, z/OS XL C/C++ searches for the RECFM, LRECL, and BLKSIZE values in the following places:

1. The `fopen()` or `freopen()` statement that opens the file
2. The DD statement (described in “DDnames” on page 36)
3. The values set in the existing file
4. The default values for `fopen()` or `freopen()`.

When you call `fopen()` and specify a write mode (`w`, `wb`, `w+`, `wb+`, `w+b`) for an existing file, z/OS XL C/C++ uses the default values for `fopen()` if:

- the data set is opened by the data set name or
- the data set is opened by ddname and the DD statement does not have any attributes filled in.

These defaults are listed in Table 8 on page 35. To force z/OS XL C/C++ to use existing attributes when you are opening a file, specify `recfm=*` (or `recfm=+`) on the `fopen()` or `freopen()` call.

recfm=\* (or reconfm=+) is valid only for existing DASD data sets. It is ignored in all other cases.

reconfm=+ is identical to reconfm=\* with the following exceptions:

- If there is no record format for the existing DASD data set, the defaults are assigned as if the data set did not exist.
- When append mode is used, the fopen() fails.

**Notes:**

1. When specifying a ddname on fopen() or freopen() you should be aware of the following when opening the ddname using one of the write modes:
2. If the ddname is allocated to an already existing file and that ddname has not yet been opened, then the DD statement will not contain the reconfm, lrecl, or blksize. That information is not filled in until the ddname is opened for the first time. If the first open uses one of the write modes (w,wb, w+, wb+, w+b) and reconfm=\* (or reconfm=+) is not specified, then the existing file attributes are not considered. Therefore, since the DD statement has not yet been filled in, the fopen() defaults are used.
3. If the ddname is allocated at the same time the file is created, then the DD statement will contain the same reconfm, lrecl, and blksize specified for the file. If the first open uses one of the write modes (w, wb, w+, wb+, w+b) and reconfm=\* (or reconfm=+) is not specified, then z/OS XL C/C++ picks up the existing file attributes from the DD statement since they were placed there at the time of allocation.

You can specify the record format in

- The RECFM parameter of the JCL DD statement under MVS
- The RECFM parameter of the ALLOCATE statement under TSO
- The \_\_reconfm field of the \_\_dyn\_t structure passed to the dynalloc() library function under MVS
- The RECFM parameter on the call to the fopen() or freopen() library function
- The \_\_S99TXTPP text unit field on an SVC99 parameter list passed to the svc99() library function under MVS
- The ISPF data set utility under MVS

Certain categories of I/O may ignore or simulate some attributes such as BLKSIZE or RECFM that are not physically supported on the device. Table 6 on page 29 lists all the categories of I/O that z/OS XL C/C++ supports and directs you to where you can find more information about them.

You can specify the logical record length in

- The LRECL parameter of the JCL DD statement under MVS
- The LRECL parameter of the ALLOCATE statement under TSO
- The \_\_lrecl field of the \_\_dyn\_t structure passed to the dynalloc() library function under MVS
- The LRECL parameter on the call to the fopen() or freopen() library function
- The \_\_S99TXTPP text unit field on an SVC99 parameter list passed to the svc99() library function under MVS
- The ISPF data set utility

If you are creating a file and you do not select a record size, z/OS XL C/C++ uses a default. See “fopen() defaults” for details on how defaults are calculated.

You can specify the block size in

- The BLKSIZE parameter of the JCL DD statement
- The BLKSIZE parameter of the ALLOCATE statement under TSO
- The `__blksize` field of the `__dyn_t` structure passed to the `dynalloc()` library function under MVS
- The BLKSIZE parameter on a call to the `fopen()` or `freopen()` library function
- The `__S99TXTPP` text unit field on an SVC99 parameter list passed to the `svc99()` library function under MVS
- The ISPF data set utility

If you are creating a file and do not select a block size, z/OS XL C/C++ uses a default. The defaults are listed in Table 8 on page 35.

## fopen() defaults

You cannot specify a file attribute more than once on a call to `fopen()` or `freopen()`. If you do, the function call fails. If the file attributes specified on the call to `fopen()` differ from the actual file attributes, `fopen()` usually fails. However, `fopen()` does not fail if:

- The file is opened for `w`, `w+`, `wb`, or `wb+`, and the file is neither an existing PDS or PDSE nor an existing file opened by a `ddname` that specifies `DISP=MOD`. In such instances, `fopen()` attributes override the actual file attributes. However, if `recfm=* (or reconfm=+)` is specified on the `fopen()`, any attributes that are not specified either on the `fopen()` or for the `ddname` will be retrieved from the existing file. If the final combination of attributes is invalid, the `fopen()` will fail.
- The file is opened for reading (`r` or `rb`) with `recfm=U`. Any other specified attributes should be compatible with those of the existing data set.

In calls to `fopen()`, the `LRECL`, `BLKSIZE`, and `RECFM` parameters are optional. (If you are opening a file for read or append, any attributes that you specify must match the existing attributes.)

If you do not specify file attributes for `fopen()` (or for an I/O stream object), you get the following defaults.

### RECFM defaults

If `recfm` is not specified in a `fopen()` call for an output binary file, `recfm` defaults to:

- `recfm=VB` for spool (printer) files
- `recfm=FB` otherwise

If `recfm` is not specified in a `fopen()` call for an output text file, `recfm` defaults to:

- `recfm=F` if `_EDC_ANSI_OPEN_DEFAULT` is set to `Y` and no `LRECL` or `BLKSIZE` specified. In this case, `LRECL` and `BLKSIZE` are both defaulted to 254.
- `recfm=VBA` for spool (printer) files.
- `recfm=U` for terminal files.
- `recfm=VB` for MVS files.
- `recfm=VB` for all other OS files.

If `recfm` is not specified for a record I/O file, you will get the default of `recfm=VB`.

### LRECL and BLKSIZE defaults

Table 8 shows the defaults for LRECL and BLKSIZE when z/OS XL C/C++ is creating a file, not appending or updating it. The table assumes that z/OS XL C/C++ has already processed any information from the `fopen()` statement or `ddname`. The defaults provide a basis for `fopen()` to select values for unspecified attributes when you create a file.

Table 8. `fopen()` defaults for LRECL and BLKSIZE when creating OS files

lrecl specified?	blksize specified?	RECFM	LRECL	BLKSIZE
no	no	All F	80	80
		All FB	80	maximum integral multiple of 80 less than or equal to <i>max</i>
		All V, VB, VS, or VBS	minimum of 1028 or <i>max-4</i>	<i>max</i>
		All U	0	<i>max</i>
yes	no	All F	<i>lrecl</i>	<i>lrecl</i>
		All FB	<i>lrecl</i>	maximum integral multiple of <i>lrecl</i> less than or equal to <i>max</i>
		All V	<i>lrecl</i>	<i>lrecl+4</i>
		All U	0	<i>lrecl</i>
no	yes	All F or FB	<i>blksize</i>	<i>blksize</i>
		All V, VB, VS, or VBS	minimum of 1028 or <i>blksize-4</i>	<i>blksize</i>
		All U	0	<i>blksize</i>

**Note:** "All" includes the standard (S) specifier for fixed formats, the ASA (A) specifier, and the machine control character (M) specifier.

In Table 8, the value *max* represents the maximum block size for the device. These are the current default maximum block sizes for several devices that z/OS XL C/C++ supports:

#### Device Block Size

##### DASD

6144

##### 3203 Printer

132

##### 3211 Printer

132

##### 4245 Printer

132

##### 2540 Reader

80

##### 2540 Punch

80

##### 2501 Reader

80

##### 3890 Document Processor

80

##### TAPE 32760

For more information about specific default block sizes, refer to *z/OS DFSMS Using Data Sets*.

For DASD files that do not have `recfm=U`, if you specify `blksize=0` on the call to `fopen()` or `freopen()`, the system determines the optimal block size for your file. If you do not have the correct level of DFP or you specify `blksize=0` for a `ddname` instead of specifying it on the `fopen()` or `freopen()` call, *z/OS XL C/C++* behaves as if you had not specified the `blksize` parameter at all.

For information about block sizes for different categories of I/O, see the chapters listed in Table 6 on page 29.

You do not have to specify the `LRECL` and `BLKSIZE` attributes; however, it is possible to have conflicting attributes when you do specify them. The restrictions are:

- For a `V` file, the `LRECL` must be greater than 4 bytes and must be at least 4 bytes smaller than the `BLKSIZE`.
- For an `F` file, the `LRECL` must be equal to the `BLKSIZE`, and must be at least 1.
- For an `FB` file, the `BLKSIZE` must be an integer multiple of the `LRECL`.
- For a `U` file, the `LRECL` must be less than or equal to the `BLKSIZE` and must be greater than or equal to 0. The `BLKSIZE` must be at least 1.
- In spanned files, the `LRECL` and the `BLKSIZE` attributes must be greater than 4.
- If you specify `LRECL=X`, the `BLKSIZE` attribute must be less than or equal to the maximum block size allowed on the device.

To determine the maximum `LRECL` and `BLKSIZE` values for the various file types and devices available on your operating system, refer to the chapters listed in Table 6 on page 29.

## DDnames

DD names are specified by prefixing the DD name with “DD:”. All the following forms of the prefix are supported:

- `DD:`
- `dd:`
- `dD:`
- `Dd:`

The DD statement enables you to write C source programs that are independent of the files and input/output devices they will use. You can modify the parameters of a file (such as `LRECL`, `BLKSIZE`, and `RECFM`) or process different files without recompiling your program.

- How to create a DDname under MVS batch

To create a `ddname` under MVS batch, you must write a JCL DD statement. For the C file `PARTS.INSTOCK`, you would write a JCL DD statement similar to the following:

```
//STOCK DD DSN=PARTS.INSTOCK, . . .
```

UNIX file system files can be allocated with a DD card, as shown in the following example:

```
//STOCK DD PATH='/u/parts.instock',  
//      PATHOPTS=(OWRONLY,OCREAT,OTRUNC),  
//      PATHMODE=(SIRWXU,SIRWXO,SIRWXG)
```



When defining DD, do not use DD ... FREE=CLOSE for unallocating DD statements. The C library may close files to perform some file operations such as `freopen()`, and the DD statement will be unallocated.

For more information on writing DD statements, refer to the JCL manuals listed in *z/OS V2R2 Information Roadmap*.

- How to create a DDname under TSO

To create a ddname under TSO, you must write an ALLOCATE command. For the declaration shown above for the C file STOCK, you should write a TSO ALLOCATE statement similar to the following:

```
ALLOCATE FILE(STOCK) DATASET('PARTS.INSTOCK')
```

You can also allocate UNIX file system files with TSO ALLOCATE commands. For example:

```
ALLOC FI(stock) PATH('/used/parts.stock') PATHOPTS(OWRONLY,OCREAT)  
PATHMODE(sirwxu,sirwxo,sirwxg)
```

See *z/OS V2R2 Information Roadmap* for more information on TSO ALLOCATE.

- How to create a DDname in source code

You can also use the z/OS XL C/C++ library functions `svc99()` and `dynalloc()` to allocate ddnames. See *z/OS XL C/C++ Runtime Library Reference* for more information about these functions.

You do not always need to describe the characteristics of the data in files both within the program and outside it. There are, in fact, advantages to describing the characteristics of your data in only one place.

Opening a file by ddname may require the merging of information internal and external to the program. If any conflict is detected that will prevent the opening of a file, `fopen()` returns a NULL pointer to indicate that the file cannot be opened. See *z/OS XL C/C++ Runtime Library Reference* for more information on `fopen()`.

If `DISP=MOD` is specified on a DD statement and if the file is opened in `w` or `wb` mode, the `DISP=MOD` causes the file to be opened in append mode rather than in write mode.

**Note:** You can open a ddname only with `fopen()` or `freopen()`. `open()` does not interpret ddnames as such.

---

## Avoiding Undesirable Results when Using I/O

File serialization is not provided for different tasks attempting to access the same file. When a C/C++ application is run on one task, and the same application or another C/C++ application is run on a different task, any attempts for both applications to access the same file is the responsibility of the application.

---

## How z/OS XL C/C++ determines what kind of file to open

This section describes the criteria that z/OS XL C/C++ uses to determine what kind of file it is opening. z/OS XL C/C++ goes through the categories listed in Table 6 on page 29 in the order that follows. If a category applies to a file, z/OS XL C/C++ stops searching.

**Note:** Files cannot be opened under CICS when you have specified the `POSIX(ON)` runtime option.



“Under TSO, MVS batch, IMS — POSIX(ON)” shows how z/OS XL C/C++ determines what type of file to open under TSO, MVS batch, and interactive IMS with POSIX(ON). For information on the types of files shown in the chart, see the appropriate chapter in the I/O section.

“Under TSO, MVS batch, IMS — POSIX(OFF)” on page 41 shows how z/OS XL C/C++ determines what type of file to open under TSO, MVS batch, and interactive IMS with POSIX(OFF). For information on the types of files shown in the chart, see the appropriate chapter in the I/O section.

“Under CICS” on page 43 shows how z/OS XL C/C++ determines what type of file to open under CICS. For information on the types of files shown in the chart, see the appropriate chapter in the I/O section.

## Under TSO, MVS batch, IMS — POSIX(ON) Procedure

1. Is type=memory specified?

Option	Description
Yes	See 2
No	See 5

2. Is hiperspace specified?

Option	Description
Yes	See 3
No	See 4

3.
  - a. z/OS XL C/C++ opens a memory file in Hiperspace.
4.
  - a. z/OS XL C/C++ opens a regular memory file.
5. Does the name begin with // but NOT ///?

Option	Description
Yes	See 6
No	See 7

6.
  - a. Continue at 8.
7.
  - a. Continue at 17 on page 39.
8. Is the next character an asterisk?

Option	Description
Yes	See 9
No	See 12 on page 39

9. Are you running under TSO interactive?

Option	Description
Yes	See 10
No	See 11

10.

- a. z/OS XL C/C++ opens a terminal file.

11.

- a. z/OS XL C/C++ removes the asterisk from the name unless the asterisk is the only character, and proceeds to 28 on page 40.

12. Is name of form DDname?

Option	Description
Yes	See 13
No	See 14

13.

- a. Continue to 29 on page 40.

14. Does the name specified match that of an existing memory file?

Option	Description
Yes	See 15
No	See 16

15.

- a. z/OS XL C/C++ opens the existing memory file.

16.

- a. z/OS XL C/C++ opens an OS file.

17. Is the name of the form \*DD:ddname or DD:ddname?

Option	Description
Yes	See 18
No	See 25 on page 40

18. Does ddname exist?

Option	Description
Yes	See 19
No	See 22 on page 40

19. Is a path specified in ddname?

Option	Description
Yes	See 20
No	See 21

20.

- a. z/OS XL C/C++ opens a UNIX file system file.

21.

- a. z/OS XL C/C++ opens an OS file.

22. Does a memory file exist?

Option	Description
Yes	See 23
No	See 24

23.

a. z/OS XL C/C++ opens the existing memory file.

24.

a. z/OS XL C/C++ opens a UNIX file system file called either \*DD:ddname or DD:ddname.

25. Does the name specified match that of an existing memory file?

Option	Description
Yes	See 26
No	See 27

26.

a. z/OS XL C/C++ opens the existing memory file.

27.

a. z/OS XL C/C++ opens a UNIX file system file.

28. Is the name of the form \*DD:ddname or DD:ddname?

Option	Description
Yes	See 29
No	See 36 on page 41

29. Does ddname exist?

Option	Description
Yes	See 30
No	See 33

30. Is a path specified in ddname?

Option	Description
Yes	See 31
No	See 32

31.

a. z/OS XL C/C++ opens a UNIX file system file.

32.

a. z/OS XL C/C++ opens an OS file.

33. Does a memory file exist?

Option	Description
Yes	See 34 on page 41
No	See 35 on page 41

- 34.
- a. z/OS XL C/C++ opens the existing memory file.
- 35.
- a. \*\*\*ERROR\*\*\*
36. Does the name specified match that of an existing memory file?

Option	Description
Yes	See 37
No	See 38

- 37.
- a. z/OS XL C/C++ opens the existing memory file.
- 38.
- a. z/OS XL C/C++ opens an OS file.

## Under TSO, MVS batch, IMS — POSIX(OFF) Procedure

1. Is type=memory specified?

Option	Description
Yes	See 2
No	See 5

2. Is hiperspace specified?

Option	Description
Yes	See 3
No	See 4

- 3.
- a. z/OS XL C/C++ opens a memory file in Hiperspace.
- 4.
- a. z/OS XL C/C++ opens a regular memory file.
5. Does the name begin with // but NOT ///?

Option	Description
Yes	See 6
No	See 7

- 6.
- a. Continue at 8.
- 7.
- a. Continue at 17 on page 42.
8. Is the next character an asterisk?

Option	Description
Yes	See 9 on page 42
No	See 12 on page 42

9. Are you running under TSO interactive?

Option	Description
Yes	See 10
No	See 11

10.

a. z/OS XL C/C++ opens a terminal file.

11.

a. z/OS XL C/C++ removes the asterisk from the name unless the asterisk is the only character, and proceeds to 17.

12. Is name of form DDname?

Option	Description
Yes	See 13
No	See 14

13.

a. Continue at 18.

14. Does the name specified match that of an existing memory file?

Option	Description
Yes	See 15
No	See 16

15.

a. z/OS XL C/C++ opens the existing memory file.

16.

a. z/OS XL C/C++ opens an OS file.

17. Is the name of the form \*DD:ddname or DD:ddname?

Option	Description
Yes	See 18
No	See 25 on page 43

18. Does ddname exist?

Option	Description
Yes	See 19
No	See 22 on page 43

19. Is a path specified in ddname?

Option	Description
Yes	See 20
No	See 21 on page 43

20.

a. z/OS XL C/C++ opens a UNIX file system file.

21.

- a. z/OS XL C/C++ opens an OS file.

22. Does a memory file exist?

Option	Description
Yes	See 23
No	See 24

23.

- a. z/OS XL C/C++ opens the existing memory file.

24.

- a. \*\*\*ERROR\*\*\*

25. Does the name specified match that of an existing memory file?

Option	Description
Yes	See 26
No	See 27

26.

- a. z/OS XL C/C++ opens the existing memory file.

27.

- a. z/OS XL C/C++ opens an OS file.

## Under CICS

### Procedure

1. Is type=memory specified?

Option	Description
Yes	See 2
No	See 5

2. Is hiperspace specified?

Option	Description
Yes	See 3
No	See 4

3. The fopen() call ignores the hiperspace specification and opens the memory file. See 8 on page 44

4.

- a. z/OS XL C/C++ opens the specified memory file.

5. Does the name specified match that of an existing memory file?

Option	Description
Yes	See 6
No	See 7 on page 44

6.

- a. z/OS XL C/C++ opens that memory file.

7. The `fopen()` call fails. See 8
8. End

---

## Chapter 6. Buffering of C streams

This chapter describes buffering modes used by z/OS XL C/C++ library functions available to control buffering and methods of flushing buffers.

z/OS XL C/C++ uses buffers to map C I/O to system-level I/O. When z/OS XL C/C++ performs I/O operations, it uses one of the following buffering modes:

- *Line buffering* - characters are transmitted to the system as a block when a new-line character is encountered. Line buffering is meaningful only for text streams and UNIX file system files.
- *Full buffering* - characters are transmitted to the system as a block when a buffer is filled.
- *No buffering* - characters are transmitted to the system as they are written. Only regular memory files and UNIX file system files support the no buffering mode.

The buffer mode affects the way the buffer is flushed. You can use the `setvbuf()` and `setbuf()` library functions to control buffering, but you cannot change the buffering mode after an I/O operation has used the buffer, as all read, write, and reposition operations do. In some circumstances, repositioning alters the contents of the buffer. It is strongly recommended that you only use `setbuf()` and `setvbuf()` before *any* I/O, to conform with ANSI, and to avoid any dependency on the current implementation. If you use `setvbuf()`, z/OS XL C/C++ may or may not accept your buffer for its internal use. For a hiperspace memory file, if the size of the buffer specified to `setvbuf()` is 8K or more, it will affect the number of hiperspace blocks read or written on each call to the operating system; the size is rounded down to the nearest multiple of 4K.

Full buffering is the default except in the following cases:

- If you are using an interactive terminal, z/OS XL C/C++ uses line buffering.
- If you are running under CICS, z/OS XL C/C++ also uses line buffering.
- `stderr` is line-buffered by default.
- If you are using a memory file, z/OS XL C/C++ does not use any buffering.

For terminals, because I/O is always unblocked, line buffering is equivalent to full buffering.

For record I/O files, buffering is meaningful only for blocked files or for record I/O files in z/OS UNIX file system using full buffering. For unblocked files, the buffer is full after every write and is therefore written immediately, leaving nothing to flush. For blocked files or fully-buffered UNIX file system files, however, the buffer can contain one or more records that have not been flushed and that require a flush operation for them to go to the system.

For blocked I/O files, buffering is always meaningless.

You can flush buffers to the system in several different ways.

- If you are using full buffering, z/OS XL C/C++ automatically flushes a buffer when it is filled.
- If you are using line buffering for a text file or a UNIX file system file, z/OS XL C/C++ flushes a buffer when you complete it with a control character. Except



for UNIX file system files, specifying line buffering for a record I/O, blocked I/O, or binary file has no effect; z/OS XL C/C++ treats the file as if you had specified full buffering.

- z/OS XL C/C++ flushes buffers to the system when you close a file or end a program.
- z/OS XL C/C++ flushes buffers to the system when you call the `fflush()` library function, with the following restrictions:
  - A file opened in text mode does not flush data if a record has not been completed with a new-line.
  - A file opened in fixed format does not flush incomplete records to the file.
  - An FBS file does not flush out a short block unless it is a DISK file opened without the NOSEEK parameter.
- All streams are flushed across non-POSIX `system()` calls. Streams are *not* flushed across POSIX `system()` calls. For a POSIX system call, we recommend that you do a `fflush()` before the `system()` call.

If you are reading a record that another user is writing to at the same time, you can see the new data if you call `fflush()` to refresh the contents of the input buffer.

**Note:** This is not supported for VSAM files.

You may not see output if a program that is using input and output fails, and the error handling routines cannot close all the open files.

---

## Chapter 7. Using ASA text files

This chapter describes the American Standards Association (ASA) text files, the control characters used in ASA files, how z/OS XL C/C++ translates the control characters, and how z/OS XL C/C++ treats ASA files during input and output. The first column of each record in an ASA file contains a control character (' ', '0', '-', '1', or '+') when it appears in the external medium.

z/OS XL C/C++ translates control characters in ASA files opened for text processing (r, w, a, r+, w+, a+ functions). On input, z/OS XL C/C++ translates ASA characters to sequences of control characters, as shown in Table 9. On output, z/OS XL C/C++ performs the reverse translation. The following sequences of control characters are translated, and the resultant ASA character becomes the first character of the following record.

Table 9. C control to ASA characters translation table

C Control Character Sequence	ASA Character	Description
\n	' '	skip one line
\n\n	'0'	skip two lines
\n\n\n	'-'	skip three lines
\f	'1'	new page
\r	'+'	overstrike

If you are writing to the first record or byte of the file and the output data does not start with a translatable sequence of C control characters, the ' ' ASA control character is written to the file before the specified data.

z/OS XL C/C++ does not translate or verify control characters when you open an ASA file for binary, record I/O, or blocked I/O.

---

### Example of writing to an ASA file

Sample program CCNGAS1, shown in Figure 4 on page 48, demonstrates how a program can write to an ASA file.

---

```

/* this example shows how to write to an ASA file */

#include <stdio.h>
#define MAX_LEN 80

int main(void) {
    FILE *fp;
    int i;
    char s[MAX_LEN+1];
    fp = fopen("asa.file", "w, recfm=fba");
    if (fp != NULL) {
        fputs("\n\nabcdef\r345\n\n", fp);
        fputs("\n\n9034\n", fp);
        fclose(fp);

        return(0);
    }

    fp = fopen("asa.file", "r");
    for (i = 0; i < 5; i++) {
        fscanf(fp, "%s", s[0]);
        printf("string = %s\n",s);
    }
}

```

---

*Figure 4. ASA Example*

The program writes five records to the file `asa.file`, as follows. Note that the last record is 9034. The last single '\n' does not create a record with a single control character (' '). If this same file is opened for read, and the `getc()` function is called to read the file 1 byte at a time, the same characters as those that were written out by `fputs()` in the first program are read.

```

0abcdef
1
+345
-
9034

```

---

## ASA file control

ASA files are treated as follows:

- If the first record written does not begin with a control character, then a single new-line is written and then followed by data; that is, the ASA character defaults to a space when none is specified.
- In ASA files, control characters are treated the same way that they are treated in other text files, with the following exceptions (see Table 9 on page 47 for more information):

**'\f' — form feed**

Defines a record boundary and determines the ASA character of the following record

**'\n' — new-line**

Does either of these:

- Define a record boundary and determines the ASA character of the following record.
- Modify the preceding ASA character if the current position is directly after an ASA character of ' ' or '0'.

**'\r' — carriage return**

Defines a record boundary and determines the ASA character of the following record.

- Records are terminated by writing a new-line ('\n'), carriage return ('\r'), or form feed ('\f') character.

- An ASA character can be updated to any other ASA character.

Updates made to any of the C control characters that make up an ASA character cause the ASA character to change.

If the file is positioned directly after a ' ' or '0' ASA character, writing a '\n' character changes the ASA character to a '0' or '-' respectively. However, if the ASA character is a '-', '1' or '+', the '\n' truncates the record (that is, it adds blank padding to the end of the record), and causes the following record's ASA character to be written as a ' '. Writing a '\f' or '\r' terminates the record and start a new one, but writing a normal data character simply overwrites the first data character of the record.

- You cannot overwrite the ASA character with a normal data character. The position at the start of a record (at the ASA character) is the logical end of the previous record. If you write normal data there, you are writing to the end of the previous record. z/OS XL C/C++ truncates data for the following files, except when they are standard streams:

- Variable-format files
- Undefined-format files
- Fixed-format files in which the previous record is full of data

When truncation occurs, z/OS XL C/C++ raises SIGIOERR and sets both errno and the error flag.

- Even when you update an ASA control character, seeking to a previously recorded position still succeeds. If the recorded position was at a control character that no longer exists (because of an update), the reposition is to the next character. Often, this is the first data character of the record.

For example, if you have the following string, you have saved the position of the third new-line:

**\n\n\nHELLO WORLD**

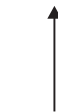

**x = ftell()**

If you then update the ASA character to a form feed ('\f'), the logical ASA position x no longer exists:

**\fHELLO WORLD**

If you call fseek() with the logical position x, it repositions to the next valid character, which is the letter 'H':

**\fHELLO WORLD**



**fseek() to pos x**

- If you try to shorten a record when you are updating it, z/OS XL C/C++ adds enough blank padding to fill the record.
- The ASA character can represent up to three new-lines, which can increase the logical record length by 1 or 2 bytes.
- Extending a fixed logical record on update implies that the logical end of the line follows the last written non-blank character.
- If an undefined text record is updated, the length of the physical records does not change. If the replacement record is:
  - *Longer* - data characters beyond the record boundary are truncated. At the point of truncation, the User error flag is set and SIGIOERR is raised (if the signal is not set up to be ignored). Truncation continues until you do one of these:
    1. Write a new-line character, carriage return, or form feed to complete the current record
    2. Close the file explicitly or implicitly at termination
    3. Reposition to another position in the file.
  - *Shorter* - the blank character is used to overwrite the rest of the record.
- If you close an ASA file that has a new-line as its last character, z/OS XL C/C++ does not write the new-line to the physical file. The next time you read from the file or update it, z/OS XL C/C++ returns the new-line to the end of the file. An exception to this rule happens when you write only a new-line to a new file. In this case, z/OS XL C/C++ does not truncate the new-line; it writes a single blank to the file. On input, however, you will read two new-lines.
- Using ASA format to read a file that contains zero-length records results in undefined behavior.
- You may have trouble updating a file if two ASA characters are next to each other in the file. For example, if there is a single-byte record (containing only an ASA character) immediately followed by the ASA character of the next record, you are positioned at or within the first ASA character. If you then write a sequence of '\n' characters intended to update both ASA characters, the '\n's will be absorbed by the first ASA character before overflowing to the next record. This absorption may affect the crossing of record boundaries and cause truncation or corruption of data.

At least one normal intervening data character (for example, a space) is required between '\n' and '\n' to differentiate record boundaries.

**Note:** Be careful when you update an ASA file with data containing more than one consecutive new-line: the result of the update depends on how the original ASA records were structured.

- If you are writing data to a non-blocked file without intervening flush or reposition requests, each record is written to the system on completion (that is, when a '\n', '\r' or '\f' character is written or when the file is closed).  
If you are writing data to a blocked file without intervening flush or reposition requests, and the file is opened in full buffering mode, the block is written to the system on completion of the record that fills the block. If the blocked file is line buffered, each record is written to the system on completion.  
If you are writing data to a spanned file without intervening flush or reposition requests, and the record spans multiple blocks, each block is written to the system once it is full and the user writes an additional byte of data.
- If a flush occurs while an ASA character indicating more than one new-line is being updated, the remaining new-lines will be discarded and a read will

continue at the first data character. For example, if '\n\n\n' is updated to be '\n\n' and a flush occurs, then a '0' will be written out in the ASA character position.



---

## Chapter 8. z/OS XL C Support for the double-byte character set

The number of characters in some languages such as Japanese or Korean is larger than 256, the number of distinct values that can be encoded in a single byte. The characters in such languages are represented in computers by a sequence of bytes, and are called multibyte characters. This chapter explains how the z/OS XL C compiler supports multibyte characters.

**Note:** The z/OS XL C++ compiler does not have native support for multibyte characters. The support described here is what z/OS XL C provides; for C++, you can take advantage of this support by using interlanguage calls to C code. Please refer to Chapter 19, “Using Linkage Specifications in C or C++,” on page 239 for more information.

The z/OS XL C compiler supports the IBM EBCDIC encoding of multibyte characters, in which each natural language character is uniquely represented by one to four bytes. The number of bytes that encode a single character depends on the *global shift state information*. If a stream is in initial shift state, one multibyte character is represented by a byte or sequence of bytes that has the following characteristics:

- It starts with the byte containing the shift-out (0x0e) character.
- The shift-out character is followed by 2 bytes that encode the value of the character.
- These bytes may be followed by a byte containing the shift-in (0x0f) character.

If the sequence of bytes ends with the shift-in character, the state remains initial, making this sequence represent a 4-byte multibyte character. Multibyte characters of various lengths can be normalized by the set of z/OS XL C library functions and encoded in units of one length. Such normalized characters are called wide characters; in z/OS XL C they are represented by two bytes. Conversions between multibyte format and wide character format can be performed by string conversion functions such as `wcstombs()`, `mbstowcs()`, `wcsrtoombs()`, and `mbsrtowcs()`, as well by the family of the wide character I/O functions. `MB_CUR_MAX` is defined in the `stdlib.h` header file. Depending on its value, either of the following happens:

- When `MB_CUR_MAX` is 1, all bytes are considered single-byte characters; shift-out and shift-in characters are treated as data as well.
- When `MB_CUR_MAX` is 4:
  - On input, the wide character I/O functions read the multibyte character from the streams, and convert them to the wide characters.
  - On output, they convert wide characters to multibyte characters and write them to the output streams.

Both binary and text streams have *orientation*. Streams opened with `type=record` or `type=blocked` do not. There are three possible orientations of a stream:

### Non-oriented

A stream that has been associated with an open file before any I/O operation is performed. The first I/O operation on a non-oriented stream will set the orientation of the stream. The `fwide()` function may be used to set the orientation of a stream before any I/O operation is performed. You



can use the `setbuf()` and `setvbuf()` functions only when I/O has not yet been performed on a stream. When you use these functions, the orientation of the stream is not affected. When you perform one of the wide character input/output operations on a non-oriented stream, the stream becomes *wide-oriented*. When you perform one of the byte input/output operations on a non-oriented stream, the stream becomes *byte-oriented*.

### Wide-oriented

A stream on which any wide character input/output functions are guaranteed to operate correctly. Conceptually, wide-oriented streams are sequences of wide characters. The external file associated with a wide-oriented stream is a sequence of *multibyte* characters. Using byte I/O functions on a wide-oriented stream results in undefined behavior. A stream opened for record I/O or blocked I/O cannot be wide-oriented.

### Byte-oriented

A stream on which any byte input/output functions are guaranteed to operate properly. Using wide character I/O functions on a byte input/output stream results in undefined behavior. Byte-oriented streams have minimal support for multibyte characters.

Calls to the `clearerr()`, `feof()`, `ferror()`, `fflush()`, `fgetpos()`, or `ftell()` functions do not change the orientation. Other functions that do not change the orientation are `ftello()`, `fsetpos()`, `fseek()`, `fseeko()`, `rewind()`, `fldata()`, and `fileno()`. Also, the `perror()` function does not affect the orientation of the `stderr` stream.

Once you have established a stream's orientation, the only way to change it is to make a successful call to the `freopen()` function, which removes a stream's orientation.

The `wchar.h` header file declares the `WEOF` macro and the functions that support wide character input and output. The macro expands to a constant expression of type `wint_t`. Certain functions return `WEOF` type when the end-of-file is reached on the stream.

**Note:** The behavior of the wide character I/O functions is affected by the `LC_CTYPE` category of the current locale, and the setting of `MB_CUR_MAX`. Wide-character input and output should be performed under the same `LC_CTYPE` setting. If you change the setting between when you read from a file and when you write to it, or vice versa, you may get undefined behavior. If you change it back to the original setting, however, you will get the behavior that is documented. See the introduction of this chapter for a discussion of the effects of `MB_CUR_MAX`.

---

## Opening files

You can use the `fopen()` or `freopen()` library functions to open I/O files that contain multibyte characters. You do not need to specify any special parameters on these functions for wide character I/O.

---

## Reading streams and files

Wide character input functions read multibyte characters from the stream and convert them to wide characters. The conversion process is performed in the same way that the `mbrtowc()` function performs conversions. The following z/OS XL C library functions support wide character input:

- `fgetwc()`

- `fgetwc_unlocked()`
- `fgetws()`
- `fgetws_unlocked()`
- `fwscanf()`
- `fwscanf_unlocked()`
- `getwc()`
- `getwc_unlocked()`
- `getwchar()`
- `getwchar_unlocked()`
- `vfwscanf()`
- `vfwscanf_unlocked()`
- `vwscanf()`
- `vwscanf_unlocked()`
- `wscanf()`
- `wscanf_unlocked()`

In addition, the following byte-oriented functions support handling multibyte characters by providing conversion specifiers to handle the `wchar_t` data type:

- `fscanf()`
- `fscanf_unlocked()`
- `scanf()`
- `scanf_unlocked()`
- `vfscanf()`
- `vfscanf_unlocked()`
- `vscanf()`
- `vscanf_unlocked()`

All other byte-oriented input functions treat input as single-byte.

For a detailed description of unformatted and formatted I/O functions, see *z/OS XL C/C++ Runtime Library Reference*.

The wide-character input/output functions maintain global shift state for multibyte character streams they read or write. For each multibyte character they read, wide-character input functions change global shift state as the `mbrtowc()` function would do. Similarly, for each multibyte character they write, wide-character output functions change global shift state as the `wcrtomb()` function would do.

When you are using wide-oriented input functions, multibyte characters are converted to wide characters according to the current shift state. Invalid double-byte character sequences cause conversion errors on input. As *z/OS XL C* uses wide-oriented functions to read a stream, it updates the shift state when it encounters shift-out and shift-in characters. Wide-oriented functions always read complete multibyte characters. Byte-oriented functions do not check for complete multibyte characters, nor do they maintain information about the shift state. Therefore, they should not be used to read multibyte streams.

For binary streams, no validation is performed to ensure that records start or end in initial shift state. For text streams, however, all records must start and end in initial shift state.

---

## Writing streams and files

Wide character output functions convert wide characters to multibyte characters and write the result to the stream. The conversion process is performed in the same way that the `wcrtomb()` function performs conversions.

The following z/OS XL C functions support wide character output:

- `fputwc()`
- `fputwc_unlocked()`
- `fputws()`
- `fputws_unlocked()`
- `fwprintf()`
- `fwprintf_unlocked()`
- `putwc()`
- `putwc_unlocked()`
- `putwchar()`
- `putwchar_unlocked()`
- `vfwprintf()`
- `vfwprintf_unlocked()`
- `wprintf()`
- `wprintf_unlocked()`

In addition, the following byte-oriented functions support handling multibyte characters by providing conversion specifiers to handle the `wchar_t` data type:

- `fprintf()`
- `fprintf_unlocked()`
- `printf()`
- `printf_unlocked()`
- `vfprintf()`
- `vfprintf_unlocked()`
- `vprintf()`
- `vprintf_unlocked()`

All other output functions do not support the `wchar_t` data type. However, all of the output functions support multibyte character output for text streams if `MB_CUR_MAX` is 4.

For a detailed description of unformatted and formatted I/O functions, see *z/OS XL C/C++ Runtime Library Reference*.

## Writing text streams

When you are using wide-oriented output functions, wide characters are converted to multibyte characters. For text streams, all records must start and end in initial shift state. The wide-character functions add shift-out and shift-in characters as they are needed. When the file is closed, a shift-out character may be added to complete the file in initial shift state.

When you are using byte-oriented functions to write out multibyte data, z/OS XL C starts each record in initial shift state and makes sure you complete each record in initial shift state before moving to the next record. When a string starts with a shift-out, all data written is treated as multibyte, not single-byte. This means that you cannot write a single-byte control character (such as a new-line) until you complete the multibyte string with a shift-in character.

Attempting to write a second shift-out character before a shift-in is not allowed. z/OS XL C truncates the second shift-out and raises SIGIOERR if SIGIOERR is not set to SIG\_IGN.

When you write a shift-in character to an incomplete multibyte character, z/OS XL C completes the multibyte character with a padding character (0xfe) before it writes the shift-in. The padding character is not counted as an output character in the total returned by the output function; you will never get a return code indicating that you wrote more characters than you provided. If z/OS XL C adds a padding character, however, it does raise SIGIOERR, if SIGIOERR is not set to SIG\_IGN.

Control characters written before the shift-in are treated as multibyte data and are not interpreted or validated.

When you close the file, z/OS XL C ensures that the file ends in initial shift state. This may require adding a shift-in and possibly a padding character to complete the last multibyte character, if it is not already complete. If padding is needed in this case, z/OS XL C does not raise SIGIOERR.

Multibyte characters are never split across record boundaries. In addition, all records end and start in initial shift state. When a shift-out is written to the file, either directly or indirectly by wide-oriented functions, z/OS XL C calculates the maximum number of complete multibyte characters that can be contained in the record with the accompanying shift-in. If multibyte output (including any required shift-out and shift-in characters) does not fit within the current record, the behavior depends on what type of file it is (a memory file has no record boundaries and so never has this particular problem). For a standard stream or terminal file, data is wrapped from one record to the next. Shift characters may be added to ensure that the first record ends in initial shift state and that the second record starts in the required shift state.

For files that are not standard streams, terminal files, or memory files, any attempt to write data that does not fit into the current record results in data truncation. In such a case, the output function returns an error code, raises SIGIOERR, and sets `errno` and the error flag. Truncation continues until initial state is reached and a new-line is written to the file. An entire multibyte stream may be truncated, including the shift-out and shift-in, if there are not at least two bytes in the record. For a wide-oriented stream, truncation stops when a `wchar_t` new-line character is written out.

Updating a wide-oriented file or a file containing multibyte characters is strongly discouraged, because your update may overwrite part of a multibyte string or character, thereby invalidating subsequent data. For example, you could inadvertently add data that overwrites a shift-out. The data after the shift-out is meaningless when it is treated in initial shift state. Appending new data to the end of the file is safe.

## Writing binary streams

When you are using wide-oriented output functions, wide characters are converted to multibyte characters. No validation is performed to ensure that records start or end in initial shift state. When the file is closed, any appends are completed with a shift-in character, if it is needed to end the stream in initial shift state. If you are updating a record when the stream is closed, the stream is flushed. See “Flushing buffers” for more information.

Byte-oriented output functions do not interpret binary data. If you use them for writing multibyte data, ensure that your data is correct and ends in initial shift state.

Updating a wide-oriented file or a file containing multibyte characters is strongly discouraged, because your update may overwrite part of a multibyte string or character, thereby invalidating subsequent data. For example, you could inadvertently add data that overwrites a shift-out. The data after the shift-out is meaningless when it is treated in initial shift state. Appending new data to the end of the file is safe for a wide-oriented file.

If you update a record after you call `fgetpos()`, the shift state may change. Using the `fpos_t` value with the `fsetpos()` function may cause the shift state to be set incorrectly.

---

## Flushing buffers

You can use the library function `fflush()` to flush streams to the system. For more information about `fflush()`, see the *z/OS XL C/C++ Runtime Library Reference*.

The action taken by the `fflush()` library function depends on the buffering mode associated with the stream and the type of stream. If you call one z/OS XL C program from another z/OS XL C program by using the ANSI `system()` function, all open streams are flushed before control is passed to the callee. A call to the POSIX `system()` function does not flush any streams to the system. For a POSIX system call, we recommend that you do a `fflush()` before the system call.

## Flushing text streams

When you call `fflush()` after updating a text stream, `fflush()` calculates your current shift state. If you are not in initial shift state, z/OS XL C looks forward in the record to see whether a shift-in character occurs before the end of the record or any shift-out. If not, z/OS XL C adds a shift-in to the data if it will not overwrite a shift-out character. The shift-in is placed such that there are complete multibyte characters between it and the shift-out that took the data out of initial state. z/OS XL C may accomplish this by skipping over the next byte in order to leave an even number of bytes between the shift-out and the added shift-in.

Updating a wide-oriented or byte-oriented multibyte stream is strongly discouraged. In a byte-oriented stream, you may have written only half of a multibyte character when you call `fflush()`. In such a case, z/OS XL C adds a padding byte before the shift-out. For both wide-oriented and byte-oriented streams, the addition of any shift or padding character does not move the current file position.

Calling `fflush()` has no effect on the current record when you are writing new data to a wide-oriented or byte-oriented multibyte stream, because the record is incomplete.

## Flushing binary streams

In a wide-oriented stream, calling `fflush()` causes z/OS XL C to add a shift-in character if the stream does not already end in initial shift state. In a byte-oriented stream, calling `fflush()` causes no special behavior beyond what a call to `fflush()` usually does.

## `ungetwc()` considerations

`ungetwc()` pushes wide characters back onto the input stream for binary and text files. You can use it to push one wide character onto the `ungetwc()` buffer. Never use `ungetc()` on a wide-oriented file. After you call `ungetwc()`, calling `fflush()` backs up the file position by one wide character and clears the pushed-back wide character from the stream. Backing up by one wide character skips over shift characters and backs up to the start of the previous character (whether single-byte or double-byte). For text files, z/OS XL C counts the new-lines added to the records as single-byte characters when it calculates the file position. For example, if you have the following stream,

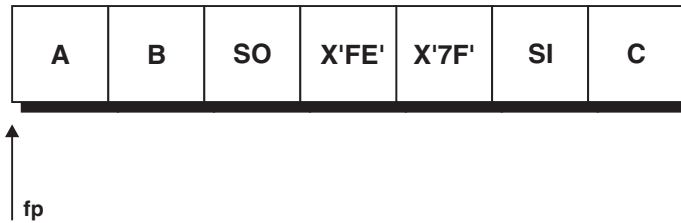

you can run the code fragment shown in Figure 5.

---

```
fgetwc(fp); /* Returns X'00C1' (the hexadecimal */
           /* wchar representation of A) */
fgetwc(fp); /* Returns X'00C2' (the hexadecimal */
           /* wchar representation of B) */
fgetwc(fp); /* Returns X'7FFE' (the hexadecimal */
           /* wchar representation of the DBCS */
           /* character) between the SO and SI */
           /* characters; leaves file position at C */
ungetwc('Z',fp); /* Logically inserts Z before SI character */
fflush(fp); /* Backs up one wchar, leaving position at */
           /* beginning of X'7FFE' DBCS char */
           /* and DBCS state in double-byte mode; */
           /* clears Z from the logical stream */
```

---

Figure 5. `ungetwc()` Example

You can set the `_EDC_COMPAT` environment variable before you open the file, so that `fflush()` ignores any character pushed back with `ungetwc()` or `ungetc()`, and leaves the file position where it was when `ungetwc()` or `ungetc()` was first issued. Any characters pushed back are still cleared. For more information about `_EDC_COMPAT`, see Chapter 32, “Using environment variables,” on page 467.

---

## Setting positions within files

The following conditions apply to text streams and binary streams.

### Repositioning within text streams

When you use the `fseek()` or `fsetpos()` function to reposition within files, z/OS XL C recalculates the shift state.

If you update a record after a successful call to the `fseek()` function or the `fsetpos()` function, a partial multibyte character can be overwritten. Calling a wide character function for data after the written character can result in undefined behavior.

Use the `fseek()` or `fsetpos()` functions to reposition only to the start of a multibyte character. If you reposition to the middle of a multibyte character, undefined behavior can occur.

## Repositioning within binary streams

When you are working with a wide-oriented file, keep in mind the state of the file position that you are repositioning to. If you call `ftell()`, you can seek with `SEEK_SET` and the state will be reset correctly. You cannot use such an `ftell()` value across a program boundary unless the stream has been marked wide-oriented. A seek specifying a relative offset (`SEEK_CUR` or `SEEK_END`) will change the state to initial state. Using relative offsets is strongly discouraged, because you may be seeking to a point that is not in initial state, or you may end up in the middle of a multibyte character, causing wide-oriented functions to give you undefined behavior. These functions expect you to be at the beginning or end of a multibyte character in the correct state. Using your own offset with `SEEK_SET` also does the same. For a wide-oriented file, the number of valid bytes or records that `ftell()` supports is cut in half.

When you use the `fsetpos()` function to reposition within a file, the shift state is set to the state saved by the function. Use this function to reposition to a wide character that is not in the initial state.

## ungetwc() considerations

For text files, the library functions `fgetpos()` and `ftell()` take into account the character you have pushed back onto the input stream with `ungetwc()`, and move the file position back by one wide character. The starting position for an `fseek()` call with a whence value of `SEEK_CUR` also takes into account this pushed-back wide character. Backing up one wide character means backing up either a single-byte character or a multibyte character, depending on the type of the preceding character. The implicit new-lines at the end of each record are counted as wide characters.

For binary files, the library functions `fgetpos()` and `ftell()` also take into account the character you have pushed back onto the input stream with `ungetwc()`, and adjust the file position accordingly. However, the `ungetwc()` must push back the same type of character just read by `fgetwc()`, so that `ftell()` and `fgetpos()` can save the state correctly. An `fseek()` with an offset of `SEEK_CUR` also accounts for the pushed-back character. Again, the `ungetwc()` must unget the same type of character for this to work properly. If the `ungetwc()` pushes back a character in the opposite state, you will get undefined behavior.

You can make only one call to `ungetwc()`. If the current logical file position is already at or before the first `wchar` in the file, a call to `ftell()` or `fgetpos()` after `ungetwc()` fails.

When you are using `fseek()` with a whence value of `SEEK_CUR`, the starting point for the reposition also accounts for the presence of `ungetwc()` characters and compensates as `ftell()` and `fgetpos()` do. Specifying a relative offset other than 0 is not supported and results in undefined behavior.



You can set the `_EDC_COMPAT` environment variable to specify that `ungetwc()` should not affect `fgetpos()` or `fseek()`. (It will still affect `ftell()`.) If the environment variable is set, `fgetpos()` and `fseek()` ignore any pushed-back wide character. See Chapter 32, “Using environment variables,” on page 467 for more information about `_EDC_COMPAT`.

If a repositioning operation fails, z/OS XL C attempts to restore the original file position by treating the operation as a call to `fflush()`. It does not account for the presence of `ungetwc()` characters, which are lost.

---

## Closing files

z/OS XL C expects files to end in initial shift state. For binary byte-oriented files, you must ensure that the ending state of the file is initial state. Failure to do so results in undefined behavior if you reaccess the file again. For wide-oriented streams and byte-oriented text streams, z/OS XL C tracks new data that you add. If necessary, z/OS XL C adds a padding byte to complete any incomplete multibyte character and a shift-in to end the file in initial state.

---

## Manipulating wide character array functions

To manipulate wide character arrays in your program, you can use the functions shown in Table 10. For more information about these functions, refer to *z/OS XL C/C++ Runtime Library Reference*.

*Table 10. Manipulating wide character arrays*

Function	Purpose
<code>wmemcmp()</code>	Compare wide character
<code>wmemchr()</code>	Locate wide character
<code>wmemcpy()</code>	Copy wide character
<code>wmemmove()</code>	Move wide character
<code>wmemset()</code>	Set wide character
<code>wcrtomb()</code>	Convert a wide character to a multibyte character
<code>wscat()</code>	Append to wide-character string
<code>wcschr()</code>	Search for wide-character substring
<code>wscmp()</code>	Compare wide-character strings





---

## Chapter 9. Using C and C++ standard streams and redirection

The standard streams are declared in the C header file `stdio.h` or in the C++ header files `iostream.h` or `iostream`. Table 11 shows the C standard streams and the functions that use them. Table 12 on page 64 shows the C++ standard streams and the operators typically used to perform I/O with them.

By default, the standard streams are opened implicitly the first time they are referenced. You do not have to declare them or call their `open()` member functions to open them. For example, with no preceding declaration or `open()` call, the following statement writes the decimal number `n` to the `cout` stream.

```
cout << n << endl;
```

For more detailed information about C++ I/O streaming, see the following:

- *z/OS XL C/C++ Runtime Library Reference* discusses the C I/O stream functions.
- *Standard C++ Library Reference* discusses the Standard C++ I/O stream classes.

Table 11. C standard streams

Stream name	Purpose	Functions that use it
<code>stdin</code>	The input device from which your C program usually retrieves its data.	<code>getchar()</code> <code>getchar_unlocked()</code> <code>gets()</code> <code>gets_unlocked()</code> <code>scanf()</code> <code>scanf_unlocked()</code> <code>vscanf()</code> <code>vscanf_unlocked()</code> <code>wscanf()</code> <code>wscanf_unlocked()</code> <code>vwscanf()</code> <code>vwscanf_unlocked()</code>
<code>stdout</code>	The output device to which your C program normally directs its output.	<code>printf()</code> <code>printf_unlocked()</code> <code>puts()</code> <code>puts_unlocked()</code> <code>putchar()</code> <code>putchar_unlocked()</code> <code>vprintf()</code> <code>vprintf_unlocked()</code> <code>wprintf()</code> <code>wprintf_unlocked()</code> <code>vwprintf()</code> <code>vwprintf_unlocked()</code>
<code>stderr</code>	The output device to which your C program directs its diagnostic messages. z/OS XL C/C++ uses <code>stderr</code> to collect error messages about exceptions that occur.	<code>perror()</code> <code>perror_unlocked()</code>

Table 12. C++ standard streams

Stream name	Purpose	Common usage
cin	The object from which your C++ program usually retrieves its data. In z/OS XL C++, input from cin comes from stdin by default.	>>, the input (extraction) operator
cout	The object to which your C++ program normally directs its output. In z/OS XL C++, output to cout goes to stdout by default.	<<, the output (insertion) operator
cerr	The object to which your C++ program normally directs its diagnostic messages. In z/OS XL C++, output to cerr goes to stderr by default. cerr is unbuffered, so each character is flushed as you write it.	<<, the output (insertion) operator
clog	Another object intended for error messages. In z/OS XL C++, output to clog goes to stderr by default. Unlike cerr, clog is buffered.	<<, the output (insertion) operator

On I/O operations requiring a file pointer, you can use stdin, stdout, or stderr in the same manner as you would any other file pointer.

If you are running with POSIX(ON), standard streams are opened during initialization of the process, before the application receives control. With POSIX(OFF), the default behavior is for the C standard streams to open automatically on first reference. You do not have to call fopen() to open them. For example, if the following statement is specified without a preceding fopen() statement, it writes the decimal number *n* to the stdout stream.

```
printf("%d\n",n);
```

By default, stdin interprets the character sequence /\* as indicating that the end of the file has been reached. See Chapter 13, "Performing terminal I/O operations," on page 191 for more information.

---

## Default open modes

The default open modes for the C standard streams are:

```
stdin  r
stdout w
stderr w
```

Where the streams go depends on what kind of environment you are running under. These are the defaults:

- **Under interactive TSO**, all three standard streams go to the terminal.
- **Under MVS batch, TSO batch, and IMS (batch and interactive):**
  - stdin goes to dd:sysin. If dd:sysin does not exist, all read operations from stdin will fail.
  - stdout goes first to dd:sysprint. If dd:sysprint does not exist, stdout looks for dd:system and then dd:syserr. If neither of these files exists, z/OS XL C/C++ opens a sysout=\* data set and sends the stdout stream to it.
  - stderr will go to the z/OS Language Environment message file. In AMODE 64 applications, stderr goes to dd:sysout.

**Note:** When a standard stream is allocated to a large format sequential data set, the stream will be opened without repositioning (noseek). In this situation, the open is initially attempted with repositioning (seek), fails with an ABEND 213-14 or 213-16, and the stream is then opened without repositioning. For more information on large format sequential data sets, see "Large format sequential data sets" on page 96.

- **Under CICS**, stdout and stderr are assigned to transient data queues, allocated during CICS initialization. The CICS standard streams can be redirected only to or from memory files. You can do this by using freopen().
- **Under z/OS UNIX**, if you are running in one of the z/OS UNIX shells, the shell controls redirection. See *z/OS V2R2.0 UNIX System Services User's Guide* and *z/OS UNIX System Services Command Reference* for information.

You can also redirect the standard streams to other files. See *Redirecting standard streams and sections* following.

---

## Interleaving the standard streams with sync\_with\_stdio()

The sync\_with\_stdio() function allows you to interleave C standard streams with standard streams from either the Standard C++ Library or the USL I/O Stream Class Library. A call to sync\_with\_stdio() does the following:

- cin, cout, cerr, and clog are initialized with stdiobuf objects associated with stdin, stdout, and stderr.
- The flags unitbuf and stdio are set for cout, cerr, and clog.

This ensures that subsequent standard streams may be mixed on a per-character basis. **However, a runtime performance penalty is incurred to ensure this synchronization.** Figure 6 shows an example program and the output that it produces.

```
//  
// Example of interleaving USL I/O with sync_with_stdio()  
//  
// tsyncws.cxx  
#include <stdio.h>  
#include <fstream.h>  
  
int main() {  
    ios::sync_with_stdio();  
    cout << "object: to show that sync_with_stdio() allows interleaving\n    "  
         << "    standard input and output on a per character basis\n" << endl;  
  
    printf( "line 1 ");  
    cout << "rest of line 1\n";  
    cout << "line 2 ";  
    printf( "rest of line 2\n\n");  
  
    char string1[80] = "";  
    char string2[80] = "";  
    char string3[80] = "";  
    char* rc = NULL;  
  
    cout << "type the following 2 lines:\n"  
         << "hello world, here I am\n"  
         << "again\n" << endl;
```

*Interleaving I/O with sync\_with\_stdio() (Part 1 of 2)*

*Figure 6. Interleaving I/O with sync\_with\_stdio()*

```

    cin.get(string1[0]);
    string1[1] = getchar();
    cin.get(string1[2]);

    cout << "\nstring1[0] is \' " << string1[0] <<
"\'\n"
    << "string1[1] is \' " << string1[1] <<
"\'\n"
    << "string1[2] is \' " << string1[2] <<
"\'\n" << endl;

    cin >> &string1[3];
    rc = gets(string2); // note: reads to end of line, so
    cin >> string3;    // this line waits for more input

    cout << "\nstring1 is \'" << string1 << "\'\n"
    << "string2 is \'" << string2 << "\'\n"
    << "string3 is \'" << string3 << "\'\n" <<
flush;
}

// sample output (with user input shown underlined):
//
// object: to show that sync_with_stdio() allows interleaving
//         standard input and output on a per character basis
//
// line 1 rest of line 1
// line 2 rest of line 2
//
// type the following 2 lines:
// hello world, here I am
// again
//
// hello world, here I am
//
// string1[0] is 'h'
// string1[1] is 'e'
// string1[2] is 'l'
//
// again
//
// string1 is "hello"
// string2 is "world, here I am"
// string3 is "again"

```

*Interleaving I/O with sync\_with\_stdio() (Part 2 of 2)*

---

## Interleaving the standard streams without sync\_with\_stdio()

Output can be interleaved without sync\_with\_stdio(), since the C++ standard streams are based on z/OS XL C I/O. That is, cout can be interleaved with stdout, and clog can be interleaved with stderr. This is done by explicitly flushing cout or clog before calling the z/OS XL C output function. Results of attempting to interleave these streams without explicitly flushing, are undefined. Output to cerr doesn't have to be explicitly flushed, since cerr is unit-buffered.

Input to cin may be interleaved with input to stdin, without sync\_with\_stdio(), on a line-by-line basis. Results of attempting to interleave on a per-character basis are undefined. Figure 7 on page 67 shows an example program and the output it produces.

```

// Example of interleaving I/O without sync_with_stdio()
//
// tsyncwos.cxx
#include <stdio.h>
#include <fstream.h>

int main() {
    cout << "object: to illustrate interleaving input and output\n"
         "    without sync_with_stdio()\n" << endl;

    printf( "interleaving output ");
    cout << "works with an (end of line 1)  \n" << flush;
    cout << "explicit flush of cout      " << flush;
    printf( "(end of line 2)\n\n");

    char  string1[80] = "";
    char  string2[80] = "";
    char  string3[80] = "";
    char* rc = NULL;

    cout << "type the following 3 lines:\n"
         "interleaving input\n"
         "on a per-line basis\n"
         "is supported\n" << endl;

    cin.getline(string1, 80);
    rc = gets(string2);
    cin.getline(string3, 80);

    cout << "\nstring1 is \"" << string1 << "\"\n"
         << "string2 is \"" << string2 << "\"\n"
         << "string3 is \"" << string3 << "\"\n" << endl;
        // The endl manipulator inserts a newline
        // character and calls flush().

    char  char1 = '\0';
    char  char2 = '\0';
    char  char3 = '\0';

    cout << "type the following 2 lines:\n"
         "results of interleaving input on a per-\n"
         "character basis are not defined\n" << endl;

    cin >> char1;
    char2 = (char) getchar();
    cin >> char3;

    cout << "\nchar1  is \' " << char1 << "\'\n"
         << "char2   is \' " << char2 << "\'\n"
         << "char3   is \' " << char3 << "\'\n" << flush;
}

```

*Interleaving I/O without sync\_with\_stdio() (Part 1 of 2)*

*Figure 7. Interleaving I/O without sync\_with\_stdio()*

```

// sample output (with user input shown underlined):
//
// object: to illustrate interleaving input and output
//         without sync_with_stdio()
//
// interleaving output works with an (end of line 1)
// explicit flush of cout           (end of line 2)
//
// type the following 3 lines:
// interleaving input
// on a per-line basis
// is supported
//
// interleaving-input
// on a per-line basis
// is supported
//
// string1 is "interleaving input"
// string2 is "on a per-line basis"
// string3 is "is supported"
//
// type the following 2 lines:
// results of interleaving input on a per-
// character basis are not defined
//
// results of interleaving input on a per-
// character basis are not defined
//
// char1  is 'r'
// char2  is 'c'
// char3  is 'e'

```

*Interleaving I/O without sync\_with\_stdio() (Part 2 of 2)*

---

## Redirecting standard streams

This section describes redirection of standard streams:

- From the command line
- By assignment
- With freopen()
- With the MSGFILE runtime option

Note that, C++ standard streams are implemented in terms of C standard streams. Therefore, cin, cout, cerr, and clog are implicitly redirected when the corresponding C standard streams are redirected. These streams can be redirected by assignment, as described in “Assigning the standard streams” on page 70. If freopen() is applied to a C standard stream, creating a binary stream or one with type=record or type=blocked, then behavior of the related stream is undefined.

---

## Redirecting streams from the command line

To redirect a standard stream to a file from the command line, invoke your program by entering the following:

1. Program name
2. Any parameters your program requires (these may be specified before and after the redirection)
3. A redirection symbol followed by the name of the file that is to be used in place of the standard stream

**Note:** If you specify a redirection in a `system()` call, after `system()` returns, the streams are redirected back to those at the time of the `system()` call.

## Using the redirection symbols

The following table lists the redirection symbols supported by z/OS XL C/C++ (when not running under one of the z/OS UNIX shells) for redirection of C standard streams from the command line or from a `system()` call. 0, 1, and 2 represent `stdin`, `stdout`, and `stderr`, respectively.

Table 13. z/OS XL C/C++ Redirection symbols

Symbol	Description
<code>&lt;fn</code>	associates the file specified as <i>fn</i> with <code>stdin</code> ; reopens <i>fn</i> in mode <code>r</code> .
<code>0&lt;fn</code>	associates the file specified as <i>fn</i> with <code>stdin</code> ; reopens <i>fn</i> in mode <code>r</code> .
<code>&gt;fn</code>	associates the file specified as <i>fn</i> with <code>stdout</code> ; reopens <i>fn</i> in mode <code>w</code> .
<code>1&gt;fn</code>	associates the file specified as <i>fn</i> with <code>stdout</code> ; reopens <i>fn</i> in mode <code>w</code> .
<code>&gt;&gt;fn</code>	associates the file specified as <i>fn</i> with <code>stdout</code> ; reopens <i>fn</i> in mode <code>a</code> .
<code>2&gt;fn</code>	associates the file specified as <i>fn</i> with <code>stderr</code> ; reopens <i>fn</i> in mode <code>w</code> .
<code>2&gt;&gt;fn</code>	associates the file specified as <i>fn</i> with <code>stderr</code> ; reopens <i>fn</i> in mode <code>a</code> .
<code>2&gt;&amp;1</code>	associate <code>stderr</code> with <code>stdout</code> ; same file and mode.
<code>1&gt;&amp;2</code>	associate <code>stdout</code> with <code>stderr</code> ; same file and mode.

### Notes:

1. If you use the `NOREDİR` option on a `#pragma runopts` directive, or the `NOREDİR` compile-time option, you cannot redirect standard streams on the command line using the preceding list of symbols.
2. If you want to pass one of the redirection symbols as an argument, you can enclose it in double quotation marks. For example, the following passes the string "here are the args including a <" to `prog` and redirects `stdout` to `redir1` output `a`.

```
prog "here are args including a <" >"redir1 output a"
```
3. TSO (batch and online) and MVS batch support command line arguments. CICS and IMS do not.
4. When two options specifying redirection conflict with each other, or when you redirect a standard stream more than once, the redirection fails. If you do the latter, you will get an abend. For example, if you specify

```
2>&1
```

and then

```
1>&2
```

z/OS XL C/C++ uses the first redirection and ignores any subsequent ones. If you specify

```
>a.out
```

and then

```
1>&2
```

the redirection fails and the program abends.
5. A failed attempt to redirect a standard stream causes your program to fail in initialization.
6. The C standard streams can be redirected to large format sequential data sets. If this occurs, the stream will be reopened without repositioning (`noseek`). In this



situation, the reopen is initially attempted with repositioning (seek), fails with an ABEND 213-14 or 213-16, and the stream is then reopened without repositioning.

---

## Assigning the standard streams

This method of redirecting streams is known as *direct* assignment. You can redirect a C standard stream by assigning a valid file pointer to it, as follows:

```
FILE *stream;
stream = fopen("new.file", "w+");
stdout = stream;
```

You must ensure that the streams are appropriate; for example, do not assign a stream opened for `w` to `stdin`. Doing so would cause a function such as `getchar()` called for the stream to fail, because `getchar()` expects a stream to be opened for read access.

Similarly, you can redirect a standard stream under C++ by assignment:

```
ofstream myfile("myfile.data");
cout = myfile;
```

Again, you must ensure that the assigned stream is appropriate; for example, do not assign an `fstream` opened for `ios::out` only to `cin`. This will cause a subsequent read operation to fail.

---

## Using the `freopen()` library function

You can use the `freopen()` C library function to redirect C standard streams in all environments.

---

## Redirecting streams with the MSGFILE option

**Restriction:** This section does not apply to AMODE 64.

You can redirect `stderr` by specifying a `ddname` on the `MSGFILE` runtime option and not redirecting `stderr` elsewhere (such as on the command line). The default `ddname` for the z/OS Language Environment `MSGFILE` is `SYSOUT`. See *z/OS Language Environment Programming Guide* for more information on `MSGFILE`.

## MSGFILE considerations

z/OS XL C/C++ makes a distinction between types of error output according to whether the output is directed to the `MSGFILE`, to `stderr`, or to `stdout`:

Table 14. Output destinations under z/OS XL C/C++

Destination of Output	Type of Message	Produced by	Default Destination
MSGFILE output	z/OS Language Environment messages (CEExxxx)	z/OS Language Environment conditions	MSGFILE ddname
	z/OS XL C/C++ language messages (EDCxxxx)	z/OS XL C/C++ unhandled conditions	MSGFILE ddname

Table 14. Output destinations under z/OS XL C/C++ (continued)

Destination of Output	Type of Message	Produced by	Default Destination
stderr messages	perror() messages (EDCxxxx)	Issued by a call, for example, to: perror()	MSGFILE ddname (see note 1)
	User output sent explicitly to stderr	Issued by a call to fprintf()	MSGFILE ddname
stdout messages	User output sent explicitly to stdout	Issued by a call, for example, to: printf()	stdout (see note 2)

**Notes:**

1. When you are using one of the z/OS UNIX shells, stderr will go to file descriptor 2, which is typically the terminal. See Chapter 16, "Language Environment Message file operations," on page 217 for more information about z/OS Language Environment message files.
2. When you are using one of the z/OS UNIX shells, stdout will go to file descriptor 1, which is typically the terminal.

All stderr output is by default sent to the MSGFILE destination, while stdout output is sent to its own destination. When stderr is redirected to stdout, both share the stdout destination. When stdout is redirected to stderr, both share the stderr destination.

If you specified one of the DDs used in the stdout open search order as the DD for the MSGFILE option, then that DD will be ignored in the stdout open search.

Table 15 describes the destination of output to stderr and stdout after redirection has occurred. Whenever stdout and stderr share a common destination, the output is interleaved. The default case is the one where stdout and stderr have not been redirected.

Table 15. z/OS XL C/C++ Interleaved output

	stderr not redirected	stderr redirected to destination other than stdout	stderr redirected to stdout
stdout not redirected	stdout to itself stderr to MSGFILE	stdout to itself stderr to its other destination	Both to stdout
stdout redirected to destination other than stderr	stdout to its other destination stderr to MSGFILE	stdout to its other destination stderr to its other destination	Both to the new stdout destination
stdout redirected to stderr	Both to MSGFILE	Both to the new stderr destination	stdout to stderr stderr to stdout

z/OS XL C/C++ routes error output as follows:

- MSGFILE output
  - z/OS Language Environment messages (messages prefixed with CEE)
  - Language messages (messages prefixed with EDC)
- stderr output
  - perror messages (messages prefixed with EDC and issued by a call to perror())
  - Output explicitly sent to stderr (for example, by a call to fprintf())

By default, z/OS XL C/C++ sends all stderr output to the MSGFILE destination and stdout output to its own destination. You can change this by using z/OS XL C/C++ redirection, which enables you to redirect stdout and stderr to a ddname, file name, or each other. Unless you have redirected stderr, it always uses the MSGFILE destination. When you redirect stderr to stdout, stderr and stdout share the stdout destination. When you redirect stdout to stderr, they share the stderr destination.

---

## Redirecting streams under z/OS

This section describes how to redirect C standard streams under MVS batch and under TSO.

**Restrictions:** The following restrictions apply to AMODE 64 applications:

- IMS and CICS environments are not supported in AMODE 64 applications
- The Language Environment Message File (MSGFILE) is not supported in AMODE 64 applications
- The stderr stream goes to the ddname SYSOUT in AMODE 64 applications

### Under MVS batch

You can redirect standard streams in the following ways:

- From the `freopen()` library function call
- On the PARM parameter of the EXEC used to invoke your C or C++ program
- Using DD statements

Because the topic of JCL statements goes beyond the scope of this book, only simple examples will be shown here.

### Using the PARM parameter of the EXEC statement

The following example shows an excerpt taken from a job stream. It demonstrates both the redirection of stdout using the PARM parameter of the EXEC statement, and the way to redirect to a fully qualified data set. You can use the redirection symbols described in Table 13 on page 69.

Suppose you have a program called BATCHPGM, with 1 required parameter 'DEBUG'. The output from BATCHPGM is to be directed to a sequential data set called 'MAINT.LOG.LISTING'. You can use the following JCL statements:

```
//JOBname      JOB...
//STEP01      EXEC PGM=BATCHPGM,PARM='DEBUG >'MAINT.LOG.LISTING''
:
```

The following JCL redirects output to an unqualified data set using the same program name, parameter and output data set as the example above:

```
//STEP01      EXEC PGM=BATCHPGM,PARM='DEBUG >LOG.LISTING'
```

If your user ID was TSOU812, stdout would be sent to TSOU812.LOG.LISTING.

### Using DD statements

When you use DD statements to redirect standard streams, the standard streams will be associated with ddnames as follows:

- `stdin` will be associated with the `SYSIN` ddname. If `SYSIN` is not defined, no characters can be read in from `stdin`.
- `stdout` will be associated with the `SYSPRINT` ddname. If `SYSPRINT` is not defined, the C library will try to associate `stdout` with `SYSTEM`, and if `SYSTEM` is also not defined, the C library will try to associate `stdout` with `SYSERR`. If any of the above DD statements are used as the `MSGFILE` DD, then that DD statement will not be considered for use as the `stdout` DD.  
**Restriction:** The reference to the `MSGFILE` does not apply to AMODE 64 applications.
- `stderr` will be associated with the `MSGFILE`, which defaults to `SYSOUT`. See *z/OS Language Environment Programming Guide* for more information on `MSGFILE`.  
**Restriction:** The reference to the `MSGFILE` does not apply to AMODE 64 applications.
- If you are running with the runtime option `POSIX(ON)`, you can redirect standard streams with ddnames only for MVS data sets, not for UNIX file system files.
- If the ddname for `stdout` is not allocated to a device or data set, it is dynamically allocated to the terminal in an interactive environment or to `SYSOUT=*` in an MVS batch environment.

Table 16 summarizes the association of streams with ddnames:

Table 16. Association of standard streams with ddnames

Standard stream	ddname	Alternate ddname
<code>stdin</code>	<code>SYSIN</code>	none
<code>stdout</code>	<code>SYSPRINT</code>	<code>SYSTEM</code> , <code>SYSERR</code>
<code>stderr</code>	DD associated with <code>MSGFILE</code> . For AMODE 64 applications <code>stderr</code> is <code>SYSOUT</code> , and there is no alternate ddname.	None

Figure 8 shows excerpt from an MVS example job stream that demonstrates the redirection of the three standard streams by using ddnames. In the example, your program name is `MONITOR` and the input to `MONITOR` is to be retrieved from a sequential data set called `'SAFETY.CHEM.LIST'`. The output of `MONITOR` is to be directed to a partitioned data set member called `'YEAREND.ACTION(CHEM)'`, and any errors generated by `MONITOR` are to be written to a sequential data set called `'YEAREND.MONITOR.ERRLIST'`. To redirect the standard streams using DD statements, you could use the JCL statements shown in Figure 8.

```

//JOBname      JOB...
//STEP01      EXEC PGM=MONITOR,PARM='MSGFILE(SYSERR)'/
:
//SYSIN       DD DSN=SAFETY.CHEM.LIST,DISP=OLD
//SYSERR      DD DSN=YEAREND.MONITOR.ERRLIST,DISP=MOD
//SYSPRINT    DD DSN=YEAREND.ACTION(CHEM),DISP=OLD
:

```

Figure 8. MVS example of redirecting three standard streams by ddnames

Figure 9 on page 74 shows how to get `stdout` and `stderr` to share the same file where: the program name is `HOCKEY` and the input to `HOCKEY` is to be retrieved from a sequential data set called `'HOCKEY.PLAYER.LIST'`. The output of `HOCKEY` is to be directed to a sequential data set called `'HOCKEY.OUTPUT'` and any errors generated by `HOCKEY` are also to be written to the sequential data set `'HOCKEY.OUTPUT'`. You

could use the JCL statements shown in Figure 9.

---

```
//JOBname      JOB...
//STEP01      EXEC PGM=HOCKEY,PARM='/ 2>&1'
//SYSIN       DD DSN=HOCKEY.PLAYER.LIST,DISP=SHR
//SYSPRINT    DD DSN=HOCKEY.OUTPUT,DISP=(OLD),DCB=...
```

---

Figure 9. Example of using stdout and stderr to share the same file

stderr shares stdout because of the 2>&1 redirection statement.

If you want to redirect to a UNIX file system file, you can modify the above examples to use the PATH and PATHOPT options described in “DDnames” on page 36.

## Under TSO

You can redirect standard streams in the following ways:

- From the freopen() library function call
- From the command line
- Using the parameter list in a CALL command

### From the command line

The following example illustrates the redirection of stdin under TSO. The program in this example is called BUILD and it has 2 required parameters, 'PLAN' and 'JOHNSTON'. The input to BUILD is to be retrieved from a partitioned data set member called 'CONDO(SPRING)'. To redirect stdin in this example under TSO you can use the following command:

```
BUILD PLAN JOHNSTON <'CONDO(SPRING)'
```

#### Notes:

1. If the data set name is not enclosed in quotation marks, your user prefix will be appended to the data set name specified.
2. If you specify a redirection in a system() call, after system() returns, the streams are redirected back to those at the time of the system() call.

### Using the parameter list in a CALL command

You can also redirect the output to a file with a ddname in TSO by specifying the output file in the parameter list like the following:

```
CALL 'PREFIX.PROGRAM' '>DD:OUTFILE'
```

The ddname can be created by an ALLOCATE command.

## Under IMS

Under IMS online and batch, you can redirect the C standard streams in any of the following ways:

- with direct assignment
- with the freopen() function
- with ddnames

For details on ddnames, see “Using DD statements” on page 72.

## Under CICS

There are several ways to redirect C standard streams under CICS:

- You can assign a memory file to the stream (for example, `stdout=myfile`).
- You can use `freopen()` to open a standard stream as a memory file.
- You can use CICS facilities to direct where the stream output goes.

If you assign a file pointer to a stream or use `freopen()` on it, you will not be able to use C functions to direct the information outside or elsewhere in the CICS environment. Once access to a CICS transient data queue has been removed, either by a call to `freopen()` or `fclose()`, or by the assignment of another file pointer to the stream, z/OS XL C/C++ does not provide a way to regain access. Once C functions have lost access to the transient data queues, you must use the CICS-provided facilities to regain it.

CICS provides a facility that enables you to direct where a given transient data queue, the default standard stream implementation, will go, but you must configure this facility before a CICS cold start.

---

## Passing C and C++ standard streams across a `system()` call

A `system()` call occurs when one z/OS XL C/C++ program calls another z/OS XL C/C++ program by using the ANSI `system()` function, which z/OS XL C/C++ uses if you are not running with `POSIX(ON)`. Standard streams are inherited across calls to the ANSI `system()` function. With a `POSIX` `system()` function, file descriptors 0, 1, and 2 will be mapped to standard streams `stdin`, `stdout` and `stderr` in the child process. The behavior of these streams is similar to binary streams called with the ANSI `system()` function.

Inheritance includes any redirection of the stream as well as the open mode of the stream. For example, if program A reopens `stdout` as "A.B" for "wb" and then calls program B, program B inherits the definition of `stdout`. If program B reopens `stdout` as "C.D" for "ab" and then uses `system()` to call program C, program C inherits `stdout` opened to "C.D" for append. Once control returns to the calling program, the definitions of the standard streams from the time of the `system()` call are restored. For example, when program B finally returns control to program A, `stdout` is restored to "A.B" opened for "wb".

The file position and the amount of data that is visible in the called and calling programs depend on whether the standard streams are opened for binary, text, record I/O, or blocked I/O.

The behavior of the C standard streams across a `system()` call indicates the behavior of all standard streams since they are implemented in terms of the C standard streams.

## Passing binary streams

If the standard stream being passed across a `system()` call is opened in binary mode, any reads or writes issued in the called program occur at the next byte in the file. On return, the position of the file is wherever the called program is positioned. This includes any possible repositions made by the called program if the file is enabled for positioning. Because output to binary files is done byte by byte, all bytes are written to `stdout` and `stderr` in the order they are written. This is shown in the following example:

```

printf("123");
printf("456");
system("CHILD");  -----> int main(void) { putc('7',stdout);}
printf("89");

```

The output from this example is: 123456789

Memory files are always opened in binary mode, even if you specify text. Any standard streams redirected to memory files and passed across `system()` calls will be treated as binary files. UNIX file system files are also treated as binary files, because they do not contain any real record boundaries. Memory files are not passed across calls to the POSIX `system()` function.

If `freopen()` is applied to a C standard stream, thereby creating a binary stream, then the results of I/O to the associated standard stream across a `system()` call are undefined.

## Passing text streams

If the C standard stream being passed across a `system()` call is opened in text mode (the default), the file position in the called program is placed at the next record boundary, if it is not already at the start of a record. Any data in the current record that is unread is skipped. Figure 10 show an example.

---

INPUT FILE	ROOT C PROGRAM	CHILD PROGRAM
-----	int main() {	int main() {
abcdefghijklm	char c[4];	char d[2];
nopqrstuvwxyz	c[0] = getchar();	d[0] = getchar();
0123456789ABC	c[1] = getchar();	d[1] = getchar();
DEFGHIJKLMNO	system("CHILD");	printf("%.2s\n",
	c[2] = getchar();	d);
	c[3] = getchar();	}
	printf("%.4s\n",c);	
	}	

OUTPUT

```

-----
no      ---> from the child
ab01    ---> from root

```

---

*Figure 10. Example of passing text streams*

When you write to a spanned file, the file position moves to the beginning of the next record, if that record exists. If not, the position moves to the end of the incomplete record.

For non-spanned standard streams opened for output, if the caller has created a text record missing an ending control character, the last record is hidden from the called program. The called program can append new data if the stream is open in append mode. Any appends made by the called program will be after the last record that was complete at the time of the `system()` call.

When the called program terminates, it completes any new unfinished text record with a new-line; the addition of the new-line does not move the file position. Once any incomplete record is completed, the file position moves to the next record boundary, if it is not already on a record boundary or at EOF.

When control returns to the original caller, any incomplete record hidden at the time of the `system()` call is restored to the end of the file. If the called program is



at EOF when it is terminated and the caller was within an incomplete record at the time of the `system()` call, the position upon return is restored to the original record offset at the time of the `system()` call. This position is usually the end of the incomplete record. Generally, if the caller is writing to a standard stream and does not complete the last record before it calls `system()`, writes continue to add to the last record when control returns to the caller. For example:

```
printf("test");
printf("abc");
system("hello");  -----> int main(void) { printf("hello world\n");}
printf("def\n");
```

The output from this example is as follows:

```
test
hello world
abcdef
```

If `stdout` had been opened for "w+" in this example, and a reposition had been made to the character 'b' before the `system()` call, upon return, the incomplete record "abc" would have been restored and the position would have been at the 'b'. The subsequent write of `def` would have performed an update to give `test hello world adef`.

## C++ standard streams considerations

The following sections are considerations for C++ standard streams.

**Output with `sync_with_stdio()`:** When a standard output stream is open in text mode (the default), and `sync_with_stdio()` has been called, the output across a `system()` call behaves the same as a C standard stream:

- If the parent program writes a newline character, the line will be flushed before the child program is invoked;
- Otherwise, the output from the parent will be held in a buffer until the child returns.

**Output without `sync_with_stdio()`:** When a standard output stream is open in text mode, and `sync_with_stdio()` has not been called, the behavior is as follows:

- If the parent program writes a newline character, and explicitly flushes it, the line will be written out before the child program is invoked;
- Otherwise, the behavior is undefined.

**Input with `sync_with_stdio()`:** When `cin` is open in text mode (the default), and `sync_with_stdio()` has been called, the input across a `system()` call behaves the same as `stdin`:

- The child program begins reading at the next record boundary, that is, unread data in the current record in the parent is hidden.
- When the child program returns, the parent program begins reading at the next record boundary, that is, unread data in the current record in the child is lost.

**Input without `sync_with_stdio()`:** When `cin` is open in text mode, and `sync_with_stdio()` has not been called, the behavior is as follows:

- The parent program must either not read from `cin` before calling the child, or must read to the end of a complete record.
- The child program begins reading at the next record boundary, that is, unread data in the current record in the parent is hidden.



- When the child program returns, the parent program begins reading at the next record boundary, that is, unread data in the current record in the child is lost.
- If the parent program read only part of a record before calling the child, the behavior upon returning from the child is undefined.

## Passing record I/O streams

For record I/O, all reads and writes made by the called program occur at the next record boundary. Because complete records are always read and written, there is no change in the file position across a `system()` call boundary.

In the example shown in Figure 11, `stdout` is a variable-length record I/O file.

---

```

fwrite("test",1,4,stdout);
fwrite("abc",1,3,stdout);
system("hello"); ----->
fwrite("def",1,3,stdout);
                                int main(void) {
                                    fwrite("hello world",1,11,stdout)
                                }

```

---

*Figure 11. Example of passing record I/O streams*

The output from this code fragment is as follows:

```

test
abc
hello world
def

```

If `freopen()` is applied to a C standard stream, creating a stream with `type=record`, then behavior of the associated I/O stream is undefined across a `system()` call.

## Passing blocked I/O streams

For blocked I/O, all reads and writes made by the called program occur at the next block boundary. Because complete blocks are always read and written, there is no change in the file position across a `system()` call boundary.

If `freopen()` is applied to a C standard stream, creating a stream with `type=blocked`, then behavior of the associated I/O stream is undefined across a `system()` call.

---

## Using global standard streams

**Restriction:** This section does not apply to AMODE 64.

In the default inheritance model, the behavior of C standard streams is such that a child `main()` function cannot affect the standard streams of the parent. The child can use the parent's definition or redirect a standard stream to a new location, but when control returns to the parent, the standard stream reverts back to the definition of the parent. In the global model, the C standard streams, `stdin`, `stdout`, and `stderr`, can be redirected to a different location while running in a child `main()` function and have that redirection stay in effect when control returns to the parent. You can use the `_EDC_GLOBAL_STREAMS` environment variable to set standard stream behavior to the global model. For more information, see “`_EDC_GLOBAL_STREAMS`” on page 493.

Table 17 highlights the standard stream behavior differences between the default inheritance model and the global model.

Table 17. Standard stream behavior differences

Behavior	Default Inheritance Model	Global Model
POSIX(OFF)	Standard streams are opened automatically on first reference.	(Same)
POSIX(ON)	Standard streams are opened during initialization of the process, before the application receives control.	Not supported.
default open modes	As described in “Default open modes” on page 64.	(Same)
default locations	As described in this chapter.	(Same)
command line redirection	Changes the location for the main being called and subsequent child programs.	Changes the location for the entire C environment.
direct assignment	Affects the current main and subsequent child programs.	Affects the current main only. This definition is not passed on to a subsequent child program. The child gets the current global definition, if there is one defined.
freopen()	Changes location for the main from which it is called and affects any subsequent child programs.	Changes location for the entire C environment.
MSGFILE() runtime option	Redirects stderr for the main being invoked and affects any subsequent child programs. When control returns to a parent program, stderr reverts back to the definition of the parent. If stderr is also redirected on the command line, that redirection takes precedence.	(Same)
fclose()	Closes the standard stream in current main only.	Closes the standard stream for the entire C environment. The standard stream cannot be global anymore. Only direct assignment can be used to use the standard stream, and that would only be for the main in which it is assigned.
file position and visible data	As currently described in this chapter.	File position and visible data across mains are as if there were only one main. No special processing occurs during the ANSI system() call. The standard streams are left untouched. When either entering or returning from a child program, reading or writing to the standard streams begin where previously left off,
C++ I/O Stream	cin defaults to stdin cout defaults to stdout cerr defaults to stderr (unbuffered) clog defaults to stderr (buffered)	(Same)

**Notes:**

- The following environments do not allow global standard stream behavior as an option:
  - POSIX(ON)

- CICS
  - SPC
  - AMODE 64
2. You must identify the behavior of the standard streams to the C runtime library before initialization of the first C main in the environment. The default behavior uses the inheritance model. Once you set the standard stream behavior, it cannot be changed. Attempts to change the behavior after the first C main has been initialized are ignored.
  3. The value of the environment variable, when queried, does not necessarily reflect the standard stream behavior being used. This is because the value of the environment variable can be changed after the standard stream behavior has been set.
  4. The behaviors described in Table 17 on page 79 only apply to the standard streams that use the global behavior.

## Command line redirection

In the C standard stream global model, command line redirection of the standard streams is supported, but has much different behavior than the C standard stream inheritance model.

The most important difference is that when redirection is done at `system()` call time, the redirection takes effect for the entire C environment. When the child program terminates, the standard stream definitions do not revert back to what they were before the `system()` call.

Redirection of any of the standard streams, except when `stderr` is redirected to `stdout` or vice versa, causes the standard stream to be flushed. This is because an `freopen()` is done under the covers, which first closes the stream before reopening it. Since the standard stream is global, the close causes the flush.

Redirecting `stderr` to `stdout`, or `stdout` to `stderr`, does not flush the redirected stream. Any data in the buffer remains there until the stream is redirected again, to something other than `stdout` or `stderr`. Only then is the buffer flushed.

Consider the following example programs, `PARENT.C` and `CHILD.C`, shown in Figure 12 on page 81.

---

```

PARENT.C

#include <stdio.h>
#include <stdlib.h>
main() {
    int rc;
    printf("line 1\n");
    printf("line 2");
    fprintf(stderr,"line 3\n");
    fprintf(stderr,"line 4");
    rc=system("PGM=CHILD,PARM='/ >stdout.file 2>&1;")
    printf("line 5\n");
    fprintf(stderr,"line 6\n");
}

CHILD.C

#include <stdio.h>
main() {
    printf("line 7\n");
    fprintf(stderr,"line 8\n");
    stderr = freopen("stderr.file","w",stderr);
    printf("line 9\n");
    fprintf(stderr,"line 10\n");
}

```

---

*Figure 12. Example of command line redirection*

When run from TSO terminal using the command `parent ENVAR(_EDC_GLOBAL_STREAMS=7)/`, the output will be as follows:

(terminal)	stdout.file	stderr.file
line 1	line 7	line 10
line 3	line 8	line 6
line 2	line 9	
line 4	line 5	

**Attention:** If the stdout or stderr stream has data in its buffer and it is redirected to stderr or stdout, then the data is lost if stdout or stderr is not redirected again.

**Note:** If either stdout or stderr is using global behavior, but not both, then any redirection of stdout or stderr to stderr or stdout is ignored.

## Direct assignment

You can directly assign the C standard streams in any main program. This assignment does not have any effect on the global standard stream. No flush is done and the new definition is not passed on to a child program nor back to a parent program. Once you directly assign a standard stream, there is no way to re-associate it with the global standard stream.

## freopen()

When you use `freopen()` to redirect a standard stream, the stream is closed, causing a flush, and then redirected. The new definition affects all C mains currently using the global stream.

## MSGFILE() runtime option

The `MSGFILE()` runtime option redirects the stderr stream similar to command line redirection. However, this redirection is controlled by the Common Execution Library and does not apply to all C mains in the environment. When control returns to a parent program, stderr reverts back to the definition of the parent.

## **fclose()**

When a global standard stream is closed, only direct assignment can be used to begin using the standard stream again. That use would only be for the main performing the direct assignment. There is no way to get back global behavior for the standard stream that was closed.

## **File position and visible data**

The file position and amount of visible data in the called and calling program is as if there is only one program. There is no data hidden from a called program. A child program continues where the parent program left off. This is true for all types of I/O: binary, text, and record.

## **C++ I/O stream library**

Since `cin`, `cout`, `cerr` and `clog` are initially based on `stdin`, `stdout` and `stderr`, they continue to be in the global model. For example, if `stdout` is redirected using `freopen()` in a child program, then both `stdout` and `cout` retain that redirection when control returns to the parent.

---

## Chapter 10. Performing OS I/O operations

This topic describes using OS I/O, which includes support for the following:

- Regular sequential DASD (including striped data sets)
- Partitioned DASD (PDS and PDSE)
- Tapes
- SYSOUT
- Printers
- In-stream JCL

### Notes:

1. z/OS XL C/C++ does not support BDAM, ISAM, or non-VSAM keyed data sets. Attempting to open a non-VSAM keyed data set for read or append fails; attempting to open an existing non-VSAM keyed data set for write results in unpredictable results.
2. z/OS XL C/C++ provides complete read and write support for large format sequential data sets when seek is requested (not specifying the noseek keyword) and when noseek is requested and honored.
3. z/OS XL C/C++ provides support for extended format sequential data sets in the extended addressing space on extended address volumes (EAVs).
4. z/OS XL C/C++ supports opening DDNAMEs that have been dynamically allocated with the XTIO, UCB nocapture, and DSAB-above-the-line options specified in the SVC99 parameters (S99TIOEX, S99ACUCB, S99DSABA flags).

OS I/O supports text, binary, record I/O, and blocked I/O, in record formats: fixed (F), variable (V), and undefined (U). For information about using wide-character I/O with z/OS XL C/C++, see Chapter 8, “z/OS XL C Support for the double-byte character set,” on page 53.

This topic describes C I/O stream functions as they can be used within C++ programs. If you want to use the C++ I/O stream classes instead, see Chapter 4, “Using the Standard C++ Library I/O Stream Classes,” on page 23 for general information. For more detailed information, see *Standard C++ Library Reference*, which discusses the Standard C++ I/O stream classes

---

## Opening files

To open an OS file, you can use the Standard C functions `fopen()` or `freopen()`. These are described in general terms in *z/OS XL C/C++ Runtime Library Reference*. Details about them specific to all z/OS XL C/C++ I/O are discussed in the “Opening Files” section. This section describes considerations for using `fopen()` and `freopen()` with OS files.

### Using `fopen()` or `freopen()`

When you open a file using `fopen()` or `freopen()`, you must specify the filename (a data set name) or a ddname. **Restriction:** It is not possible to open a file for writing if there is already an open file with the same data set name on a different volume

## Using a data set name

Files are opened with a call to `fopen()` or `freopen()` in the format `fopen("filename", "mode")`. The following diagram shows the syntax for the *filename* argument on your `fopen()` or `freopen()` call:

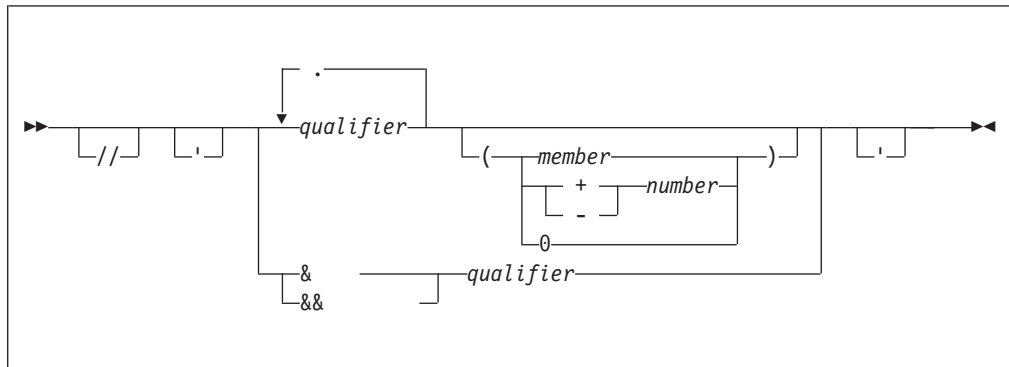

**Note:** The single quotation marks in the *filename* syntax diagram must be matched; if you use one, you must use the other.

A sample construct is shown below:

```
'qualifier1.qualifier2(member)'
```

// Specifying these slashes indicates that the filename refers to a non-POSIX file or data set.

### *qualifier*

Each qualifier is a 1- to 8-character name. These characters may be alphanumeric, national (\$, #, @), or the hyphen. The first character should be either alphabetic or national. Do not use hyphens in names for RACF-protected data sets.

You can join qualifiers with periods. The maximum length of a data set name is as follows:

- Generally, 44 characters, including periods.
- For a generation data group, 35 characters, including periods.

These numbers do not include a member name or GDG number and accompanying parentheses.

Specifying one or two ampersands before a single qualifier opens a temporary data set. Multiple qualifiers are not valid after ampersands, because the system generates additional qualifiers. Opening two temporary data sets with the same name creates two distinct files. If you open a second temporary data set using the same name as the first, you get a distinct data set. For example, the following statements open two temporary data sets:

```
fp = fopen("//&&myfile", "wb+");
fp2 = fopen("//&&myfile", "wb+");
```

You cannot fully qualify a temporary data set name. The file is created at open time and is empty. When you close a temporary data set, the system removes it.

(*member*)

If you specify a *member*, the data set you are opening must be a PDS or a PDSE. For more information about PDSs and PDSEs, see “Regular and extended partitioned data sets” on page 89. For members, the member name (including trailing blanks) can be up to 8 characters long. A member name cannot begin with leading blanks. The characters in a member name may be alphanumeric, national (\$, #, @), the hyphen, or the character X'CO'. The first character should be either alphabetic or national.

+*number*

-*number*

- 0 You specify a Generation Data Group (GDG) by using a plus (+) or minus (-) to precede the version number, or by using a 0. For more information about GDGs, see “Generation data group I/O” on page 87.

The Resource Access Control Facility (RACF®) expects the data set name to have a high-level qualifier that is defined to RACF. RACF uses the entire data set name when it protects a tape data set.

When you enclose a name in single quotation marks, the name is *fully qualified*. The file opened is the one specified by the name inside the quotation marks. If the name is not fully qualified, z/OS XL C/C++ does one of the following:

- If your system does not use RACF, z/OS XL C/C++ does not add a high-level qualifier to the name you specified.
- If you are running under TSO (batch or interactive), z/OS XL C/C++ appends the TSO user prefix to the front of the name. For example, the statement `fopen("a.b", "w");` opens a data set `tsoid.A.B`, where `tsoid` is the user prefix. If the name is fully qualified, z/OS XL C/C++ does not append a user prefix. You can set the user prefix by using the TSO PROFILE command with the PREFIX parameter.
- If you are running under z/OS batch or IMS (batch or online), z/OS XL C/C++ appends the RACF user ID to the front of the name.

If you want your code to be portable between the VM/CMS and z/OS systems and between memory files and disk files, use a name of the format `name1.name2`, where `name1` and `name2` are up to 8 characters and are delimited by a period, or use a ddname. You can also add a member name.

For example, the following piece of code can run under Language Environment for VM and z/OS Language Environment:

```
FILE *stream;  
stream = fopen("parts.instock", "r");
```

## Using a DDname

The DD statement enables you to write C or C++ source programs that are independent of the files and input/output devices they use. You can modify the parameters of a file or process different files without recompiling your program.

Use ddnames if you want to use non-DASD devices.

If you specify DISP=MOD on a DD statement and w or wb mode on the fopen() call, z/OS XL C/C++ treats the file as if you had opened it in append mode instead of write mode.

To open a file by ddname under z/OS batch, you must define the ddname first. You can do this in any of the following ways:



- In batch (z/OS, TSO, or IMS), you can write a JCL DD statement. For the declaration shown above for the C or C++ file PARTS.INSTOCK, you write a JCL DD statement similar to the following:

```
//STOCK DD DSN=USERID.PARTS.INSTOCK,DISP=SHR
```

When defining DD, do not use DD ... FREE=CLOSE for unallocating DD statements. The C library may close files to perform some file operations such as freopen(), and the DD statement will be unallocated.

If you use SPACE=RLSE on a DD statement, z/OS XL C/C++ releases space only if all of the following are true:

- The file is open in w, wb, a, or ab mode
- It is not simultaneously open for read
- No positioning functions (fseek(), ftell(), rewind(), fgetpos(), fsetpos()) have been performed.

For more information on writing DD statements, refer to the job control language (JCL) manuals listed in *z/OS V2R2 Information Roadmap*.

- Under TSO (interactive and batch), you can issue an ALLOCATE command. The DD definition shown above for the C file STOCK has an equivalent TSO ALLOCATE command, as follows:

```
ALLOCATE FILE(STOCK) DATASET(PARTS.INSTOCK) SHR
```

See *z/OS V2R2 Information Roadmap* for manuals containing information on TSO ALLOCATE.

- In the z/OS environment, you can use the svc99() or dynaloc() library functions to define ddnames. For information about these functions, refer to *z/OS XL C/C++ Runtime Library Reference*.

**DCB parameter:** The DCB (data control block) parameter of the DD statement allows you to describe the characteristics of the data in a file and the way it will be processed at run time. The other parameters of the DD statement deal chiefly with the identity, location, and disposition of the file. The DCB parameter specifies information required for the processing of the records themselves. The subparameters of the DCB parameter are described in *z/OS MVS JCL User's Guide*.

The DCB parameter contains subparameters that describe:

- The organization of the file and how it will be accessed. Parameters supplied on fopen() override those specified in DCB.
- Device-dependent information such as the recording technique for magnetic tape or the line spacing for a printer (for example: CODE, DEN, FUNC, MODE, OPTCD=J, PRTSP, STACK, SPACE, UNIT and TRTCH subparameters).
- The data set format (for example: BLKSIZE, LRECL, and RECFM subparameters).

You cannot use the DCB parameter to override information already established for the file in your C or C++ program (by the file attributes declared and the other attributes that are implied by them). DCB subparameters that attempt to change information already supplied by fopen() or freopen() are ignored. An example of the DCB parameter is:

```
DCB=(RECFM=FB,BLKSIZE=400,LRECL=40)
```

It specifies that fixed-length records, 40 bytes in length, are to be grouped in a block 400 bytes long. You can copy attributes from another data set by either setting the DCB parameter to DCB=(dsname) or using the SVC 99 services provided by the svc99() and dynaloc() library functions.

## Generation data group I/O

A Generation Data Group (GDG) is a group of related cataloged data sets. Each data set within a generation data group is called a generation data set. Generation data sets have sequentially ordered absolute and relative names that represent their age. The absolute generation name is the representation used by the catalog management routines in the catalog. The relative name is a signed integer used to refer to the latest (0), the next to the latest (-1), and so forth, generation. The relative number can also be used to catalog a new generation (+1). For more information on GDGs, see *z/OS DFSMS Using Data Sets*.

If you want to open a generation data set by data set name with `fopen()` or `freopen()`, you will require a model. This model specifies parameters for the group, including the maximum number of generations (the generation index). You can define such a model by using the Access Method Services `DEFINE` command. For more information on the `DEFINE` command, see *z/OS DFSMS Access Method Services Commands*. Note also that `fopen()` does not support a `DCB=` parameter. If you want to change the parameters, alter the JCL that describes the model and open it in `w` mode.

`z/OS` uses an absolute generation and version number to catalog each generation. The generation and version numbers are in the form `GxxxxVyy`, where `xxxx` is an unsigned 4-digit decimal generation number (0001 through 9999) and `yy` is an unsigned 2-digit decimal version number (00 through 99). For example:

- `A.B.C.G0001V00` is generation data set 1, version 0, in generation data group `A.B.C`.
- `A.B.C.G0009V01` is generation data set 9, version 1, in generation data group `A.B.C`.

The number of generations kept depends on the size of the generation index.

When you open a GDG by relative number, `z/OS XL C/C++` returns the relative generation in the `__dsname` field of the structure returned by the `fldata()` function. You cannot use the `rename()` library function to rename GDGs by relative generation number; rename GDG data sets by using their absolute names.

The example shown in Figure 13 on page 88 is valid only for `C`. The sample program (`CCNGOS1`) defines a GDG. The `fopen()` fails because it tries to change the `RECFM` of the data set.

---

```

/*-----
/* This example demonstrates GDG I/O
/*-----
/* Create GDG model MYGDG.MODEL and GDG name MYGDG
/*-----
//MODEL      EXEC PGM=IDCAMS
//DD1        DD DSN=userid.MYGDG.MODEL,DISP=(NEW,CATLG),
//            UNIT=SYSDA,SPACE=(TRK,(0)),
//            DCB=(LRECL=80,BLKSIZE=3120,RECFM=FB)
//SYSPRINT   DD SYSOUT=*
//SYSIN      DD *
DEFINE GDG -
            (NAME(userid.MYGDG) -
            EMPTY -
            SCRATCH -
            LIMIT(255))

/*
/*-----
/* Create GDG data set MYGDG(+1)
/*-----
//DATASET    EXEC PGM=IEFBR14
//DD1        DD DSN=userid.MYGDG(+1),DISP=(NEW,CATLG),
//            SPACE=(CYL,(1,1)),UNIT=SYSDA,
//            DCB=userid.MYGDG.MODEL
//SYSPRINT   DD SYSOUT=*
//SYSIN      DD DUMMY
/*-----
/* Compile, link, and run an inlined C program.
/* This program attempts to open the GDG data set MYGDG(+1) but
/* should fail as it is opening the data set with a RECFM that is
/* different from that of the GDG model (F versus FB).
/*-----
//C          EXEC EDCCLG,
//            CPARM='NOSEQ,NOMARGINS'
//COMPILE.SYSIN DD DATA,DLM='>'
#include <stdio.h>
#include <errno.h>

int main(void)
{
    FILE *fp;

    fp = fopen("MYGDG(+1)", "a,recfm=F");

    if (fp == NULL)
    {
        printf("Error...Unable to open file\n");
        printf("errno ... %d\n",errno);
        perror("perror ... ");
    }

    printf("Finished\n");
}
/>

```

---

Figure 13. Generation data group example for C

The example shown in Figure 14 on page 89 (CCNGOS2) is valid only C++.

---

```

/*-----
/* This example demonstrates GDG I/O
/*-----
/* Create GDG model MYGDG.MODEL and GDG name MYGDG
/*-----
//MODEL      EXEC PGM=IDCAMS
//DD1        DD DSN=userid.MYGDG.MODEL,DISP=(NEW,CATLG),
//            UNIT=SYSDA,SPACE=(TRK,(0)),
//            DCB=(LRECL=80,BLKSIZE=3120,RECFM=FB)
//SYSPRINT   DD SYSOUT=*
//SYSIN      DD *
DEFINE GDG -
            (NAME(userid.MYGDG) -
            EMPTY -
            SCRATCH -
            LIMIT(255))
/*
/*-----
/* Create GDG data set MYGDG(+1)
/*-----
//DATASET    EXEC PGM=IEFBR14
//DD1        DD DSN=userid.MYGDG(+1),DISP=(NEW,CATLG),
//            SPACE=(CYL,(1,1)),UNIT=SYSDA,
//            DCB=userid.MYGDG.MODEL
//SYSPRINT   DD SYSOUT=*
//SYSIN      DD DUMMY
/*-----
/* Compile, bind, and run an inlined C++ program.
/* This program attempts to open the GDG data set MYGDG(+1) but
/* should fail as it is opening the data set with a RECFM that is
/* different from that of the GDG model (F versus FB).
/*-----
/*
//DOCLG1     EXEC CBCCBG,
//            CPARM='NOSEQ,NOMARGINS'
//COMPILE.SYSIN DD DATA,DLM='<>'
#include <stdio.h>
#include <errno.h>
int main(void)
{
    FILE *fp;

    fp = fopen("MYGDG(+1)", "a,recfm=F");

    if (fp == NULL)
    {
        printf("Error...Unable to open file\n");
        printf("errno ... %d\n",errno);
        perror("perror ... ");
    }

    printf("Finished\n");
}

```

---

Figure 14. Generation data group example for C++

A relative number used in the JCL refers to the same generation throughout a job. The (+1) used in the example above exists for the life of the entire job and not just the step, so that `fopen()`'s reference to (+1) did not create another new data set but accessed the same data set as in previous steps.

**Note:** You cannot use `fopen()` to create another generation data set because `fopen()` does not fully support the DCB parameter.

## Regular and extended partitioned data sets

Partitioned data sets (PDS) and partitioned data sets extended (PDSE) are DASD data sets divided into sections known as *members*. Each member can be accessed

individually by its unique 1- to 8-character name. As Table 18 shows, PDSEs are similar to PDSs, but contain a number of enhancements.

*Table 18. PDSE and PDS differences*

PDSE Characteristics	PDS Characteristics
Data set has a 123-extent limit	Data set has a 16-extent limit
Directory is open-ended and indexed by member name; faster to search directory	Fixed-size directory is searched sequentially
PDSEs are device-independent: records are reblockable	Block sizes are device-dependent
Uses dynamic space allocation and reclamation	Must use IEBCOPY COMPRESS to reclaim space
Supports creation of more than one member at a time*	Supports creation of only one member at a time

**Note:** \*z/OS XL C/C++ allows you to open two separate members of a PDSE for writing at the same time. However, you cannot open a single member for writing more than once.

You specify a member by enclosing its name in parentheses and placing it after the data set name. For example, the following JCL refers to member A of the data set MY.DATA:

```
//MYDD DD DSN=userid.MY.DATA(A),DISP=SHR
```

You can specify members on calls to `fopen()` and `freopen()`. You can specify members when you are opening a data set by its data set name or by a `ddname`. When you use a `ddname` and a member name, the definition of the `ddname` must not also specify a member. For example, using the DD statement above, the following will fail:

```
fp = fopen("dd:MYDD(B)","r");
```

You cannot open a PDS or PDSE member using the modes `a`, `ab`, `a+`, `a+b`, `w+`, `w+b`, or `wb+`. If you want to perform the equivalent of the `w+` or `wb+` mode, you must first open the file as `w` or `wb`, write to it, and then close it. Then you can perform updates by reopening the file in `r+` or `rb+` mode. You can use the C library functions `ftell()` or `fgetpos()` to obtain file positions for later updates to the member. Normally, opening a file in `r+` or `rb+` mode enables you to extend a file by writing to the end; however, with these modes you cannot extend a member. To do so, you must copy the contents of the old member plus any extensions to a new member. You can remove the old member by using the `remove()` function and then rename the new member to the old name by using `rename()`.

All members have identical attributes for `RECFM`, `LRECL`, and `BLKSIZE`. For PDSs, you cannot add a member with different attributes or specify a `RECFM` of `FBS`, `FBSA`, or `FBSM`. z/OS XL C/C++ verifies any attributes you specify.

For PDSEs, z/OS XL C/C++ checks to make sure that any attributes you specify are compatible with those of the existing data set. Compatible attributes are those that specify the same record format (`F`, `V`, or `U`) and the same `LRECL`. Compatibility of attributes enables you to choose whether to specify blocked or unblocked format, because PDSEs reblock all the records. For example, you can create a PDSE as `FB LRECL=40 BLKSIZE=80`, and later open it for read as `FB LRECL=40 BLKSIZE=1600` or `F LRECL=40 BLKSIZE=40`. The `LRECL` cannot change, and the `BLKSIZE` must be compatible with the `RECFM` and `LRECL`. Also, you cannot change the basic format of the PDSE from `F` to `V` or vice versa. If the PDS or PDSE

already exists, you do not need to specify any attributes, because z/OS XL C/C++ uses the previously existing ones as its defaults.

At the start of each partitioned data set is its directory, a series of records that contain the member names and starting locations for each member within the data set. You can access the directory by specifying the PDS or PDSE name without specifying a member. You can open the directory only for read; update and write modes are not allowed. The only RECFM that you can specify for reading the directory is RECFM=U. However, you do not need to specify the RECFM, because z/OS XL C/C++ uses U as the default.

*z/OS DFSMS Using Data Sets* contains more detailed explanations about how to use PDSs and PDSEs.

## Partitioned and sequential concatenated data sets

There are two forms of concatenated data sets: partitioned and sequential. You can open concatenated data sets only by ddname, and only for read or update. Specifying any of the write, or append modes fails. As with PDS members, you cannot extend a concatenated data set.

**Partitioned concatenation** consists of specifying multiple PDSs or PDSEs under one ddname. When you access the concatenation, it acts as one large PDS or PDSE, from which you can access any member. If two or more partitioned data sets in the concatenation contain a member with the same name, using the concatenation ddname to specify that member refers to the first member with that name found in the entire concatenation. You cannot use the ddname to access subsequent members. For example, if you have a PDS named PDS1, with members A, B, and C, and a second PDS named PDS2, with members C, D, and E, and you concatenate the two data sets as follows:

```
//MYDD DD userid.PDS1,DISP=SHR
// DD userid.PDS2,DISP=SHR
```

and perform the following:

```
fp = fopen("DD:MYDD(C)","r");
fp2 = fopen("DD:MYDD(D)","r");
```

the first call to `fopen()` finds member C from PDS1, even though there is also a member C in PDS2. The second call finds member D from PDS2, because PDS2 is the first PDS in the concatenation that contains this member. The member C in PDS2 is inaccessible.

When you are concatenating partitioned data sets, be aware of the DCB attributes for them. The concatenation is treated as a single data set with the following attributes:

- RECFM= the RECFM of the first data set in the concatenation
- LRECL= the LRECL of the first data set in the concatenation
- BLKSIZE= the largest BLKSIZE of any data set in the concatenation

Table 19 describes the rules for compatible concatenations.

*Table 19. Rules for possible concatenations*

RECFM of first data set	RECFM of subsequent data sets	LRECL of subsequent data sets
RECFM=F	RECFM=F	Same as that of first one

Table 19. Rules for possible concatenations (continued)

RECFM of first data set	RECFM of subsequent data sets	LRECL of subsequent data sets
RECFM=FB	RECFM=F or RECFM=FB	Same as that of first one
RECFM=V	RECFM=V	Less than or equal to that of first one
RECFM=VS	RECFM=V or RECFM=VS	Less than or equal to that of first one
RECFM=VB	RECFM=V or RECFM=VB	Less than or equal to that of first one
RECFM=VBS	RECFM=V, RECFM=VB, RECFM=VS, or RECFM=VBS	Less than or equal to that of first one
RECFM=U	RECFM=U or RECFM=F (see note)	

**Note:** You can use a data set in V-format, but when you read it, you will see all of the BDWs and RDWs or SDWs with the data.

If the first data set is in ASA format, all subsequent data sets must be ASA as well. The preceding rules apply to ASA files if you add an A to the RECFMs specified.

If you do not follow these rules, undefined behavior occurs. For example, trying to read a fixed-format member as RECFM=V could cause an exception or abend.

Repositioning is supported as it is for regular PDSs and PDSEs. If you try to read the directory, you will be able to read only the first one.

**Sequential concatenation** consists of treating multiple sequential data sets or partitioned data set members as one long sequential data set.

```
//MYDD DD userid.PDS1(A),DISP=SHR
//      DD userid.PDS2(E),DISP=SHR
//      DD userid.DATA,DISP=SHR
```

creates a concatenation that contains two members and a regular sequential data set. You can read or update all of these in order. In partitioned concatenations, you can read only one member at a time.

z/OS XL C/C++ does not support concatenating data sets that do not have compatible DCB attributes. The rules for compatibility are the same as those for partitioned concatenations.

If all the data sets in the concatenation support repositioning, you can reposition within a concatenation by using the functions `fseek()`, `ftell()`, `fgetpos()`, `fsetpos()`, and `rewind()`. If the first one does not, all of the repositioning functions except `rewind()` fail for the entire concatenation. If the first data set supports repositioning but a subsequent one does not, you must specify the `noseek()` parameter on the `fopen()` or `freopen()` call. If you do not, `fopen()` or `freopen()` opens the file successfully; however, an error occurs when the read position gets to the data set that does not support repositioning.

**Note:** Concatenated and multivolume data sets only tolerate single buffering mode.

## In-stream data sets

An *in-stream data set* is a data set contained within a set of JCL statements. In-stream data sets (also called inline data sets) begin with a DD \* or DD DATA statement. These DD statements can have any valid ddname, including SYSIN. If you omit a DD statement before the input data, the system provides a DD \* statement with the ddname of SYSIN. This example shows you how to indicate an in-stream data set:

```
//MYDD DD *  
record 1  
record 2  
record 3  
/*
```

The // at the beginning of the data set starts in column 1. The statement `fopen("DD:MYDD","rb");` opens a data set with `lrecl=80`, `blksize=80`, and `recfm=FB`. In this example, the delimiter indicating the end of the data set is `/*`. In some cases, your data may contain this string. For example, if you are using C source code that contains comments, z/OS XL C/C++ treats the beginning of the first comment as the end of the in-stream data set. To avoid this occurrence, you can change the delimiter by specifying `DLM=nn`, where `nn` is a two-character delimiter, on the DD statement that identifies the file. For example:

```
//MYDD DD *,DLM=çç  
#include <stdio.h>  
/* Hello, world program */  
int main() {printf("Hello, world\n"); }  
@@
```

For more information about in-stream data sets, see *z/OS MVS JCL User's Guide*.

To open an in-stream data set, call the `fopen()` or `freopen()` library function and specify the ddname of the data set. You can open an in-stream data set only for reading. Specifying any of the update, write, or append modes fails. Once you have opened an in-stream data set, you cannot acquire or change the file position except by rewinding. This means that calls to the `fseek()`, `ftell()`, `fgetpos()`, and `fsetpos()` for in-stream data sets fail. Calling `rewind()` causes z/OS XL C/C++ to reopen the file, leaving the file position at the beginning.

You can concatenate regular sequential data sets and in-stream data sets. If you do so, note the following:

- If the first data set is in-stream, you cannot acquire or change the file position for the entire concatenation.
- If the first data set is not in-stream and supports repositioning, you must specify the `noseek` parameter on the `fopen()` or `freopen()` call that opens the concatenation. If you do not, `fopen()` or `freopen()` opens the file successfully; however, an error occurs when the read position gets to the in-stream.
- The in-stream data set is treated as FB 80 and the concatenation rules for sequential concatenation apply.

## SYSOUT data sets

You can specify a SYSOUT data set by using the SYSOUT parameter on a DD statement. z/OS XL C/C++ supports opening SYSOUT data sets in two ways:



1. Specifying a ddname that has the SYSOUT parameter. For information about defining ddnames, see “Using a DDname” on page 85.
2. Specifying a data set name of \* on a call to fopen() or freopen() while you are running under z/OS batch or IMS online or batch.

On a DD statement, you specify SYSOUT=*x*, where *x* is the output class. If the class matches the JOB statement MSGCLASS, the output appears with the job log. You can specify a SYSOUT data set and get the job MSGCLASS by specifying SYSOUT=\*. If you want to create a job stream within your program, you can specify INTRDR on the DD statement. This sends your SYSOUT data set to the internal reader to be read as an input job stream. For example,

```
//MYDD DD SYSOUT=(A,INTRDR)
```

For more details about the SYSOUT parameter, refer to *z/OS MVS JCL User's Guide*.

You can specify DCB attributes for a SYSOUT data set on a DD statement or a call to fopen() or freopen(). If you do not, z/OS XL C/C++ uses the following defaults:

**Binary, Record I/O, or Blocked I/O**

```
RECFM=VB LRECL=137 BLKSIZE=882
```

**Text I/O**

```
RECFM=VBA LRECL=137 BLKSIZE=882
```

## Tapes

z/OS XL C/C++ supports standard label (SL) tapes. If you are creating tape files, you can only open them by ddname. z/OS XL C/C++ provides support for opening tapes in read, write, or append mode, but not update. When you open a tape for read or append, any data set control block (DCB) characteristics you specify must match those of the existing data set exactly. The repositioning functions are available only when you have opened a tape for read. For tapes opened for write or append, calling rewind() has no effect; calls to any of the other repositioning functions fail. To open a tape file for write, you must open it by ddname.

Opening FBS-format tape files with append-only mode is not supported.

When you open a tape file for output, the data set name you specify in the JCL must match the data set name specified in the tape label, even if the existing tape file is empty. If this is not the case, you must either change the JCL to specify the correct data set name or write to another tape file, or reinitialize the tape to remove the tape label and the data. You can use IEBGENER with the following JCL to create an empty tape file before passing it to the subsequent steps:

```
//ALLOC EXEC PGM=IEBGENER
//SYSUT1 DD *
/*
//SYSUT2 DD DSN=name-of-OUTPUT-tape-file,UNIT=xxxx,LABEL=(x,SL),
//      DISP=(NEW,PASS),(DCB=LRECL=xx,BLKSIZE=xx,RECFM=xx),
//      VOL=SER=xxx
//SYSIN DD DUMMY
//SYSPRINT DD SYSOUT=*
```

**Note:** For tapes, the value for UNIT= can be TAPE or CART.

Because the C library does not create tape files, you can append only to a tape file that already exists. Attempting to append to a file that does not already exist on a tape will cause an error. You can create an empty data set on a tape by using the utility IEBGENER.

## Multivolume data sets

z/OS XL C/C++ supports data sets that span more than one volume of DASD or tape. You can open multivolume DASD data sets for read (r,rb), write (w,wb), update (r+,rb+,w+,wb+), or append (a,a+,ab,ab+) by dsname and ddname. Multivolume data sets can be extended only in read/update mode (r+,rb+).

The repositioning functions are available when you have opened a multivolume data set for r,r+,rb,rb+,w+,wb+,a+,ab+. Repositioning multivolume data sets opened for w,wb,a,ab is not allowed because it would be meaningless. For multivolume data sets opened for write, calling `rewind()` has no effect; calls to any of the other repositioning functions fail.

Here is an example of a multivolume data set declaration:

```
//MYDD DD DSN=TEST.TWO,DISP=(NEW,CATLG),
//      VOLUME=(,3,SER=(333001,333002,333003)),
//      SPACE=(TRK,(9,10)),UNIT=(3390,P)
```

This creates a data set that may span up to three volumes. For more information about the `VOLUME` parameter on DD statements, refer to *z/OS MVS JCL User's Guide*.

### Notes:

1. Simultaneous readers (files that can support sharing by a writer and one or more readers) are not supported for multivolume data sets.
2. Concatenated and multivolume data sets only tolerate single buffering mode.

## Striped data sets

z/OS XL C/C++ supports extended format sequential data sets. Extended format data sets must be SMS-managed. Optionally, extended format data sets can be striped. Striping spreads a data set over a specified number of volumes such that I/O parallelism can be exploited. Unlike a multivolume data set in which physical record `n` follows record `n-1`, a striped data set has physical records `n` and `n-1` on separate volumes. This enables asynchronous I/O to perform parallel operations, making requests for multiple reads and writes faster.

Striped data sets also facilitate repositioning once the relative block number is known. z/OS XL C/C++ exploits this capability when it uses `fseek()` to reposition. This can result in substantial savings for applications that use `ftell()` and `fseek()` with data sets that have RECFMs of V, U, and FB (not FBS). data sets. When a data set is striped, an `fseek()` can seek directly to the specified block just as an `fsetpos()` or `rewind()` can. For a normal data set with the aforementioned RECFMs, z/OS XL C/C++ has to read forward or rewind the data set to get to the desired position. Depending on how large the data set is, this can be quite inefficient compared to a direct reposition. Note that for such data sets, striping pads blocks to their maximum size. Therefore, you may be wasting space if you have short records.

## Large format sequential data sets

A large format sequential data set is a modification to traditional sequential data sets that allows for more than 65535 tracks of data per volume. Large format sequential data sets can be single or multivolume, and can reside on SMS managed or non-SMS managed direct access storage devices.

A large format sequential data set is specified using the DSNTYPE=LARGE keyword on a JCL DD statement or using the dynamic allocation equivalent. z/OS XL C/C++ does not support the allocation of a large format sequential data set using fopen() or freopen().

z/OS XL C/C++ provides complete read and write support for:

- Large format sequential data sets when seek is requested (not specifying the noseek keyword).
- Large format sequential data sets when noseek is requested and honored. See “Access method selection” on page 97 for more information on when noseek is requested but not honored.

**Note:** Restrictions associated with traditional sequential single and multivolume data sets, or concatenations of such data sets, continue to apply when the data set is large format.

## Other devices

z/OS XL C/C++ supports several other devices for input and output. You can open these devices only by ddname. Table 20 lists a number of these devices and describes which record formats are valid for them. None of the devices listed can be opened for update except the DUMMY data set.

Table 20. Other devices supported for input and output

Device	Valid open modes	Repositioning?	fldata().__device
Printer	w, wb, a, ab	No	__PRINTER
Card reader	r, rb	rewind() only	__OTHER
Card punch	w, wb, a, ab	No	__OTHER
Optical reader	r, rb	rewind() only	__OTHER
DUMMY data set	r, rb, r+, rb+, r+b, w, wb, w+, wb+ w+b, a, ab, a+, ab+, a+b	rewind() only	__DUMMY
SUBSYS=	r, rb	No	__OTHER

**Note:** For all devices above that support open modes a or ab, the modes are treated as if you had specified w or wb.

z/OS XL C/C++ queries each device to find out its maximum BLKSIZE.

The DUMMY data set is not truly a device, although z/OS XL C/C++ treats it as one. To use the DUMMY data set, specify DD DUMMY in your JCL. On input, the DUMMY data set always returns EOF; on output, it is always successful. This is the way to specify a DUMMY data set:

```
//MYDD DD DUMMY
```

For more information on DUMMY data sets, see *z/OS MVS JCL User's Guide*.

z/OS XL C/C++ provides minimal support for subsystem (SUBSYS=) managed data sets. Support is limited to opening for read using the `dd:ddname(member)` syntax with the `fopen()` filename. The `ddname` in the JCL stream must specify the `SUBSYS=` parameter. In this case, `fopen()` will open the DCB as `DSORG=PS`, required for subsystem managed data sets, but will perform the `BLDL/FIND` sequence to allow the subsystem to manage processing of the desired member.

## Access method selection

The `fopen()` and `freopen()` keyword `noseek` requests QSAM (queued sequential access method) be used to process the data set. This request also indicates that the repositioning functions will not be used by the application. This access method generally provides the best performance. Omitting the keyword `noseek` selects BSAM (basic sequential access method) with `NOTE` and `POINT` macros requested, allowing repositioning functions to be used (where applicable) on the stream.

The following scenarios exist where QSAM (`noseek`) is requested, but the z/OS XL C/C++ runtime Library switches to BSAM with `NOTE` and `POINT` macros requested (`seek`):

- The data set is opened for update (`r+`, `rb+`, `w+`, `wb+`, `a+`, `ab+`)
- The data set is already opened for write (or update) in the same C process
- The data set is `RECFM=FBS` opened for append (`a`, `ab`, `a+`, `ab+`)
- The data set is `LRECL=X`
- The data set is the directory of a partitioned data set (`PDS` or `PDSE`)
- The data set is a member of a partitioned data set where the member was not specified at allocation, but rather specified at `fopen()` or `freopen()`

**Note:** Repositioning is not allowed when `noseek` is requested, even if there was a switch to `seek`.

## fopen() and freopen() parameters

Table 21 lists the parameters that are available on the `fopen()` and `freopen()` functions, tells you which ones are allowed and applicable for OS I/O, and lists the option values that are valid for the applicable ones. Detailed descriptions of these options follow the table.

*Table 21. Parameters for the fopen() and freopen() functions for z/OS OS I/O*

Parameter	Allowed?	Applicable?	Notes
<code>recfm=</code>	Yes	Yes	Any of the 27 record formats available under z/OS XL C/C++, plus * and A are valid.
<code>lrecl=</code>	Yes	Yes	0, any positive integer up to 32760, or X is valid. See the parameter list below.
<code>blksize=</code>	Yes	Yes	0 or any positive integer up to 32760 is valid.
<code>space=</code>	Yes	Yes	Valid only if you are opening a new data set by its data set name. See the parameter list below.
<code>type=</code>	Yes	Yes	May be omitted. If you do specify it, <code>type=record</code> or <code>type=blocked</code> can be the valid values.
<code>acc=</code>	Yes	No	Not used for OS I/O.
<code>password=</code>	Yes	No	Not used for OS I/O.
<code>asis</code>	Yes	No	Used to specify mixed-case filenames. Not recommended.

Table 21. Parameters for the `fopen()` and `freopen()` functions for z/OS OS I/O (continued)

Parameter	Allowed?	Applicable?	Notes
<code>bytesek</code>	Yes	Yes	Used for binary files to specify that the seeking functions should use relative byte offsets instead of encoded offsets.
<code>noseek</code>	Yes	Yes	Used to disable seeking functions for improved performance.
<code>OS</code>	Yes	No	Ignored.
<code>abend=</code>	Yes	Yes	See note below.

### **recfm=**

z/OS XL C/C++ allows you to specify any of the 27 possible RECFM types (listed in “Fixed-format records” on page 12, “Variable-format records” on page 16, and “Undefined-format records” on page 19), as well as the z/OS XL C/C++ RECFMs \* and A.

When you are opening an existing file for read or append (or for write, if you have specified `DISP=MOD`), any RECFM that you specify must match that of the existing file, except that you may specify `recfm=U` to open any file for read, and you may specify `recfm=FBS` for a file created as `recfm=FB`. Specifying `recfm=FBS` indicates to z/OS XL C/C++ that there are no short blocks within the file. If there are, undefined behavior results.

For variable-format OS files, the `RDW`, `SDW`, and `BDW` contain the length of the record, segment, and block as well as their own lengths. If you open a file for read with `recfm=U`, z/OS XL C/C++ treats each physical block as an undefined-format record. For files created with `recfm=V`, z/OS XL C/C++ does not strip off block descriptor words (BDWs) or record descriptor words (RDWs), and for blocked files, it does not deblock records. Using `recfm=U` is helpful for viewing variable-format files or seeing how records are blocked in the file.

When you are opening an existing PDS or PDSE for write and you specify a RECFM, it must be compatible with the RECFM of the existing data set. `FS` and `FBS` formats are invalid for PDS members. For PDSs, you must use exactly the same RECFM. For PDSEs, you may choose to change the blocked attribute (`B`), because PDSEs perform their own blocking. If you want to read a PDS or PDSE directory and you specify a RECFM, it must be `recfm=U`.

Specifying `recfm=A` indicates that the file contains ASA control characters. If you are opening an existing file and you specify that ASA characters exist (`>recfm=A`) when they do not, the call to `fopen()` or `freopen()` fails. If you create a file by opening it for write or append, the `A` attribute is added to the default RECFM. For more information about ASA, see Chapter 7, “Using ASA text files,” on page 47.

Specifying `recfm=*` causes z/OS XL C/C++ to fill in any attributes that you do not specify, taking the attributes from the existing data set. This is useful if you want to create a new version of a data set with the same attributes as the previous version. If you open a data set for write and the data set does not exist, z/OS XL C/C++ uses the default attributes specified in “`fopen()` defaults” on page 34. This parameter has no effect when you are opening for read or append, and when you use it for non-DASD files.

`recfm=+` is identical to `recfm=*` with the following exceptions:

- If there is no record format for the existing DASD data set, the defaults are assigned as if the data set did not exist.

- When append mode is used, the `fopen()` fails.

#### **lrecl= and blksize=**

The LRECL that you specify on the `fopen()` call defines the maximum record length that the C library allows. Records longer than the maximum record length are not written to the file. The first 4 bytes of each block and the first 4 bytes of each record of variable-format files are used for control information. For more information, see “Variable-format records” on page 16.

The maximum LRECL supported for fixed, undefined, or variable-blocked-spanned format sequential disk files is 32760. For other variable-length format disk files the maximum LRECL is 32756. Sequential disk files for any format have a maximum BLKSIZE of 32760. The record length can be any size when opening a spanned file and specifying `lrecl=X`. You can now specify `lrecl=X` on the `fopen()` or `freopen()` call for spanned files. If you are updating an existing file, the file must have been originally opened with `lrecl=X` for the open to succeed. `lrecl=X` is useful only for text, record I/O, and blocked I/O.

When you are opening an existing file for read or append (or for write, if you have specified `DISP=MOD`), any LRECL or BLKSIZE that you specify must match that of the existing file, except when you open an F or FB format file on a disk device without specifying the `noseek` parameter. In this case, you can specify the S attribute to indicate to z/OS XL C/C++ that the file has no imbedded short blocks. Files without short blocks improve the performance of z/OS XL C/C++.

BLKSIZE=0 will be ignored for an existing data set opened for read or append.

When you are opening an existing PDS or PDSE for write and you specify an LRECL or BLKSIZE, it must be compatible with the LRECL or BLKSIZE of the existing data set. For PDSs, you must use exactly the same values. For PDSEs, the LRECL must be the same, but the BLKSIZE may be different if you have changed the blocking attribute as described under the RECFM parameter above. You can change the blocking attribute, because PDSEs perform their own blocking. The BLKSIZE you choose should be compatible with the RECFM and LRECL. When you open the directory of a PDS or PDSE, do not specify LRECL or BLKSIZE; z/OS XL C/C++ uses the defaults. See Table 22 on page 104 for more information.

#### **space=(units, (primary, secondary, directory) [rlse | norlse])**

This keyword enables you to specify the space parameters for the allocation of a z/OS data set. It applies only to z/OS data sets that you open by filename and do not already exist. If you open a data set by ddname, this parameter has no effect. You cannot specify any whitespace inside the value for the space keyword. You must specify at least one value with this parameter. Any parameter that you specify will be validated for syntax. If that validation fails, then the `fopen()` or `freopen()` will fail even if the parameter would have been ignored.

The supported values for *units* are as follows:

- Any positive integer indicating BLKSIZE
- CYL (mixed case)
- TRK (mixed case)

The primary quantity, the secondary quantity, and the directory quantity all must be positive integers. The primary quantity is always required.

If you specify values only for *units* and *primary*, you do not have to specify the inside set of parentheses. You can use a comma to indicate a quantity is to take



the default value. For example:

```
space=(cyl,(100,,10)) - default secondary value
space=(trk,(100,,)) - default secondary and directory value
space=(500,(100,)) - default secondary, no directory
```

The last parameter, `rlse` or `norlse`, controls the disposition of the unused space. If you open a new file for write and specify the space keyword, by default, any unused space will be released when the file is closed. You can preserve the allocated space by specifying `norlse`. For example:

```
space=(cyl,(100,,10),norlse) - does not release unused space
space=(trk,(100,,),rlse) - releases unused space
pace=(500,(100,)) - releases unused space
```

You can specify only the values indicated on this parameter. If you specify any other values, `fopen()` or `freopen()` fails. Any values not specified are omitted on the allocation. These values are filled by the system during SVC 99 processing.

#### **type=**

You can omit this parameter. If you specify it, the valid values for OS I/O are `type=record` which opens a file for record I/O, and `type=blocked` which opens a file for blocked I/O.

#### **acc=**

This parameter is not valid for OS I/O. If you specify it, z/OS XL C/C++ ignores it.

#### **password=**

This parameter is not valid for OS I/O. If you specify it, z/OS XL C/C++ ignores it.

#### **asis**

If you use this parameter, z/OS XL C/C++ does not convert your filenames to upper case. The use of the `asis` parameter is strongly discouraged, because most of the I/O services used by z/OS XL C/C++ require uppercase filenames.

#### **byteseek**

When you specify this parameter and open a file in binary mode, all repositioning functions (such as `fseek()` and `ftell()`) use relative byte offsets from the beginning of the file instead of encoded offsets. In previous releases of z/OS XL C/C++, byteseeeking was performed only for fixed format binary files. To have the `byteseek` parameter set as the default for all your calls to `fopen()` or `freopen()`, you can set the environment variable `_EDC_BYTE_SEEK` to `Y`. See Chapter 32, "Using environment variables," on page 467 for more information.

#### **noseek**

Specifying this parameter on the `fopen()` call disables the repositioning functions `ftell()`, `fseek()`, `fgetpos()`, and `fsetpos()` for as long as the file is open. When you have specified `NOSEEK` and have opened a disk file for read only, the only repositioning function allowed on the file is `rewind()`, if the device supports rewinding. Otherwise, a call to `rewind()` sets `errno` and raises `SIGIOERR`, if `SIGIOERR` is not set to `SIG_IGN`. Calls to `ftell()`, `fseek()`, `fsetpos()`, or `fgetpos()` return `EOF`, set `errno`, and set the stream error flag on.

The use of the `noseek` parameter may improve performance when you are reading and writing data sets.

**Note:** If you specify the `NOSEEK` parameter when you open a file for writing, you must specify `NOSEEK` on any subsequent `fopen()` call that simultaneously opens the file for reading; otherwise, you will get undefined behavior.

## OS

If you specify this parameter, z/OS XL C/C++ ignores it.

### **abend= abend | recover**

This parameter is ignored for SPC applications. The z/OS XL C/C++ runtime library uses the DCB ABEND exit to intercept abend conditions that occur during OS I/O operations. When an abend condition occurs, DFSMS issues a write-to-programmer message and gives control to the DCB ABEND exit. Within the information provided to the exit, a flag indicates if the abend condition can be ignored. It is not predictable when an abend condition can be ignored, and sometimes the same abend condition (completion code and reason code) can be ignored while at other times it cannot.

When the abend condition can be ignored, the runtime library instructs DFSMS to do so. This allows the runtime library to return gracefully back to the user code with a failing return value, `errno` set to 92 (meaning an I/O abend was trapped), and diagnostic information in the `__amrc` structure. DFSMS will have stopped processing the DCB. Only the `fldata()`, `fclose()`, and `freopen()` functions are permitted on the stream after an abend condition is trapped.

When the abend condition cannot be ignored, DFSMS issues the abend and Language Environment condition handling semantics take effect. If condition handling is active, the abend is converted to a Language Environment condition or SIGABND signal. In the absence of a condition handler or signal handler, the default behavior is to terminate the enclave. An application can write its own condition handler or SIGABND handler and try to recover from the error. As is the case when an abend condition can be ignored, DFSMS will have stopped processing the DCB and only the `fldata()`, `fclose()`, and `freopen()` functions are permitted on the stream.

**abend** instructs the runtime library to ignore abend conditions that can be ignored. No attempt is made to recover from abend conditions that cannot be ignored.

### **recover**

instructs the runtime library to attempt to recover from an abend issued during certain low-level I/O operations (`WRITE / CHECK` sequence, `CLOSE`, `GET`, and `PUT`). If recovery is possible, control will be returned to the user code with a failing return value, `errno` set to 92, and diagnostic information in the `__amrc` structure.

The `abend` keyword specifies the behavior only for the stream being opened. It overrides the setting of the `_EDC_IO_ABEND` environment variable. See Chapter 32, “Using environment variables,” on page 467 for more information. Also, see Chapter 18, “Debugging I/O programs,” on page 223 for more information on the `__amrc` structure and handling errors during I/O operations.

---

## Buffering

z/OS XL C/C++ uses buffers to map C I/O to system-level I/O. When z/OS XL C/C++ performs I/O operations, it uses one of the following buffering modes:



- *Line buffering* — characters are transmitted to the system when a new-line character is encountered. Line buffering is meaningless for binary, record I/O, and blocked I/O files.
- *Full buffering* — characters are transmitted to the system when a buffer is filled.

C/C++ provides a third buffering mode, unbuffered I/O, which is not supported for OS files.

You can use the `setvbuf()` and `setbuf()` library functions to set the buffering mode before you perform any I/O operation to the file. `setvbuf()` fails if you specify unbuffered I/O. It also fails if you try to specify line buffering for an FBS data set opened in text mode, where the device does not support repositioning. This failure happens because z/OS XL C/C++ cannot deliver records at line boundaries without violating FBS format. Do not try to change the buffering mode after you have performed any I/O operation to the file.

For all files except `stderr`, full buffering is the default, but you can use `setvbuf()` to specify line buffering. For binary files, record I/O files, and unblocked text files, a block is written out as soon as it is full, regardless of whether you have specified line buffering or full buffering. For blocked I/O files, a block is written out as soon as `fwrite()` completes. Line buffering is different from full buffering only for blocked text files.

## Multiple buffering

Multiple buffering (or asynchronous I/O) is supported for z/OS data sets. Multiple buffering is not supported for a data set opened for read at the same time that another file pointer has it opened for write or append. When you open files for multiple buffering, blocks are read into buffers before they are needed, eliminating the delay caused by waiting for I/O to complete. Multiple buffering may make I/O less efficient if you are seeking within or writing to a file, because seeking or writing may discard blocks that were read into buffers but never used.

To specify multiple buffering, code either the `NCP=xx` or `BUFNO=yy` subparameter of the DCB parameter on the JCL DD statement (or allocation), where `xx` is an integer number between 02 and 99, and `yy` is an integer number normally between 02 and 255. Whether z/OS XL C/C++ uses `NCP` or `BUFNO` depends on whether you are using BSAM or QSAM, respectively. `NCP` is supported under BSAM; `BUFNO` is supported under QSAM. BSAM and QSAM are documented in *z/OS DFSMS Using Data Sets*. If you specify `noseek`, z/OS XL C/C++ uses QSAM if possible. If z/OS XL C/C++ is using BSAM and you specify a value for `BUFNO`, z/OS XL C/C++ maps this value to `NCP`. If z/OS XL C/C++ is using QSAM and you specify a value for `NCP`, z/OS XL C/C++ maps this value to `BUFNO`.

If you specify both `NCP` and `BUFNO`, z/OS XL C/C++ takes the greater of the two values, up to the maximum for the applicable value. For example, if you specify a `BUFNO` of 120 and you are using BSAM, which uses `NCP` instead, z/OS XL C/C++ will use `NCP=99`.

If you do not specify either, z/OS XL C/C++ defaults to single buffering, except in the following cases, where z/OS XL C/C++ uses the system's default `BUFNO` and performs multiple buffering for both reading and writing:

- If you open a device that does not support repositioning, and specify read-only or write-only mode (`r`, `rb`, `w`, `wb`, `a`, `ab`).

- If you specify the NOSEEK parameter on the call to `fopen()` or `freopen()`, and specify read-only or write-only mode. When you specify NOSEEK, you get multiple buffering for both reads and writes.

Here is an example of how to specify BUFNO:

```
//DD5 DD DSN=TORONTO.BLUEJAYS,DISP=SHR,DCB=(BUFNO=5)
```

You may need to update code from previous releases that relies on z/OS XL C/C++ ignoring NCP or BUFNO parameters.

**Note:** Multiple buffering is ignored for concatenated and multivolume data sets.

---

## DCB (Data Control Block) attributes

For OS files, the C runtime library creates a skeleton data control block (DCB) for the file when you open it. File attributes are determined from the following sources in this order:

1. The `fopen()` or `freopen()` function call
2. Attributes for a ddname specified previously (if you are opening by ddname)
3. Existing file attributes (if you specify `recfm=*` or you are opening an existing file for read or append)
4. Defaults from `fopen()` or `freopen()` for creating a new file.

If you do not specify RECFM when you are creating a new file, z/OS XL C/C++ uses the following defaults:

- If `recfm` is not specified in a `fopen()` call for an output binary file, `recfm` defaults to:
  - `recfm=VB` for spool (printer) files,
  - `recfm=FB` otherwise.
- If `recfm` is not specified in a `fopen()` call for an output text file, `recfm` defaults to:
  - `recfm=F` if `_EDC_ANSI_OPEN_DEFAULT` is set to Y and no `LRECL` or `BLKSIZE` specified. In this case, `LRECL` and `BLKSIZE` are both defaulted to 254.
  - `recfm=VBA` for spool (printer) files.
  - `recfm=U` for terminal files
  - `recfm=V` if the `LRECL` or `BLKSIZE` is specified
  - `recfm=VB` for all other OS files.

If `recfm` is not specified for a record I/O or blocked I/O file, you will get the default of `recfm=VB`. Table 22 on page 104 shows the defaults for `LRECL` and `BLKSIZE` when the z/OS XL C/C++ compiler creates an OS file. Information from the C or C++ program overrides that from the DD statement and the tape label. Information from the DD statement overrides that from the data set label.

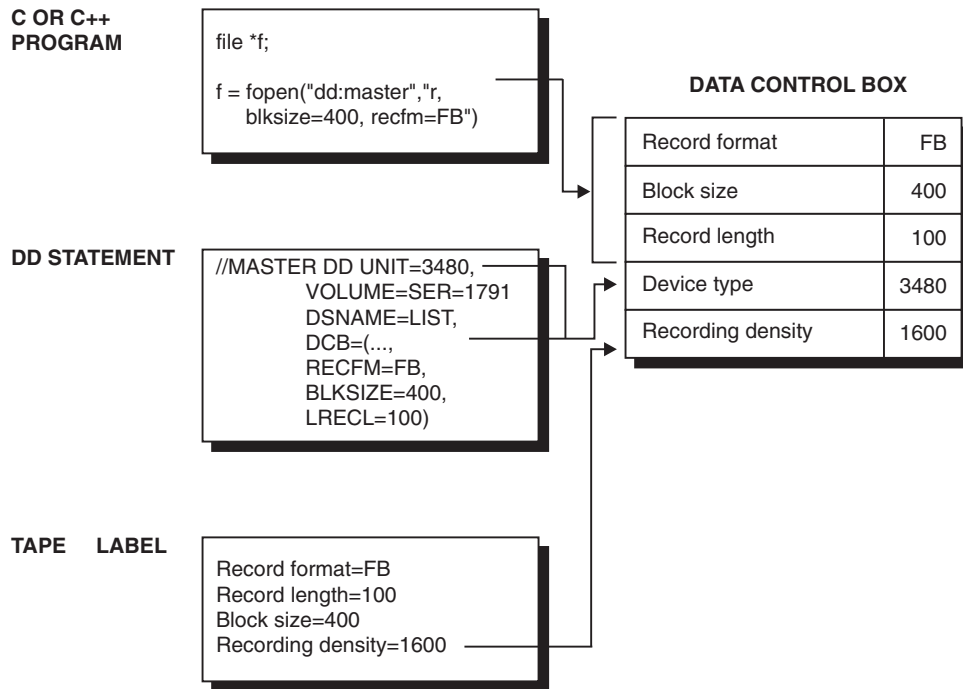

Figure 15. How the operating system completes the DCB

Table 22. `fopen()` defaults for `LRECL` and `BLKSIZE` when creating OS files

lrecl specified?	blksize specified?	RECFM	LRECL	BLKSIZE
no	no	All F	80	80
		All FB	80	maximum integral multiple of 80 less than or equal to <i>max</i>
		All V, VB, VS, or VBS	minimum of 1028 or <i>max-4</i>	<i>max</i>
		All U	0	<i>max</i>
yes	no	All F	<i>lrecl</i>	<i>lrecl</i>
		All FB	<i>lrecl</i>	maximum integral multiple of <i>lrecl</i> less than or equal to <i>max</i>
		All V	<i>lrecl</i>	<i>lrecl+4</i>
		All U	0	<i>lrecl</i>
no	yes	All F or FB	<i>blksize</i>	<i>blksize</i>
		All V, VB, VS, or VBS	minimum of 1028 or <i>blksize-4</i>	<i>blksize</i>
		All U	0	<i>blksize</i>

**Note:** All includes the standard (S) specifier for fixed formats, the ASA (A) specifier, and the machine control character (M) specifier.

In Table 22, the value *max* represents the maximum reasonable block size for the device. These are the current default maximum block sizes for several devices that z/OS XL C/C++ supports:

**Device Default maximum block size**

DASD	6144
3203 Printer	132
3211 Printer	132
4245 Printer	132
2540 Reader	80
2540 Punch	80
2501 Reader	80
3890 Document Processor	80
TAPE	32760

For more information about specific default block sizes as returned by the DEVTYPE macro, refer to *z/OS DFSMS Using Data Sets*.

You can perform multiple buffering under z/OS. See “Multiple buffering” on page 102 for details.

---

## Reading from files

You can use the following library functions to read from a file:

- fread()
- fread\_unlocked()
- fgetc()
- fgetc\_unlocked()
- fgets()
- fgets\_unlocked()
- fscanf()
- fscanf\_unlocked()
- getc()
- getc\_unlocked()
- gets()
- gets\_unlocked()
- getchar()
- getchar\_unlocked()
- scanf()
- scanf\_unlocked()
- vfscanf()
- vfscanf\_unlocked()
- vscanf()
- vscanf\_unlocked()

fread() is the only interface allowed for reading record I/O or blocked I/O files. Except for blocked I/O files, a read operation directly after a write operation

without an intervening call to `fflush()`, `fsetpos()`, `fseek()`, or `rewind()` fails. z/OS XL C/C++ treats the following as read operations:

- Calls to read functions that request 0 bytes
- Read requests that fail because of a system error
- Calls to the `ungetc()` function

z/OS XL C/C++ does not consider a read to be at EOF until you try to read past the last byte visible in the file. For example, in a file containing three bytes, the `feof()` function returns `FALSE` after three calls to `fgetc()`. Calling `fgetc()` one more time causes `feof()` to return `TRUE`.

You can set up a `SIGIOERR` handler to catch read or write system errors. See the debugging section in this book for more details.

## Reading from binary files

z/OS XL C/C++ reads binary records in the order that they were written to the file. Any null padding is visible and treated as data. Record boundaries are meaningless.

## Reading from text files

For non-ASA variable text files, the default for z/OS XL C/C++ is to ignore any empty physical records in the file. If a physical record contains a single blank, z/OS XL C/C++ reads in a logical record containing only a new-line. However, if the environment variable `_EDC_ZERO_RECLEN` was set to `Y`, z/OS XL C/C++ reads an empty physical record as a logical record containing a new-line, and a physical record containing a single blank as a logical record containing a blank *and* a new-line. z/OS XL C/C++ differentiates between empty records and records containing single blanks, and does not ignore either of them. For more information about how z/OS XL C/C++ treats empty records in variable format, see “Mapping C types to variable format” on page 18.

For ASA variable text files, if a file was created without a control character as its first byte, the first byte defaults to the ' ' character. When the file is read back, the first character is read as a new-line.

On input, ASA characters are translated to the corresponding sequence of control characters. For more information about using ASA files, refer to Chapter 7, “Using ASA text files,” on page 47.

For undefined format text files, reading a file causes a new-line character to be inserted at the end of each record. On input, a record containing a single blank character is considered an empty record and is translated to a new-line character. Trailing blanks are preserved for each record.

For files opened in fixed text format, rightmost blanks are stripped off a record at input, and a new-line character is placed in the logical record. This means that a record consisting of a single new-line character is represented by a fixed-length record made entirely of blanks.

## Reading from record I/O files

For files opened in record format, `fread()` is the only interface that supports reading. Each time you call `fread()` for a record I/O file, `fread()` reads one record. If you call `fread()` with a request for less than a complete record, the requested bytes are copied to your buffer, and the file position is set to the start of the next

record. If the request is for more bytes than are in the record, one record is read and the position is set to the start of the next record. z/OS XL C/C++ does not strip any blank characters or interpret any data.

`fread()` returns the number of items read successfully, so if you pass a `size` argument equal to 1 and a `count` argument equal to the maximum expected length of the record, `fread()` returns the length, in bytes, of the record read. If you pass a `size` argument equal to the maximum expected length of the record, and a `count` argument equal to 1, `fread()` returns either 0 or 1, indicating whether a record of length `size` was read. If a record is read successfully but is less than `size` bytes long, `fread()` returns 0.

A failed read operation may lead to undefined behavior until you reposition successfully.

## Reading from blocked I/O files

For files opened in blocked format, `fread()` is the only interface that supports reading. Each time you call `fread()` for a blocked I/O file, `fread()` reads one block. If you call `fread()` with a request for less than a complete block, the requested bytes are copied to your buffer, and the file position is set to the start of the next block. If the request is for more bytes than are in the block, one block is read and the position is set to the start of the next block. z/OS XL C/C++ does not strip any blank characters or interpret any data.

`fread()` returns the number of items read successfully, so if you pass a `size` argument equal to 1 and a `count` argument equal to the maximum expected length of the block, `fread()` returns the length, in bytes, of the block read. If you pass a `size` argument equal to the maximum expected length of the block, and a `count` argument equal to 1, `fread()` returns either 0 or 1, indicating whether a block of length `size` was read. If a block is read successfully but is less than `size` bytes long, `fread()` returns 0.

A failed read operation may lead to undefined behavior until you reposition successfully.

---

## Writing to files

You can use the following library functions to write to a file:

- `fwrite()`
- `fwrite_unlocked()`
- `printf()`
- `printf_unlocked()`
- `fprintf()`
- `fprintf_unlocked()`
- `vprintf()`
- `vprintf_unlocked()`
- `fprintf()`
- `fprintf_unlocked()`
- `puts()`
- `puts_unlocked()`
- `fputc()`
- `fputc_unlocked()`

- `fputs()`
- `fputs_unlocked()`
- `putc()`
- `putc_unlocked()`
- `putchar()`
- `putchar_unlocked()`

`fwrite()` is the only interface allowed for writing to record I/O or blocked I/O files. See *z/OS XL C/C++ Runtime Library Reference* for more information on these library functions.

A write operation directly after a read operation without an intervening call to `fflush()`, `fsetpos()`, `fseek()`, or `rewind()` fails unless the read operation has reached EOF. The file pointer does not reach EOF until after you have tried to read *past* the last byte of the file.

z/OS XL C/C++ counts a call to a write function writing 0 bytes or a write request that fails because of a system error as a write operation.

If you are updating a file and a system failure occurs, z/OS XL C/C++ tries to set the file position to the end of the last record updated successfully. For a fully-buffered file, this is at the end of the last record in a block. For a line-buffered file, this may be any record in the current block. If you are writing new data at the time of a system failure, z/OS XL C/C++ puts the file position at the end of the last block of the file. In files opened for blocked output, you may lose data written by other writes to that block before the system failure. The contents of a file after a system write failure are indeterminate.

If one user opens a file for writing, and another later opens the same file for reading, the user who is reading the file can check for records that may have been written past the end of the file by the other user. If the file is a spanned variable text file, the reader can read part of a spanned record and reach the end of the file before reading in the last segment of the spanned record.

## Writing to binary files

Data flows over record boundaries in binary files. Writes or updates past the end of a record go to the next record. When you are writing to files and not making any intervening calls to `fflush()`, blocks are written to the system as they are filled. If a fixed record is incomplete when you close the file, z/OS XL C/C++ completes it with nulls. You cannot change the length of existing records in a file by updating them.

If you are using variable binary files, note the following:

- On input and on update, records that have no length are ignored; you will not be notified. On output, zero-length records are not written. However, in spanned files, if the first segment of a record has been written to the system, and the user flushes or closes the file, a zero-length last segment may be written to the file.
- If you are writing new data in a data set that has variable-length records (RECFM=V, VB, VBM, etc.), z/OS XL C/C++ may split a record between two blocks to fill the first block out to the maximum block size. This means that when you read them, the record boundaries will not necessarily be the same.

- If your file is spanned, records are written up to length LRECL, spanning multiple blocks if necessary. You can create a spanned file by specifying a RECFM containing V and S on the fopen() call.

## Writing to text files

z/OS XL C/C++ treats the control characters as follows when you are writing to a non-ASA text file:

- \a** Alarm. Placed directly into the file; z/OS XL C/C++ does not interpret it.
- \b** Backspace. Placed directly into the file; z/OS XL C/C++ does not interpret it.
- \f** Form feed. Placed directly into the file; z/OS XL C/C++ does not interpret it.
- \n** New-line. Defines a record boundary; z/OS XL C/C++ does not place it in the file.
- \r** Carriage return. Defines a record boundary; z/OS XL C/C++ does not place it in the file. Treated like a new-line character.
- \t** Horizontal tab character. Placed directly into the file; z/OS XL C/C++ does not interpret it.
- \v** Vertical tab character. Placed directly into the file; z/OS XL C/C++ does not interpret it.
- \x0E** DBCS shift-out character. Indicates the beginning of a DBCS string, if MB\_CUR\_MAX > 1. Placed into the file.
- \x0F** DBCS shift-in character. Indicates the end of a DBCS string, if MB\_CUR\_MAX > 1. Placed into the file. See Chapter 8, “z/OS XL C Support for the double-byte character set,” on page 53 for more information about MB\_CUR\_MAX.

The way z/OS XL C/C++ treats text files depends on whether they are in fixed, variable, or undefined format, and whether they use ASA.

As with ASA files in other environments, the first character of each record is reserved for the ASA control character that represents a new-line, a carriage return, or a form feed. See Chapter 7, “Using ASA text files,” on page 47 for more information.

*Table 23. C control to ASA characters*

C Control Character Sequence	ASA Character	Description
\n	' '	skip one line
\n\n	'0'	skip two lines
\n\n\n	'-'	skip three lines
\f	'1'	new page
\r	'+'	overstrike

## Writing to fixed-format text files

Records in fixed-format files are all the same length. You complete each record with a new-line or carriage return character. For fixed text files, the new-line character is not written to the file. Blank padding is inserted to the LRECL of each



record of the block, and the block, when full, is written. For a more complete description of the way fixed-format files are handled, see “Fixed-format records” on page 12.

A logical record can be shortened to be an empty record (containing just a new-line) or extended to a record containing LRECL bytes of data plus a new-line. Because the physical record represents the new-line position by using padding blanks, the new-line position can be changed on an update as long as it is within the physical record.

**Note:** Using `ftell()` or `fgetpos()` values for positions that do not exist after you have shortened records results in undefined behavior.

When you are updating a file, writing new data into an existing record replaces the old data and, if the new data is longer or shorter than the old data, changes the size of the logical record by changing the number of blank characters in the physical record. When you extend a record, thereby writing over the old new-line, a new-line character is implied after the last character of the update. Calling `fflush()` flushes the data out to the file and inserts blank padding between the last data character and the end of the record. Once you have called `fflush()`, you can call any of the read functions, which begin reading at the new-line. Once the new-line is read, reading continues at the beginning of the next record.

### Writing to variable-format text files

In a file with variable-length records, each record may be a different length. The variable length formats permit both variable-length records and variable-length blocks. The first 4 bytes of each block are reserved for the Block Descriptor Word (BDW); the first 4 bytes of each record are reserved for the Record Descriptor Word (RDW).

For ASA and non-ASA, the `'\n'` (new-line) character implies a record boundary. On output, the new-line is not written to the physical file; instead, it is assumed to follow the data of the record.

If you have not set `_EDC_ZERO_RECLLEN`, z/OS XL C/C++ writes out a record containing a single blank character to represent a single new-line. On input, a record containing a single blank character is considered an empty record and is translated to a new-line character. Note that a single blank followed by a new-line is written out as a single blank, and is treated as just a new-line on input. When `_EDC_ZERO_RECLLEN` is set, writing a record containing only a new-line results in a zero-length variable record.

For more information about environment variables, refer to Chapter 32, “Using environment variables,” on page 467. For more information about how z/OS XL C/C++ treats empty records in variable format, see “Mapping C types to variable format” on page 18.

Attempting to shorten a record on update by specifying less data before the new-line causes the record to be padded with blanks to the original record size. For spanned records, updating a record to a shorter length results in the same blank padding to the original record length, over multiple blocks, if applicable.

Attempts to lengthen a record on update generally result in truncation. The exception to this rule is extending an empty record to a 1-byte record when the environment variable `_EDC_ZERO_RECLLEN` is not set. Because the physical representation for an empty record is a record containing one blank character, it is

possible to extend the logical record to a single non-blank character followed by a new-line character. For standard streams, truncation in text files does not occur; data is wrapped automatically to the next record as if you had added a new-line.

When you are writing data to a non-blocked file without intervening flush or reposition requests, each record is written to the system when a new-line or carriage return character is written or when the file is closed.

When you are writing data to a blocked file without intervening flush or reposition requests, if the file is opened in full buffering mode, the block is written to the system on completion of the record that fills the block. If the blocked file is line buffered, each record is written to the system when it is completed. If you are using full buffering for a VB format file, a write may not fill a block completely. The data does not go to the system unless a block is full; you can complete the block with another write. If the subsequent write contains more data than is needed to fill the block, it flushes the current block to the system and starts writing your data to a new block.

When you are writing data to a spanned file without intervening flush or reposition requests, if the record spans multiple blocks, each block is written to the system once it is full and the user writes an additional byte of data.

For ASA variable text files, if a file was created without a control character as its first byte or record (after the RDW and BDW), the first byte defaults to the ' ' character. When the file is read back, the first character is read as a new-line.

### **Writing to undefined-format text files**

In an undefined-format file, there is only one record per block. Each record may be a different length, up to a maximum length of BLKSIZE. Each record is completed with a new-line or carriage return character. The new-line character is not written to the physical file; it is assumed to follow the data of the record. However, if a record contains only a new-line character, z/OS XL C/C++ writes a record containing a single blank to the file to represent an empty record. On input, the blank is read in as a new-line.

Once a record has been written, you cannot change its length. If you try to shorten a logical record by updating it with a shorter record, z/OS XL C/C++ completes the record with blank padding. If you try to lengthen a record by updating it with more data than it can hold, z/OS XL C/C++ truncates the new data. The only instance in which this does not happen is when you extend an empty record so that it contains a single byte. Any data beyond the single byte is truncated.

### **Truncation versus splitting**

If you try to write more data to a record than z/OS XL C/C++ allows, and the file you are writing to is not one of the standard streams (the defaults, or those redirected by `freopen()` or command-level redirection), output is cut off at the record boundary and the remaining bytes are discarded. z/OS XL C/C++ does not count the discarded characters as characters that have been written out successfully.

In all truncation cases, the SIGIOERR signal is raised if the action for SIGIOERR is not SIG\_IGN. The user error flag is set so that `ferror()` will return TRUE. For more information about SIGIOERR, `ferror()`, and other I/O-related debugging tools, see Chapter 18, "Debugging I/O programs," on page 223. z/OS XL C/C++ continues to discard new output until you complete the current record by writing a new-line or carriage return character, close the file, or change the file position.

If you are writing to one of the standard streams, attempting to write more data than a record can hold results in the data being split across multiple records.

## Writing to record I/O files

`fwrite()` is the only interface allowed for writing to a file opened for record I/O. Only one record is written at a time. If you attempt to write more new data than a full record can hold or you try to update a record with more data than it currently has, z/OS XL C/C++ truncates your output at the record boundary. When z/OS XL C/C++ performs a truncation, it sets `errno` and raises `SIGIOERR`, if `SIGIOERR` is not set to `SIG_IGN`.

When you update a record, you can update less than the full record. The remaining data that you do not update is left untouched in the file.

When you are writing new records to a fixed-record I/O file, if you try to write a short record, z/OS XL C/C++ pads the record with nulls out to `LRECL`.

At the completion of an `fwrite()`, the file position is at the start of the next record. For new data, the block is flushed out to the system as soon as it is full.

## Writing to blocked I/O files

`fwrite()` is the only interface allowed for writing to a file opened for blocked I/O. Only one block is written at a time. If you attempt to write more new data than a full block can hold or you try to update a block with more data than it currently has, z/OS XL C/C++ truncates your output at the block boundary. When z/OS XL C/C++ performs a truncation, it sets `errno` and raises `SIGIOERR`, if `SIGIOERR` is not set to `SIG_IGN`.

When you write less than `BLKSIZE` bytes, if the request is to create a new block, a short block will be created; if it is to update an existing block, only requested part of the block will be updated. z/OS XL C/C++ will not check the provided data. At the completion of an `fwrite()`, the file position is at the start of the next block, and the block is flushed out to the system. You might need to consider the following cases:

- Because all fixed-format records must be full, any block you write must be multiple of a record. Otherwise, z/OS XL C/C++ will fail the write request.
- When updating an FBS short block at the end of file, it could be updated to a full block or a longer short block from start of the short block.
- When writing or appending to an FBS short block at the end of file, z/OS XL C/C++ will use the request buffer to replace the previous block, which might extend or shrink the short block.
- You must make sure that there is no short block in the middle of an FBS data set.
- You must make sure that BDWs, RDWs, and SDWs in a block of variable record file are correct.

---

## Flushing buffers

You can use the library function `fflush()` to flush streams to the system. For more information about `fflush()`, see *z/OS XL C/C++ Runtime Library Reference*.

The action taken by the `fflush()` library function depends on the buffering mode associated with the stream and the type of streams. If you call one z/OS XL C/C++ program from another z/OS XL C/C++ program by using the ANSI

system() function, all open streams are flushed before control is passed to the callee, and again before control is returned to the caller. If you are running with POSIX(0N), a call to the POSIX system() function does not flush any streams to the system.

## Updating existing records

Calling fflush() while you are updating flushes the updates out to the system. If you call fflush() when you are in the middle of updating a record, z/OS XL C/C++ writes the partially updated record out to the system. A subsequent write continues to update the current record.

## Reading updated records

If you have a file open for read at the same time that the file is open for write in the same application, you will be able to see the new data if you call fflush() to refresh the contents of the input buffer, as shown in Figure 16.

---

```
/* this example demonstrates how updated records are read */

#include <stdio.h>
int main(void)
{
    FILE * fp, * fp2;
    int rc, rc2, rc3, rc4;
    fp = fopen("a.b", "w+");

    fprintf(fp, "first record");

    fp2 = fopen("a.b", "r"); /* Simultaneous Reader */

    /* following gets EOF since fp has not completed first line
     * of output so nothing will be flushed to file yet */
    rc = fgetc(fp2);
    printf("return code is %i\n", rc);

    fputc('\n', fp); /* this will complete first line */
    fflush(fp); /* ensures data is flushed to file */

    rc2 = fgetc(fp2); /* this gets 'f' from first record */
    printf("value is now %c\n", rc2);

    rewind(fp);

    fprintf(fp, "some updates\n");
    rc3 = fgetc(fp2); /* gets 'i' ..doesn't know about update */
    printf("value is now %c\n", rc3);

    fflush(fp); /* ensure update makes it to file */

    fflush(fp2); /* this updates reader's buffer */

    rc4 = fgetc(fp2); /* gets 'm', 3rd char of updated record */
    printf("value is now %c\n", rc4);

    return(0);
}
```

---

Figure 16. Example of reading updated records

## Writing new records

Writing new records is handled differently for:

- Binary streams
- Text streams

- Record I/O
- Blocked I/O

## Binary streams

z/OS XL C/C++ treats line buffering and full buffering the same way for binary files.

If the file has a variable length or undefined record format, `fflush()` writes the current record out. This may result in short records. In blocked files, this means that the block is written to disk, and subsequent writes are to a new block. For fixed files, no incomplete records are flushed.

For single-volume disk files in FBS format, `fflush()` flushes complete records in an incomplete block out to the file. For all other types of FBS files, `fflush()` does not flush an incomplete block out to the file.

For files in FB format, `fflush()` always flushes out all complete records in the current block. For sequential DASD files, new completed records are added to the end of the flushed block if it is short. For non-DASD or non-sequential files, any new record will start a new block.

## Text streams

- Line-Buffered Streams

`fflush()` has no effect on line-buffered text files, because z/OS XL C/C++ writes all records to the system as they are completed. All incomplete new records remain in the buffer.

- Fully Buffered Streams

Calling `fflush()` flushes all completed records in the buffer, that is, all records ending with a new-line or carriage return (or form feed character, if you are using ASA), to the system. z/OS XL C/C++ holds any incomplete record in the buffer until you complete the record or close the file.

For ASA text files, if a flush occurs while an ASA character that indicates more than one new-line is being updated, the remaining new-lines will be discarded and a read will continue at the first data character. For example, if `'\n\n\n'` is updated to be `'\n\n'` and a flush occurs, then a `'0'` will be written out in the ASA character position.

## Record I/O

z/OS XL C/C++ treats line buffering and full buffering the same way for record I/O. For files in FB format, calling `fflush()` writes all records in the buffer to the system. For single-volume disk files in FBS format, `fflush()` will flush complete records in an incomplete block out to the file. For all other types of FBS files, `fflush()` will not flush an incomplete block out to the file. For all other formats, calling `fflush()` has no effect, because `fwrite()` has already written the records to disk.

## Blocked I/O

For all record formats and all buffering mode, calling `fflush()` has no effect, because `fwrite()` has already written the block to disk.

## ungetc() considerations

`ungetc()` pushes characters back onto the input stream for binary and text files. `ungetc()` handles only single-byte characters. You can use it to push back as many as four characters onto the `ungetc()` buffer. For every character pushed back with

`ungetc()`, `fflush()` backs up the file position by one character and clears all the pushed-back characters from the stream. Backing up the file position may end up going across a record boundary. Remember that for text files, z/OS XL C/C++ counts the new-lines added to the records as single-byte characters when it calculates the file position.

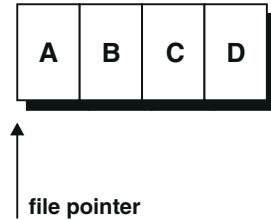

For example, given the stream you can run the following code fragment:

```
fgetc(fp);      /* Returns A and puts the file position at */
                /* the beginning of the character B */
ungetc('Z',fp); /* Logically inserts Z ahead of B */
fflush(fp);     /* Moves the file position back by one to A, */
                /* removes Z from the logical stream */
```

If you want `fflush()` to ignore `ungetc()` characters, you can set the `_EDC_COMPAT` environment variable. See Chapter 32, “Using environment variables,” on page 467 for more information.

---

## Repositioning within files

You can use the following library functions to help you position within a file:

- `fseek()`
- `fseek_unlocked()`
- `fseeko()`
- `fseeko_unlocked()`
- `ftell()`
- `ftell_unlocked()`
- `ftello()`
- `ftello_unlocked()`
- `fgetpos()`
- `fgetpos_unlocked()`
- `fsetpos()`
- `fsetpos_unlocked()`
- `rewind()`
- `rewind_unlocked()`

With large file support enabled for AMODE 31 C/C++ applications, you can use the following library functions for 64-bit offsets:

- `fseeko()`
- `fseeko_unlocked()`
- `ftello()`
- `ftello_unlocked()`

For AMODE 64 C/C++ applications, large files are automatically supported in the LP64 programming model. All of the above functions (both lists) can be used with 64-bit offsets.

See *z/OS XL C/C++ Runtime Library Reference* for more information on these library functions.

Opening a file with `fopen()` and specifying the `NOSEEK` parameter disables all of these library functions except `rewind()`. A call to `rewind()` causes the file to be reopened, unless the file is a non-disk file opened for write-only. In this case, `rewind()` sets `errno` and raises `SIGIOERR` (if `SIGIOERR` is not set to `SIG_IGN`, which is its default).

Calling any of these functions flushes all complete and updated records out to the system. If a repositioning operation fails, *z/OS XL C/C++* attempts to restore the original file position and treats the operation as a call to `fflush()`, except that it does not account for the presence of `ungetc()` or `ungetwc()` characters, which are lost. After a successful repositioning operation, `feof()` always returns 0, even if the position is just after the last byte of data in the file.

The `fsetpos()` and `fgetpos()` library functions are generally more efficient than `ftell()` and `fseek()`. The `fgetpos()` function can encode the current position into a structure that provides enough room to hold the system position as well as position data specific to C or C++. The `ftell()` function must encode the position into a single word of storage, which it returns. This compaction forces `fseek()` to calculate certain position information specific to C or C++ at the time of repositioning. For variable-format binary files, you can choose to have `ftell()` return relative byte offsets. In previous releases, `ftell()` returned only encoded offsets, which contained the relative block number. Since you cannot calculate the block number from a relative byte offset in a variable-format file, `fseek()` may have to read through the file to get to the new position. `fsetpos()` has system position information available within the `fpos_t` structure and can generally reposition directly to the desired location.

You can use the `ftell()` and `fseek()` functions to set the current position within all types of files except for the following:

- Files on nonseekable devices (for example, printers)
- Partitioned data sets opened in `w` or `wb` mode.

Although repositioning within files opened for write mode is not available, you can use `fgetpos()` and `ftell()` to save the current position, and this position can later be used to reposition within the same file if opened in one of the modes where reposition is allowed.

For AMODE 31 C/C++ applications, the repositioning functions can be used with large format sequential data sets under the following conditions:

- The data set contains 256 TB - 256 bytes or less.
- The data set uses 2 GB blocks or less.

## **ungetc() considerations**

For binary and text files, the library functions `fgetpos()` and `ftell()` take into account the number of characters you have pushed back onto the input stream with `ungetc()`, and adjust the file position accordingly. `ungetc()` backs up the file position by a single byte each time you call it. For text files, *z/OS XL C/C++* counts the new-lines added to the records as single-byte characters when it calculates the file position.

If you make so many calls to `ungetc()` that the logical file position is before the beginning of the file, the next call to `ftell()` or `fgetpos()` fails.



When you are using `fseek()` with a whence value of `SEEK_CUR`, the starting point for the reposition also accounts for the presence of `ungetc()` characters and compensates as `ftell()` and `fgetpos()` do.

If you want `fgetpos()` and `fseek()` to ignore `ungetc()` characters, you can set the `_EDC_COMPAT` environment variable. See Chapter 32, “Using environment variables,” on page 467 for details. `ftell()` is not affected by the setting of `_EDC_COMPAT`.

## How long `fgetpos()` and `ftell()` values last

As long as you do not re-create a file or shorten logical records, you can rely on the values returned by `ftell()` and `fgetpos()`, even across program boundaries and calls to `fclose()`. (Calling `fopen()` or `freopen()` with any of the `w` modes re-creates a file.) Using `ftell()` and `fgetpos()` values that point to information deleted or re-created results in undefined behavior. For more information about shortening records, see “Writing to variable-format text files” on page 110.

## Using `fseek()` and `ftell()` in binary files

With binary files, `ftell()` returns two types of positions:

- Relative byte offsets
- Encoded offsets

### Relative byte offsets

You get byte offsets by default when you are seeking or positioning in fixed-format binary files. You can also use byte offsets on a variable or undefined format file opened in binary mode with the `BYTESEEK` parameter specified on the `fopen()` or `freopen()` function call. You can specify `BYTESEEK` to be the default for `fopen()` calls by setting the environment variable `_EDC_BYTE_SEEK` to `Y`. See Chapter 32, “Using environment variables,” on page 467 for information on how to set environment variables.

You do not need to acquire an offset from `ftell()` to seek to a relative position; you may specify a relative offset to `fseek()` with a whence value of `SEEK_SET`. However, you cannot specify a negative offset to `fseek()` when you have specified `SEEK_SET`, because a negative offset would indicate a position before the beginning of the file. Also, you cannot specify a negative offset with whence values of `SEEK_CUR` or `SEEK_END` such that the resulting file position would be before the beginning of the file. If you specify such an offset, `fseek()` fails.

If your file is not opened read-only, you can specify a position that is beyond the current EOF. In such cases, a new end-of-file position is created; null characters are automatically added between the old EOF and the new EOF.

`fseek()` support of byte offsets in variable-format files generally requires reading all records from the whence value to the new position. The impact on performance is greatest if you open an existing file for append in `BYTESEEK` mode and then call `ftell()`. In this case, `ftell()` has to read from the beginning of the file to the current position to calculate the required byte offset. Support for byteseeeking is intended to ease portability from other platforms. If you need better performance, consider using `ftell()`-encoded offsets, see “Encoded offsets” on page 118.

For `AMODE 31` C/C++ applications repositioning within a large format sequential data set that need `fseek()` and `ftell()` to access positions beyond 2 GB - 1 byte must use the large file version of `fseeko()` and `ftello()`.



## Encoded offsets

If you do not specify the `BYTESEEK` parameter and you set the `_EDC_BYTE_SEEK` variable to `N`, any variable- or undefined-format binary file gets encoded offsets from `ftell()`. This keeps this release of z/OS XL C/C++ compatible with code generated by old releases of C/370™.

Encoded offsets are values representing the block number and the relative byte within that block, all within one `long int`. Because z/OS XL C/C++ does not document its encoding scheme, you cannot rely on any encoded offset not returned by `ftell()`, except 0, which is the beginning of the file. This includes encoded offsets that you adjust yourself (for example, with addition or subtraction). When you call `fseek()` with the whence value `SEEK_SET`, you must use either 0 or an encoded offset returned from `ftell()`. For whence values of `SEEK_CUR` and `SEEK_END`, however, you specify relative byte offsets. If you want to seek to a certain relative byte offset, you can use `SEEK_SET` with an offset of 0 to rewind the file to the beginning, and then you can use `SEEK_CUR` to specify the desired relative byte offset.

In earlier releases, `ftell()` could determine position only for files with no more than 131,071 blocks. In the new design, this number increases depending on the block size. From a maximum block size of 32,760, every time this number decreases by half, the number of blocks that can be represented doubles. Using the large file version of `ftello()` for a large format sequential data set increases the maximum number of blocks that can be represented to 2 GB in `AMODE 31 C/C++` applications.

If your file is not opened read-only, you can use `SEEK_CUR` or `SEEK_END` to specify a position that is beyond the current EOF. In such cases, a new end-of-file position is created; null characters are automatically added between the old EOF and the new EOF. This does not apply to PDS members, as they cannot be extended. For `SEEK_SET`, because you are restricted to using offsets returned by `ftell()`, any offset that indicates a position outside the current file is invalid and causes `fseek()` to fail.

## Using `fseek()` and `ftell()` in text files (ASA and Non-ASA)

In text files, `ftell()` produces only encoded offsets. It returns a `long int`, in which the block number and the byte offset within the block are encoded. You cannot rely on any encoded offset not returned by `ftell()` except 0. This includes encoded offsets that you adjust yourself (for example, with addition or subtraction).

When you call `fseek()` with the whence value `SEEK_SET`, you must use an encoded offset returned from `ftell()`. For whence values of `SEEK_CUR` and `SEEK_END`, however, you specify relative byte offsets. If you want to seek to a certain relative byte offset, you can use `SEEK_SET` with an offset of 0 to rewind the file to the beginning, and then you can use `SEEK_CUR` to specify the desired relative byte offset. z/OS XL C/C++ counts new-line characters and skips to the next record each time it reads one.

Unlike binary files you cannot specify offsets for `SEEK_CUR` and `SEEK_END` that set the file position past the end of the file. Any offset that indicates a position outside the current file is invalid and causes `fseek()` to fail.

In earlier releases, `ftell()` could determine position only for files with no more than 131071 blocks. In the new design, this number increases depending on the block size. From a maximum block size of 32760, every time this number decreases

by half, the number of blocks that can be represented doubles. Using the large file version of `ftello()` for a large format sequential data set increases the maximum number of blocks that can be represented to 2 GB in AMODE 31 C/C++ applications.

Repositioning flushes all updates before changing position. An invalid call to `fseek()` is now always treated as a flush. It flushes all updated records or all complete new records in the block, and leaves the file position unchanged. If the flush fails, any characters in the `ungetc()` buffer are lost. If a block contains an incomplete new record, the block is saved and will be completed by another write or by closing the file.

## Using `fseek()` and `ftell()` in record files

For files opened with `type=record`, `ftell()` returns relative record numbers. The behavior of `fseek()` and `ftell()` is similar to that when you use relative byte offsets for binary files, except that the unit is a record rather than a byte. For example,

```
fseek(fp,-2,SEEK_CUR);
```

seeks backward two records from the current position.

```
fseek(fp,6,SEEK_SET);
```

seeks to relative record 6. You do not need to get an offset from `ftell()`.

You cannot seek past the end or before the beginning of a file.

The first record of a file is relative record 0.

For AMODE 31 C/C++ applications repositioning within a large format sequential data set that need `fseek()` and `ftell()` to access positions beyond 2 GB - 1 record must use the large file version of `fseeko()` and `ftello()`.

## Using `fseek()` and `ftell()` in blocked files

For files opened with `type=blocked`, `ftell()` returns relative block numbers. The behavior of `fseek()` and `ftell()` is similar to that when you use relative byte offsets for binary files, except that the unit is a block rather than a byte. For example,

```
fseek(fp,-2,SEEK_CUR);
```

seeks backward two blocks from the current position.

```
fseek(fp,6,SEEK_SET);
```

seeks to relative block 6. You do not need to get an offset from `ftell()`.

You cannot seek past the end or before the beginning of a file.

The first block of a file is relative block 0.

For AMODE 31 C/C++ applications repositioning within a large format sequential data set that need `fseek()` and `ftell()` to access positions beyond 2 GB - 1 block must use the large file version of `fseeko()` and `ftello()`.

## Porting old C code that uses fseek() or ftell()

The encoding scheme used by `ftell()` in non-BYTESEEK mode in the z/OS XL C/C++ RTL is different from that used in the XL C/C++ runtime library prior to C/370 Release 2.2 and Language Environment prior to release 1.3.

- If your code obtains `ftell()` values and passes them to `fseek()`, the change to the encoding scheme should not affect your application. On the other hand, your application may not work if you have saved encoded `ftell()` values in a file and your application reads in these encoded values to pass to `fseek()`. For non-record I/O and non-blocked I/O files, you can set the environment variable `_EDC_COMPAT` with the `ftell()` encoding set to tell z/OS XL C/C++ that you have old `ftell()` values. Files opened for record I/O or blocked I/O do not support old `ftell()` values saved across the program boundary.
- In previous versions, the `fseek()` support for the `ftell()` encoding scheme inadvertently supported seeking from `SEEK_SET` with a byte offset up to 32K. This is no longer supported. Users of this support must change to `BYTESEEK` mode. You can do this without changing your source code; just use the `_EDC_BYTE_SEEK` environment variable.

---

## Closing files

Use the `fclose()` library function to close a file. z/OS XL C/C++ automatically closes files on normal program termination and attempts to do so under abnormal program termination or `abend`. See *z/OS XL C/C++ Runtime Library Reference* for more information on this library function.

For files opened in fixed binary mode, incomplete records will be padded with null characters when you close the file.

For files opened in variable binary mode, incomplete records are flushed to the system. In a spanned file, closing a file can cause a zero-length segment to be written. This segment will still be part of the non-zero-length record. For files opened in undefined binary mode, any incomplete output is flushed on close.

Closing files opened in text mode causes any incomplete new record to be completed with a new-line character. All records not yet flushed to the file are written out when the file is closed.

For files opened for record I/O, closing causes all records not yet flushed to the file to be written out.

**Note:** If an application has locked a (FILE \*) object (with `flockfile()` or `ftrylockfile()`), it is responsible for relinquishing the locked (FILE \*) object (with `funlockfile()`) before calling `fclose()`. Failure to relinquish a locked (FILE \*) object may cause deadlock or looping.

When `fclose()` is used to close a stream associated with a z/OS data set, some failures may be unrecoverable, and will result in an `ABEND`. These `ABEND`s may include I/O `ABEND`s of the form `x14` and `x37`. Control will not be returned to the caller of `fclose()` to report the error. To process these types of errors, applications need to use z/OS Language Environment condition handling to receive control (see *z/OS Language Environment Programming Guide*), or register a signal handler for `SIGABND` (see Chapter 28, "Handling error conditions, exceptions, and signals," on page 403).

If an application fails during `fclose()` with a `x37` abend, and the application would like to recover and perform any functions not related to file I/O, the following technique can be used. Refer to Figure 17 on page 122 for an example.

1. Register a signal handler for `SIGABND` and `SIGIOERR`.
2. `fopen()` the file. The `NOSEEK` option cannot be specified.
3. Manipulate the file as needed by the application.
4. When the application is done with the file, `fflush()` the file, before any `fclose()` is issued. This will ensure, if an `x37` is going to occur during `fflush()` or `fclose()` processing, that the `x37` occurs in the `fflush()`, before the `fclose()` occurs.
5. An `x37` abend occurs during `fflush()`.
6. The signal handler will receive control.
7. Once inside the signal handler, any functions not related to file I/O may be performed.

---

```

/* example of signal handler */

#include <stdio.h>
#include <stdlib.h>
#include <dynit.h>
#include <signal.h>
#include <setjmp.h>

void sighandler();
jmp_buf env;
FILE *f;

int main()
{
    int rc;
    int s=80;
    int w;
    char buff 80 ="data";
    __dyn_t ip;

    redo:
    dyninit(&ip);
    ip.__dsname="MY.DATASET";
    ip.__status=__DISP_OLD;
    ip.__ddname="NAMEDD";
    ip.__condisp=__DISP_CATLG;
    rc=dynalloc(&ip);

    f=fopen("DD:NAMEDD","wb");
    if (f==0)
    {   perror("open error");
        return 12;
    }

    signal(SIGABND,sighandler);
    signal(SIGIOERR,sighandler);

    while (1)
    {
        if (setjmp(env))
        {
            dyninit(&ip);
            ip.__ddname="NAMEDD";
            ip.__condisp=__DISP_CATLG;
            rc= dynfree(&ip);
            goto retry;
        }
        w=fwrite(buff,1,s,f);
    }

    fflush(f);
    fclose(f);

    retry:
    goto redo;
}

void sighandler() {
    fclose(f);
    longjmp(env,1);
}

```

---

*Figure 17. Example of signal handler*

**Note:** When an abend condition occurs, a write-to-programmer message about the abend is issued and your DCB abend exit is given control, provided there is an active DCB abend exit routine address in the exit list contained in the DCB being processed. If STOW called the end-of-volume routines to get secondary space to write an end-of-file mark for a PDS, or if the DCB being processed is for an indexed sequential data set, the DCB abend exit routine is not given control if an

abend condition occurs. If the situation described above is encountered, the Language Environment DCB abend exit will not receive control, and therefore the signal handler routine in an application will not receive control for the x37 abend.

---

## Renaming and removing files

You can remove or rename a z/OS data set that has an uppercase filename by using the `remove()` or `rename()` library functions, respectively. `rename()` and `remove()` both accept data set names. `rename()` does not accept ddnames, but `remove()` does. You can use `remove()` or `rename()` on individual members or entire PDSs or PDSEs. If you use `rename()` for a member, you can change only the name of the member, not the name of the entire data set. To rename both the member and the data set, make two calls to `rename()`, one for the member and one for the whole PDS or PDSE.

---

## fldata() behavior

The format of the `fldata()` function is as follows:

The `fldata()` function is used to retrieve information about an open stream. The

```
int fldata(FILE *file, char *filename, fldata_t
*info);
```

name of the file is returned in *filename* and other information is returned in the `fldata_t` structure, shown in Figure 18 on page 124. Values specific to this category of I/O are shown in the comment beside the structure element. Additional notes follow the figure. For more information on the `fldata()` function, refer to *z/OS XL C/C++ Runtime Library Reference*.

---

```

struct __fileData {
    unsigned int  __recfmF : 1, /* */
                 __recfmV : 1, /* */
                 __recfmU : 1, /* */
                 __recfmS : 1, /* */
                 __recfmBlk : 1, /* */
                 __recfmASA : 1, /* */
                 __recfmM : 1, /* */
                 __dsorgPO : 1, /* */
                 __dsorgPDSmem : 1, /* */
                 __dsorgPDSdir : 1, /* */
                 __dsorgPS : 1, /* */
                 __dsorgConcat : 1, /* */
                 __dsorgMem : 1, /* N/A -- always off */
                 __dsorgHiper : 1, /* N/A -- always off */
                 __dsorgTemp : 1, /* */
                 __dsorgVSAM : 1, /* N/A -- always off */
                 __dsorgHFS : 1, /* N/A -- always off */
                 __openmode : 2, /* one of: */
                        /* __TEXT */
                        /* __BINARY */
                        /* __RECORD */
                 __modeflag : 4, /* combination of: */
                        /* __READ */
                        /* __WRITE */
                        /* __APPEND */
                        /* __UPDATE */
                 __dsorgPDSE : 1, /* N/A -- always off */
                 __vsamRLS : 3, /* N/A */
#ifdef __EDC_TARGET >= 0x41080000
                 __vsamEA : 1, /* */
                 __recfmB : 1, /* */
                 __reserve2 : 3; /* */
#else
                 __reserve3 : 5; /* */
#endif
    __device_t  __device; /* one of: */
                        /* __DISK */
                        /* __TAPE */
                        /* __PRINTER */
                        /* __DUMMY */
                        /* __OTHER */
    unsigned long  __blksize, /* */
                  __maxreclen; /* */
    union {
        struct {
            unsigned short  __vsam_type; /* N/A */
            unsigned long  __vsam_keylen; /* N/A */
            unsigned long  __vsam_RKP; /* N/A */
        } __vsam; /* */
        struct {
            unsigned short  __disk_vsam_type; /* */
            unsigned char  __disk_access_method; /* */
            unsigned char  __disk_noseek_to_seek; /* */
            long  __disk_reserve[2]; /* */
        } __disk; /* */
    } __device_specific; /* */
    char *  __dsname; /* */
    unsigned int  __reserve4; /* */
};
typedef struct __fileData fldata_t;

```

---

Figure 18. *fldata()* Structure

**Notes:**

1. If you have opened the file by its data set name, *filename* is fully qualified, including quotation marks. If you have opened the file by ddname, *filename* is

dd:ddname, without any quotation marks. The ddname is uppercase. If you specified a member on the fopen() or freopen() function call, the member is returned as part of filename.

2. Any of the \_\_recfm bits may be set on for OS files.
3. The \_\_dsorgP0 bit will be set on only if you are reading a directory or member of a partitioned data set, either regular or extended, regardless of whether the member is specified on a DD statement or on the fopen() or freopen() function call. The \_\_dsorgPS bit will be set on for all other OS files.
4. The \_\_dsorgPDSE bit will be set when processing an extended partitioned data set (PDSE).
5. The \_\_dsorgConcat bit will be set on for a concatenation of sequential data sets, but not for a concatenation of partitioned data sets.
6. The \_\_dsorgTemp bit will be set on only if the file was created using the tmpfile() function.
7. The \_\_blksize value may include BDW and RDWs.
8. The \_\_maxreclen value may include the ASA character.
9. The \_\_recfm bits and the \_\_blksize and \_\_maxreclen values correspond to the attributes of the open stream. They do not necessarily reflect the attributes of the existing data set.
10. The \_\_dsname field is filled in for **\_\_DISK** files with the data set name. The member name is added if the file is a member of a partitioned data set, either regular or extended. The \_\_dsname value is uppercase unless the asis option was specified on the fopen() or freopen() function call. The \_\_dsname field is set to NULL for all other OS files.





---

## Chapter 11. Performing z/OS UNIX file system I/O operations

You can create the following file types in the z/OS UNIX file system:

- Regular
- Link
- Directory
- Character special
- FIFO

The Single UNIX Specification defines another type of file called STREAMS. Even though the system interfaces are provided, it is impossible to have a valid STREAMS file descriptor. These interfaces will always return a return code of -1 with errno set to indicate an error such as, EBADF, EINVAL, or ENOTTY.

z/OS UNIX file system streams follow the binary model, regardless of whether they are opened for text, binary, or record I/O. You can simulate record I/O by using new-line characters as record boundaries.

For information on the z/OS UNIX file system and access to files within it from other than the C or C++ language, see *z/OS V2R2.0 UNIX System Services User's Guide*. For an introduction to and description of the behavior of a POSIX-defined file system, see Zlotnick, Fred, *The POSIX.1 Standard: A Programmer's Guide*, Redwood City, CA: The Benjamin/Cummings Publishing Company, Inc., 1991.

This topic describes C I/O stream functions as they can be used within C++ programs. If you want to use the C++ I/O stream classes instead, see Chapter 4, "Using the Standard C++ Library I/O Stream Classes," on page 23. For more detailed information, see *Standard C++ Library Reference*. For information about using wide-character I/O with z/OS XL C/C++, see Chapter 8, "z/OS XL C Support for the double-byte character set," on page 53.

---

### Creating files

You can use library functions to create the following types of z/OS UNIX file system files.

- Regular Files
- Link and Symbolic Link Files
- Directory Files
- Character Special Files
- FIFO Files

#### Regular files

Use any of the following C functions to create regular files in the z/OS UNIX file system:

- `creat()`
- `fopen()`
- `freopen()`
- `open()`

For a description of these and other I/O functions, see *z/OS XL C/C++ Runtime Library Reference*.

## Link and symbolic link files

Use either of the following C functions to create z/OS UNIX file system link or symbolic link files:

- `link()`
- `symlink()`

## Directory files

Use the `mkdir()` C function to create a z/OS UNIX file system directory file.

## Character special files

Use the `mknod()` C function to create a character special file in the z/OS UNIX file system; you must have superuser authority to create a character special file.

Other functions used for character special files are:

- `ptsname()`
- `grantpt()`
- `unlockpt()`
- `tcgetsid()`
- `ttyname()`
- `isatty()`

## FIFO files

Use the `mkfifo()` C function to create a FIFO file (named pipe) in the z/OS UNIX file system.

To create an unnamed pipe, use the `pipe()` C function.

---

## Opening files

This section discusses the use of the `fopen()` or `freopen()` library functions to open z/OS UNIX file system I/O files. You can also access z/OS UNIX file system files using low-level I/O `open()` function. See “Low-level z/OS UNIX I/O” on page 141 for information about low-level I/O, and *z/OS XL C/C++ Runtime Library Reference* for information about any of the functions listed above.

The name of a z/OS UNIX file system file can include characters chosen from the complete set of character values, except for null characters. If you want a portable filename, then choose characters from the POSIX .1 portable filename character set.

The complete *pathname* can begin with a slash and be followed by zero, one, or more filenames, each separated by a slash. If a directory is included within the pathname, it may have one or more trailing slashes. Multiple slashes following one another are interpreted as one slash.

If your program is running under `POSIX(0N)`, all valid POSIX names are passed with the `as is` `fopen()` parameter to the POSIX `open()` function.

You can access either z/OS UNIX file system files or MVS data sets from programs. Programs accessing files or data sets can be executed with either the

POSIX(OFF) or POSIX(ON) runtime options. There are basic file naming rules that apply for z/OS UNIX file system files and MVS data sets. However, there are also special z/OS XL C/C++ naming considerations that depend on how you execute your program.

The POSIX runtime option determines the type of z/OS XL C/C++ services and I/O available to your program. (See *z/OS XL C/C++ User's Guide* for a discussion of the z/OS UNIX programming environment and overview of binding z/OS UNIX XL C/C++ applications.)

Both the basic and special z/OS XL C/C++ file naming rules for z/OS UNIX file system files are described in the sections that follow. Examples are provided. All examples must be run with the POSIX(ON) option. For information about MVS data sets, see Chapter 10, "Performing OS I/O operations," on page 83.

## Using fopen() or freopen()

When you open a file with `fopen()` or `freopen()`, you must specify the data set name, file name, or `ddname`.

### File naming considerations

Files are opened with a call to `fopen()` or `freopen()` in the format `fopen("filename", "mode")`.

**z/OS UNIX file system files:** The following is the format for the *pathname* argument on the `fopen()` or `freopen()` function:

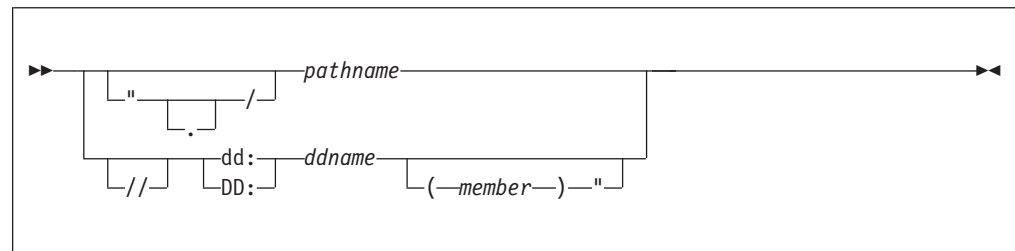

The POSIX.1 standard defines *pathname* as the information that identifies a file. For the z/OS UNIX implementation of the POSIX.1 standard, a *pathname* can be up to 1024 characters—including the null-terminating character. Optionally, it can begin with a slash character (/) followed by directory names separated by slash characters and a filename. For the *pathname*, each directory name or the filename can be up to 255 characters long.

**Note:** Regardless of whether your program is run under z/OS UNIX or as a traditional MVS application, if the *pathname* that you attempt to open using `fopen()` or `freopen()` contains a slash character but does not begin with exactly two slashes, a z/OS UNIX file system file is opened. For example, if you code:

```
fopen("tradnsell/parts.order", "w+")
```

the file `tradnsell/parts.order` from the working directory is opened.

If you begin the *pathname* value with `./`, the specified file in the working directory is opened:

```
fopen("./parts.order", "w+")
```

Likewise, if you begin the *pathname* value with */*, the specified file in the root directory is opened:

```
fopen("/parts.order", "w+")
```

If you specify more than two consecutive slash characters anywhere in a *pathname*, all but the first slash character is ignored, as in the following examples:

```
"//a.b"
    MVS data set prefix.a.b

"///a.b"
    z/OS UNIX file system file /a.b

"////a.b"
    z/OS UNIX file system file /a.b

"a///b.c"
    z/OS UNIX file system file a/b.c

"/a.b" z/OS UNIX file system file /a.b

"/a///b.c"
    z/OS UNIX file system file /a/b.c
```

If you specify */dd:pathname* or *./dd:pathname*, a file named *dd:pathname* is opened in the file system root directory or your working directory, respectively. For example, if you code the following statement, the file *dd:parder* is opened in the root directory.

```
fopen("/dd:parder", "w+")
```

For z/OS UNIX file system files, leading and trailing white spaces are *significant*.

## Opening a file by name

Which type of file (z/OS UNIX file system or MVS data set) you open may depend on whether the z/OS XL C/C++ application program is running under POSIX(ON).

For an application program that is to be run under POSIX(ON), you can include in your program statements similar to the following to open the file *parts.instock* for reading in the working directory:

```
FILE *stream;

stream = fopen("parts.instock", "r");
```

To open the MVS data set *user-prefix.PARTS.INSTOCK* for reading, include statements similar to the following in your program:

```
FILE *stream;

stream = fopen("//parts.instock", "r");
```

For an application program that is to be run as a traditional z/OS XL C/C++ application program, with POSIX(OFF), to open the MVS data set *user-prefix.PARTS.INSTOCK* for reading, include statements similar to the following in your program:

```
FILE *stream;

stream = fopen("parts.instock", "r");
```

To open the file `parts.instock` in the working directory for reading, include statements similar to the following in your program:

```
FILE *stream;

stream = fopen("./parts.instock", "r");
```

## Opening a file by DDname

The DD statement enables you to write z/OS XL C/C++ source programs that are independent of the files and I/O devices they will use. You can modify the parameters of a file or process different files without recompiling your program.

When `//dd:ddname` is specified to `fopen()` or `freopen()`, the z/OS XL C/C++ library looks to find and resolve the data definition information for the filename to open. If the data definition information points to an MVS data set, MVS data set naming rules are followed. If a z/OS UNIX file system file is indicated using the `PATH` parameter on the data definition statement, a `ddname` is resolved to the associated pathname.

**Note:** Use of the z/OS XL C/C++ `fork()` library function from an application program under z/OS UNIX does not replicate the data definition information of the parent process in the child process. Use of any of the `exec()` library functions deallocates the data definition information for the application process.

For the declaration just shown for the file `parts.instock`, you should write a JCL DD statement similar to the following:

```
//PSTOCK DD PATH='/u/parts.instock',...
```

For more information on writing DD statements, you should refer to the job control language (JCL) manual *z/OS MVS JCL Reference*.

To open the file by DD name under TSO/E, you must write an `ALLOCATE` command. For the declaration of a file `parts.instock`, you should write a TSO/E `ALLOCATE` command similar to the following:

```
ALLOCATE DDNAME(PSTOCK) PATH('/u/parts.instock')...
```

See *z/OS TSO/E Command Reference* for more information on TSO `ALLOCATE`.

## fopen() and freopen() parameters

The following table lists the parameters that are available on the `fopen()` and `freopen()` functions, tells you which ones are useful for z/OS UNIX file system I/O, and lists the values that are valid for the applicable ones.

Table 24. Parameters for the `fopen()` and `freopen()` functions for z/OS UNIX file system I/O

Parameter	Allowed?	Applicable?	Notes
<code>recfm=</code>	Yes	No	z/OS UNIX file system I/O uses a continuous stream of data as its file format.
<code>lrecl=</code>	Yes	No	z/OS UNIX file system I/O uses a continuous stream of data as its file format.
<code>blksize=</code>	Yes	No	z/OS UNIX file system I/O uses a continuous stream of data as its file format.
<code>space=</code>	Yes	No	Not used for z/OS UNIX file system I/O.
<code>type=</code>	Yes	Yes	May be omitted. If you do specify it, <code>type=record</code> is the only valid value.
<code>acc=</code>	Yes	No	Not used for z/OS UNIX file system I/O.

Table 24. Parameters for the `fopen()` and `freopen()` functions for z/OS UNIX file system I/O (continued)

Parameter	Allowed?	Applicable?	Notes
<code>password=</code>	Yes	No	Not used for z/OS UNIX file system I/O.
<code>asis</code>	Yes	No	Not used for z/OS UNIX file system I/O.
<code>byteseek</code>	Yes	No	Not used for z/OS UNIX file system I/O.
<code>noseek</code>	Yes	No	Not used for z/OS UNIX file system I/O.
<code>OS</code>	Yes	No	Not used for z/OS UNIX file system I/O.
<code>abend=</code>	Yes	No	Not used for z/OS UNIX file system I/O.

**recfm=**

Ignored for z/OS UNIX file system I/O.

**lrecl= and blksize=**

Ignored for z/OS UNIX file system I/O, except that `lrecl` affects the value returned in the `__maxreclen` field of `fldata()` as described below.

**acc=**

Ignored for z/OS UNIX file system I/O.

**password**

Ignored for z/OS UNIX file system I/O.

**space=**

Ignored for z/OS UNIX file system I/O.

**type=**

The only valid value for this parameter under the z/OS UNIX file system is `type=record`. If you specify this, your file follows the z/OS UNIX file system record I/O rules:

1. One record is defined to be the data up to the next new-line character.
2. When an `fread()` is done the data will be copied into the user buffer as if an `fgets(buf, size_item*num_items, stream)` were issued. Data is read into the user buffer *up to* the number of bytes specified on the `fread()`, or until a new-line character or EOF is found. The new-line character is not included.
3. When an `fwrite()` is done the data will be written from the user buffer with a new-line character added by the RTL code. Data is written up to the number of bytes specified on the `fwrite()`; the new-line is added by the RTL and is not included in the return value from `fwrite()`.
4. If you have specified an `lrecl` and `type=record`, `fldata()` of this stream will return the `lrecl` you specified, in the `__maxreclen` field of the `__fileData` return structure of `stdio.h`. If you specified `type=record` but no `lrecl`, the `__maxreclen` field will contain 1024.

If `type=record` is not in effect, a call to `fldata()` of this stream will return 0 in the `__maxreclen` field of the `__fileData` return structure of `stdio.h`.

**asis**

Ignored for z/OS UNIX file system I/O.

**byteseek**

Ignored for z/OS UNIX file system I/O.

**noseek**

Ignored for z/OS UNIX file system I/O.

**OS** Ignored for z/OS UNIX file system I/O.

**abend=**

Ignored for z/OS UNIX file system I/O.

---

## Reading from z/OS UNIX file system files

You can use the following library functions to read in information from z/OS UNIX file system files:

- `fread()`
- `fread_unlocked()`
- `fgets()`
- `fgets_unlocked()`
- `gets()`
- `gets_unlocked()`
- `fgetc()`
- `fgetc_unlocked()`
- `getc()`
- `getc_unlocked()`
- `getchar()`
- `getchar_unlocked()`
- `scanf()`
- `scanf_unlocked()`
- `fscanf()`
- `fscanf_unlocked()`
- `read()`
- `pread()`
- `vscanf()`
- `vscanf_unlocked()`
- `vfscanf()`
- `vfscanf_unlocked()`

`fread()` is the only interface allowed for reading record I/O files. See *z/OS XL C/C++ Runtime Library Reference* for more information on all of the above library functions.

For z/OS UNIX low-level I/O, you can use the `read()` and `readv()` function. See “Low-level z/OS UNIX I/O” on page 141.

---

## Opening and reading from z/OS UNIX file system directory files

To open a z/OS UNIX file system directory, you can use the `opendir()` function.

You can use the following library functions to read from, and position within, z/OS UNIX file system directories:

- `readdir()`
- `seekdir()`
- `telldir()`

To close a directory, use the `closedir()` function.



---

## Writing to z/OS UNIX file system files

You can use the following library functions to write to z/OS UNIX file system files:

- `fwrite()`
- `fwrite_unlocked()`
- `printf()`
- `printf_unlocked()`
- `fprintf()`
- `fprintf_unlocked()`
- `vprintf()`
- `vprintf_unlocked()`
- `fprintf()`
- `fprintf_unlocked()`
- `puts()`
- `puts_unlocked()`
- `fputs()`
- `fputs_unlocked()`
- `fputc()`
- `fputc_unlocked()`
- `putc()`
- `putc_unlocked()`
- `putchar()`
- `putchar_unlocked()`
- `write()`
- `pwrite()`

`fwrite()` is the only interface allowed for writing to record I/O files. See *z/OS XL C/C++ Runtime Library Reference* for more information on all of the above library functions. For z/OS UNIX low-level I/O, you can use the `write()` and `writev()` function.

---

## Flushing records

You can use the library function `fflush()` to flush streams to the system. For more information about `fflush()`, see *z/OS XL C/C++ Runtime Library Reference*.

The action taken by the `fflush()` library function depends on the buffering mode associated with the stream and the type of streams. If you call one z/OS XL C/C++ program from another z/OS XL C/C++ program by using the ANSI `system()` function, all open streams are flushed before control is passed to the callee, and again before control is returned to the caller. A call to the POSIX `system()` function does not flush any streams.

For z/OS UNIX file system files, the `fflush()` function copies the data from the runtime buffer to the file system. The `fsync()` function copies the data from the file system buffer to the storage device.

---

## Setting positions within files

You can use the following library functions to help you reposition within a regular file:

- `fseek()`
- `fseek_unlocked()`
- `fseeko()`
- `fseeko_unlocked()`

- `ftell()`
- `ftell_unlocked()`
- `ftello()`
- `ftello_unlocked()`
- `fgetpos()`
- `fgetpos_unlocked()`
- `fsetpos()`
- `fsetpos_unlocked()`
- `lseek()`
- `rewind()`
- `rewind_unlocked()`

With large file support enabled for AMODE 31 C/C++ applications, you can use the following library functions for 64-bit offsets:

- `fseeko()`
- `fseeko_unlocked()`
- `ftello()`
- `ftello_unlocked()`
- `lseek()`

For AMODE 64 C/C++ applications, large files are automatically supported in the LP64 programming model. All of the above functions (both lists) can be used with 64-bit offsets.

See *z/OS XL C/C++ Runtime Library Reference* for more information on these library functions.

---

## Closing files

You can use `fclose()`, `freopen()`, or `close()` to close a file. z/OS XL C/C++ automatically closes files on normal program termination, and attempts to do so under abnormal program termination or `abend`. See *z/OS XL C/C++ Runtime Library Reference* for more information on these library functions. For z/OS UNIX low-level I/O, you can use the `close()` function. When you use any `exec()` or `fork()` function, files defined as “marked to be closed” are closed before control is returned.

---

## Deleting files

Use the `unlink()` or `remove()` z/OS XL C/C++ function to delete the following types of z/OS UNIX file system files:

- Regular
- Character special
- FIFO
- Link files

Use the `rmdir()` z/OS XL C/C++ function to delete a z/OS UNIX file system directory file. See *z/OS XL C/C++ Runtime Library Reference* for more information about these functions.

---

## Pipe I/O

POSIX.1 pipes represent an I/O channel that processes can use to communicate with other processes. Pipes are conceptually like z/OS UNIX file system files. One process can write data into a pipe, and another process can read data from the pipe.

z/OS UNIX XL C/C++ supports two types of POSIX.1-defined pipes: unnamed pipes and named pipes (FIFO files).

An *unnamed pipe* is accessible only by the process that created the pipe and its child processes. An unnamed pipe does not have to be opened before it can be used. It is a temporary file that lasts only until the last file descriptor that references it is closed. You can create an unnamed pipe by calling the `pipe()` function.

A *named pipe* can be used by independent processes and must be explicitly opened and closed. Named pipes are also referred to as first-in, first-out (FIFO) files, or FIFOs. You can create a named pipe by calling the `mkfifo()` function. If you want to stream I/O after a `pipe()` function, call the `fdopen()` function to build a stream on one of the file descriptors returned by `pipe()`. If you want to stream I/O on a FIFO file, open the file with `fdopen()` together with one of `fopen()`, `freopen()`, or `open()`. When the stream is built, you can then use Standard C I/O functions, such as `fgetc()` or `printf()`, to carry out input and output.

### Using unnamed pipes

If your z/OS UNIX XL C/C++ application program forks processes that need to communicate among themselves for work to be done, you can take advantage of POSIX.1-defined unnamed pipes. If your application program's processes need to communicate with other processes that it did not fork, you should use the POSIX.1-defined named pipe (FIFO special file) support. See "Using named pipes" on page 137 for more information.

When you code the `pipe()` function to create a pipe, you pass a pointer to a two-element integer array where `pipe()` puts the file descriptors it creates. One descriptor is for the input end of the pipe, and the other is for the output end of the pipe. You can code your application so that one process writes data to the input end of the pipe and another process reads from the output end on a first-in-first-out basis. You can also build a stream on the pipe by using `fdopen()`, and use buffered I/O functions. The result is that you can communicate data between a parent process and any of its child processes.

The opened pipe is assigned the two lowest-numbered file descriptors available.

z/OS UNIX provides no security checks for unnamed pipes, because such a pipe is accessible only by the parent process that creates the pipe and any of the parent process's descendent processes. When the parent process ends, an unnamed pipe created by the process can still be used, if needed, by any existing descendant process that has an open file descriptor for the pipe.

Consider the sample program (CCNGHF1) in Figure 19 on page 137. In this example, where you open a pipe, do a write operation, and later do a read operation from the pipe. For more information on the `pipe()` function and the file I/O functions, see *z/OS XL C/C++ Runtime Library Reference*.

---

```

/* this example shows how unnamed pipes may be used */

#include <unistd.h>
#include <stdio.h>
#include <errno.h>

int main() {
int ret_val;
int pfd[2];
char buff[32];
char string1[]="String for pipe I/O";

ret_val = pipe(pfd);          /* Create pipe */
if (ret_val != 0) {          /* Test for success */
printf("Unable to create a pipe; errno=%d\n",errno);

exit(1);                    /* Print error message and exit */
}
if (fork() == 0) {
/* child program */
close(pfd[0]); /* close the read end */
ret_val = write(pfd[1],string1,strlen(string1)); /*Write to pipe*/
if (ret_val != strlen(string1)) {
printf("Write did not return expected value\n");
exit(2);                /* Print error message and exit */
}
}
else {
/* parent program */
close(pfd[1]); /* close the write end of pipe */
ret_val = read(pfd[0],buff,strlen(string1)); /* Read from pipe */
if (ret_val != strlen(string1)) {
printf("Read did not return expected value\n");
exit(3);                /* Print error message and exit */
}
printf("parent read %s from the child program\n",buff);
}
exit(0);
}

```

---

Figure 19. Unnamed pipes example

## Using named pipes

If the z/OS UNIX XL C/C++ application program you are developing requires its active processes to communicate with other processes that are active but may not be from the same program, code your application program to create a *named pipe* (FIFO *file*). Named pipes allow transfer of data between processes in a FIFO manner and synchronization of process execution. Use of a named pipe allows processes to communicate even though they do not know what processes are on the other end of the pipe. Named pipes differ from standard unnamed pipes, created using the `pipe()` function, in that they involve the creation of a real file that is available for I/O operations to properly authorized processes.

Within the application program, you create a named pipe by coding a `mkfifo()` or `mknod()` function. You give the FIFO a name and an access mode when you create it. If the access mode allows all users read and write access to the named pipe, any process that knows its name can use it to send or receive data.

Processes can use the `open()` function to access named pipes and then use the regular I/O functions for files, such as `read()`, `write()`, and `close()`, when manipulating named pipes. Buffered I/O functions can also be used to access and

manipulate named pipes. For more information on the `mkfifo()` and `mknod()` functions and the file I/O functions, see *z/OS XL C/C++ Runtime Library Reference*.

**Restriction:** If `fopen()` is used to open named pipes in a multi-threaded environment, a deadlock will occur. This deadlock is caused by a named pipe waiting for the other end of the pipe to be opened, while still holding the `fopen()` multi-thread mutex. To prevent this deadlock, use `open()` to open the named pipe, instead of `fopen()`.

z/OS UNIX does security checks on named pipes.

The following steps outline how to use a named pipe from z/OS UNIX XL C/C++ application programs:

1. Create a named pipe using the `mkfifo()` function. Only one of the processes that use the named pipe needs to do this.
2. Access the named pipe using the appropriate I/O method.
3. Communicate through the pipe with another process using file I/O functions:
  - a. Write data to the named pipe.
  - b. Read data from the named pipe.
4. Close the named pipe.
5. If the process created the named pipe and the named pipe is no longer needed, remove that named pipe using the `unlink()` function.

A process running the following simple example program creates a new named pipe with the file pathname pointed to by the `path` value coded in the `mkfifo()` function. The access mode of the new named pipe is initialized from the `mode` value coded in the `mkfifo()` function. The file permission bits of the `mode` argument are modified by the process file creation mask.

As an example, a process running the program code (CCNGHF2) in Figure 20 on page 139 creates a child process and then creates a named pipe called `fifo.test`. The child process then writes a data string to the pipe file. The parent process reads from the pipe file and verifies that the data string it reads is the expected one.

**Note:** The two processes are related and have agreed to communicate through the named pipe. They need not be related, however. Other authorized users can run the same program and participate in (or interfere with) the process communication.

```

/* this example shows how named pipes may be used */
#define _OPEN_SYS
#include <stdio.h>
#include <unistd.h>
#include <errno.h>
#include <fcntl.h>
#include <sys/wait.h>
/*
 * Sample use of mkfifo()
 */

main()

{
    /* start of program */

    int    flags, ret_value, c_status;
    pid_t  pid;
    size_t n_elements;
    char   char_ptr[32];
    char   str[] = "string for fifo ";
    char   fifoname[] = "temp.fifo";
    FILE   *rd_stream,*wr_stream;

    if ((mkfifo(fifoname,S_IRWXU)) != 0) {
        printf("Unable to create a fifo; errno=%d\n",errno);
        exit(1);
        /* Print error message and return */
    }

    if ((pid = fork()) < 0) {
        perror("fork failed");
        exit(2);
    }

    if (pid == (pid_t)0) {
        /* CHILD process */
        /* issue fopen for write end of the fifo */
        wr_stream = fopen(fifoname,"w");
        if (wr_stream == (FILE *) NULL) {
            printf("In child process\n");
            printf("fopen returned a NULL, expected valid stream\n");
            exit(100);
        }

        /* perform a write */
        n_elements = fwrite(str,1,strlen(str),wr_stream);
        if (n_elements != (size_t) strlen(str)) {
            printf("Fwrite returned %d, expected %d\n",
                (int)n_elements,strlen(str));
            exit(101);
        }
        exit(0);
        /* return success to parent */
    }

    else {
        /* PARENT process */

        /* issue fopen for read */
        rd_stream = fopen(fifoname,"r");
        if (rd_stream == (FILE *) NULL) {
            printf("In parent process\n");
            printf("fopen returned a NULL, expected valid pointer\n");
            exit(2);
        }
    }
}

```

### *Named pipes example (Part 1 of 2)*

*Figure 20. Named pipes example*

```

/* get current flag settings of file */
if ((flags = fcntl(fileno(rd_stream),F_GETFL)) == -1) {
    printf("fcntl returned -1 for %s\n",fifoname);
    exit(3);
}

/* clear O_NONBLOCK and reset file flags */
flags &= (O_NONBLOCK);
if ((fcntl(fileno(rd_stream),F_SETFL,flags)) == -1) {
    printf("\nfcntl returned -1 for %s",fifoname);
    exit(4);
}

/* try to read the string */
ret_value = fread(char_ptr,sizeof(char),strlen(str),rd_stream);
if (ret_value != strlen(str)) {
    printf("\nFread did not read %d elements as expected ",
        strlen(str));
    printf("\nret_value is %d ",ret_value);
    exit(6);
}

if (strcmp(char_ptr,str,strlen(str))) {
    printf("\ncontents of char_ptr are %s ",
        char_ptr);
    printf("\ncontents of str are %s ",
        str);
    printf("\nThese should be equal");
    exit(7);
}

ret_value = fclose(rd_stream);
if (ret_value != 0) {
    printf("\nFclose failed for %s",fifoname);
    printf("\nerrno is %d",errno);
    exit(8);
}
ret_value = remove(fifoname);
if (ret_value != 0) {
    printf("\nremove failed for %s",fifoname);
    printf("\nerrno is %d",errno);
    exit(9);
}

pid = wait(c_status);
if ((WIFEXITED(c_status) !=0) && (WEXITSTATUS(c_status) !=0)) {
    printf("\nchild exited with code %d",WEXITSTATUS(c_status));
    exit(10);
}
} /* end of else clause */
printf("About to issue exit(0), \
    processing completed successfully\n");
exit(0);
}

```

*Named pipes example (Part 2 of 2)*

## Character special file I/O

A named pipe (FIFO file) is a type of character special file. Therefore, it obeys the I/O rules for character special files rather than the rules for regular files:

- It cannot be opened in read/write mode. A process must open a named pipe in either write-only or read-only mode.

- It must be opened in read mode by a process before it can be opened in write mode by another process. Otherwise, the file is blocked from use for I/O by processes. Blocked processes can cause an application program to hang.  
A single process intending to access a named pipe can use an `open()` function with `O_NONBLOCK` to open the read end of the named pipe. It can then open the named pipe in write mode.

**Note:** The `fopen()` function cannot be used to accomplish this.

---

## Low-level z/OS UNIX I/O

Low-level z/OS UNIX I/O is the POSIX.1-defined I/O method. All input and output is processed using the defined `read()`, `readv()`, `write()`, and `writv()` functions.

For application programmers used to a UNIX environment, z/OS UNIX behaves in familiar and predictable ways. Standard UNIX programming practices for shared resources, along with designing applications to respect locks put on files by multiple threads running in a process, will ensure that data is handled predictably.

For a discussion of POSIX.1-defined low-level I/O and some of the practical considerations to take into account when designing an application, see *The POSIX.1 Standard: A Programmer's Guide*, by Fred Zlotnick (Redwood City, CA: The Benjamin/Cummings Publishing Company, Inc., 1991).

---

## Example of z/OS UNIX file system I/O functions

This section contains examples that demonstrate different uses of z/OS UNIX I/O file system functions

Figure 21 on page 142 is example code (CCNGHF3) that demonstrates the use of z/OS UNIX stream input/output by writing streams to a file, reading the input lines, and replacing a line.



```

/* this example uses HFS stream I/O */

#define _OPEN_SYS
#include <stdlib.h>
#include <string.h>
#include <stdio.h>
#include <unistd.h>
#include <fcntl.h>
#include <sys/types.h>
#undef _OPEN_SYS
FILE *stream;

char string1[] = "A line of text."; /* NOTE: There are actually 16 */
char string2[] = "Find this line."; /* characters in each line of */
char string3[] = "Another stream."; /* text. The 16th is a null */
char string4[16]; /* terminator on each string. */
long position, strpos; /* Since the null character */
int i, result, fd; /* is not being written to */
int rc; /* the file, 15 is used as */
/* the data stream length. */

ssize_t x;
char buffer[16];

```

*Example of z/OS UNIX stream input and output functions (Part 1 of 3)*

*Figure 21. Example of z/OS UNIX stream input and output functions*

```

int main(void)
{
    /* Write continuous streams to file */

    if ((stream = fopen("./myfile.data","wb"))==NULL) {
        perror("Error opening file");
        exit(0);
    }

    for(i=0; i<12;i++) {
        int len1 = strlen(string1);
        rc = fwrite(string1, 1, len1, stream);
        if (rc != len1) {
            perror("fwrite failed");
            printf("i = %d\n", i);
            exit(99);
        }
    }
    rc = fwrite(string2,1,sizeof(string2)-1,stream);

    if (rc != sizeof(string2)-1) {
        perror("fwrite failed");
        exit(99);
    }

    for(i=0;i<12;i++) {
        rc = fwrite(string1,1,sizeof(string1)-1,stream);

        if (rc != sizeof(string1)-1) {
            perror("fwrite failed");
            printf("i = %d\n", i);
            exit(99);
        }
    }
    fclose(stream);
    /* Read data stream and search for location of string2.      */
    /* EOF is not set until an attempt is made to read past the */
    /* end-of-file, thus the fread is at the end of the while loop */

    stream = fopen("./myfile.data", "rb");

    if ((position = ftell(stream)) == -1L)
        perror("Error saving file position.");
    rc = fread(string4, 1, sizeof(string2)-1, stream);

```

*Example of z/OS UNIX stream input and output functions (Part 2 of 3)*

```

while(!feof(stream)) {
    if (rc != sizeof(string2)-1) {
        perror("fread failed");
        exit(99);
    }

    if (strstr(string4,string2) != NULL) /* If string2 is found */
        strpos = position; /* then save position. */

    if ((position=ftell(stream)) == -1L)
        perror("Error saving file position.");
    rc = fread(string4, 1, sizeof(string2)-1, stream);
}

fclose(stream);
/* Replace line containing string2 with string3 */

fd = open("test.data",O_RDWR);

if (fd < 0){
    perror("open failed\n");
}

x = write(fd,"a record",8);

if (x < 8){
    perror("write failed\n");
}

rc = lseek(fd,0,SEEK_SET);
x = read(fd,buffer,8);

if (x < 8){
    perror("read failed\n");
}
printf("data read is %.8s\n",buffer);

close(fd);
}

```

*Example of z/OS UNIX stream input and output functions (Part 3 of 3)*

To use 64-bit offset and file sizes, you must make the following changes in your code:

1. Change any variables used for offsets in `fseek()` or `ftell()` that are `int` or `long` to the `off_t` data type.
2. Define the `_LARGE_FILES` 1 feature test macro.
3. Replace `fseek()/ftell()` with `fseeko()/ftello()`. See *z/OS XL C/C++ Runtime Library Reference* for descriptions of these functions.
4. Compile with the `LANGLV(LONGLONG)` compiler option.

**Notes:**

1. These changes are compatible with your older files.
2. Large Files support (64-bit offset and file sizes) is automatic in the LP64 programming model that is used in 64-bit. The `long` data type is widened to 64-bits. This enables `fseek()` and `ftell()` to work with the larger offsets with no code change. The `fseeko()` and `ftello()` functions also work with 64-bit offsets since `off_t` is typedef'd as a long int.

The example program (CCNGHF4) in Figure 22 on page 146 provides the same function as CCNGHF3, but it uses 64-bit offsets. The changed lines are marked in a **bold** font.

```

/* this example uses HFS stream I/O and 64-bit offsets*/

#define _OPEN_SYS
#define _LARGE_FILES 1
#include <stdlib.h>
#include <string.h>
#include <stdio.h>
#include <unistd.h>
#include <fcntl.h>
#include <sys/types.h>
#undef _OPEN_SYS
FILE *stream;

char string1[] = "A line of text."; /* NOTE: There are actually 16 */
char string2[] = "Find this line."; /* characters in each line of */
char string3[] = "Another stream."; /* text. The 16th is a null */
char string4[16]; /* terminator on each string. */
off_t position, strpos; /* Since the null character */
int i, result, fd; /* is not being written to */
int rc; /* the file, 15 is used as */
/* the data stream length. */

ssize_t x;
char buffer[16];

int main(void)
{
    /* Write continuous streams to file */

    if ((stream = fopen("./myfile.data", "wb")) == NULL) {
        perror("Error opening file");
        exit(0);
    }

    for(i=0; i<12; i++) {
        int len1 = strlen(string1);
        rc = fwrite(string1, 1, len1, stream);
        if (rc != len1) {
            perror("fwrite failed");
            printf("i = %d\n", i);
            exit(99);
        }
    }
    rc = fwrite(string2, 1, sizeof(string2)-1, stream);

    if (rc != sizeof(string2)-1) {
        perror("fwrite failed");
        exit(99);
    }

    for(i=0; i<12; i++) {
        rc = fwrite(string1, 1, sizeof(string1)-1, stream);

        if (rc != sizeof(string1)-1) {
            perror("fwrite failed");
            printf("i = %d\n", i);
            exit(99);
        }
    }
}

```

*Example of HFS stream input and output functions (Part 1 of 2)*

*Figure 22. Example of HFS stream input and output functions*

```

fclose(stream);
/* Read data stream and search for location of string2.      */
/* EOF is not set until an attempt is made to read past the */
/* end-of-file, thus the fread is at the end of the while loop */

stream = fopen("./myfile.data", "rb");

if ((position=ftello(stream)) == -1LL)
    perror("Error saving file position.");

rc = fread(string4, 1, sizeof(string2)-1, stream);

while(!feof(stream)) {
    if (rc != sizeof(string2)-1) {
        perror("fread failed");
        exit(99);
    }

    if (strstr(string4,string2) != NULL) /* If string2 is found */
        strpos = position ;             /* then save position. */

    if ((position=ftello(stream)) == -1LL)
        perror("Error saving file position.");

    rc = fread(string4, 1, sizeof(string2)-1, stream);
}

fclose(stream);
/* Replace line containing string2 with string3 */

fd = open("test.data",O_RDWR);

if (fd < 0){
    perror("open failed\n");
}

x = write(fd,"a record",8);

if (x < 8){
    perror("write failed\n");
}
strpos = lseek(fd,0LL,SEEK_SET); /* Note off_t is 64bits with _LARGE_FILES */
/* set and the off_t variable */
/* needs a 64bit constant of 0LL */

x = read(fd,buffer,8);

if (x < 8){
    perror("read failed\n");
}
printf("data read is %.8s\n",buffer);

close(fd);
}

```

*Example of HFS stream input and output functions (Part 2 of 2)*

---

## **fldata() behavior**

The format of the fldata() function is as follows:

```
int fldata(FILE *file, char *filename,
           fldata_t
           *info);
```

The `fldata()` function is used to retrieve information about an open stream. The name of the file is returned in `filename` and other information is returned in the `fldata_t` structure, shown in Figure 23. Values specific to this category of I/O are shown in the comment beside the structure element. Additional notes pertaining to this category of I/O follow the figure. For more information on the `fldata()` function, refer to *z/OS XL C/C++ Runtime Library Reference*.

```
struct __fileData {
    unsigned int  __recfmF   : 1, /* always off          */
                 __recfmV   : 1, /* always off          */
                 __recfmU   : 1, /* always on           */
                 __recfmS   : 1, /* always off          */
                 __recfmBlk  : 1, /* always off          */
                 __recfmASA  : 1, /* always off          */
                 __recfmM   : 1, /* always off          */
                 __dsorgPO   : 1, /* N/A -- always off  */
                 __dsorgPDSmem : 1, /* N/A -- always off  */
                 __dsorgPDSdir : 1, /* N/A -- always off  */
                 __dsorgPS   : 1, /* N/A -- always off  */
                 __dsorgConcat : 1, /* N/A -- always off  */
                 __dsorgMem   : 1, /* N/A -- always off  */
                 __dsorgHiper : 1, /* N/A -- always off  */
                 __dsorgTemp  : 1, /* N/A -- always off  */
                 __dsorgVSAM  : 1, /* N/A -- always off  */
                 __dsorgHFS   : 1, /* always on           */
                 __openmode  : 2, /* one of:             */
                                /* __BINARY             */
                                /* __RECORD             */
                 __modeflag  : 4, /* combination of:    */
                                /* __READ               */
                                /* __WRITE              */
                                /* __APPEND             */
                                /* __UPDATE             */
                 __dsorgPDSE : 1, /* N/A -- always off  */
                 __reserve2  : 8; /*                    */
    __device_t   __device;  /* __HFS               */
    unsigned long __blksize, /* 0                   */
                 __maxreclen; /*                    */
    unsigned short __vsamtype; /* N/A                 */
    unsigned long  __vsamkeylen; /* N/A                 */
    unsigned long  __vsamRKP; /* N/A                 */
    char *         __dsname; /*                    */
    unsigned int  __reserve4; /*                    */
};
typedef struct __fileData fldata_t;
```

Figure 23. `fldata()` structure

**Notes:**

1. The `filename` is the same as specified on the `fopen()` or `freopen()` function call.
2. The `__maxreclen` value is 0 for regular I/O (binary). For record I/O the value is `lrecl` or the default of 1024 when `lrecl` is not specified.
3. The `__dsname` value is the real POSIX pathname.

---

## File tagging and conversion

In general, the file system knows the contents of a file only as a set of bytes. Applications which create and process bytes in a file know whether these bytes represent binary data, text (character) data, or a mixture of both. File tags are file metadata fields which describe the contents of a file. Enhanced ASCII includes the following file tag fields:

**txtflag** A flag indicating if a file consists solely of character data encoded by a single coded character set ID (CCSID).

**file ccsid**

A 16 bit field specifying the CCSID of characters in the file.

Applications can explicitly tag files using new `open()` or `fcntl()` options, or applications can allow the logical file system (LFS) to tag new files on first write, `fopen()`. A new environment variable, `_BPXK_CCSID`, is used to assign a program CCSID to an application, which LFS will use to tag new files on first write. LFS also uses the program CCSID derived from `_BPXK_CCSID` to set up auto-conversion of pure text datastreams. LFS attempts to set up auto-conversion when:

- Auto-conversion is enabled for an application by the `_BPXK_AUTOCVT` environment variable
- The file `txtflag` flag is set indicating a pure text file
- The file and program CCSIDs do not match.

Automatic file conversion and file tagging include the following facilities:

- `_OPEN_SYS_FILE_EXT` feature test macro. For more information, see *z/OS XL C/C++ Runtime Library Reference*.
- `_BPXK_AUTOCVT` and `_BPXK_CCSIDS` environment variables. For more information, see Chapter 32, "Using environment variables," on page 467.
- `z/OS Language Environment FILETAG` runtime option. For more information, see *z/OS Language Environment Programming Reference*.
- `__chattr()` and `__fchattr()` functions; `F_SETTAG` and `F_CONTROL_CVT` arguments for the `fcntl()` function; options for the `fopen()`, `popen()`, `stat()`, `fstat()`, and `lstat()` functions. For more information, see *z/OS XL C/C++ Runtime Library Reference*.

---

## Access control lists (ACLs)

Access control lists (ACLs) enable you to control access to files and directories by individual user (UID) and group (GID). ACLs are used in conjunction with permission bits. You can create, modify, and delete ACLs using the following functions:

- `acl_create_entry()`
- `acl_delete_entry()`
- `acl_delete_fd()`
- `acl_delete_file()`
- `acl_first_entry()`
- `acl_free()`
- `acl_from_text()`
- `acl_get_entry()`
- `acl_get_fd()`
- `acl_get_file()`



- `acl_init()`
- `acl_set_fd()`
- `acl_set_file()`
- `acl_sort()`
- `acl_to_text()`
- `acl_update_entry()`
- `acl_valid()`

For descriptions of these functions see *z/OS XL C/C++ Runtime Library Reference*.  
For more information on using ACLs to protect file system resources see *z/OS UNIX System Services Planning* and *z/OS Security Server RACF Security Administrator's Guide*.

---

## Chapter 12. Performing VSAM I/O operations

This chapter outlines the use of Virtual Storage Access Method (VSAM) data sets in z/OS XL C/C++. Three I/O processing modes for VSAM data sets are available in z/OS XL C/C++:

- Record
- Text Stream
- Binary Stream

Because VSAM is a record-based access method, record mode is the logical processing mode and is specified by coding the `type=record` keyword parameter on the `fopen()` function call. z/OS XL C/C++ also provides limited support for VSAM text streams and binary streams. Because of the record-based nature of VSAM, this chapter is organized differently from the other chapters in this section. The focus of this chapter is on record I/O, and only those aspects of text and binary I/O that are specific to VSAM are also discussed.

For more information about the facilities of VSAM, see the list of “DFSMS” on page 1176 publications.

See Chapter 8, “z/OS XL C Support for the double-byte character set,” on page 53 for information about using wide-character I/O with z/OS XL C/C++.

### Notes:

1. This chapter describes C I/O as it can be used within C++ programs.
2. The C++ I/O stream libraries cannot be used for VSAM I/O because these do not support the record processing mode (where `type=record` is specified).
3. Starting in z/OS V1R10, the C/C++ runtime library provides support for VSAM data sets in the extended addressing space on extended address volumes (EAVs).

---

## VSAM types (data set organization)

There are three types of VSAM data sets supported by z/OS XL C/C++, all of which are held on direct-access storage devices.

- Key-Sequenced Data Set (KSDS) is used when a record is accessed through a key field within the record (for example, an employee directory file where the employee number can be used to access the record). KSDS also supports sequential access. Each record in a KSDS must have a unique key value.
- Entry-Sequenced Data Set (ESDS) is used for data that is primarily accessed in the order it was created (or the reverse order). It supports direct access by Relative Byte Address (RBA), and sequential access.
- Relative Record Data Set (RRDS) is used for data in which each item has a particular number, and the relevant record is accessed by that number (for example, a telephone system with a record associated with each number). It supports direct access by Relative Record Number (RRN), and sequential access.

In addition to the primary VSAM access described above, for KSDS and ESDS, there is also direct access by one or more additional key fields within each record. These additional keys can be unique or non-unique; they are called an alternate index (AIX).

**Notes:**

1. VSAM Linear Data Sets are not supported in z/OS XL C/C++ I/O.
2. z/OS XL C/C++ supports extended addressable KSDS, ESDS, and RRDS data sets. Extended addressable KSDS data sets can be accessed through an alternate index, but extended addressable ESDS data sets cannot.

## Access method services

Access Method Services are generally known by the name IDCAMS on MVS. For more information, see *z/OS DFSMS Access Method Services Commands*.

Before a VSAM data set is used for the first time, its structure is defined to the system by the Access Method Services DEFINE CLUSTER command. This command defines the type of VSAM data set, its structure, and the space it requires.

Before a VSAM alternate index is used for the first time, its structure is defined to the system by the Access Method Services DEFINE ALTERNATEINDEX command. To enable access to the base cluster records through the alternate index, use the DEFINE PATH command. Finally, to build the alternate index, use the BLDINDEX command.

When you have built the alternate index, you call `fopen()` and specify the PATH in order to access the base cluster through the alternate index. Do not use `fopen()` to access the alternate index itself.

**Note:** You cannot use the BLDINDEX command on an empty base cluster.

---

## Choosing VSAM data set types

When you plan your program, you must first decide the type of data set to use. Figure 24 on page 153 shows you the possibilities available with the types of VSAM data sets.

The diagrams show how the information contained in the family tree below could be held in VSAM data sets of different types.

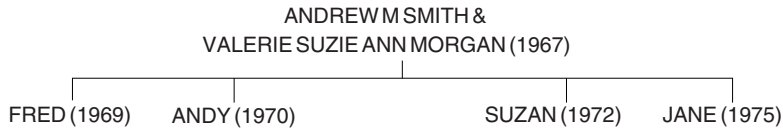

Key-Sequenced Data Set

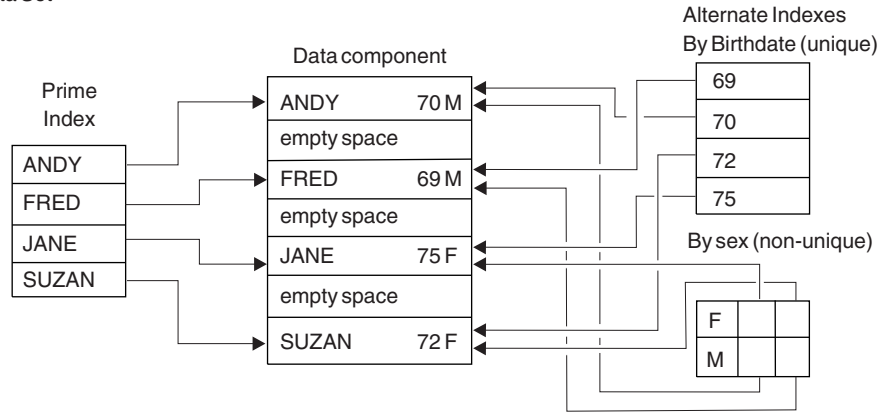

Entry-Sequenced Data Set

Relative byte addresses can be accessed and used as keys

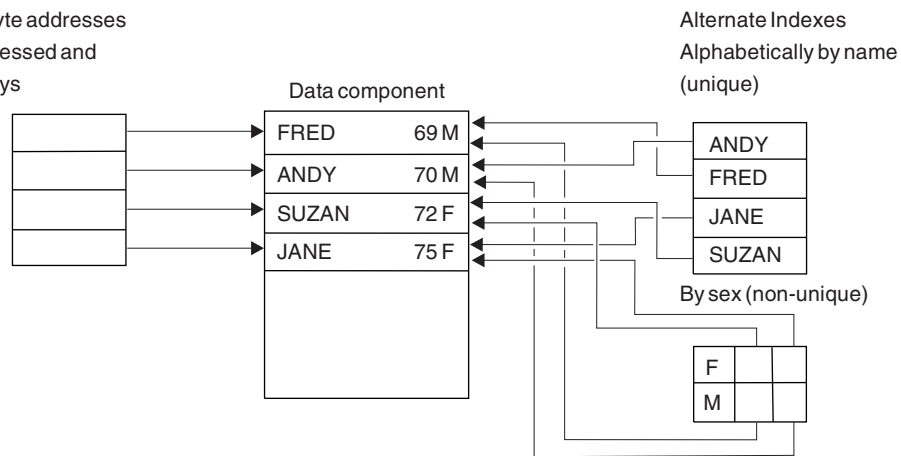

Relative Record Data Set

Relative record numbers can be accessed and used as keys

Slot	Data component
1	FRED 69 M
2	ANDY 70 M
3	empty space for 71
4	SUZAN 72 F
5	empty space for 73
6	empty space for 74
7	JANE 75 F
8	empty space for 76

Each slot corresponds to a year

No Alternate Indexes

Figure 24. Types and advantages of VSAM data sets

When choosing the VSAM data set type, you should base your choice on the most common sequence in which you require data. You should follow a procedure similar to the one suggested below to help ensure a combination of data sets and indexes that provide the function you require.

1. Determine the type of data and its primary access.
  - sequentially — favors ESDS
  - by key — favors KSDS
  - by number — favors RRDS
2. Determine whether you require access through an alternate index path. These are only supported on KSDS and ESDS. If you do, determine whether the alternate index is to have unique or nonunique keys. You should keep in mind that making an assumption that all future records will have unique keys may not be practical, and an attempt to insert a record with a nonunique key in an index that has been created for unique keys causes an error.
3. When you have determined the data sets and paths that you require, ensure that the operations you have in mind are supported.

## Keys, RBAs and RRNs

All VSAM data sets have keys associated with their records. For KSDS, KSDS AIX, and ESDS AIX, the key is a defined field within the logical record. For ESDS, the key is the *relative byte address* (RBA) of the record. For RRDS, the key is a *relative record number* (RRN).

### Keys for indexed VSAM data sets

For KSDS, KSDS AIX, and ESDS AIX, keys are part of the logical records recorded on the data set. For KSDS, the length and location of the keys are defined by the DEFINE CLUSTER command of Access Method Services. For KSDS AIX and ESDS AIX, the keys are defined by the DEFINE ALTERNATEINDEX command.

### Relative byte addresses

Relative byte addresses (RBAs) enable you to access ESDS files directly. The RBAs are either 4 or 8 byte fields, depending on the usage, and their values are computed by VSAM. The 4 byte RBA can only be used when accessing within the first 4GB of a VSAM data set. The 8 byte RBA can be used to access beyond 4GB in an extended addressable VSAM data set.

#### Notes:

1. KSDS can also use RBAs. However, because the RBA of a KSDS record can change if an insert, delete or update operation is performed elsewhere in the file, it is not recommended.
2. You can call `flocate()` with RBA values in an RRDS cluster, but `flocate()` with RBA values does not work across control intervals. Therefore, using RBAs with RRDS clusters is not recommended. The RRDS access method does not support RBAs. z/OS XL C/C++ supports the use of RBAs in an RRDS cluster by translating the RBA value to an RRN. It does this by dividing the RBA value by the LRECL.
3. Alternate indexes do not allow positioning by RBA.

The RBA value is stored in the C structure `__amrc`, which is defined in the C `<stdio.h>` header file. The `__amrc->__RBA` field is defined as an unsigned int, and therefore will contain only a 4-byte RBA value. The `__amrc->__XRBA` field is 8 bytes (unsigned long long in AMODE 31 applications, and unsigned long in AMODE 64 applications), and therefore can hold the RBA for all locations within an extended addressable VSAM data set.

You can access the field `__amrc->__RBA`, as shown in `<xref refid="gvs1">`. This example code (CCNGVS1) can be converted to use `__amrc->__XRBA` with just a few modifications. For more information about the `__amrc` structure, refer to

```

/* this example shows how to access the __amrc->_RBA field */
/* it assumes that an ESDS has already been defined, and has been */
/* assigned the ddname ESDSCLUS */

#include <stdio.h>
#include <stdlib.h>

main() {
    FILE *ESDSfile;
    unsigned int myRBA;
    char recbuff[100]="This is record one.";
    int w_retcd;
    int l_retcd;
    int r_retcd;

    printf("calling fopen(\"dd:esdsclus\", \"rb+,type=record\");\n");
    ESDSfile = fopen("dd:esdsclus", "rb+,type=record");
    printf("fopen() returned 0X%.8x\n",ESDSfile);
    if (ESDSfile==NULL) exit;

    w_retcd = fwrite(recbuff, 1, sizeof(recbuff), ESDSfile);
    printf("fwrite() returned %d\n",w_retcd);
    if (w_retcd != sizeof(recbuff)) exit;
    myRBA = __amrc->_RBA;

    l_retcd = flocate(ESDSfile, &myRBA, sizeof(myRBA), __RBA_EQ);
    printf("flocate() returned %d\n",l_retcd);
    if (l_retcd !=0) exit;

    r_retcd = fread(recbuff, 1, sizeof(recbuff), ESDSfile);
    printf("fread() returned %d\n",r_retcd);
    if (l_retcd !=0) exit;

    return(0);
}

```

Figure 25. VSAM example

### Relative record numbers

Records in an RRDS are identified by a relative record number that starts at 1 and is incremented by 1 for each succeeding record position. Only RRDS files support accessing a record by its relative record number.

## Summary of VSAM I/O operations

Table 25 summarizes VSAM data set characteristics and the allowable I/O operations on them.

Table 25. Summary of VSAM data set characteristics and allowable I/O operations

Characteristic or I/O Operation	KSDS	ESDS	RRDS
Record Length	Variable. Length can be changed by update.	Variable. Length cannot be changed by update.	Fixed.
Alternate index <b>Note:</b> z/OS XL C/C++ does not support extended addressable ESDS alternate indexes.	Allows access using unique or non-unique keys.	Allows access using unique or non-unique keys.	Not supported by VSAM.
Record Read (Sequential)	The order is determined by the VSAM key	By entry sequence. Reads proceed in key sequence for the key of reference.	By relative record number.

Table 25. Summary of VSAM data set characteristics and allowable I/O operations (continued)

Characteristic or I/O Operation	KSDS	ESDS	RRDS
Record Write (Direct)	Position determined by the value in the field designated as the key.	Record written at the end of the file.	By relative record number.
Positioning for Record Read	By key or by RBA value. Positioning by RBA value is not recommended because changes to the file change the RBA.	By RBA value. Alternate index allows use by key.	By relative record number.
Delete (Record)	If not already in correct position, reposition the file pointer; read the record using <code>fread()</code> ; delete the record using <code>fdelrec()</code> . <code>fread()</code> must immediately precede <code>fdelrec()</code> .	Not supported by VSAM.	If not already in correct position, position the file pointer; read the record using <code>fread()</code> ; delete the record using <code>fdelrec()</code> . <code>fread()</code> must immediately precede <code>fdelrec()</code> .
Update (Record)	If not already in correct position, reposition the file pointer; read the record using <code>fread()</code> ; update the record using <code>fupdate()</code> . <code>fread()</code> must immediately precede <code>fupdate()</code> .	If not already in correct position, reposition the file pointer; read the record using <code>fread()</code> ; update the record using <code>fupdate()</code> . <code>fread()</code> must immediately precede <code>fupdate()</code> .	If not already in correct position, reposition the file pointer; read the record using <code>fread()</code> ; update the record using <code>fupdate()</code> . <code>fread()</code> must immediately precede <code>fupdate()</code> .
Empty the file	Define the file as reusable using the DEFINE CLUSTER command, and then open the data set in write ("wb, type=record" or "wb+, type=record") mode. Not supported for alternate indexes.	Define the file as reusable using the DEFINE CLUSTER command, and then open the data set in write ("wb, type=record" or "wb+, type=record") mode. Not supported for alternate indexes.	Define the file as reusable using the DEFINE CLUSTER command, and then open the data set in write ("wb, type=record" or "wb+, type=record") mode.
Stream Read	Supported by z/OS XL C/C++.	Supported by z/OS XL C/C++.	Supported by z/OS XL C/C++.
Stream Write/Update	Not supported by z/OS XL C/C++.	Supported by z/OS XL C/C++.	Supported by z/OS XL C/C++.
Stream Repositioning	Supported by z/OS XL C/C++.	Supported by z/OS XL C/C++.	Supported by z/OS XL C/C++.

## Opening VSAM data sets

To open a VSAM data set, use the Standard C library functions `fopen()` and `freopen()` just as you would for opening non-VSAM data sets. The `fopen()` and `freopen()` functions are described in *z/OS XL C/C++ Runtime Library Reference*.

This section describes considerations for using `fopen()` and `freopen()` with VSAM files. Remember that a VSAM file must exist and be defined as a VSAM cluster before you call `fopen()`.

### Using `fopen()` or `freopen()`

This section covers using file names for MVS data sets, specifying `fopen()` and `freopen()` keywords, and buffering.

## File names for MVS data sets: Using a data set name

The following diagram shows the syntax for the *filename* argument on your `fopen()` or `freopen()` call:

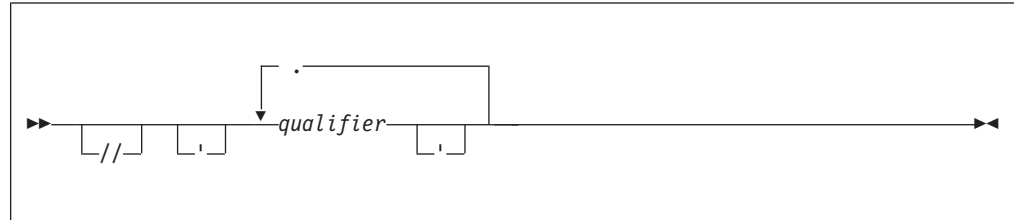

The following is a sample construct:

```
'qualifier1.qualifier2'
```

- Single quotation marks indicate that you are passing a *fully-qualified* data set name, that is, one which includes the high-level qualifier. If you pass a data set name without single quotation marks, the z/OS XL C/C++ compiler prefixes the high-level qualifier (usually the user ID) to the name. See Chapter 10, “Performing OS I/O operations,” on page 83 for information on fully qualified data set names.

// Specifying these slashes indicates that the file names refer to MVS data sets.

### *qualifier*

Each qualifier is a 1- to 8-character name. These characters may be alphanumeric, national (\$, #, @), the hyphen, or the character `\xC0`. The first character should be either alphabetic or national. Do not use hyphens in names for RACF-protected data sets.

You can join qualifiers with periods. The maximum length of a data set name is generally 44 characters, including periods.

To open a data set by its name, you can code something like the following in your C or C++ program:

```
infile=fopen("VSAM.CLUSTER1", "ab+, type=record");
```

## File names for MVS data sets: Using a DDname

To access a cluster or path by *ddname*, you can write the required DD statement and call `fopen()` as shown in the following example.

If your data set is `VSAM.CLUSTER1`, your C or C++ program refers to this data set by the *ddname* `CFILE`, and you want exclusive control of the data set for update, you can write the DD statement:

```
//CFILE DD DSNAME=VSAM.CLUSTER1,DISP=OLD
```

and code the following in your C or C++ source program:

```
#include <stdio.h>

FILE *infile;
main()
{
    infile=fopen("DD:CFILE", "ab+, type=record");
    :
}
```



To share your data set, use DISP=SHR on the DD statement. DISP=SHR is the default for fopen() calls that use a data set name and specify any of the r, rb, rb+, and r+b open modes.

**Note:** z/OS XL C/C++ does not check the value of shareoptions at fopen() time, and does not provide support for read-integrity and write-integrity, as required to share files under shareoptions 3 and 4.

For more information on shareoptions, see the information on DEFINE CLUSTER in the books listed in "DFSMS" on page 1176.

### Specifying fopen() and freopen() keywords

The *mode* argument is a character string specifying the type of access requested for the file. The *mode* argument contains one positional parameter (access mode) followed by keyword parameters. A description of these parameters, along with an explanation of how they apply to VSAM data sets is given the following sections.

**Specifying access mode:** The access mode is specified by the positional parameter of the fopen() function call. The possible record I/O and binary modes you can specify are:

- rb** Open for reading. If the file is empty, fopen() fails.
- wb** Open for writing. If the cluster is defined as reusable, the existing contents of the cluster are destroyed. If the cluster is defined as not reusable (clusters with paths are, by definition, not reusable), fopen() fails. However, if the cluster has been defined but not loaded, this mode can be used to do the initial load of both reusable and non reusable clusters.

**Note:** If a "key out of sequence" condition is encountered, the data set will automatically be reopened with a mode string "ab+" and will no longer be in create mode.

- ab** Open for writing.
- rb+ or r+b**  
Open for reading, writing, and/or updating.
- wb+ or w+b**  
Open for reading, writing, and/or updating. If the cluster is defined as reusable, the existing contents of the cluster are destroyed. If the cluster is defined as not reusable (clusters with paths are, by definition, not reusable), the fopen() fails. However, if the cluster has been defined but not loaded, this mode can be used to do the initial load of both reusable and non reusable clusters.
- ab+ or a+b**  
Open for reading, writing, and/or updating.

For text files, you can specify the following modes: r, w, a, r+, w+, and a+.

**Note:** For KSDS, KSDS AIX and ESDS AIX in text and binary I/O, the only valid modes are r and rb, respectively.

### fopen() and freopen() keywords

The following table lists the keywords that are available on the fopen() and freopen() functions, tells you which ones are useful for VSAM I/O, and lists the values that are valid for the applicable ones.

Table 26. Keywords for the `fopen()` and `freopen()` functions for VSAM data sets

Keyword	Allowed?	Applicable?	Notes
<code>recfm=</code>	Yes	No	Ignored.
<code>lrecl=</code>	Yes	No	Ignored.
<code>blksize=</code>	Yes	No	Ignored.
<code>space=</code>	Yes	No	Ignored.
<code>type=</code>	Yes	Yes	May be omitted. If you do specify it, <code>type=record</code> is the only valid value.
<code>acc=</code>	Yes	Yes	Specifies the access direction for VSAM data sets. Valid values are BWD and FWD.
<code>password=</code>	Yes	Yes	Specifies the password for a VSAM data set.
<code>asis</code>	Yes	No	Enables the use of mixed-case file names. Not supported for VSAM.
<code>byteseek</code>	Yes	Yes	Used for binary stream files to specify that the seeking functions should use relative byte offsets instead of encoded offsets. This is the default setting.
<code>noseek</code>	Yes	No	Ignored.
<code>OS</code>	Yes	No	Ignored.
<code>rls=</code>	Yes	Yes	Indicates the VSAM RLS/TVS access mode in which a VSAM file is to be opened.

## Keyword descriptions

### `recfm=`

Any values passed into `fopen()` are ignored.

### `lrecl=` and `blksize=`

These keywords are set to the maximum record size of the cluster as initialized in the cluster definition. Any values passed into `fopen()` are ignored.

### `space=`

This keyword is not supported under VSAM.

### `type=`

If you use the `type=` keyword, the only valid value for VSAM data sets is `type=record`. This opens a file for record I/O.

### `acc=`

For VSAM files opened with the keyword `type=record`, you can specify the direction by using the `acc=access_type` keyword on the `fopen()` function call. For text and binary files, the access direction is always forward. Attempts to open a VSAM data set with `acc=BWD` for either binary or text stream I/O will fail. The `access_type` can be one of the following:

**FWD** The `acc=FWD` keyword specifies that the file be processed in a forward direction. When the file is opened, it will be positioned at the beginning of the first physical record, and any subsequent read operations sets the file position indicator to the beginning of the next record. The default value for the access keyword is `acc=FWD`.

**BWD** The `acc=BWD` keyword specifies that the file be processed in a backward direction. When the file is opened, it is positioned at the beginning of the last physical record and any subsequent read operation sets the file position indicator to the beginning of the preceding record.

You can change the direction of sequential processing (from forward to backward or from backward to forward) by using the `flocate()` library function. For more information about `flocate()`, see “Repositioning within record I/O files” on page 165.

**Note:** When opening paths, records with duplicate alternate index keys are processed in order of arrival time (oldest to newest) regardless of the current processing direction.

**password=**

VSAM facilities provide password protection for your data sets. You access a data set that has password protection by specifying the password on the password keyword parameter of the `fopen()` function call; the password resides in the VSAM catalog entry for the named file. There can be more than one password in the VSAM catalog entry; data sets can have different passwords for different levels of authorization such as reading, writing, updating, inserting, or deleting. For a complete description of password protection on VSAM files, see the list of publications on “DFSMS” on page 1176.

The password keyword has the following form, where *x* is a 1- to 8-character password, and *n* is the exact number of characters in the password. The password can contain special characters such as blanks and commas.

password=*nx*

If a required password is not supplied, or if an incorrect password is given, `fopen()` fails.

**asis**

This keyword is not supported for VSAM.

**byteseek**

When you specify this keyword and open a file in binary stream mode, `fseek()` and `ftell()` use relative byte offsets from the beginning of the file. This is the default setting.

**noseek**

This keyword is ignored for VSAM data sets.

**OS**

This keyword is ignored for VSAM data sets.

**rls=**

Indicates the VSAM RLS/TVS access mode in which a VSAM file is to be opened. This keyword is ignored for non-VSAM files. The following values are valid:

- `nri` — No Read Integrity
- `cr` — Consistent Read
- `cre` — Consistent Read Explicit

**Note:** When the RLS keyword is specified, `DISP` is changed to default to `SHR` when dynamic allocation of the data set is performed. In the rare case when a batch job must use RLS without sharing the data set with other tasks, `DISP` should be `OLD`. To set `DISP` to `OLD`, the application must specify `DISP=OLD` in the DD statement and start the application using JCL. You cannot specify `DISP` in the `fopen()` mode argument.

## Buffering

Full buffering is the default. You can specify line buffering, but z/OS XL C/C++ treats line buffering as full buffering for VSAM data sets. Unbuffered I/O is not supported under VSAM; if you specify it, your `setvbuf()` call fails.

To find out how to optimize VSAM performance by controlling the number of VSAM buffers used for your data set, refer to *z/OS DFSMS Access Method Services Commands*.

---

## Record I/O in VSAM

This section describes how to use record I/O in VSAM. The following topics are covered:

- RRDS Record Structure
- RRDS Record Structure
- Reading Record I/O Files
- Writing to Record I/O Files
- Updating Record I/O Files
- Deleting Records
- Repositioning within Record I/O Files
- Flushing Buffers
- Summary of VSAM Record I/O Operations
- Reading from Text and Binary I/O Files
- Writing to and Updating Text and Binary I/O Files
- Deleting Records in Text and Binary I/O Files
- Repositioning within Text and Binary I/O Files
- Flushing Buffers
- Summary of VSAM Text I/O Operations
- Summary of VSAM Binary I/O Operations

## RRDS record structure

For RRDS files opened in record mode, z/OS XL C/C++ defines the following key structure in the C header file `<stdio.h>`:

```
typedef struct {
#ifdef _LP64
    unsigned int __fill, /* version: either 0 or 1 */
                __recnum; /* the key, starting at 1 */
#else
    unsigned long __fill, /* version: either 0 or 1 */
                 __recnum; /* the key, starting at 1 */
#endif /* not _LP64 */
} __rrds_key_type;
```

In your source program, you can define an RRDS record structure as either:

```
struct {
    __rrds_key_type rrds_key; /* __fill value always 0 */
    char data[MY_REC_SIZE];
} rrds_rec_0;
```

or:

```
struct {
    __rrds_key_type rrds_key;    /* __fill value always 1 */
    char            *data;
} rrds_rec_1;
```

The z/OS XL C/C++ library recognizes which type of record structures you have used by the value of `rrds_key.__fill`. Zero indicates that the data is contiguous with `rrds_key` and 1 indicates that a pointer to the data follows `rrds_key`.

## Reading record I/O files

To read from a VSAM data set opened with `type=record`, use the Standard C `fread()` library function. If you set the `size` argument to 1 and the `count` argument to the maximum record size, `fread()` returns the number of bytes read successfully. For more information on `fread()`, see *z/OS XL C/C++ Runtime Library Reference*.

`fread()` reads one record from the system from the current file position. Thus, if you want to read a certain record, you can call `flocate()` to position the file pointer to point to it; the subsequent call to `fread()` reads in that record.

If you use an `fread()` call to request more bytes than the record about to be read contains, `fread()` reads the entire record and returns the number of bytes read. If you use `fread()` to request fewer bytes than the record about to read contains, `fread()` reads the number of bytes that you specified and returns your request.

z/OS XL C/C++ VSAM Record I/O does not allow a read operation to immediately follow a write operation without an intervening reposition. z/OS XL C/C++ treats the following as read operations:

- Calls to read functions that request 0 bytes
- Read requests that fail because of a system error
- Calls to the `ungetc()` function

Calling `fread()` several times in succession, with no other operations on this file in between, reads several records in sequence (sequential processing), which can be forward or backward, depending on the access direction, as described in the following.

- **KSDS, KSDS AIX and ESDS AIX**

The records are retrieved according to the sequence of the key of reference, or in reverse key sequence.

**Note:** Records with duplicate alternate index keys are processed in order of arrival time (oldest to newest) regardless of the current processing direction

- **ESDS**

The records are retrieved according to the sequence they were written to the file (entry sequence), or in reverse entry sequence.

- **RRDS**

The records are retrieved according to relative record number sequence or reverse relative record number sequence.

When records are being read, RRNs without an associated record are ignored. For example, if a file has relative records of 1, 2, and 5, the nonexistent records 3 and 4 are ignored.

By default, in record mode, `fread()` must be called with a pointer to an RRDS record structure. The field `__rrds_key_type.__fill` must be set to either 0 or 1 indicating the type of the structure, and the count argument must include the length of the `__rrds_key_type`. `fread()` returns the RRN number in the `__recnum` field, and includes the length of the `__rrds_key_type` in the return value. You can override these operations by setting the `_EDC_RRDS_HIDE_KEY` environment variable to Y. Once this variable is set, `fread()` is called with a data buffer and not an RRDS data structure. The return value of `fread()` is now only the length of the data read. In this case, `fread()` cannot return the RRN. For information on setting environment variables, see Chapter 32, "Using environment variables," on page 467.

## Writing to record I/O files

To write new records to a VSAM data set opened with `type=record`, use the Standard C `fwrite()` library function. If you set `size` to 1 and `count` to the desired record size, `fwrite()` returns the number of bytes written successfully. For more information on `fwrite()` and the `type=record` parameter, see *z/OS XL C/C++ Runtime Library Reference*.

In general, C I/O does not allow a write operation to follow a read operation without an intervening reposition or `fflush()`. `z/OS XL C/C++` counts a call to a write function writing 0 bytes or a write request that fails because of a system error as a write operation. However, `z/OS XL C/C++` VSAM record I/O allows a write to directly follow a read. This feature has been provided for compatibility with earlier releases.

The process of writing to a data set for the first time is known as *initial loading*. Using the `fwrite()` function, you can write to a new VSAM file in *initial load* mode just as you would to a file not in *initial load* mode. Writing to a KSDS PATH or an ESDS PATH in *initial load* mode is not supported.

If your `fwrite()` call does not try to write more bytes than the maximum record size, `fwrite()` writes a record of the length you asked for and returns your request. If your `fwrite()` call asks for more than the maximum record size, `fwrite()` writes the maximum record size, sets `errno`, and returns the maximum record size. In either case, the next call to `fwrite()` writes to the following record.

**Note:** If an `fwrite()` fails, you must reposition the file before you try to read or write again.

- **KSDS, KSDS AIX**

Records are written to the cluster according to the value stored in the field designated as the prime key.

You can load a KSDS in any key order but it is most efficient to perform the `fwrite()` operations in key sequence.

- **ESDS, ESDS AIX**

Records are written to the end of the file.

- **RRDS**

Records are written according to the value stored in the relative record number field.

`fwrite()` is called with the RRDS record structure.

By default, in record mode, `fwrite()` and `fupdate()` must be called with a pointer to an RRDS record structure. The `__rrds_key_type` fields `__fill` and `__recnum` must be set. `__fill` is set to 0 or 1 to indicate the type of the structure.

The `__recnum` field specifies the RRN to write, and is required for `fwrite()` but not `fupdate()`. The count argument must include the length of the `__rrds_key_type`. `fwrite()` and `fupdate()` include the length of the `__rrds_key_type` in the return value.

## Updating record I/O files

The `fupdate()` function, a z/OS XL C/C++ extension to the SAA C library, is used to update records in a VSAM file. For more information on this function, see *z/OS XL C/C++ Runtime Library Reference*.

- **KSDS, ESDS, and RRDS**

To update a record in a VSAM file, you must perform the following operations:

1. Open the VSAM file in update mode (`rb+/r+b`, `wb+/w+b`, or `ab+/a+b` specified as the required positional parameter of the `fopen()` function call and `type=record`).
2. If the file is not already positioned at the record you want to update, reposition to that record.
3. Read in the record using `fread()`.

Once the record you want to update has been read in, you must ensure that no reading, writing, or repositioning operations are performed before `fupdate()`.

4. Make the necessary changes to the copy of the record in your buffer area.
5. Update the record from your local buffer area using the `fupdate()` function. If an `fupdate()` fails, you must reposition using `flocate()` before trying to read or write.

**Notes:**

1. If a file is opened in update mode, a read operation can result in the locking of control intervals, depending on `shareoptions` specification of the VSAM file. If after reading a record, you decide not to update it, you may need to unlock a control interval by performing a file positioning operation to the same record, such as an `flocate()` using the same key.
2. If `fupdate()` wrote out a record the file position is the start of the next record. If the `fupdate()` call did not write out a record, the file position remains the same.

- **KSDS and KSDS PATH**

You can change the length of the record being updated. If your request does not exceed the maximum record size of the file, `fupdate()` writes a record of the length requested and returns the request. If your request exceeds the maximum record size of the file, `fupdate()` writes a record that is the maximum record size, sets `errno`, and returns the maximum record size.

You cannot change the prime key field of the record, and in KSDS AIX, you cannot change the key of reference of the record.

- **ESDS**

You cannot change the length of the record being updated. If the size of the record being updated is less than the current record size, `fupdate()` updates the amount you specify and does not alter the data remaining in the record. If your request exceeds the length of the record that was read, `fupdate()` writes a record that is the length of the record that was read, sets `errno`, and returns the length of the record that was read.

- **ESDS PATH**



You cannot change the length of the record being updated or the key of reference of the record. If the size of the record being updated is less than the current record size, `fupdate()` updates the amount you specify and does not alter the data remaining in the record. If your request exceeds the length of the record that was read, `fupdate()` writes a record that is the length of the record that was read, sets `errno`, and returns the length of the record that was read.

- **RRDS**

RRDS files have fixed record length. If you update the record with less than the record size, only those characters specified are updated, and the remaining data is not altered. If your request exceeds the record size of the file, `fupdate()` writes a record that is the record size, sets `errno`, and returns the length of the record that was read.

## Deleting records

To delete records, use the library function `fdelrec()`, a z/OS XL C/C++ extension to the SAA C library. For more information on this function, see *z/OS XL C/C++ Runtime Library Reference*.

- **KSDS, KSDS PATH, and RRDS**

To delete records, you must perform the following operations:

1. Open the VSAM file in update mode (`rb+/r+b`, `ab+/a+b`, or `wb+/w+b` specified as the required positional parameter of the `fopen()` function call and `type=record`).

2. If the file is not already positioned at the record you want to delete, reposition to that record.

3. Read the record using the `fread()` function.

Once the record you want to delete has been read in, you must ensure that no reading, writing, or repositioning operations are performed before `fdelrec()`.

4. Delete the record using the `fdelrec()` function.

**Note:** If the data set was opened with an access mode of `rb+` or `r+b`, a read operation can result in the locking of control intervals, depending on `shareoptions` specification of the VSAM file. If after reading a record, you decide not to delete it, you may need to unlock a control interval by performing a file-positioning operation to the same record, such as an `flocate()` using the same key.

- **ESDS and ESDS PATH**

VSAM does not support deletion of records in ESDS files.

## Repositioning within record I/O files

You can use the following functions to locate a record within a VSAM data set:

- `flocate()`
- `ftell()`, `ftello()` and `fseek()`, `fseeko()`
- `fgetpos()` and `fsetpos()`
- `rewind()`

For complete details on these library functions, see *z/OS XL C/C++ Runtime Library Reference*.



## **flocate()**

The `flocate()` C library function can be used to locate a specific record within a VSAM data set given the key, relative byte address, or the relative record number. The `flocate()` function also sets the access direction.

VSAM extended addressability support includes an 8 byte RBA for use with positioning functions such as `flocate()`. `flocate()` supports RBA lengths of 4 and 8 bytes. Existing applications that use `flocate()` with a 4 byte RBA will continue unaffected, but must use a key length of 8 to locate an RBA beyond 4GB.

The following `flocate()` parameters set the access direction to forward:

- `__KEY_FIRST` (the `key` and `key_len` parameters are ignored)
- `__KEY_EQ`
- `__KEY_GE`
- `__RBA_EQ`

The following `flocate()` parameters all set the access direction to backward and are only valid for record I/O:

- `__KEY_LAST` (the `key` and `key_len` parameters are ignored)
- `__KEY_EQ_BWD`
- `__RBA_EQ_BWD`

**Note:** The `__RBA_EQ` and `__RBA_EQ_BWD` parameters are not valid for paths and are not recommended for KSDS and RRDS data sets.

You can use the `rewind()` library function instead of calling `flocate()` with `__KEY_FIRST`.

- **KSDS, KSDS AIX, and ESDS AIX**

The `key` parameter of `flocate()` for the options `__KEY_EQ`, `__KEY_GE`, and `__KEY_EQ_BWD` is a pointer to the key of reference of the data set. The `key_len` parameter is the key length as defined for the data set for a full key search, or less than the defined key length for a generic key search (a partial key match). For KSDSs, `__RBA_EQ` and `__RBA_EQ_BWD` are supported, but are not recommended.

For `__KEY_EQ_BWD` the `key_len` parameter must be equal to the key length as defined for the data set for a full key search.

Alternate indexes do not allow positioning by RBA.

- **ESDS**

The `key` parameter of `flocate()` is a pointer to the specified RBA value. The `key_len` parameter is either 4 or 8 depending on the size of the RBA.

- **RRDS**

For `__KEY_EQ`, `__KEY_GE`, and `__KEY_EQ_BWD`, the `key` parameter of `flocate()` is a pointer to an unsigned long integer containing the specified relative record number. The `key_len` parameter is `sizeof(unsigned long)`. For `__RBA_EQ` and `__RBA_EQ_BWD`, the `key` parameter of `flocate()` is a pointer to the specified RBA. However, seeking to RBA values is not recommended, because it is not supported across control intervals. The `key_len` parameter is either 4 or 8 depending on the size of the RBA.

## **fgetpos() and fsetpos()**

`fgetpos()` is used to store the current file position and access direction. `fsetpos()` is used to relocate to a file position stored by `fgetpos()` and restore the saved access direction.

- **KSDS**

`fgetpos()` stores the RBA value. This RBA value may be invalidated by subsequent insertions, deletions, or updates.

- **KSDS AIX and ESDS AIX**

`fgetpos()` and `fsetpos()` are not supported for PATHs.

- **ESDS and RRDS**

There are no special considerations.

## **ftell() and fseek()**

`ftell()` is used to store the current file position. `fseek()` is used to relocate to one of the following:

- A file position stored by `ftell()`
- A calculated record number (`SEEK_SET`)
- A position relative to the current position (`SEEK_CUR`)
- A position relative to the end of the file (`SEEK_END`).

`ftell()` and `fseek()` offsets in record mode I/O are relative record offsets. For example, the following call moves the file position to the start of the previous record:

```
fseek(fp, -1L, SEEK_CUR);
```

You cannot use `fseek()` to reposition to a file position before the beginning of the file or to a position beyond the end of the file.

**Note:** In general, the performance of this method is inferior to `flocate()`.

The access direction is unchanged by the repositioning.

- **KSDS and RRDS**

There are no special considerations.

- **KSDS AIX and ESDS AIX**

`ftell()` and `fseek()` are not supported.

- **ESDS**

`ftell()` is not supported.

- **RRDS**

`fseek()` seeks to a relative position in the file, and not to an RRN value. For example, in a file consisting of RRNs 1, 3, 5 and 7, `fseek(fp, 3L, SEEK_SET);` followed by an `fread()` would read in RRN 7, which is at offset 3 in the file.

## **rewind()**

The `rewind()` function repositions the file position to the beginning of the file, and clears the error setting for the file. `rewind()` does not reset the file access direction. For example, a call to `flocate()` with `__KEY_LAST` sets the file pointer to the end of the file and sets the access direction to backwards. A subsequent call to `rewind()` sets the file pointer to the beginning of the file, but the access direction remains backwards.

## Flushing buffers

You can use the C library function `fflush()` to flush buffers. However, `fflush()` writes nothing to the system, because all records have already been written there by `fwrite()`. `fflush()` after a read operation does not refresh the contents of the buffer. For more information on `fflush()`, see *z/OS XL C/C++ Runtime Library Reference*.

## Summary of VSAM record I/O operations

Table 27. Summary of VSAM record I/O operations

	KSDS	ESDS	RRDS	PATH
<code>fopen()</code> , <code>freopen()</code>	rb, rb+, ab, ab+, wb, wb+ (empty cluster or reuse specified for wb & wb+)	rb, rb+, ab, ab+, wb, wb+ (empty cluster or reuse specified for wb & wb+)	rb, rb+, ab, ab+, wb, wb+ (empty cluster or reuse specified for wb & wb+)	rb, rb+, ab, ab+
<code>fwrite()</code> , <code>fwrite_unlocked()</code>	rb+, ab, ab+, wb, wb+	rb+, ab, ab+, wb, wb+	rb+, ab, ab+, wb, wb+	rb+, ab, ab+
<code>fread()</code> , <code>fread_unlocked()</code>	rb, rb+, ab+, wb+	rb, rb+, ab+, wb+	rb, rb+, ab+, wb+	rb, rb+, ab+
<code>ftell()</code> , <code>ftell_unlocked()</code>	rb, rb+, ab, ab+, wb, wb+ (see note 1)		rb, rb+, ab, ab+, wb, wb+	
<code>ftello()</code> , <code>ftello_unlocked()</code>	rb, rb+, ab, ab+, wb, wb+ (see note 1)		rb, rb+, ab, ab+, wb, wb+	
<code>fseek()</code> , <code>fseek_unlocked()</code>	rb, rb+, ab, ab+, wb, wb+ (see note 1)	rb, rb+, ab, ab+, wb, wb+	rb, rb+, ab, ab+, wb, wb+	
<code>fseeko()</code> , <code>fseeko_unlocked()</code>	rb, rb+, ab, ab+, wb, wb+ (see note 1)	rb, rb+, ab, ab+, wb, wb+	rb, rb+, ab, ab+, wb, wb+	
<code>fgetpos()</code> , <code>fgetpos_unlocked()</code>	rb, rb+, ab, ab+, wb, wb+ (see note 2)	rb, rb+, ab, ab+, wb, wb+	rb, rb+, ab, ab+, wb, wb+	
<code>fsetpos()</code> , <code>fsetpos_unlocked()</code>	rb, rb+, ab, ab+, wb, wb+ (see note 2)	rb, rb+, ab, ab+, wb, wb+	rb, rb+, ab, ab+, wb, wb+	
<code>flocate()</code> , <code>flocate_unlocked()</code>	rb, rb+, ab+, wb+	rb, rb+, ab+, wb+	rb, rb+, ab+, wb+	rb, rb+, ab+
<code>rewind()</code> , <code>rewind_unlocked()</code>	rb, rb+, ab, ab+, wb, wb+	rb, rb+, ab, ab+, wb, wb+	rb, rb+, ab, ab+, wb, wb+	rb, rb+, ab, ab+
<code>fflush()</code> , <code>fflush_unlocked()</code>	rb, rb+, ab, ab+, wb, wb+	rb, rb+, ab, ab+, wb, wb+	rb, rb+, ab, ab+, wb, wb+	rb, rb+, ab, ab+
<code>fdelrec()</code> , <code>fdelrec_unlocked()</code>	rb+, ab+, wb+		rb+, ab+, wb+	rb+, ab+ (not ESDS)
<code>fupdate()</code> , <code>fupdate_unlocked()</code>	rb+, ab+, wb+	rb+, ab+, wb+	rb+, ab+, wb+	rb+, ab+
<code>ferror()</code> , <code>ferror_unlocked()</code>	rb, rb+, ab, ab+, wb, wb+	rb, rb+, ab, ab+, wb, wb+	rb, rb+, ab, ab+, wb, wb+	rb, rb+, ab, ab+
<code>feof()</code> , <code>feof_unlocked()</code>	rb, rb+, ab, ab+, wb, wb+	rb, rb+, ab, ab+, wb, wb+	rb, rb+, ab, ab+, wb, wb+	rb, rb+, ab, ab+
<code>clearerr()</code> , <code>clearerr_unlocked()</code>	rb, rb+, ab, ab+, wb, wb+	rb, rb+, ab, ab+, wb, wb+	rb, rb+, ab, ab+, wb, wb+	rb, rb+, ab, ab+
<code>fclose()</code>	rb, rb+, ab, ab+, wb, wb+	rb, rb+, ab, ab+, wb, wb+	rb, rb+, ab, ab+, wb, wb+	rb, rb+, ab, ab+
<code>fldata()</code> , <code>fldata_unlocked()</code>	rb, rb+, ab, ab+, wb, wb+	rb, rb+, ab, ab+, wb, wb+	rb, rb+, ab, ab+, wb, wb+	rb, rb+, ab, ab+

Table 27. Summary of VSAM record I/O operations (continued)

	KSDS	ESDS	RRDS	PATH
<b>Notes:</b>				
1.	The saved position is based on the relative position of the record within the data set. Subsequent insertions or deletions may invalidate the saved position.			
2.	The saved position is based on the RBA of the record. Subsequent insertions, deletions or updates may invalidate the saved position.			

## VSAM record level sharing and transactional VSAM

VSAM Record Level Sharing (RLS) and Transactional VSAM (VSAM RLS/TVS) provide for the sharing of VSAM data at the record level, using the locking and caching functions of the coupling facility hardware. For more information on Record Level Sharing, see *z/OS DFSMS Introduction*.

The C/C++ runtime library provides the following support for VSAM RLS/TVS:

- Specification of RLS/TVS-related keywords in the mode string of `fopen()` and `freopen()`.
- Specification of RLS/TVS-related text unit key values in the `__dyn_t` structure, which is used as input to the `dynalloc()` function.
- Provides the application with VSAM return and reason codes for VSAM I/O errors.
- Performs implicit positioning for files opened for RLS/TVS access.

VSAM RLS/TVS has three read integrity file access modes. These modes tell VSAM the level of locking to perform when records are accessed within a file that has **not been opened in update mode**. The access modes are:

- nri** No Read Integrity indicates that requests performed by the application are not to be serialized with updates or erases of the records by other calling programs. VSAM accesses the records without obtaining a lock on the record.
- cr** Consistent Read indicates that requests performed by the application are to be serialized with updates or erases of the records by other calling programs. VSAM obtains a share lock when accessing the record. This lock is released once the record has been returned to the caller.
- cre** Consistent Read Explicit indicates that requests performed by the application are to be serialized with updates or erases of the records by other requestors. VSAM obtains a share lock when accessing the record. This lock is held until the application commits its changes. This ensures that records read by the application are not changed by other requestors until the application commits or aborts its changes. Consistent Read Explicit is for use only by commit protocol applications.

VSAM RLS locks records to support record integrity. An application may wait for an exclusive record lock if another user has the record locked. The application is also subject to new locking errors such as deadlock or timeout errors.

If the file has been **opened in update mode**, and `RLS=CR` or `RLS=CRE` is specified, VSAM also serializes access to the records within the file. However, the type of serialization differs from **non-update mode** in the following ways:

- A reposition within the file causes VSAM to obtain a share lock for the record.

- A read of a record causes VSAM to obtain an exclusive lock for the record. The lock is held until the record is updated in the file, or another record is read. If RLS=CRE is specified (for commit protocol applications), the lock is held until the application commits or aborts its changes.

**Notes:**

1. When a file is opened, it is implicitly positioned to the first record to be accessed.
2. You can also specify the RLS/TVS keyword on the JCL DD statement. When specified on both the JCL DD statement and in the mode string on fopen() or freopen(), the read integrity options specified in the mode string override those specified on the JCL DD statement.
3. VSAM RLS/TVS access is supported for the 3 types of VSAM files that the C/C++ runtime library supports: Key-Sequenced (KSDS), Entry-Sequenced (ESDS), and Relative Record (RRDS) data sets.
4. VSAM RLS/TVS functions require the use of a Coupling Facility. For more information on using the Coupling Facility, see *z/OS DFSMS Introduction*, and *z/OS Parallel Sysplex Overview*.
5. In an environment where one thread opens and another thread issues record management requests, VSAM RLS/TVS requires that record management requests be issued from a thread whose Task Control Block (TCB) is subordinate to the TCB of the thread which opened the file.
6. VSAM RLS/TVS does not support the following:
  - Key range data sets
  - Direct open of an AIX cluster as a KSDS
  - Access to individual components of a cluster
  - OS Checkpoint and Restart

## Error reporting

Errors are reported through the `__amrc` structure and the SIGIOERR signal. The following are additional considerations for error reporting in a VSAM RLS application:

- VSAM RLS/TVS uses the SMSVSAM server address space. When a file open fails because the server is not available, the C runtime library places the error return code and error value in the `__amrc` structure, and returns a null file descriptor. Record management requests return specific error return/reason codes, if the SMSVSAM server is not available. The server address space is automatically restarted. To recover from this type of error, an application should first close the file to clean up the file status, and then open the file prior to attempting record management requests. The close for the file returns a return code of 4, and an error code of 170(X'AA'). This is the expected result. It is not an error.
- Opening a recoverable file for output is not supported. If you attempt to do so, the open will fail with error return code 255 in the `__amrc` structure.
- Some of the VSAM errors, that are reported in the `__amrc` structure, are situations from which an application can recover. These are problems that can occur unpredictably in a sharing environment. Usually, the application can recover by simply accessing another record. Examples of such errors are the following:
  - RC 8, 21(X'15'): Request cancelled as part of deadlock resolution.
  - RC 8, 22(X'16'): Request cancelled as part of timeout resolution.

- RC 8, 24(X'18'): Request cancelled because transaction backout is pending on the requested record.
- RC 8, 29(X'14'): Intra-luwid contention between threads under a given TCB.

The application can intercept errors by registering a condition handler for the SIGIOERR condition. Within the condition handler, the application can examine the information in the `__amrc` structure and determine how to recover from each specific situation.

Refer to *z/OS DFSMS Macro Instructions for Data Sets* for a complete list of return and reason codes.

## VSAM extended addressability

DFSMS supports VSAM data sets greater than 4GB in size through extended addressability (XADDR) support. XADDR support is an extension to DFSMS extended-format data set support. VSAM XADDR supports key sequenced data sets (KSDS), entry sequenced data sets (ESDS), and relative-record data set (RRDS).

**Restriction:** z/OS XL C/C++ does not support XADDR for ESDS alternate indexes.

VSAM XADDR support includes an 8 byte relative byte address for use with positioning functions such as `flocate()`. `flocate()` supports key lengths of 4 and 8 bytes. Existing applications that use `flocate()` to locate with a 4 byte relative byte address will continue unaffected, but must use a key length of 8 to locate a record within XADDR addresses.

The RBA field in the `__amrc` structure is set to -1 when applications access beyond the addresses that can be represented by the 4 byte value, effectively appearing to be EOF to any 4 byte RBA positioning (`flocate()`) calls. The `__XRBA` field will always be updated with the address, and must be used in these cases.

For AMODE 31 applications repositioning within a VSAM data set, users of `ftell()` and `fseek()` that need to access XADDR addresses, must use the large file version of `ftello()` and `fseeko()`.

XADDR support for AMODE 31 applications is listed in the following table:

*Table 28. AMODE31 application XADDR support*

Function	XADDR support
<code>fgetpos()</code> , <code>fgetpos_unlocked()</code>	Yes
<code>fsetpos()</code> , <code>fsetpos_unlocked()</code>	Yes
<code>ftell()</code> , <code>ftell_unlocked()</code>	No
<code>fseek()</code> , <code>fseek_unlocked()</code>	No
<code>ftello()</code> or <code>ftello_unlocked()</code> non-large files version	No
<code>fseeko()</code> or <code>fseeko_unlocked()</code> non-large files version	No
<code>ftello()</code> or <code>ftello_unlocked()</code> large files version	Yes
<code>fseeko()</code> or <code>fseeko_unlocked()</code> large files version	Yes
<code>flocate()</code> or <code>flocate_unlocked()</code>	Yes
<code>fldata()</code> or <code>fldata_unlocked()</code>	Yes

**Note:** AMODE 64 applications also have the above restrictions on XADDR support.

---

## Text and binary I/O in VSAM

Because VSAM is primarily record-based, this section only discusses those aspects of text and binary I/O that are specific to VSAM. For general information on text and binary I/O, refer to the respective sections in Chapter 10, “Performing OS I/O operations,” on page 83.

### Reading from text and binary I/O files

- **RRDS**

All the read functions support reading from text and binary RRDS files. `fread()` is called with a character buffer instead of an RRDS record structure.

### Writing to and updating text and binary I/O files

- **KSDS, KSDS AIX, and ESDS AIX**

z/OS XL C/C++ VSAM support for streams does not provide for writing and updating these types of data sets opened for text or binary stream I/O.

- **ESDS**

Writes are supported for ESDSs opened as binary or text streams. Updating data in an ESDS stream cannot change the length of the record in the external file. Therefore, in a binary stream:

- updates for less than the existing record length leave existing data beyond the updated length unchanged;
- updates for longer than the existing record length flow over the record boundary and update the start of the next record.

In text streams:

- updates that specify records shorter than the original record pad the updated record to the existing record length with blanks;
- updates for longer than the existing record length result in truncation, unless the original record contained only a new-line character, in which case it may be updated to contain one byte of data plus a new-line character.

- **RRDS**

`fwrite()` is called with a character buffer instead of an RRDS record structure.

Records are treated as contiguous. Once the current record is filled, the next record in the file is written to. For example, if the file consisted of only record 1, record 5, and record 28, a write would complete record 1 and then go directly to record 5.

Writing past the last record in the file is allowed, up to the maximum size of the RRDS data set. For example, if the last record in the file is record 28, the next record to be written is record 29.

Insertion of records is not supported. For example, in a file of records 1, 5, and 28, you cannot insert record 3 into the file.

### Deleting records in text and binary I/O files

`fdelrec()` is not supported for text and binary I/O in VSAM.



## Repositioning within text and binary I/O files

You can use the following functions to locate a record within a VSAM data set:

- `flocate()`
- `ftell()`, `ftello()`, `fseek()`, and `fseeko()`
- `fgetpos()` and `fsetpos()`
- `rewind()`

For complete details on these library functions, see *z/OS XL C/C++ Runtime Library Reference*.

### **flocate()**

The `flocate()` C library function can be used to reposition to the beginning of a specific record within a VSAM data set given the key, relative byte address, or the relative record number. For more information on this function, see *z/OS XL C/C++ Runtime Library Reference*.

VSAM extended addressability support includes an 8 byte RBA for use with positioning functions such as `flocate()`. `flocate()` supports RBA lengths of 4 and 8 bytes. Existing applications that use `flocate()` with a 4 byte RBA will continue unaffected, but must use a key length of 8 to locate an RBA beyond 4GB.

The following `flocate()` parameters set the direction access to forward:

- `__KEY_FIRST` (the `key` and `key_len` parameters are ignored)
- `__KEY_EQ`
- `__KEY_GE`
- `__RBA_EQ`

The following `flocate()` parameters all set the access direction to backward and are not valid for text and binary I/O, because backwards access is not supported:

- `__KEY_LAST` (the `key` and `key_len` parameters are ignored)
- `__KEY_EQ_BWD`
- `__RBA_EQ_BWD`

You can use the `rewind()` library function instead of calling `flocate()` with `__KEY_FIRST`.

#### • **KSDS, KSDS AIX, and ESDS AIX**

The `key` parameter of `flocate()` for the options `__KEY_EQ` and `__KEY_GE` is a pointer to the key of reference of the data set. The `key_len` parameter is the key length as defined for the data set for a full key search, or less than the defined key length for a generic key search (a partial key match).

Alternate indexes do not allow positioning by RBA.

**Note:** The `__RBA_EQ` parameter is not valid for paths and is not recommended.

#### • **ESDS**

The `key` parameter of `flocate()` is a pointer to the specified RBA value. The `key_len` parameter is either 4 or 8 depending on the size of the RBA.

#### • **RRDS**

For `__KEY_EQ` and `__KEY_GE`, the `key` parameter of `flocate()` is a pointer to an unsigned long integer containing the specified relative record number. The `key_len` parameter is `sizeof(unsigned long)`. For `__RBA_EQ`, the `key` parameter of `flocate()` is a pointer to the specified RBA. However, seeking to RBA values is



not recommended, because it is not supported across control intervals. The `key_len` parameter is either 4 or 8 depending on the size of the RBA.

### **fgetpos() and fsetpos()**

`fgetpos()` saves the access direction, an RBA value, and the file position, and `fsetpos()` restores the saved access direction. `fgetpos()` accounts for the presence of characters in the `ungetc()` buffer unless you have set the `_EDC_COMPAT` variable. See Chapter 32, "Using environment variables," on page 467 for information about `_EDC_COMPAT`. If `ungetc()` characters back the file position up to before the start of the file, calls to `fgetpos()` fail.

- **KSDS**

`fgetpos()` stores the RBA value. This RBA value may be invalidated by subsequent insertions, deletions or updates.

- **KSDS PATH and ESDS PATH**

`fgetpos()` and `fsetpos()` are not supported for PATHs.

- **ESDS and RRDS**

There are no special considerations.

### **ftell() and fseek()**

Using `fseek()` to seek beyond the current end of file in a writable ESDS or RRDS binary file results in the file being extended with nulls to the new position. An incomplete last record is completed with nulls, records of length `lrecl` are added as required, and the current record is filled with the remaining number of nulls and left in the current buffer. This is supported for relative byte offset from `SEEK_SET`, `SEEK_CUR` and `SEEK_END`.

For AMODE 31 applications repositioning within a VSAM data set, users of `ftell()` and `fseek()` that need to access positions beyond 4GB, must use the large file version of `ftello()` and `fseeko()`.

Table 29 provides a summary of the `fseek()` and `ftell()` parameters in binary and text.

*Table 29. Summary of `fseek()` and `ftell()` parameters in text and binary*

Type	Mode	<code>ftell()</code> return values	<code>fseek()</code> SEEK_SET	SEEK_CUR	SEEK_END
KSDS	Binary	relative byte offset	relative byte offset	relative byte offset	relative byte offset
	Text	not supported	zero only	relative byte offset	relative byte offset
ESDS	Binary	relative byte offset	relative byte offset	relative byte offset	relative byte offset
	Text	not supported	zero only	relative byte offset	relative byte offset
RRDS	Binary	encoded byte offset	encoded byte offset	relative byte offset	relative byte offset
	Text	encoded byte offset	encoded byte offset	relative byte offset	relative byte offset
PATH	Binary	not supported	not supported	not supported	not supported
	Text	not supported	not supported	not supported	not supported

## **Flushing buffers**

You can use the C library function `fflush()` to flush data.

For text files, calling `fflush()` to flush an update to a record causes the new data to be written to the file.

If you call `fflush()` while you are updating, the updates are flushed out to VSAM.

For more information on `fflush()`, see *z/OS XL C/C++ Runtime Library Reference*.

## Summary of VSAM text I/O operations

Table 30 summarizes the VSAM text I/O operations.

Table 30. Summary of VSAM text I/O operations

	KSDS	ESDS	RRDS	PATH
<code>fopen()</code> , <code>freopen()</code>	r	r, r+, a, a+, w, w+ (empty cluster or reuse specified for w & w+)	r, r+, a, a+, w, w+ (empty cluster or reuse specified for w & w+)	r
<code>fwrite()</code> , <code>fwrite_unlocked()</code>		r+, a, a+, w, w+	r+, a, a+, w, w+	
<code>fprintf()</code> , <code>fprintf_unlocked()</code>		r+, a, a+, w, w+	r+, a, a+, w, w+	
<code>fputs()</code> , <code>fputs_unlocked()</code>		r+, a, a+, w, w+	r+, a, a+, w, w+	
<code>fputc()</code> , <code>fputc_unlocked()</code>		r+, a, a+, w, w+	r+, a, a+, w, w+	
<code>putc()</code> , <code>putc_unlocked()</code>		r+, a, a+, w, w+	r+, a, a+, w, w+	
<code>vfprintf()</code> , <code>vfprintf_unlocked()</code>		r+, a, a+, w, w+	r+, a, a+, w, w+	
<code>vprintf()</code> , <code>vprintf_unlocked()</code>		r+, a, a+, w, w+	r+, a, a+, w, w+	
<code>fread()</code> , <code>fread_unlocked()</code>	r	r, r+, a+, w+	r, r+, a+, w+	r
<code>fscanf()</code> , <code>fscanf_unlocked()</code>	r	r, r+, a+, w+	r, r+, a+, w+	r
<code>vfscanf()</code> , <code>vfscanf_unlocked()</code>	r	r, r+, a+, w+	r, r+, a+, w+	r
<code>fgets()</code> , <code>fgets_unlocked()</code>	r	r, r+, a+, w+	r, r+, a+, w+	r
<code>fgetc()</code> , <code>fgetc_unlocked()</code>	r	r, r+, a+, w+	r, r+, a+, w+	r
<code>getc()</code> , <code>getc_unlocked()</code>	r	r, r+, a+, w+	r, r+, a+, w+	r
<code>ungetc()</code> , <code>ungetc_unlocked()</code>	r	r, r+, a+, w+	r, r+, a+, w+	r
<code>ftell()</code> , <code>ftell_unlocked()</code>			r, r+, a, a+, w, w+	
<code>ftello()</code> , <code>ftello_unlocked()</code>			r, r+, a, a+, w, w+	
<code>fseek()</code> , <code>fseek_unlocked()</code>	r	r, r+, a, a+, w, w+	r, r+, a, a+, w, w+	
<code>fseeko()</code> , <code>fseeko_unlocked()</code>	r	r, r+, a, a+, w, w+	r, r+, a, a+, w, w+	
<code>fgetpos()</code> , <code>fgetpos_unlocked()</code>	r	r, r+, a, a+, w, w+	r, r+, a, a+, w, w+	
<code>fsetpos()</code> , <code>fsetpos_unlocked()</code>	r	r, r+, a, a+, w, w+	r, r+, a, a+, w, w+	
<code>flocate()</code> , <code>flocate_unlocked()</code>	r	r, r+, a+, w+	r, r+, a+, w+	r
<code>rewind()</code> , <code>rewind_unlocked()</code>	r	r, r+, a, a+, w, w+	r, r+, a, a+, w, w+	r
<code>fflush()</code> , <code>fflush_unlocked()</code>	r	r, r+, a, a+, w, w+	r, r+, a, a+, w, w+	r
<code>ferror()</code> , <code>ferror_unlocked()</code>	r	r, r+, a, a+, w, w+	r, r+, a, a+, w, w+	r
<code>fdelrec()</code> , <code>fdelrec_unlocked()</code>				
<code>fupdate()</code> , <code>fupdate_unlocked()</code>				
<code>feof()</code> , <code>feof_unlocked()</code>	r	r, r+, a, a+, w, w+	r, r+, a, a+, w, w+	r
<code>clearerr()</code> , <code>clearerr_unlocked()</code>	r	r, r+, a, a+, w, w+	r, r+, a, a+, w, w+	r
<code>fclose()</code>	r	r, r+, a, a+, w, w+	r, r+, a, a+, w, w+	r
<code>fldata()</code> , <code>fldata_unlocked()</code>	r	r, r+, a, a+, w, w+	r, r+, a, a+, w, w+	r

## Summary of VSAM binary I/O operations

Table 31 summarizes the VSAM binary I/O operations.

Table 31. Summary of VSAM binary I/O operations

	KSDS	ESDS	RRDS	PATH
fopen(), freopen()	rb	rb, rb+, ab, ab+, wb, wb+ (empty cluster or reuse specified for wb & wb+)	rb, rb+, ab, ab+, wb, wb+ (empty cluster or reuse specified for wb & wb+)	rb
fwrite(), fwrite_unlocked()		rb+, ab, ab+, wb, wb+	rb+, ab, ab+, wb, wb+	
fprintf(), fprintf_unlocked()		rb+, ab, ab+, wb, wb+	rb+, ab, ab+, wb, wb+	
fputs(), fputs_unlocked()		rb+, ab, ab+, wb, wb+	rb+, ab, ab+, wb, wb+	
fputc(), fputc_unlocked()		rb+, ab, ab+, wb, wb+	rb+, ab, ab+, wb, wb+	
putc(), putc_unlocked()		rb+, ab, ab+, wb, wb+	rb+, ab, ab+, wb, wb+	
vfprintf(), vfprintf_unlocked()		rb+, ab, ab+, wb, wb+	rb+, ab, ab+, wb, wb+	
vprintf(), vprintf_unlocked()		rb+, ab, ab+, wb, wb+	rb+, ab, ab+, wb, wb+	
fread(), fread_unlocked()	rb	rb, rb+, ab+, wb+	rb, rb+, ab+, wb+	rb
fscanf(), fscanf_unlocked()	rb	rb, rb+, ab+, wb+	rb, rb+, ab+, wb+	rb
vfscanf(), vfscanf_unlocked()	rb	rb, rb+, ab+, wb+	rb, rb+, ab+, wb+	rb
fgets(), fgets_unlocked()	rb	rb, rb+, ab+, wb+	rb, rb+, ab+, wb+	rb
fgetc(), fgetc_unlocked()	rb	rb, rb+, ab+, wb+	rb, rb+, ab+, wb+	rb
getc()	rb	rb, rb+, ab+, wb+	rb, rb+, ab+, wb+	rb
getc_unlocked()	rb	rb, rb+, ab+, wb+	rb, rb+, ab+, wb+	rb
ungetc(), ungetc_unlocked()	rb	rb, rb+, ab+, wb+	rb, rb+, ab+, wb+	rb
ftell(), ftell_unlocked()	rb	rb, rb+, ab, ab+, wb, wb+	rb, rb+, ab, ab+, wb, wb+	
ftello(), ftello_unlocked()	rb	rb, rb+, ab, ab+, wb, wb+	rb, rb+, ab, ab+, wb, wb+	
fseek(), fseek_unlocked()	rb	rb, rb+, ab, ab+, wb, wb+	rb, rb+, ab, ab+, wb, wb+	
fseeko(), fseeko_unlocked()	rb	rb, rb+, ab, ab+, wb, wb+	rb, rb+, ab, ab+, wb, wb+	
fgetpos(), fgetpos_unlocked()	rb	rb, rb+, ab, ab+, wb, wb+	rb, rb+, ab, ab+, wb, wb+	
fsetpos(), fsetpos_unlocked()	rb	rb, rb+, ab, ab+, wb, wb+	rb, rb+, ab, ab+, wb, wb+	
flocate(), flocate_unlocked()	rb	rb, rb+, ab+, wb+	rb, rb+, ab+, wb+	rb
rewind(), rewind_unlocked()	rb	rb, rb+, ab, ab+, wb, wb+	rb, rb+, ab, ab+, wb, wb+	rb
fflush(), fflush_unlocked()	rb	rb, rb+, ab, ab+, wb, wb+	rb, rb+, ab, ab+, wb, wb+	rb
ferror(), ferror_unlocked()	rb	rb, rb+, ab, ab+, wb, wb+	rb, rb+, ab, ab+, wb, wb+	rb
fdelrec(), fdelrec_unlocked()				
fupdate(), fupdate_unlocked()				
feof(), feof_unlocked()	rb	rb, rb+, ab, ab+, wb, wb+	rb, rb+, ab, ab+, wb, wb+	rb
clearerr(), clearerr_unlocked()	rb	rb, rb+, ab, ab+, wb, wb+	rb, rb+, ab, ab+, wb, wb+	rb
fclose()	rb	rb, rb+, ab, ab+, wb, wb+	rb, rb+, ab, ab+, wb, wb+	rb
fldata(), fldata_unlocked()	rb	rb, rb+, ab, ab+, wb, wb+	rb, rb+, ab, ab+, wb, wb+	rb

## Closing VSAM data sets

To close a VSAM data set, use the Standard C `fclose()` library function as you would for closing non-VSAM files. See *z/OS XL C/C++ Runtime Library Reference* for more details on the `fclose()` library function.

For ESDS binary files, if `fclose()` is called and there is a new record in the buffer that is less than the maximum record size, this record is written to the file at its

current size. A new RRDS binary record that is incomplete when the file is closed is filled with null characters to the record size.

A new ESDS or RRDS text record that is incomplete when the file is closed is completed with a new-line.

---

## VSAM return codes

When failing return codes are received from z/OS XL C/C++ VSAM I/O functions, you can access the `__amrc` structure to help you diagnose errors. The `__amrc_type` structure is defined in the header file `stdio.h` (when the compiler option `LANGVLV(LIBEXT)` is used).

**Note:** The `__amrc` struct is global and can be reset by another I/O operation (such as `printf()`).

The following fields of the structure are important to VSAM users:

`__amrc.__code.__feedback.__rc`  
Stores the VSAM R15.

`__amrc.__code.__feedback.__fdbk`  
Stores the VSAM error code or reason code.

`__amrc.__RBA`  
Stores the RBA after some operations. The `__amrc.__RBA` field is defined as an unsigned int, and therefore will only contain a 4-byte RBA value. This field will be set to -1 when the RBA is beyond 4GB in an extended addressable VSAM data set. In this case, the `__XRBA` field should be used.

`__amrc.__XRBA`  
The 8 byte relative byte address returned by VSAM after an ESDS or KSDS record is written out. For an RRDS, it is the calculated value from the record number. It may be used in subsequent calls to `flocate()`.

`__amrc.__last_op`  
Stores a code for the last operation. The codes are defined in the header file `stdio.h`.

`__amrc.__rp1fdbwd`  
Stores the feedback code from the IFGRPL control block.

For definitions of these return codes and feedback codes, refer to the publications listed in “DFSMS” on page 1176.

You can set up a SIGIOERR handler to catch read or write system errors. See Chapter 18, “Debugging I/O programs,” on page 223 for more information.

---

## VSAM examples

This section provides several examples of using I/O under VSAM.

### KSDS example

The example in Figure 26 on page 179 shows a sample program (CCNGVS2) with two functions from an employee record entry system with a mainline driver to process selected options (display, display next, update, delete, create). The update routine is an example of KSDS clusters, and the display routine is an example of both KSDS clusters and alternate indexes.

For these examples, the clusters and alternate indexes should be defined as follows:

- The KSDS cluster has a record size of 150 with a key length of 4 with offset 0.
- The unique KSDS AIX has a key length of 20 with an offset of 10.
- The non-unique KSDS AIX has a key length of 40 with an offset of 30.

The update routine is passed the following:

- `data_ptr`, which points to the information that is to be updated
- `orig_data_ptr`, which points to the information that was originally displayed using the display option
- A file pointer to the KSDS cluster

The display routine is passed the following:

- `data_ptr`, which points to the information that was entered on the screen for the search query
- `orig_data_ptr`, which is returned with the information for the record to be displayed if it exists
- File pointers for the primary cluster, unique alternate index and non-unique alternate index

By definition, the primary key is unique and therefore the employee number was chosen for this key. The `user_id` is also a unique key; therefore, it was chosen as the unique alternate index key. The name field may not be unique; therefore, it was chosen as the non-unique alternate index key.

```

/* this example demonstrates the use of a KSDS file */
/* part 1 of 2-other file is CCNGVS3 */

#include <stdio.h>
#include <string.h>

/* global definitions */

struct data_struct {
    char emp_number[4];
    char user_id[8];
    char name[20];
    char pers_info[37];
};

#define REC_SIZE 69
#define CLUS_KEY_SIZE 4
#define AIX_UNIQUE_KEY_SIZE 8
#define AIX_NONUNIQUE_KEY_SIZE 20

static void print_amrc() {
    __amrc_type currErr = *__amrc; /* copy contents of __amrc */
    /* structure so that values */
    /* don't get jumbled by printf */
    printf("R15 value = %d\n", currErr.__code.__feedback.__rc);
    printf("Reason code = %d\n", currErr.__code.__feedback.__fdbk);
    printf("RBA = %d\n", currErr.__RBA);
    printf("Last op = %d\n", currErr.__last_op);
    return;
}

/* update_emp_rec() function definition */

int update_emp_rec (struct data_struct *data_ptr,
                   struct data_struct *orig_data_ptr,
                   FILE *fp)
{
    int rc;
    char buffer[REC_SIZE+1];

```

*KSDS example (Part 1 of 5)*

*Figure 26. KSDS example*

```

/* Check to see if update will change primary key (emp_number) */
    if (memcmp(data_ptr->emp_number,orig_data_ptr->emp_number,4) !=
0) {
    /* Check to see if changed primary key exists */
    rc = flocate(fp,&(data_ptr->emp_number),CLUS_KEY_SIZE,__KEY_EQ);
    if (rc == 0) {
        print_amrc();
        printf("Error: new employee number already exists\n");
        return 10;
    }

    clearerr(fp);

    /* Write out new record */
    rc = fwrite(data_ptr,1,REC_SIZE,fp);
    if (rc != REC_SIZE || ferror(fp)) {
        print_amrc();
        printf("Error: write with new employee number failed\n");
        return 20;
    }

    /* Locate to old employee record so it can be deleted */
    rc = flocate(fp,&(orig_data_ptr->emp_number),CLUS_KEY_SIZE,
        __KEY_EQ);
    if (rc != 0) {
        print_amrc();
        printf("Error: flocate to original employee number failed\n");
        return 30;
    }

    rc = fread(buffer,1,REC_SIZE,fp);
    if (rc != REC_SIZE || ferror(fp)) {
        print_amrc();
        printf("Error: reading old employee record failed\n");
        return 40;
    }

    rc = fdelrec(fp);
    if (rc != 0) {
        print_amrc();
        printf("Error: deleting old employee record failed\n");
        return 50;
    }
} /* end of checking for change in primary key */
else { /* Locate to current employee record */
    rc = flocate(fp,&(data_ptr->emp_number),CLUS_KEY_SIZE,__KEY_EQ);
    if (rc == 0) {
        /* record exists, so update it */
        rc = fread(buffer,1,REC_SIZE,fp);
        if (rc != REC_SIZE || ferror(fp)) {
            print_amrc();
            printf("Error: reading old employee record failed\n");
            return 60;
        }
        rc = fupdate(data_ptr,REC_SIZE,fp);
        if (rc == 0) {
            print_amrc();
            printf("Error: updating new employee record failed\n");
            return 70;
        }
    }
}

```

*KSDS example (Part 2 of 5)*

```

else { /* record doesn't exist so write out new record */
    clearerr(fp);
    printf("Warning: record previously displayed no longer\n");
    printf("      : exists, new record being created\n");
    rc = fwrite(data_ptr,1,REC_SIZE,fp);
    if (rc != REC_SIZE || ferror(fp)) {
        print_amrc();
        printf("Error: write with new employee number failed\n");
        return 80;
    }
}
}
return 0;
}

/* display_emp_rec() function definition */

int display_emp_rec (struct data_struct *data_ptr,
                    struct data_struct *orig_data_ptr,
                    FILE *clus_fp, FILE *aix_unique_fp,
                    FILE *aix_non_unique_fp)
{
    int    rc = 0;
    char   buffer[REC_SIZE+1];

    /* Primary Key Search */
    if (memcmp(data_ptr->emp_number, "\0\0\0\0", 4) != 0) {
        rc = flocate(clus_fp,&(data_ptr->emp_number),CLUS_KEY_SIZE,
                    _KEY_EQ);
        if (rc != 0) {
            printf("Error: flocate with primary key failed\n");
            return 10;
        }

        /* Read record for display */
        rc = fread(orig_data_ptr,1,REC_SIZE,clus_fp);
        if (rc != REC_SIZE || ferror(clus_fp)) {
            printf("Error: reading employee record failed\n");
            return 15;
        }
    }

    /* Unique Alternate Index Search */
    else if (data_ptr->user_id[0] != '\0') {
        rc = flocate(aix_unique_fp,data_ptr->user_id,AIX_UNIQUE_KEY_SIZE,
                    _KEY_EQ);
        if (rc != 0) {
            printf("Error: flocate with user id failed\n");
            return 20;
        }

        /* Read record for display */
        rc = fread(orig_data_ptr,1,REC_SIZE,aix_unique_fp);
        if (rc != REC_SIZE || ferror(aix_unique_fp)) {
            printf("Error: reading employee record failed\n");
            return 25;
        }
    }
}

```

*KSDS example (Part 3 of 5)*



```

/* Non-unique Alternate Index Search */
else if (data_ptr->name[0] != '\0') {
    rc = flocate(aix_non_unique_fp,data_ptr->name,
                AIX_NONUNIQUE_KEY_SIZE,__KEY_GE);
    if (rc != 0) {
        printf("Error: flocate with name failed\n");
        return 30;
    }

    /* Read record for display */
    rc = fread(orig_data_ptr,1,REC_SIZE,aix_non_unique_fp);
    if (rc != REC_SIZE || ferror(aix_non_unique_fp)) {
        printf("Error: reading employee record failed\n");
        return 35;
    }
}
else {
    printf("Error: invalid search argument; valid search arguments\n"
           "      : are either employee number, user id, or name\n");
    return 40;
}
/* display record data */
printf("Employee Number: %.4s\n", orig_data_ptr->emp_number);
printf("Employee Userid: %.8s\n", orig_data_ptr->user_id);
printf("Employee Name:   %.20s\n", orig_data_ptr->name);
printf("Employee Info:   %.37s\n", orig_data_ptr->pers_info);
return 0;
}
/* main() function definition */

int main() {
    FILE*          clus_fp;
    FILE*          aix_ufp;
    FILE*          aix_nufp;
    int            i;
    struct data_struct buf1, buf2;

    char data[3][REC_SIZE+1] = {
" 1LARRY  LARRY          HI, I'M LARRY,      ",
" 2DARRYL1 DARRYL      AND THIS IS MY BROTHER DARRYL, ",
" 3DARRYL2 DARRYL      "
    };

    /* open file three ways */
    clus_fp = fopen("dd:cluster", "rb+,type=record");
    if (clus_fp == NULL) {
        print_amrc();
        printf("Error: fopen(\"dd:cluster\"...) failed\n");
        return 5;
    }

    /* assume base cluster was loaded with at least one dummy record */
    /* so aix could be defined */
    aix_ufp = fopen("dd:aixuniq", "rb,type=record");
    if (aix_ufp == NULL) {
        print_amrc();
        printf("Error: fopen(\"dd:aixuniq\"...) failed\n");
        return 10;
    }

    /* assume base cluster was loaded with at least one dummy record */
    /* so aix could be defined */
    aix_nufp = fopen("dd:aixnuniq", "rb,type=record");

```

*KSDS example (Part 4 of 5)*

```

if (aix_nufp == NULL) {
    print_amrc();
    printf("Error: fopen(\"dd:aixnuniq\"...) failed\n");
    return 15;
}

/* load sample records */
for (i = 0; i < 3; ++i) {
    if (fwrite(data[i],1,REC_SIZE,clus_fp) != REC_SIZE) {
        print_amrc();
        printf("Error: fwrite(data[%d]...) failed\n", i);
        return 66+i;
    }
}

/* display sample record by primary key */
memcpy(buf1.emp_number, " 1", 4);
if (display_emp_rec(&buf1, &buf2, clus_fp, aix_ufp, aix_nufp) != 0)
    return 69;

/* display sample record by nonunique aix key */
memset(buf1.emp_number, '\0', 4);
buf1.user_id[0] = '\0';
memcpy(buf1.name, "DARRYL", 20);
if (display_emp_rec(&buf1, &buf2, clus_fp, aix_ufp, aix_nufp) != 0)
    return 70;

/* display sample record by unique aix key */
memcpy(buf1.user_id, "DARRYL2 ", 8);
if (display_emp_rec(&buf1, &buf2, clus_fp, aix_ufp, aix_nufp) != 0)
    return 71;

/* update record just read with new personal info */
memcpy(&buf1, &buf2, REC_SIZE);
memcpy(buf1.pers_info, "AND THIS IS MY OTHER BROTHER DARRYL. ", 37);
if (update_emp_rec(&buf1, &buf2, clus_fp) != 0) return 72;

/* display sample record by unique aix key */
if (display_emp_rec(&buf1, &buf2, clus_fp, aix_ufp, aix_nufp) != 0)
    return 73;

return 0;
}

```

***KSDS example (Part 5 of 5)***

The JCL in the sample code (CCNGVS3) in Figure 27 on page 184 can be used to test the example code in Figure 26 on page 179.

```

/** this example illustrates the use of a KSDS file
/** part 2 of 2-other file is CCNGVS2
/**-----
/** Delete cluster, and AIX and PATH
/**-----
//DELETED EXEC PGM=IDCAMS
//SYSPRINT DD SYSOUT=*
//SYSIN DD *
DELETE -
    userid.KSDS.CLUSTER -
    CLUSTER -
    PURGE -
    ERASE
/**-----
/** Define KSDS
/**-----
//DEFINE EXEC PGM=IDCAMS
//VOLUME DD UNIT=SYSDA,DISP=SHR,VOL=SER=(XXXXXX)
//SYSPRINT DD SYSOUT=*
//SYSIN DD *
DEFINE CLUSTER -
    (NAME(userid.KSDS.CLUSTER) -
    FILE(VOLUME) -
    VOL(XXXXXX) -
    TRK(4 4) -
    RECSZ(69 100) -
    INDEXED -
    NOREUSE -
    KEYS(4 0) -
    OWNER(userid) ) -
DATA -
    (NAME(userid.KSDS.DA)) -
INDEX -
    (NAME(userid.KSDS.IX))
/**

```

*KSDS example (Part 1 of 3)*

*Figure 27. KSDS example*

```

/*-----
/* Repro data into KSDS
/*-----
//REPRO EXEC PGM=IDCAMS
//SYSPRINT DD SYSOUT=*
//SYSIN DD *
      REPRO INDATASET(userid.DUMMY.DATA) -
            OUTDATASET(userid.KSDS.CLUSTER)
/*
/*-----
/* Define unique AIX, define and build PATH
/*-----
//DEFAIX EXEC PGM=IDCAMS
//SYSPRINT DD SYSOUT=*
//SYSIN DD *
      DEFINE AIX -
        (NAME(userid.KSDS.UAIX) -
         RECORDS(25) -
         KEYS(8,4) -
         VOL(XXXXXX) -
         UNIQUEKEY -
         RELATE(userid.KSDS.CLUSTER)) -
        DATA -
        (NAME(userid.KSDS.UAIXDA)) -
        INDEX -
        (NAME(userid.KSDS.UAIXIX))
      DEFINE PATH -
        (NAME(userid.KSDS.UPATH) -
         PATHENTRY(userid.KSDS.UAIX))
      BLDINDEX -
        INDATASET(userid.KSDS.CLUSTER) -
        OUTDATASET(userid.KSDS.UAIX)
/*

```

*KSDS example (Part 2 of 3)*

```

/*-----
/* Define nonunique AIX, define and build PATH
/*-----
//DEFAIX EXEC PGM=IDCAMS
//SYSPRINT DD SYSOUT=*
//SYSIN DD *
  DEFINE AIX -
    (NAME(userid.KSDS.NUAIX) -
    RECORDS(25) -
    KEYS(20, 12) -
    VOL(XXXXXX) -
    NONUNIQUEKEY -
    RELATE(userid.KSDS.CLUSTER)) -
  DATA -
    (NAME(userid.KSDS.NUAIXDA)) -
  INDEX -
    (NAME(userid.KSDS.NUAIXIX))
  DEFINE PATH -
    (NAME(userid.KSDS.NUPATH) -
    PATHENTRY(userid.KSDS.NUAIX))
  BLDINDEX -
    INDATASET(userid.KSDS.CLUSTER) -
    OUTDATASET(userid.KSDS.NUAIX)

/*
/*-----
/* Run the testcase
/*-----
//GO EXEC PGM=CCNGVS2,REGION=5M
//STEPLIB DD DSN=userid.TEST.LOAD,DISP=SHR
// DD DSN=CEE.SCEERUN,DISP=SHR
//SYSPRINT DD SYSOUT=*
//SYSTEM DD SYSOUT=*
//SYSOUT DD SYSOUT=*
//PLIDUMP DD SYSOUT=*
//SYSABEND DD SYSOUT=*
//SYSUDUMP DD SYSOUT=*
//CLUSTER DD DSN=userid.KSDS.CLUSTER,DISP=SHR
//AIXUNIQ DD DSN=userid.KSDS.UPATH,DISP=SHR
//AIXNUNIQ DD DSN=userid.KSDS.NUPATH,DISP=SHR
/*-----
/* Print out the cluster
/*-----
//PRINTF EXEC PGM=IDCAMS
//SYSPRINT DD SYSOUT=*
//SYSIN DD *
  PRINT -
    INDATASET(userid.KSDS.CLUSTER) CHAR
/*

```

*KSDS example (Part 3 of 3)*

## RRDS example

The sample program (CCNGVS4) in Figure 28 on page 187 illustrates the use of an RRDS file. It performs the following operations:

1. Opens an RRDS file in record mode (the cluster must be defined)
2. Writes three records (RRN 2, RRN 10, and RRN 32)
3. Sets the file position to the first record
4. Reads the first record in the file
5. Deletes it
6. Locates the last record in the file and sets the access direction to backwards
7. Reads the record

8. Updates the record
9. Sets the `_EDC_RRDS_HIDE_KEY` environment variable
10. Reads the next record in sequence (RRN 10) into a character string

```

/* this example illustrates the use
of an RRDS file */

#include <stdio.h>
#include <stdlib.h>
#include <string.h>
#include <env.h>

struct rrds_struct {
    rrds_key_type  rrds_key;
    char          *rrds_buf;
};

typedef struct rrds_struct RRDS_STRUCT;

main() {

FILE          *fileptr;
RRDS_STRUCT  RRDSstruct;
RRDS_STRUCT  *rrds_rec = &RRDSstruct;
char         buffer1[80] =
            "THIS IS THE FIRST RECORD IN THE FILE. I"
            "T WILL BE WRITTEN AT RRN POSITION 2.  ";
char         buffer2[80] =
            "THIS IS THE SECOND RECORD IN THE FILE. I"
            "T WILL BE WRITTEN AT RRN POSITION 10.  ";
char         buffer3[80] =
            "THIS IS THE THIRD RECORD IN THE FILE. I"
            "T WILL BE WRITTEN AT RRN POSITION 32.  ";
char         outputbuf[80];
unsigned long flocate_key = 0;

/*-----*/
/* select RRDS record structure 2 by setting __fill to 1 */
/*-----*/
/* 1. open an RRDS file record mode (the cluster must be defined) */
/* 2. write three records (RRN 2, RRN 10, RRN 32) */
/*-----*/
    rrds_rec->rrds_key.__fill = 1;

    fileptr = fopen("DD:RRDSFILE", "wb+,type=record");
    if (fileptr == NULL) {
        perror("fopen");
        exit(99);
    }
    rrds_rec->rrds_key.__recnum = 2;
    rrds_rec->rrds_buf = buffer1;
    fwrite(rrds_rec,1,88, fileptr);

    rrds_rec->rrds_key.__recnum = 10;
    rrds_rec->rrds_buf = buffer2;
    fwrite(rrds_rec,1,88, fileptr);

    rrds_rec->rrds_key.__recnum = 32;
    rrds_rec->rrds_buf = buffer3;
    fwrite(rrds_rec,1,88, fileptr);

```

*RRDS example (Part 1 of 2)*

*Figure 28. RRDS example*

```

/*-----*/
/* 3. set file position to the first record */
/* 4. read the first record in the file */
/* 5. delete it */
/*-----*/
    flocate(fileptr, &flocate_key, sizeof(unsigned long), __KEY_FIRST);

    memset(outputbuf,0x00,80);
    rrd_rec->rrds_buf = outputbuf;

    fread(rrd_rec,1, 88, fileptr);
    printf("The first record in the file (this will be deleted):\n");
    printf("RRN %d: %s\n\n",rrd_rec->rrds_key.__recnum,outputbuf);

    fdelrec(fileptr);

/*-----*/
/* 6. locate last record in file and set access direction backwards*/
/* 7. read the record */
/* 8. update the record */
/*-----*/
    flocate(fileptr, &flocate_key, sizeof(unsigned long), __KEY_LAST);

    memset(outputbuf,0x00,80);
    rrd_rec->rrds_buf = outputbuf;

    fread(rrd_rec,1, 88, fileptr);
    printf("The last record in the file (this one will be updated):\n");
    printf("RRN %d: %s\n\n",rrd_rec->rrds_key.__recnum,outputbuf);

    memset(outputbuf,0x00,80);
    memcpy(outputbuf,"THIS IS THE UPDATED STRING... ",30);
    fupdate(rrd_rec,88,fileptr);

/*-----*/
/* 9. set _EDC_RRDS_HIDE_KEY environment variable */
/* 10. read the next record in sequence (ie. RRN 10) into a */
/*     + character string */
/*-----*/

    setenv("_EDC_RRDS_HIDE_KEY","Y",1);
    memset(outputbuf,0x00,80);
    fread(outputbuf, 1, 80, fileptr);
    printf("The middle record in the file (read into char string):\n");
    printf("%80s\n\n",outputbuf);

    fclose(fileptr);
}

```

*RRDS example (Part 2 of 2)*

---

## **fldata() behavior**

The format of the `fldata()` function is as follows:

```
int fldata(FILE *file, char *filename, fldata_t *info);
```

The `fldata()` function is used to retrieve information about an open stream. The name of the file is returned in *filename* and other information is returned in the `fldata_t` structure, shown in Figure 29 on page 189. Values specific to this category of I/O are shown in the comment beside the structure element. Other notes about this category of I/O follow the figure. For more information on the `fldata()`

function, see *z/OS XL C/C++ Runtime Library Reference*.

---

```

struct __fileData {
    unsigned int    __recfmF    : 1, /* */
                  __recfmV    : 1, /* */
                  __recfmU    : 1, /* */
                  __recfmS    : 1, /* always off */
                  __recfmBlk  : 1, /* always off */
                  __recfmASA   : 1, /* always off */
                  __recfmM    : 1, /* always off */
                  __dsorgPO    : 1, /* N/A -- always off */
                  __dsorgPDSmem : 1, /* N/A -- always off */
                  __dsorgPDSdir : 1, /* N/A -- always off */
                  __dsorgPS    : 1, /* N/A -- always off */
                  __dsorgConcat : 1, /* N/A -- always off */
                  __dsorgMem   : 1, /* N/A -- always off */
                  __dsorgHiper : 1, /* N/A -- always off */
                  __dsorgTemp  : 1, /* N/A -- always off */
                  __dsorgVSAM  : 1, /* always on */

    #if __TARGET_LIB__ >= __EDC_LE /* */
        __dsorgHFS : 1, /* */
    #else
        __reserve1 : 1, /* */
    #endif
    __openmode : 2, /* one of: */
                /* __TEXT */
                /* __BINARY */
                /* __RECORD */
    __modeflag : 4, /* combination of: */
                /* __READ */
                /* __WRITE */
                /* __APPEND */
                /* __UPDATE */
    __dsorgPDSE : 1, /* N/A -- always off */
    __vsamRLS  : 3, /* One of: */
                /* __NORLS */
                /* __RLS */
    #if __EDC_TARGET >= 0x41080000 /* */
        __vsamEA : 1, /* */
        __reserve2 : 4; /* */
    #else
        __reserve3 : 5; /* */
    #endif

    __device_t    __device; /* */
    unsigned long __blksize; /* */
    unsigned long __maxreclen; /* */
    union {
        struct {
            unsigned short __vsam_type; /* */
            unsigned long __vsam_keylen; /* */
            unsigned long __vsam_RKP; /* */
        } __vsam; /* */
        #if __EDC_TARGET >= 0x41080000 /* */
            struct {
                unsigned char __disk_access_method; /* */
                unsigned char __disk_noseek_to_seek; /* */
                long __disk_reserve[2]; /* */
            } __disk; /* */
        #endif
    } __device_specific;

    char * __dsname; /* */
    unsigned int __reserve4; /* */
};
typedef struct __fileData fldata_t;

```

---

Figure 29. *fldata()* structure

**Notes:**

1. If you have opened the file by its data set name, the *filename* is fully qualified, including quotation marks. If you have opened the file by ddname, *filename* is dd:ddname, without any quotation marks. The ddname is uppercase.



2. The `__dsname` field is filled in with the data set name. The `__dsname` value is uppercase unless the `asis` option was specified on the `fopen()` or `freopen()` function call.

---

## Chapter 13. Performing terminal I/O operations

This chapter describes how to use input and output interactively with a terminal (using TSO or z/OS UNIX). Terminal I/O supports text, binary, and record I/O, in undefined, variable and fixed-length formats, except that ASA format is not valid for any text terminal files.

**Note:** You cannot use the z/OS XL C/C++ I/O functions for terminal I/O under either IMS or CICS. Terminal I/O under CICS is supported through the CICS command level interface.

This chapter describes C I/O stream functions as they can be used within C++ programs. If you want to use the C++ I/O stream classes instead, see Chapter 4, “Using the Standard C++ Library I/O Stream Classes,” on page 23 for general information. For more detailed information, see *Standard C++ Library Reference*, which discusses the Standard C++ I/O stream classes.

---

### Opening files

You can use the library functions `fopen()` or `freopen()` to open a file.

#### Using `fopen()` and `freopen()`

This section covers:

- Opening a file by data set name
- Opening a file by DD name
- `fopen()` and `freopen()` keywords
- Opening a terminal file under a shell

#### Opening a file by data set name

Files are opened with a call to `fopen()` or `freopen()` in the format `fopen("filename", "mode")`. The first character of the filename must be an asterisk (\*).

**z/OS UNIX Considerations:** If you have specified `POSIX(ON)`, `fopen("*file.data", "r");` does not open a terminal file. Instead, it opens a file called `*file.data` in the UNIX file system. To open a terminal file under POSIX, you must specify two slashes before the asterisk, as follows:

```
fopen("//*file.data", "r");
```

Terminal files cannot be opened in update mode.

Terminal files opened in append mode are treated as if they were opened in write mode.

#### Opening a file by DDname

The data set name that is associated with the DD statement must be an asterisk(\*). For example:

```
TSO ALLOC f(ddname) DA(*)  
fopen("dd:ddname", "mode");
```

## fopen() and freopen() keywords

The following table lists the keywords that are available on the `fopen()` and `freopen()` functions, tells you which ones are useful for terminal I/O, and lists the values that are valid for the applicable ones.

Table 32. Keywords for the `fopen()` and `freopen()` functions for terminal I/O

Parameter	Allowed?	Applicable?	Notes
<code>recfm=</code>	Yes	Yes	F, V, U and additional keywords A, B, S, M are the valid values. A, B, S, and M are ignored.
<code>lrecl=</code>	Yes	Yes	See below.
<code>blksize=</code>	Yes	Yes	See below.
<code>space=</code>	Yes	No	Has no effect for terminal I/O.
<code>type=</code>	Yes	Yes	May be omitted. If you do specify it, <code>type=record</code> is the only valid value.
<code>acc=</code>	No	No	Not used for terminal I/O.
<code>password=</code>	No	No	Not used for terminal I/O.
<code>asis</code>	Yes	No	Has no effect for terminal I/O.
<code>byteseek</code>	Yes	No	Has no effect for terminal I/O.
<code>noseek</code>	Yes	No	Has no effect for terminal I/O.
<code>OS</code>	Yes	No	Not used for terminal I/O.

### **recfm=**

z/OS XL C/C++ allows you to specify any of the 27 possible RECFM types (listed in “Fixed-format records” on page 12, “Variable-format records” on page 16, and “Undefined-format records” on page 19). The default is `recfm=U`. Any specification of ASA for the record format is ignored.

### **lrecl= and blksize=**

The `lrecl` and `blksize` parameters allow you to set the record size and block size, respectively. The maximum limits on `lrecl` values are as follows:

**32771** For input z/OS variable terminals (data length of 32767)

**32767** For input z/OS fixed and undefined terminals

**32770** For output z/OS variable terminals (data length of 32766)

**32766** For output z/OS fixed and undefined terminals

In fixed and undefined terminal files, `blksize` is always the size of `lrecl`. In variable terminal files, `blksize` is always the size of `lrecl` plus 4 bytes. It is not necessary to specify values for `lrecl` and `blksize`. If neither is specified, the default values are used. The default `lrecl` sizes (not including the extra 4 bytes in the `lrecl` of variable length types) are as follows:

- Screen width for output terminals
- 1000 for input z/OS text terminals
- 254 for all other input terminals

### **space=**

This parameter is accepted as an option for terminal I/O, but it is ignored. It does not generate an error.

### **type=**

`type=record` specifies that the file is to be opened for sequential record I/O. The file must be opened as a binary file.

**acc=**

This parameter is not valid for terminal I/O. If you specify it, your `fopen()` call fails.

**password=**

This parameter is not valid for terminal I/O. If you specify it, your `fopen()` call fails.

**asis**

This parameter is accepted as an option for terminal I/O, but it is ignored. It does not generate an error.

**byteseek**

This parameter is accepted as an option for terminal I/O, but it is ignored. It does not generate an error.

**noseek**

This parameter is accepted as an option for terminal I/O, but it is ignored. It does not generate an error.

**OS**

This parameter is not valid for terminal I/O. If you specify it, your `fopen()` call fails.

When you perform input and output in an interactive mode with the terminal, all standard streams and all files with `*` as the first character of their names are associated with the terminal. Output goes to the screen; input comes from the keyboard.

An input EOF can be generated by a `/*` if you open a stream in text mode. If you open the stream in binary or record mode, you can generate an EOF by entering a null string.

ASA characters are not interpreted in terminal I/O.

**Opening a terminal file under a shell**

Files are opened with a call to `fopen()` in the format `fopen("/dev/tty", "mode")`.

## Buffering

z/OS XL C/C++ uses buffers to map byte-level I/O (data stored in records and blocks) to system-level C I/O.

In terminal I/O, line buffering is always in effect.

The `setvbuf()` and `setbuf()` functions can be used to control buffering before any read or write operation to the file. If you want to reset the buffering mode, you must call `setvbuf()` or `setbuf()` before any other operation occurs on a file, because you cannot change the buffering mode after an I/O operation to the file.

---

## Reading from files

You can use the following library functions to read in information from terminal files; see *z/OS XL C/C++ Runtime Library Reference* for more information on these library functions.

- `fread()`
- `fread_unlocked()`
- `fgets()`

- `fgets_unlocked()`
- `gets()`
- `gets_unlocked()`
- `fgetc()`
- `fgetc_unlocked()`
- `getc()`
- `getc_unlocked()`
- `getchar()`
- `getchar_unlocked()`
- `scanf()`
- `scanf_unlocked()`
- `fscanf()`
- `fscanf_unlocked()`
- `vscanf()`
- `vscanf_unlocked()`
- `vscanf()`
- `vscanf_unlocked()`

You can set up a SIGIOERR handler to catch read or write system errors. See Chapter 18, “Debugging I/O programs,” on page 223 for more information.

A call to the `rewind()` function clears unread input data in the terminal buffer so that on the next read request, the system waits for more user input.

With z/OS Language Environment, an empty record is considered EOF in binary mode or record mode. This remains in effect until a `rewind()` or `clearerr()` is issued. When the `rewind()` is issued, the buffer is cleared and reading can continue.

Under TSO, the virtual line size of the terminal is used to determine the line length.

When reading from the terminal and the RECFM has been set to be F (for example, by an ALLOCATE under TSO) in binary or record mode, the input is padded with blanks to the record length.

On input, all terminal files opened for output flush their output, no matter what type of file they are and whether a record is complete or not. This includes fixed terminal files that would normally withhold output until a record is completed, as well as text records that normally wait until a new-line or carriage return. In all cases, the data is placed into one line with a blank added to separate output from different terminal files. Fixed terminal files do not pad the output with blanks when flushing this way.

**Note:** This flush is not the same as a call to `fflush()`, because fixed terminal files do not have incomplete records and text terminal files do not output until the new-line or carriage return. This flush occurs only when actual input is required from the terminal. When data is still in the buffer, that data is read without flushing output terminal files.

## Reading from binary files

This discussion includes reading from fixed binary files and from variable or undefined binary files.

### Reading from fixed binary files

- Any input that is smaller than the record length is padded with blanks to the record length. The default record length is 254 bytes.
- The carriage return or new-line is not included as part of the data.
- An input line longer than the record length is returned to the calling program on subsequent system reads.

For example, suppose a program requests 30 bytes of user input from an input fixed binary terminal with record length 25. The full 30 bytes of user input returns to satisfy the request, so that you do not need to enter a second line of input.

- An empty input line indicates EOF.

### Reading from variable or undefined binary files

These files behave like fixed-length binary files, except that no padding is performed if the input is smaller than the record length.

## Reading from text files

This discussion includes reading from fixed text files and from variable or undefined text files.

### Reading from fixed text files

- The carriage return indicates the end of the record.
- A new-line character is added as part of the data to indicate the end of an input line.
- If the input is larger than the record length, it is truncated to the record length. The truncation causes SIGIOERR to be raised, if the default action for SIGIOERR is not SIG\_IGN.
- When an input line is smaller than the record length, it is not padded with blanks.
- The character sequence /\* indicates that the end of the file has been reached.

### Reading from variable or undefined text files

These files behave like fixed-length text files.

## Reading from record I/O files

This discussion includes reading from fixed record I/O files and from variable or undefined record I/O files.

### Reading from fixed record I/O files

- Records smaller than the record length are padded with blanks up to the record length. The default record length is 254 bytes.
- Input record terminal records have an implicit logical record boundary at the record length if the input size exceeds the record length.  
If you enter input data larger than the record length, each subsequent block of record-length bytes from the user input satisfies successive read requests.
- The carriage return or new-line is not included as part of the data.
- An empty line indicates an EOF.

## Reading from variable or undefined record I/O files

These files behave like fixed-length record files, except that no padding is performed.

---

## Writing to files

You can use the following library functions to write to a terminal file; see *z/OS XL C/C++ Runtime Library Reference* for more information on these library functions.

- `fwrite()`
- `fwrite_unlocked()`
- `printf()`
- `printf_unlocked()`
- `fprintf()`
- `fprintf_unlocked()`
- `vprintf()`
- `vprintf_unlocked()`
- `vfprintf()`
- `vfprintf_unlocked()`
- `puts()`
- `puts_unlocked()`
- `fputs()`
- `fputs_unlocked()`
- `fputc()`
- `fputc_unlocked()`
- `putc()`
- `putc_unlocked()`
- `putchar()`
- `putchar_unlocked()`

If no record length is specified for the output terminal file, it defaults to the virtual line size of the terminal.

On output, records are written one line at a time up to the record length. For all output terminal files, records are not truncated. If you are printing a long string, it wraps around to another line.

## Writing to binary files

This discussion includes writing to fixed binary files and to variable or undefined binary files.

### Writing to fixed binary files

- Output data is sent to the terminal when the last character of a record is written.
- When closing an output terminal, any unwritten data is padded to the record length with blanks before it is flushed.

### Writing to variable or undefined binary files

These files behave the same as fixed-length binary files, except that no padding occurs for output that is smaller than the record length.

## Writing to text files

The following control characters are supported:

- \a** Alarm. Causes the terminal to generate an audible beep.
- \b** Backspace. Backs up the output position by one byte. If you are at the start of the record, you cannot back up to previous record, and backspace is ignored.
- \f** Form feed. Sends any unwritten data to the terminal and clears the screen if the environment variable `_EDC_CLEAR_SCREEN` is set. If the variable is not set, the `\f` character is written to the screen.
- \n** New-line. Sends the preceding unwritten character to the terminal. If no preceding data exists, it sends a single blank character.
- \t** Horizontal tab. Pads the output record with blanks up to the next tab stop (set at eight characters).
- \v** Vertical tab. Placed in the output as is.
- \r** Carriage return. Treated as a new-line, sends preceding unwritten data to the terminal.

### Writing to fixed text files

- Lines that are longer than the record length are not truncated. They are split across multiple lines, each `LRECL` bytes long. Subsequent writes begin on a new line.
- Output data is sent to the terminal when one character more than the record length is written, or when a `\r`, `\n`, or `\f` character is written. In the case of `\f`, output is displayed only if the `_EDC_CLEAR_SCREEN` environment variable is set.
- No padding occurs on output when a record is smaller than the record length.

### Writing to variable or undefined text files

These terminal files behave like fixed-length terminal files.

## Writing to record I/O files

This discussion includes writing to fixed record I/O files and to variable or undefined record I/O files.

### Writing to fixed record I/O files

- Any output record that is smaller than the record length is padded to the record length with blanks, and trailing blanks are displayed.
- If a record is longer than the record length, all data is written to the terminal, wrapping at the record length.
- Output data is sent to the terminal with every record write.

### Writing to variable or undefined record I/O files

These files behave like fixed-length record files except that no padding occurs when the output record is smaller than the record length.

---

## Flushing records

The action taken by the `fflush()` library function depends on the file mode. The `fflush()` function only flushes buffers in binary files with Variable or Undefined record format.



If you call one z/OS XL C/C++ program from another z/OS XL C/C++ program by using the ANSI `system()` function, all open streams are flushed before control is passed to the callee, and again before control is returned to the caller. If you are running with `POSIX(0N)`, a call to the POSIX `system()` function does not flush any streams to the system.

## Text streams

- Writing a new record:  
Because a new-line character has not been encountered to indicate the end-of-line, `fflush()` takes no action. The record is written as a new record when one of the following takes place:
  - A new-line character is written.
  - The file is closed.
- Reading a record:  
`fflush()` clears a previous `ungetc()` character.

## Binary streams

- Writing a new record:  
If the file is variable or undefined length in record format, `fflush()` causes the current record to be written out, which in turn causes a new record to be created for subsequent writes. If the file is of fixed record length, no action is taken.
- Reading a record:  
`fflush()` clears a previous `ungetc()` character.

## Record I/O

- Writing a new record: `fflush()` takes no action.
- Reading a record: `fflush()` takes no action.

---

## Repositioning within files

In terminal I/O, `rewind()` is the only positioning library function available. Using the library functions `fseek()`, `fgetpos()`, `fsetpos()`, and `ftell()` generates an error. See *z/OS XL C/C++ Runtime Library Reference* for more information on these library functions.

When an input terminal reaches an EOF, the `rewind()` function:

1. Clears the EOF condition.
2. Enables the terminal to read again.

You can also use `rewind()` when reading from the terminal to flush out your record buffer for that stream.

---

## Closing files

Use the `fclose()` library function to close a file. z/OS XL C/C++ automatically closes files on normal program termination and attempts to do so under abnormal program termination or `abend`. When closing a fixed binary terminal, z/OS XL C/C++ pads the last record with blanks if it is incomplete.

See *z/OS XL C/C++ Runtime Library Reference* for more information on this library function.

---

## fldata() behavior

The format of the `fldata()` function is as follows:

The `fldata()` function is used to retrieve information about an open stream. The

```
int fldata(FILE *file, char *filename, fldata_t *info);
```

name of the file is returned in `filename` and other information is returned in the `fldata_t` structure, shown in Figure 30. Values specific to this category of I/O are shown in the comment beside the structure element. Additional notes pertaining to this category of I/O follow the figure.

For more information on the `fldata()` function, refer to *z/OS XL C/C++ Runtime Library Reference*.

---

```
struct __fileData {
    unsigned int  __recfmF : 1, /*
                    __recfmV : 1, /*
                    __recfmU : 1, /*
                    __recfmS : 1, /* always off
                    __recfmBlk : 1, /* always off
                    __recfmASA : 1, /* always off
                    __recfmM : 1, /* always off
                    __dsorgPO : 1, /* N/A -- always off
                    __dsorgPDSmem : 1, /* N/A -- always off
                    __dsorgPDSdir : 1, /* N/A -- always off
                    __dsorgPS : 1, /* N/A -- always off
                    __dsorgConcat : 1, /* N/A -- always off
                    __dsorgMem : 1, /* N/A -- always off
                    __dsorgHiper : 1, /* N/A -- always off
                    __dsorgTemp : 1, /* N/A -- always off
                    __dsorgVSAM : 1, /* N/A -- always off
                    __dsorgHFS : 1, /* N/A -- always off
                    __openmode : 2, /* one of:
                                /* __TEXT
                                /* __BINARY
                                /* __RECORD
                    __modeflag : 4, /* combination of:
                                /* __READ
                                /* __WRITE
                                /* __APPEND
                    __dsorgPDSE : 1, /* N/A -- always off
                    __reserve2 : 8; /*
    __device_t  __device; /* __TERMINAL
    unsigned long __blksize; /*
                __maxreclen; /*
    unsigned short __vsamtype; /* N/A
    unsigned long __vsamkeylen; /* N/A
    unsigned long __vsamRKP; /* N/A
    char * __dsname; /* N/A -- always NULL
    unsigned int __reserve4; /*
};
typedef struct __fileData fldata_t;
```

---

Figure 30. `fldata()` structure

### Notes:

1. The `filename` value is `dd:ddname` if the file is opened by `ddname`; otherwise, the value is `*`. The `ddname` is uppercase.
2. Either `__recfmF`, `__recfmV`, or `__recfmU` will be set according to the `recfm` parameter specified on the `fopen()` or `freopen()` function call.



---

## Chapter 14. Performing memory file and hiperspace I/O operations

This chapter describes how to perform memory file and hiperspace I/O operations. z/OS XL C/C++ supports files known as *memory files*. Memory files are temporary work files that are stored in main memory rather than in external storage. There are two types of memory files:

- Regular memory files, which exist in your virtual storage
- Hiperspace memory files, which use special storage areas called *hiperspaces*.

Memory files can be written to, read from, and repositioned within like any other type of file. Memory files exist for the life of your root program, unless you explicitly delete them by using the `remove()` or `clrmemf()` functions. The root program is the first `main()` to be invoked. Any `main()` program called by a `system()` call is known as a *child program*. When the root program terminates, z/OS XL C/C++ removes memory files automatically. Memory files may give you better performance than other types of files.

**Note:** There may not be a one-to-one correspondence between the bytes in a memory file and the bytes in some other external representation of the file, such as a disk file. Applications that mix open modes on a file (for example, writing a file as text file and reading it back as binary) may not port readily from external I/O to memory file I/O.

This chapter describes C I/O streams as they can be used within C++ programs. If you want to use the C++ I/O stream classes instead, see Chapter 4, “Using the Standard C++ Library I/O Stream Classes,” on page 23 for general information. For more detailed information, see *Standard C++ Library Reference*, which discusses the Standard C++ I/O stream classes.

---

### Using hiperspace operations

**Restriction:** Hiperspace memory files are not supported in AMODE 64 applications. Attempts to open a memory file with `type=memory(hiperspace)` will be converted to a regular memory file.

On z/OS systems, large memory files can be placed in hiperspaces to reduce memory requirements within your address space.

If your installation supports hiperspaces, and you are not using CICS, you can use hiperspace memory files (see the appropriate book as listed in *z/OS V2R2 Information Roadmap* for more information on hiperspaces). Whereas a regular memory file stores all the file data in your address space, a hiperspace memory file uses one buffer in your address space, and keeps the rest of the data in the hiperspace. Therefore, a hiperspace memory file requires only a certain amount of storage in your address space, regardless of how large the file is. If you use `setvbuf()`, z/OS XL C/C++ may or may not accept your buffer for its internal use. For a hiperspace memory file, if the size of the buffer specified to `setvbuf()` is greater than 4K, then only the first 4K of the user buffer will be used.

Hiperspace memory files may not be shared by multiple threads. A hiperspace memory file that is created on one thread can only be read/written/closed by the same thread.

## Opening files

Use the Standard C `fopen()` or `freopen()` library functions to open a memory file. Details about these functions that apply to all z/OS XL C/C++ I/O operations are discussed in Chapter 5, “Opening files,” on page 27.

### Using `fopen()` or `freopen()`

This section describes considerations for using `fopen()` and `freopen()` with memory files. Memory files are always treated as binary streams of bytes, regardless of the parameters you specify on the function call that opens them.

#### File-naming considerations

When you open a file using `fopen()` or `freopen()`, you must specify the filename (a data set name) or the ddname.

**Using a data set name:** Files are opened with a call to `fopen()` or `freopen()` in the format `fopen("filename", "mode")`. The following diagram shows the syntax for the `filename` argument on your `fopen()` or `freopen()` call:

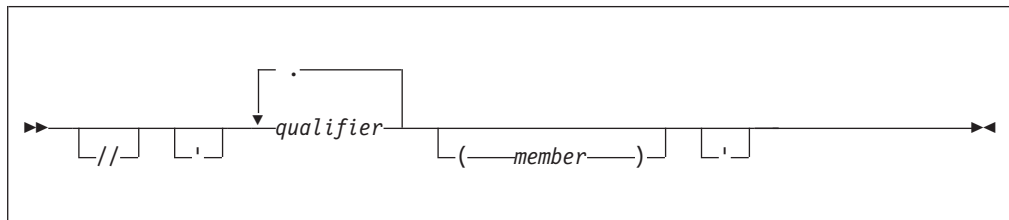

The following is a sample construct:

```
'qualifier1.qualifier2(member)'  
// Ignored for memory files.  
qualifier
```

There is no restriction on the length of each qualifier. All characters are considered valid. The total number of characters for all of the qualifiers, including periods and a TSO prefix, cannot exceed 44 characters when running POSIX(OFF). Under POSIX(ON), the TSO prefix is not added, and the total number of characters is not limited, except that the full file name, including the member, cannot exceed the limit for a POSIX pathname, currently 1024 characters.

#### (*member*)

If you specify a *member*, the data set you are opening is considered to be a simulated PDS or a PDSE. For more information about PDSs and PDSEs, see “Simulating partitioned data sets” on page 206. For members, the member name (including trailing blanks) can be up to 8 characters long. A member name cannot begin with leading blanks.

When you enclose a name in single quotation marks, the name is *fully qualified*. The file opened is the one specified by the name inside the quotation marks. If the name is not fully qualified, z/OS XL C/C++ does one of the following:

- If your system does not use RACF, z/OS XL C/C++ does not add a high-level qualifier to the name you specified.
- If you are running under TSO (batch or interactive), z/OS XL C/C++ appends the TSO user prefix to the front of the name. For example, the statement `fopen("a.b", "w");` opens a data set `tsopref.A.B`, where `tsopref` is the user prefix. You can set the user prefix by using the TSO PROFILE command with the PREFIX parameter.

**Note:** The TSO prefix is not added when running POSIX(ON).

- If you are running under MVS batch or IMS (batch or online), z/OS XL C/C++ appends the RACF user ID to the front of the name.

**Using a DDname:** You can specify names that begin with `dd:`, but z/OS XL C/C++ treats the `dd:` as part of the file name.

**z/OS UNIX Considerations:** Using the `fork()` library function from z/OS UNIX application programs causes the memory file to be copied into the child process. The memory file data in the child is identical to that of the parent at the time of the `fork()`. The memory file can be used in either the child or the parent, but the data is not visible in the other process.

### **fopen() and freopen() keywords**

Table 33 lists the keywords that are available on the `fopen()` and `freopen()` functions, tells you which ones are useful for memory file I/O, and lists the values that are valid for the applicable ones.

*Table 33. Keywords for the fopen() and freopen() functions for memory file I/O*

Keyword	Allowed?	Applicable?	Notes
<code>recfm=</code>	Yes	No	This parameter is ignored for memory file and hiperspace I/O. If you specify a RECFM, it must have correct syntax. Otherwise the <code>fopen()</code> call fails.
<code>lrecl=</code>	Yes	No	This parameter is ignored for memory file and hiperspace I/O. If you specify an LRECL, it must have correct syntax. Otherwise <code>fopen()</code> call fails.
<code>blksize=</code>	Yes	No	This parameter is ignored for memory file and hiperspace I/O. If you specify a BLKSIZE, it must have correct syntax. Otherwise <code>fopen()</code> call fails.
<code>acc=</code>	Yes	No	This parameter is ignored for memory file and hiperspace I/O. If you specify an ACC, it must have correct syntax. Otherwise <code>fopen()</code> fails.
<code>password=</code>	No	No	Ignored for memory files.
<code>space=</code>	Yes	No	This parameter is ignored for memory file and hiperspace I/O. If you specify a SPACE, it must have correct syntax. Otherwise, <code>fopen()</code> call fails.
<code>type=</code>	Yes	Yes	Valid values are memory and memory(hiperspace). See the parameter list below.
<code>asis</code>	Yes	Yes	Enables the use of mixed-case file names.

Table 33. Keywords for the `fopen()` and `freopen()` functions for memory file I/O (continued)

Keyword	Allowed?	Applicable?	Notes
<code>byterseek</code>	Yes	No	Ignored for memory files, as they use <code>byterseeking</code> by default.
<code>noseek</code>	Yes	No	This parameter is ignored for memory file and <code>hiperspace</code> I/O.
<code>OS</code>	No	No	This parameter is not valid for memory file and <code>hiperspace</code> I/O. If you specify <code>OS</code> , your <code>fopen()</code> call fails.

**recfm=**

`z/OS XL C/C++` parses your specification for these values. If they do not have the correct syntax, your function call fails. If they do, `z/OS XL C/C++` ignores their values and continues.

**lrecl= and blksize=**

`z/OS XL C/C++` parses your specification for these values. If they do not have the correct syntax, your function call fails. If they do, `z/OS XL C/C++` ignores their values and continues.

**acc=**

`z/OS XL C/C++` parses your specification for these values. If they do not have the correct syntax, your function call fails. If they do, `z/OS XL C/C++` ignores their values and continues.

**password=**

This parameter is not valid for memory file and `hiperspace` I/O. If you specify `PASSWORD`, your `fopen()` call fails.

**space=**

`z/OS XL C/C++` parses your specification for these values. If they do not have the correct syntax, your function call fails. If they do, `z/OS XL C/C++` ignores their values and continues.

**type=**

To create a memory file, you must specify `type=memory`. You cannot specify `type=record` or `type=blocked`; if you do, `fopen()` or `freopen()` fails. To create a `hiperspace` memory file, you must specify `type=memory(hiperspace)`.

**asis**

If you use this parameter, you can specify mixed-case filenames, such as `JaMeS dAtA` or `pErCy.FILE`. If you are running with `POSIX(ON)`, `asis` is the default.

**byterseek**

This parameter is ignored for memory file and `hiperspace` I/O.

**noseek**

This parameter is ignored for memory file and `hiperspace` I/O.

**OS**

This parameter is not allowed for memory file and `hiperspace` I/O. If you specify `OS`, your `fopen()` call fails.

Once a memory file has been created, it can be accessed by the module that created it as well as by any function or module that is subsequently invoked (including modules that are called using the `system()` library function), and by any modules in the current chain of `system()` calls, if you are running with `POSIX(OFF)`. If you are running with `POSIX(ON)`, the `system()` function is the `POSIX` one, not the `ANSI` one, and it does not propagate memory files to a child program. Once the

file has been created, you can open it with the same name, without specifying the `type=memory` parameter. You cannot specify `type=record` or `type=blocked` for a memory file.

This is how z/OS XL C/C++ searches for memory files:

1. `fopen("my.file", "w....,type=memory");` z/OS XL C/C++ checks the open files to see if a file with that name is already open. If not, it creates a memory file.
2. `fopen("my.file", "w.....");` z/OS XL C/C++ checks the open files to see if a file with that name is already open. If not, it then checks to see whether a memory file exists with that name. If so, it opens the memory file; if not, it creates a disk file.
3. `fopen("my.file", "a....,type=memory");` z/OS XL C/C++ checks the open files to see if a file with that name is already open. If not, it searches the existing memory files to see whether a memory file exists with that name. If so, z/OS XL C/C++ opens it; if not, it creates a new memory file.
4. `fopen("my.file", "a....");` z/OS XL C/C++ checks the open files to see if a file with that name is already open. If not, z/OS XL C/C++ searches existing files (both disk and memory) according to file mode, and opens the first file that has that name. If there is no such file, z/OS XL C/C++ creates a disk file.
5. `fopen("my.file", "r....,type=memory");` z/OS XL C/C++ searches the memory files to see if a file with that name exists. If one does, z/OS XL C/C++ opens it. Otherwise, the `fopen()` call fails.
6. `fopen("my.file", "r....");` z/OS XL C/C++ searches first through memory files. If it does not find the specified one, it then tries to open a disk file.

If you specify a memory file name that has an asterisk (\*) as the first character, a name is created for that file. (You can acquire this name by using `fldata()`.) For example, you can specify `fopen("*", "type=memory");`. Opening a memory file this way is faster than using the `tmpnam()` function.

**z/OS UNIX System Services Considerations:** If you have specified `POSIX(ON)`, `fopen("*file.data", "w,type=memory")` does not generate a name for the memory file. Instead, it opens a memory file called `*file.data`. To generate a memory file name when `POSIX(ON)` has been specified, you must use two slashes before the asterisk, shown as follows:

```
fopen("//*file.data", "w,type=memory")
```

You cannot have any blanks or periods in the member name of a memory file. Otherwise, all valid data set names are accepted for memory files. Note that if invalid disk file names are used for memory files, difficulties could occur when you try to port memory file applications to disk-file applications.

Memory files are always opened in fixed binary mode regardless of the open mode. There is no blank padding, and control characters such as the new line are written directly into the file (even if the `fopen()` specifies text mode).

## Opening hiperspace files

To create a memory file in hiperspace, specify `type=memory(hiperspace)` on the `fopen()` call that creates the file. If hiperspace is not available, you get a regular memory file. Under systems that do not support hiperspaces, as well as when you are running with `POSIX(ON)` and `TRAP(OFF)`, a specification of `type=memory(hiperspace)` is treated as `type=memory`. Use of `TRAP(OFF)` is not recommended.



You must decide whether a file is to be a hiperspace memory file before you create it. You cannot change a memory file to a hiperspace memory file by specifying `type=memory(hiperspace)` on a subsequent call to `fopen()` or `freopen()`. If the hiperspace to store the file cannot be created, the `fopen()` or `freopen()` call fails.

Once you have created a hiperspace memory file, you do not have to specify `type=memory(hiperspace)` on subsequent function calls that open the file.

If you open a hiperspace memory file for read at the same time that it is opened for write, you can attempt to read extensions made by the writer, even after the EOF flag has been set on by a previous read. If such a read succeeds, the EOF flag is set off until the new EOF is reached. If you have opened a file once for write and one or more times for read, a reader can now read past the original EOF.

## Simulating partitioned data sets

You can create memory files that are conceptually grouped as a partitioned data set (PDS). Grouping the files in this way offers the following advantages:

- You can remove all the members of a PDS by stating the data set name.
- You can rename the qualifiers of a PDS without renaming each member individually.

When you establish that a memory file has members, you can rename and remove all the members by specifying the file name and no members, just as with a PDS or PDSE. None of the members can be open for you to perform this action. Once a memory file is created with or without a member, another memory file with the same name (with or without a member) cannot be created as well. For example, if you open memory file `a.b` and write to it, z/OS XL C/C++ does not allow a memory file named `a.b(c)` until you close and remove `a.b`. Also, if you create a memory file named `a.b(mbr1)`, you cannot open a file named `a.b` until you close and remove `a.b(mbr1)`.

Sample program `CCNGMF1` (Figure 31 on page 207) demonstrates the removal of all the members of the data set `a.b`. After the call to `remove()`, neither `a.b(mbr1)` nor `a.b(mbr2)` exists.

---

```

/* this example shows how to remove members of a PDS */

#include <stdio.h>

int main(void)
{
    FILE * fp1, * fp2;
    fp1=fopen("a.b(mbr1)", "w, type=memory");
    fp2=fopen("a.b(mbr2)", "w, type=memory");
    fwrite("hello, world\n", 1, 13, fp1);
    fwrite("hello, world\n", 1, 13, fp2);
    fclose(fp1);
    fclose(fp2);
    remove("a.b");
    fp1=fopen("a.b(mbr1)", "r, type=memory");
    if (fp1 == NULL) {
        perror("fopen():");
        printf("fopen(\"a.b(mbr1)\") failed as expected: "
            "the file has been removed\n");
    }
    else {
        printf("fopen() should have failed\n");
    }
    return(0);
}

```

---

*Figure 31. Removing members of a PDS*

Sample program CCNGMF2 (Figure 32 on page 208) demonstrates the renaming of a PDS from a.b to c.d.

---

```

/* this example shows how to rename a PDS */

#include <stdio.h>

int main(void)
{
    FILE * fp1, * fp2;

    fp1=fopen("a.b(mbr1)", "w, type=memory");
    fp2=fopen("a.b(mbr2)", "w, type=memory");
    fclose(fp1);
    fclose(fp2);
    rename("a.b", "c.d");

/* after renaming, you cannot access members of PDS a.b */

    fp1=fopen("a.b(mbr1)", "r, type=memory");
    if (fp1 == NULL) {
        perror("fopen():");
        printf("fopen(\"a.b(mbr1)\") failed as expected: "
            "the file has been renamed\n");
    }
    else {
        printf("fopen() should have failed\n");
    }

    fp2=fopen("c.d(mbr2)", "r, type=memory");
    if (fp2 != NULL) {
        printf("fopen(\"c.c(mbr1)\") worked as expected: "
            "the file has been renamed\n");
    }
    else {
        perror("fopen():");
        printf("fopen() should have worked\n");
    }

    return(0);
}

```

---

*Figure 32. Renaming members of a PDS*

**Note:** If you are using simulated PDSs, you can change either the name of the PDS, *or* the member name. You cannot rename a.b(mbr1) to either c.d(mbr2) or c.d, but you can rename a.b(mbr1) to a.b(mbr2), and a.b to c.d.

Memory files that are open as a sequential data set cannot be opened again with a member name specified. Also, if a data set is already open with a member name, the sequential data set version with only the data set name cannot be opened. These operations result in fopen() returning NULL. For example, fopen() returns NULL in the second line of the following:

```

fp = fopen("a.b", "w, type=memory");
fp1 = fopen("a.b(m1)", "w, type=memory");

```

You cannot use the rename() or remove() functions on open files.

## Buffering

Regular memory files are not buffered. Any parameters passed to setvbuf() are ignored. Each character that you write is written directly to the memory file.

Hiperspace memory files are fully buffered. The size of the I/O buffer in your own address space is 4KB.

If you call setvbuf() for a hiperspace memory file:

- If the size value is greater than or equal to 4K, it will be set to 4K, and this buffer size will be used. Otherwise, the size value is ignored, and z/OS XL C/C++ will allocate a buffer.
- If a pointer to a buffer is passed, the buffer must be aligned on a 4K boundary. Otherwise, z/OS XL C/C++ will allocate a buffer.

---

## Reading from files

You can use the following library functions to read information from memory files; see *z/OS XL C/C++ Runtime Library Reference* for more information on these library functions.

- `fread()`
- `fread_unlocked()`
- `fgets()`
- `fgets_unlocked()`
- `gets()`
- `gets_unlocked()`
- `fgetc()`
- `fgetc_unlocked()`
- `getc()`
- `getc_unlocked()`
- `getchar()`
- `getchar_unlocked()`
- `scanf()`
- `scanf_unlocked()`
- `fscanf()`
- `fscanf_unlocked()`
- `vscanf()`
- `vscanf_unlocked()`
- `vfscanf()`
- `vfscanf_unlocked()`

The `gets()`, `getchar()`, `scanf()`, and `vscanf()` functions read from `stdin`, which can be redirected to a memory or hiperspace memory file.

You can open an existing file for read one or more times, even if it is already open for write. You cannot open a file for write if it is already open (for either read or write). If you want to update or truncate a file or append to a file that is already open for reading, you must first close all the other streams that refer to that file.

For memory files, a read operation directly after a write operation without an intervening call to `fflush()`, `fsetpos()`, `fseek()`, or `rewind()` fails. z/OS XL C/C++ treats the following as read operations:

- Calls to read functions that request 0 bytes
- Read requests that fail because of a system error
- Calls to the `ungetc()` function

You can set up a `SIGIOERR` handler to catch read or write system errors that happen when you are using hiperspace memory files. See Chapter 18, “Debugging I/O programs,” on page 223 for more information.

---

## Writing to files

You can use the following library functions to write to a file. See *z/OS XL C/C++ Runtime Library Reference* for more information on these library functions.

- `fwrite()`
- `fwrite_unlocked()`
- `printf()`
- `printf_unlocked()`
- `fprintf()`
- `fprintf_unlocked()`
- `vprintf()`
- `vprintf_unlocked()`
- `vfprintf()`
- `vfprintf_unlocked()`
- `puts()`
- `puts_unlocked()`
- `fputs()`
- `fputs_unlocked()`
- `fputc()`
- `fputc_unlocked()`
- `putc()`
- `putc_unlocked()`
- `putchar()`
- `putchar_unlocked()`

The `printf()`, `puts()`, `putchar()`, and `vprintf()` functions write to `stdout`, which can be redirected to a memory or hiperspace memory file.

In hiperspace memory files, each library function causes your data to be moved into the buffer in your address space. The buffer is written to hiperspace each time it is filled, or each time you call the `fflush()` library function.

`z/OS XL C/C++` counts a call to a write function writing 0 bytes or a write request that fails because of a system error as a write operation. For regular memory files, the only possible system error that can occur is an error in acquiring storage.

---

## Flushing records

`fflush()` does not move data from an internal buffer to a memory file, because the data is written to the memory file as it is generated. However, `fflush()` does make the data visible to readers who have a regular or hiperspace memory file open for reading while a user has it open for writing.

Hiperspace memory files are fully buffered. The `fflush()` function writes data from the internal buffer to the hiperspace.

Any repositioning operation writes data to the hiperspace.

The `fclose()` function also invokes `fflush()` when it detects an incomplete buffer for a file that is open for writing or appending.

## ungetc() considerations

`ungetc()` pushes characters back onto the input stream for memory files. `ungetc()` handles only single-byte characters. You can use it to push back as many as four characters onto the `ungetc()` buffer. For every character pushed back with `ungetc()`, `fflush()` backs up the file position by one character and clears all the pushed-back characters from the stream. Backing up the file position may end up going across a record boundary.

If you want `fflush()` to ignore `ungetc()` characters, you can set the `_EDC_COMPAT` environment variable. See Chapter 32, “Using environment variables,” on page 467 for more information.

---

## Repositioning within files

You can use the following library functions to help you position within a memory or hiperspace memory file. See *z/OS XL C/C++ Runtime Library Reference* for more information on these library functions.

- `fgetpos()`
- `fgetpos_unlocked()`
- `fsetpos()`
- `fsetpos_unlocked()`
- `fseek()`
- `fseek_unlocked()`
- `ftell()`
- `ftell_unlocked()`
- `rewind()`
- `rewind_unlocked()`

Using `fseek()` to seek past the end of a memory file extends the file using null characters. This may cause z/OS XL C/C++ to attempt to allocate more storage than is available as it tries to extend the memory file.

When you use the `fseek()` function with memory files, it supports byte offsets from `SEEK_SET`, `SEEK_CUR`, and `SEEK_END`.

All file positions from `ftell()` are relative byte offsets from the beginning of the file. `fseek()` supports these values as offsets from `SEEK_SET`.

`fgetpos()`, `fseek()` with an offset of `SEEK_CUR`, and `ftell()` handle `ungetc()` characters unless you have set the `_EDC_COMPAT` environment variable, in which case `fgetpos()` and `fseek()` do not. See Chapter 32, “Using environment variables,” on page 467 for more information about `_EDC_COMPAT`. If in handling these characters, if the current position goes beyond the start of the file, `fgetpos()` returns the EOF value, and `ftell()` returns -1.

`fgetpos()` values generated by code from previous releases of the z/OS XL C/C++ compiler are not supported by `fsetpos()`.

---

## Closing files

Use the `fclose()` library function to close a regular or hiperspace memory file. See *z/OS XL C/C++ Runtime Library Reference* for more information on this library function. *z/OS XL C/C++* automatically closes memory files at the termination of the C root main environment.

## Performance tips

You should use hiperspace memory files instead of regular memory files when they will be large (1MB or greater).

Regular memory files perform more efficiently if large amounts of data (10K or more) are written in one request (that is, if you pass 10K or more of data to the `fwrite()` function). You should use `fopen("*", "type=memory")` both to generate a name for a memory file and to open the file instead of calling `fopen()` with a name returned by `tmpnam()`. You can acquire the file's generated name by using `fldata()`.

---

## Removing memory files

The memory file remains accessible until the file is removed by the `remove()` or `clrmemf()` library functions or until the root program has terminated. You cannot remove an open memory file, except when you use `clrmemf()`. See *z/OS XL C/C++ Runtime Library Reference* for more information on these library functions.

---

## fldata() behavior

The `fldata()` function is used to retrieve information about an open stream; it has the following format:

```
int fldata(FILE *file, char *filename, fldata_t *info);
```

The name of the file is returned in *filename* and other information is returned in the `fldata_t` structure, shown in Figure 33 on page 213. Values specific to this category of I/O are shown in the comment beside the structure element. Additional notes pertaining to this category of I/O follow. For more information on the `fldata()` function, refer to *z/OS XL C/C++ Runtime Library Reference*.

---

```

struct __fileData {
    unsigned int  __recfmF   : 1, /* always on           */
                 __recfmV   : 1, /* always off          */
                 __recfmU   : 1, /* always off          */
                 __recfmS   : 1, /* always off          */
                 __recfmBlk : 1, /* always off          */
                 __recfmASA : 1, /* always off          */
                 __recfmM   : 1, /* always off          */
                 __dsorgPO  : 1, /* N/A -- always off  */
                 __dsorgPDSmem : 1, /* N/A -- always off  */
                 __dsorgPDSdir : 1, /* N/A -- always off  */
                 __dsorgPS   : 1, /* N/A -- always off  */
                 __dsorgConcat : 1, /* N/A -- always off  */
                 __dsorgMem  : 1, /*                    */
                 __dsorgHiper : 1, /*                    */
                 __dsorgTemp : 1, /* N/A -- always off  */
                 __dsorgVSAM : 1, /* N/A -- always off  */
                 __dsorgHFS  : 1, /* N/A -- always off  */
                 __openmode  : 2, /* __BINARY            */
                 __modeflag  : 4, /* combination of:    */
                                /* __READ              */
                                /* __WRITE             */
                                /* __APPEND            */
                                /* __UPDATE           */
                 __dsorgPDSE : 1, /* N/A -- always off  */
                 __reserve2  : 8; /*                    */
    __device_t    __device; /* one of:            */
                                /* __MEMORY            */
                                /* __HIPERSPACE        */
    unsigned long __blksize, /*                    */
                 __maxreclen; /*                    */
    unsigned short __vsamtype; /* N/A                */
    unsigned long  __vsamkeylen; /* N/A                */
    unsigned long  __vsamRKP; /* N/A                */
    char *         __dsname; /*                    */
    unsigned int   __reserve4; /*                    */
};
typedef struct __fileData fldata_t;

```

---

Figure 33. *fldata()* structure

**Notes:**

1. The *filename* is the fully qualified version of the filename specified on the `fopen()` or `freopen()` function call. There are no quotation marks. However, if the filename specified on the `fopen()` or `freopen()` function call begins with an `*`, a unique filename is generated in the format `((n))`, where *n* is an integer.
2. The `__dsorgMem` bit will be set on only for regular memory files.
3. The `__dsorgHiper` bit will be set on only for hiperspace memory files.
4. The `__dsname` is identical to the *filename* value.

---

## Example program

The following examples show the use of a memory file. Program CCNGMF3 (Figure 34 on page 214) creates a memory file, calls program CCNGMF4 (Figure 35 on page 214), and redirects the output of the called program to the memory file. When control returns to the first program, the program reads and prints the string in the memory file.

For more information on the `system()` library function, see *z/OS XL C/C++ Runtime Library Reference*.



---

```

/* this example demonstrates the use of a memory file */
/* part 1 of 2-other file is CCNGMF4 */
#include <stdio.h>
#include <string.h>
#include <stdlib.h>

int main(void)
{
    FILE *fp;
    char buffer[20];
    char *rc;

    /* Open the memory file to create it */
    if ((fp = fopen("PROG.DAT","wb+,type=memory")) != NULL)
    {
        /* Close the memory file so that it can be used as stdout */
        fclose(fp);

        /* Call CCNGMF4 and redirect its output to memory file */
        /* CCNGMF4 must be an executable MODULE */
        system("CCNGMF4 >PROG.DAT");
    }

    /* Now print the string contained in the file */

    fp = fopen("PROG.DAT","rb");
    rc = fgets(buffer,sizeof(buffer),fp);
    if (rc == NULL)
    {
        perror(" Error reading from file ");
        exit(99);
    }
    printf("%s", buffer);
}

return(0);
}

```

---

*Figure 34. Memory file example, part 1*

Figure 35 redirects the output of the called program to the memory file.

---

```

/* this example demonstrates the use of a memory file */
/* part 2 of 2-other file is CCNGMF3 */

#include <stdio.h>
#include <stdlib.h>

int main(void)
{
    char item1[] = "Hello World\n";
    int rc;

    /* Write the data to the stdout which, at this point, has been
    redirected to the memory file */
    rc = fputs(item1,stdout);
    if (rc == EOF) {
        perror("Error putting to file ");
        exit(99);
    }

    return(0);
}

```

---

*Figure 35. Memory file example, part 2*

---

## Chapter 15. Performing CICS Transaction Server I/O operations

**Restriction:** This chapter does not apply to AMODE 64.

z/OS XL C/C++ under CICS Transaction Server for z/OS (CICS TS) supports only three kinds of I/O:

### CICS I/O

z/OS XL C/C++ applications can access the CICS I/O commands through the CICS command level interface.

### Files

Memory files are the only type of file that z/OS XL C/C++ supports under CICS. Hipspace files are not supported. VSAM files can be accessed through the CICS command level interface.

### CICS data queues

Under CICS, z/OS XL C/C++ implements the standard output (stdout) and standard error (stderr) streams as CICS transient data queues. These data queues must be defined in the CICS Destination Control table (DCT) by the CICS system administrator before the CICS cold start. Output from all users' transactions that use stdout (or stderr) is written to the queue in the order of occurrence.

To help differentiate the output, place a user's terminal name, the CICS transaction identifier, and the time at the beginning of each line printed to the queue. The queues are as follows:

Stream	Queue
stdout	CESO
stderr	CESE
stdin	Not supported

To access any other queues, you must use the command level interface.

**Note:** If you are using the C++ I/O stream classes, the standard stream cout maps to stdout, which maps to CES0. The standard stream cerr and clog both map to stderr, which maps to CESE. The standard stream cin is not supported under CICS.

For more general information about C++ I/O streaming, see Chapter 4, "Using the Standard C++ Library I/O Stream Classes," on page 23. For more detailed information, see *Standard C++ Library Reference*, which discusses the Standard C++ I/O stream classes

For information about using z/OS XL C/C++ and z/OS XL C/C++ under CICS TS, see Chapter 52, "Using the CICS Transaction Server (CICS TS)," on page 879. For information on using wide characters in the CICS TS environment, see Chapter 8, "z/OS XL C Support for the double-byte character set," on page 53.



---

## Chapter 16. Language Environment Message file operations

This chapter describes input and output with the z/OS Language Environment message file. This file is write-only. That is, it is nonreadable and nonseekable.

**Restriction:** This chapter does not apply to AMODE 64. There is no MSGFILE runtime option in AMODE 64. In AMODE 64, the `stderr` stream does not get directed to the Language Environment message file. Anything that would normally go to the Language Environment message file is now directed to the C `stderr` stream, including when `stderr` is directed to `stdout`. For more information on AMODE 64 see Chapter 23, “z/OS 64-bit environment,” on page 325.

The default open mode for the z/OS Language Environment message file is text. Binary and record I/O modes are not supported.

This chapter also describes C I/O streams as they can be used within C++ programs. If you want to use the C++ I/O stream classes instead, see Chapter 4, “Using the Standard C++ Library I/O Stream Classes,” on page 23 for general information. For more detailed information, see *Standard C++ Library Reference*, which discusses the Standard C++ I/O stream classes.

The standard stream `stderr` defaults to using the z/OS Language Environment message file. `stderr` will be directed to file descriptor 2, which is typically your terminal if you are running under one of the z/OS UNIX shells. There are some exceptions, however:

- If the application has allocated the `ddname` in the `MSGFILE(ddname)` runtime parameter, your output will go there. The default is `MSGFILE(SYSOUT)`.
- If the application has issued one of the POSIX `exec()` functions, or it is running in an address space created by the POSIX `fork()` function and the application has not dynamically allocated a `ddname` for `MSGFILE`, then the default is to use file descriptor 2, if one exists. If it doesn't, then the default is to create a message file in the user's current working directory. The message file will have the name that is specified on the message file runtime option, the default being `SYSOUT`.

---

### Opening files

The default is for `stderr` to go to the message file automatically. The message file is available only as `stderr`; you cannot use the `fopen()` or `freopen()` library function to open it.

- `freopen()` with the null string (“”) as filename string will fail.
- Record format (RECFM) is always treated as undefined (U). Logical record length (LRECL) is always treated as 255 (the maximum length defined by z/OS Language Environment message file system write interface).

---

### Reading from files

The z/OS Language Environment message file is nonreadable.

---

## Writing to files

- Data written to the z/OS Language Environment message file is always appended to the end of the file.
- When the data written is longer than 255 bytes, it is written to the z/OS Language Environment message file 255 bytes at a time, with the last write possibly less than 255 bytes. No truncation will occur.
- When the output data is shorter than the actual LRECL of the z/OS Language Environment message file, it is padded with blank characters by the z/OS Language Environment system write interface.
- When the output data is longer than the actual LRECL of the z/OS Language Environment message file, it is split into multiple records by the z/OS Language Environment system write interface. The z/OS Language Environment system write interface splits the output data at the last blank before the LRECL-th byte, and begins writing the next record with the first non-blank character. Note that if there are no blanks in the first LRECL bytes (DBCS for instance), the z/OS Language Environment system write interface splits the output data at the LRECL-th byte. It also closes off any DBCS string on the first record with a X'0F' character, and begins the DBCS string on the next record with a X'0E' character.
- The hex characters X'0E' and X'0F' have special meaning to the z/OS Language Environment system write interface. The z/OS Language Environment system write interface removes adjacent pairs of these characters (normalization).
- You can set up a SIGIOERR handler to catch system write errors. See Chapter 18, "Debugging I/O programs," on page 223 for more information.

---

## Flushing buffers

The `fflush()` function has no effect on the z/OS Language Environment message file.

---

## Repositioning within files

The `ftell()`, `fgetpos()`, `fseek()`, and `fsetpos()` functions are not allowed, because z/OS Language Environment message file is a nonseekable file. The `frewind()` function only resets error flags.

You cannot call `fseek()` on `stderr` when it is mapped to `MSGFILE` (the default routing of `stderr`).

---

## Closing files

Do not use the `fclose()` library function to close the z/OS Language Environment message file. z/OS XL C/C++ automatically closes files on normal program termination and attempts to do so under abnormal program termination or `abend`.

---

## Chapter 17. CELQPIPI MSGRTN file operations

**Restriction:** This chapter only applies to AMODE 64 when using preinitialization services.

If the CELQPIPI MSGRTN service routine is specified and the standard stream `stderr` has not been redirected, it defaults to using the CELQPIPI MSGRTN. The remainder of this chapter describes the behavior of the standard stream `stderr` when used in the application.

The CELQPIPI MSGRTN file is write-only. That is, the file is nonreadable and nonseekable. The mode for this file is text append. Binary and record I/O modes are not supported.

---

### Opening files

The default behavior is that standard stream `stderr` will go to the CELQPIPI MSGRTN. You cannot use the `fopen()` or `freopen()` library functions to open or reopen the CELQPIPI MSGRTN.

- Using `fopen()` to assign a stream to `stderr` directs `stderr` away from the CELQPIPI MSGRTN.
- A call to `freopen()` with the null string ("") as the filename string in an attempt to reopen the CELQPIPI MSGRTN using a different mode will fail.
- Record format (RECFM) is always treated as undefined (U). Logical record length (LRECL) is always treated as 255, which is the maximum length defined by the write interface of the CELQPIPI MSGRTN file system.

---

### Reading from files

The CELQPIPI MSGRTN file is nonreadable.

---

### Writing to files

- Data written to the CELQPIPI MSGRTN file is always appended to the end of the file.
- When the data written is longer than 255 bytes, it is written to the CELQPIPI MSGRTN file 255 bytes at a time, with the last write possibly less than 255 bytes. No truncation will occur.
- When the output data is shorter than the actual LRECL of the CELQPIPI MSGRTN file, it is padded with blank characters by the z/OS Language Environment system write interface.

---

### Flushing buffers

The `fflush()` function has no effect on the CELQPIPI MSGRTN file.

---

### Repositioning within files

The `ftell()`, `fgetpos()`, `fseek()`, and `fsetpos()` functions are not allowed, because CELQPIPI MSGRTN file is nonseekable. The `rewind()` function only resets error flags.

---

## Closing files

Do not use the `fclose()` library function to close the CELQPIPI MSGRTN file. z/OS XL C/C++ automatically closes files on normal program termination and attempts to do so under abnormal program termination or `abend`.

---

## fldata() behavior

The `fldata()` function is used to retrieve information about an open stream. The name of the file is returned in `filename` and other information is returned in the `fldata_t` structure, shown in Figure 36. Values specific to this category of I/O are shown in the comment beside the structure element. For more information about the `fldata()` function, see *z/OS XL C/C++ Runtime Library Reference*.

---

```
struct __fileData {
    unsigned int    __recfmF    : 1,          /*          */
                  __recfmV    : 1,          /*          */
                  __recfmU    : 1,          /* always on */
                  __recfmS    : 1,          /*          */
                  __recfmBlk  : 1,          /*          */
                  __recfmASA  : 1,          /*          */
                  __recfmM    : 1,          /*          */
                  __dsorgPO   : 1,          /*          */
                  __dsorgPDSmem : 1,        /*          */
                  __dsorgPDSdir : 1,        /*          */
                  __dsorgPS   : 1,          /* always on */
                  __dsorgConcat : 1,        /*          */
                  __dsorgMem  : 1,          /*          */
                  __dsorgHiper : 1,          /*          */
                  __dsorgTemp  : 1,          /*          */
                  __dsorgVSAM : 1,          /*          */
                  __dsorgHFS  : 1,          /*          */
                  __openmode  : 2,          /* __TEXT   */
                  __modeflag  : 4,          /* __APPEND */
                  __dsorgPDSE : 1,          /*          */
                  __vsamRLS   : 3,          /*          */
                  __vsamEA    : 1,          /*          */
                  __reserve2  : 4;          /*          */
    __device_t     __device;               /* __MSGRTN */
    unsigned long  __blksize,               /* 255      */
                  __maxreclen;            /* 255      */
    union {
        struct {
            unsigned short __vsam_type;    /*          */
            unsigned long  __vsam_keylen;  /*          */
            unsigned long  __vsam_RKP;     /*          */
        } __vsam;
        struct {
            unsigned char  __disk_access_method; /*          */
            unsigned char  __disk_noseek_to_seek; /*          */
            long           __disk_reserve[2];    /*          */
        } __disk;
    } __device_specific;
    char *         __dsname;                /*          */
    unsigned int  __reserve4;               /*          */
};
typedef struct __fileData fldata_t;
```

---

Figure 36. `fldata()` structure

---

## fldata() example

Figure 37 example shows the retrieval of the file name in *filename* from the open stream pointed to by *stderr* that maps to the CELQPIPI MSGRTN file.

---

```
#include <stdio.h>
int main(void) {
    FILE *stream;
    char filename[100];
    fldata_t fileinfo;
    int rc;
    stream = stderr;
    rc = fldata(stream, filename, &fileinfo);
    if (rc != 0)
        printf("fldata failed\n");
    else
        printf("filename is %s\n",filename);
}
```

---

*Figure 37. fldata() example*

The program in Figure 37 produces the following output:

```
filename is ((MSGRTN))
```

The example in Figure 38 shows the use of the CELQPIPI MSGRTN file as the default *stderr*.

---

```
#include <stdio.h>
#include <errno.h>
int main(void) {
    FILE *stream;

    stream = stderr;

    fprintf(stream, "fprintf: Output redirects to the CELQPIPI MSGRTN file.\n");

    errno = ETIME;
    perror("perror: Output redirects to the CELQPIPI MSGRTN file.");
}
```

---

*Figure 38. CELQPIPI MSGRTN example*





---

## Chapter 18. Debugging I/O programs

This chapter will help you locate and diagnose problems in programs that use input and output. It discusses several diagnostic methods specific to I/O.

Diagnostic methods for I/O errors include:

- Using return codes from I/O functions
- Using errno values and the associated perror() message
- Using the \_\_amrc structure
- Using the \_\_amrc2 structure

The information provided with the return code of I/O functions and with the perror() message associated with errno values may help you locate the source of errors and the reason for program failure. Because return codes and errno values do not exist for every possible system I/O failure, return codes and errno values are not useful for diagnosing all I/O errors. This chapter discusses the use of the \_\_amrc structure and the \_\_amrc2 structure. For information on return codes from I/O functions see *z/OS XL C/C++ Runtime Library Reference*. For information on errno values and the associated perror() message see *z/OS Language Environment Debugging Guide*.

---

### Using the \_\_amrc structure

\_\_amrc is a structure defined in `stdio.h` (when the compile-time option `LANGLVL(EXTENDED)` or `LANGLVL(LIBEXT)` is in effect) to help you determine errors resulting from an I/O operation. This structure is changed during system I/O and some C specific error situations. When looking at \_\_amrc, be sure to copy the structure into a temporary structure of \_\_amrc type since any I/O function calls will change the value of \_\_amrc. Figure 39 shows the \_\_amrc structure as it appears in `stdio.h`.

**Note:** \_\_amrc is not used to record I/O errors in UNIX file system files.

```
#if __TARGET_LIB__ >= __EDC_LE
    typedef struct __amrc_type {
#else
    typedef struct {
#endif
        /* The error or warning value from
        * an I/O operation is in __error,
        * __abend, __feedback or __alloc.
        * Look at the value in __last_op
        * to determine how to interpret
        * the __code union. */
        union {
            int __error; /* error from OPEN/CLOSE,
            * GENCB/MODCB/TESTCB/SHOWCB */
            struct {
                unsigned short __syscode, /* system abend code */
                __rc; /* return code */
            } __abend;
        };
    };
```

*\_\_amrc structure (Part 1 of 2)*

Figure 39. \_\_amrc structure

```

    struct {
        unsigned char __fdbk_fill,
                    __rc, /* reg 15 */
                    __ftncd, /* function code */
                    __fdbk; /* feedback code */
    } __feedback; 4
    struct {
        unsigned short __svc99_info,
                    __svc99_error;
    } __alloc; 5
} __code;
unsigned int __RBA; 6
/* RBA value returned by VSAM after *
 * an ESDS or KSDS record is written *
 * out; for RRDS it is a calculated *
 * value from the record number. *
 * It may be used in a subsequent *
 * call to flocate. */
unsigned int __last_op; 7
/* #defined below */
struct {
    unsigned int __len_fill; /* __len + 4 */
    unsigned int __len; /* length of msg in __str */
    char __str[120]; /* the actual data */
    unsigned int __parmr0; /* parameter save area (R0) */
    unsigned int __parmr1; /* parameter save area (R1) */
    unsigned int __fill2[2]; /* non-printable bytes */
    char __str2[64]; /* the actual data */
} __msg; 8
/* error message */

#if __EDC_TARGET >= 0x22080000
    unsigned char __rplfdbwd[4]; 9 /* rpl feedback word */
#endif
/* __EDC_TARGET >= 0x22080000 */
#if __EDC_TARGET >= 0x41080000
#ifdef __LP64
    unsigned long __XRBA; /* 8 byte RBA */
#elif defined(__LL)
    unsigned long long __XRBA; /* 8 byte RBA */
#else
    unsigned int __XRBA1; /* high half of 8 byte RBA */
    unsigned int __XRBA2; /* low half of 8 byte RBA */
#endif
/* QSAM to BSAM switch reason */
    unsigned char __amrc_noseek_to_seek; 11
/* padding to make amrc 256 bytes */
    char __amrc_pad[23];
#endif
} __amrc_type;

__amrc structure (Part 2 of 2)

```

### **1** union { ... } \_\_code

The error or warning value from an I/O operation is in either `__error`, `__abend`, `__feedback`, or `__alloc`. You must look at `__last_op` to determine how to interpret the `__code` union.

### **2** \_\_error

`__error` contains the return code from the system macro or utility. Refer to Table 34 on page 227 for further information.

### **3** \_\_abend

This struct contains the abend code when `errno` is set to indicate a

recoverable I/O abend. `__syscode` is the system abend code and `__rc` is the return code. For more information on the abend codes, see the System Codes manual as listed in *z/OS V2R2 Information Roadmap*. The macros `__abendcode()` and `__rsncode()` may be set to the abend code and reason code of a TSO CLIST or command when invoked with `system()`.

**4** `__feedback`

This struct is used for VSAM only. The `__rc` stores the VSAM register 15, `__fdbk` stores the VSAM error code or reason code, and `__RBA` stores the RBA after some operations.

**5** `__alloc`

This struct contains errors during `fopen()` or `freopen()` calls when defining files to the system using SVC 99. See the Systems Macros manual, as listed in *z/OS V2R2 Information Roadmap*, for more information on these fields as set by SVC 99.

**6** `__RBA`

This is the RBA value returned by VSAM after an ESDS or KSDS record is written out. For a RRDS, it is the calculated value from the record number. It may be used in subsequent calls to `flocate()`. The `__amrc.__RBA` field is defined as an unsigned int, and therefore will only contain a 4-byte RBA value. This field will be set to -1 when the RBA is beyond 4GB in an extended addressable VSAM data set. In this case, the `__XRBA` field should be used.

**7** `__last_op`

Contains a value that indicates the last I/O operation being performed by z/OS XL C/C++ at the time the error occurred. These values are shown in Table 34 on page 227.

**8** `__msg`

This may contain the system error messages from read or write operations emitted from the BSAM SYNADAF macro instruction. This field will not always be filled. If you print this field using the `%s` format, you should print the string starting at the sixth position because of possible null characters found in the first 6 characters. Special messages for PDSEs are contained in the positions 136 through 184. See the Data Administration manual as listed in *z/OS V2R2 Information Roadmap* for more information. This field is used by the SIGIOERR handler.

**9** `__rplfdbwd`

Contains feedback information related to a VSAM RLS failure. This is the feedback code from the IFGRPL control block.

**10** `__XRBA`

This is the 8 byte relative byte address returned by VSAM after an ESDS or KSDS record is written out. For an RRDS, it is the calculated value from the record number. It may be used in subsequent calls to `flocate()`.

**11** `__amrc_noseek_to_seek`

Contains the reason for the switch from QSAM (noseek) to BSAM with NOTE and POINT macros requested (seek) by the XL C/C++ Runtime Library. This field is set when system-level I/O macro processing triggers an ABEND condition. The macro name values (defined in `stdio.h`) for this field are as follows:

Macro	Definition
<code>__AM_BSAM_NOSWITCH</code>	No switch was made.

Macro	Definition
__AM_BSAM_UPDATE	Data set is open for update
__AM_BSAM_BSAMWRITE	Data set is already open for write (or update) in the same C process
__AM_BSAM_FBS_APPEND	Data set is recfm=FBS and open for append
__AM_BSAM_LRECLX	Data set is recfm=LRECLX (used for VBS data sets where records span the largest blocksize allowed on the device)
__AM_BSAM_PARTITIONED_DIRECTORY	Data set is the directory for a regular or extended partitioned data set
__AM_BSAM_PARTITIONED_INDIRECT	Data set is a member of a partitioned data set, and the member name was not specified at allocation

Sample program CCNGDI1 (Figure 40) demonstrates how to print the `__amrc` structure after an error has occurred to get information that may help you to diagnose an I/O error. The program writes to a file until it is full. When the file is full, the program fails. Following the I/O failure, the program makes a copy of the `__amrc` structure, and prints the number of successful writes to the file, the `errno`, the `__last_op` code, the `abend` system code and the return code.

```

/* this example demonstrates how to print the __amrc structure */
#include <stdio.h>
#include <errno.h>
#include <stdlib.h>
#include <string.h>

int main(void) {
    FILE *fp;
    __amrc_type save_amrc;
    char buffer[80];
    int i = 0;

    /* open an MVS binary file */

    fp = fopen("testfull.file","wb, recfm=F, lrecl=80");
    if (fp == NULL) exit(99);

    memset(buffer, 'A', 80);

    /* write to MVS file until it runs out of extents */

    while (fwrite(buffer, 1, 80, fp) == 80)
        ++i;

    save_amrc = *__amrc; /* need copy of __amrc structure */

    printf("number of successful fwrites of 80 bytes = %d\n", i);

```

*Example of printing the `__amrc` structure (Part 1 of 2)*

*Figure 40. Example of printing the `__amrc` structure*

```

printf("last fwrite errno=%d lastop=%d syscode=%X rc=%d\n",
      errno,
      save_amrc.__last_op,
      save_amrc.__code.__abend.__syscode,
      save_amrc.__code.__abend.__rc);

return 0;
}

```

Example of printing the `__amrc` structure (Part 2 of 2)

---

## Using the `__amrc2` structure

The `__amrc2` structure is an extension of `__amrc`. Only 2 fields are defined for `__amrc2`. Like the `__amrc` structure, `__amrc2` is changed during system I/O and some C specific error situations. Figure 41 shows the `__amrc2` structure as it appears in `stdio.h`.

**Note:** See “Using the SIGIOERR signal” on page 231 for information on restrictions that exist when comparing file pointers if you are using the `__amrc2` structure.

---

```

struct {
    int      __error2;      1      /*
    FILE     *__fileptr;   2      /*
    int      __reserved[6];
}

```

---

Figure 41. `__amrc2` structure

- 1** This field is a secondary error code that is used to store the reason code from specific macros. The `__last_op` codes that can be returned to `__amrc2` are `__BSAM_STOW`, `__BSAM_BLDL`, `__IO_LOCATE`, `__IO_RENAME`, `__IO_CATALOG` and `__IO_UNCATALOG`. For information on the macros associated with these codes, see Table 34. For more information about the macros, see *z/OS DFSMSdfp Diagnosis*.
- 2** This field, `__fileptr`, of the `__amrc2` structure is used by the signal SIGIOERR to pass back a FILE pointer that can then be passed to `fldata()` to get the name of the file causing the error. The `__amrc2__fileptr` will be NULL if a SIGIOERR is raised before the file has been successfully opened.

---

## Using `__last_op` codes

The `__last_op` field is the most important of the `__amrc` fields. It defines the last I/O operation z/OS XL C/C++ was performing at the time of the I/O error. You should note that the structure is neither cleared nor set by non-I/O operations so querying this field outside of a SIGIOERR handler should only be done immediately after I/O operations. Table 34 lists `__last_op` codes you may receive and where to look for further information.

Table 34. `__last_op` codes and diagnosis information

Code	More Information
<code>__BSAM_BLDL</code>	Sets <code>__error</code> with return code from OS BLDL macro.
<code>__BSAM_CLOSE</code>	Sets <code>__error</code> with return code from OS CLOSE macro.

Table 34. `__last_op` codes and diagnosis information (continued)

Code	More Information
<code>__BSAM_CLOSE_T</code>	Sets <code>__error</code> with return code from OS CLOSE TYPE=T.
<code>__BSAM_NOTE</code>	NOTE returned 0 unexpectedly, no return code.
<code>__BSAM_OPEN</code>	Sets <code>__error</code> with return code from OS OPEN macro.
<code>__BSAM_POINT</code>	This will not appear as an error lastop.
<code>__BSAM_READ</code>	No return code (either <code>__abend</code> (errno == 92) or <code>__msg</code> (errno == 66) filled in).
<code>__BSAM_STOW</code>	Sets <code>__error</code> with return code from OS STOW macro.
<code>__BSAM_WRITE</code>	No return code (either <code>__abend</code> (errno == 92) or <code>__msg</code> (errno == 65) filled in).
<code>__C_CANNOT_EXTEND</code>	This occurs when an attempt is made to extend a file that allows writing, but cannot be extended. Typically, this is a member of a partitioned data set being opened for update.
<code>__C_DBCS_SI_TRUNCATE</code>	This occurs only when there was not enough room to start a DBCS string and data was written anyway, with an SI to end it. Cannot happen if <code>MB_CUR_MAX</code> is 1.
<code>__C_DBCS_SO_TRUNCATE</code>	This occurs when there is not enough room in a record to start any DBCS string or else when a redundant SO is written to the file before an SI. Cannot happen if <code>MB_CUR_MAX</code> is 1.
<code>__C_DBCS_TRUNCATE</code>	This occurs when writing DBCS data to a text file and there is no room left in a physical record for anymore double byte characters. A new-line is not acceptable at this point. Truncation will continue to occur until an SI is written or the file position is moved. Cannot happen if <code>MB_CUR_MAX</code> is 1.
<code>__C_DBCS_UNEVEN</code>	This occurs when an SI is written before the last double byte character is completed, thereby forcing z/OS XL C/C++ to fill in the last byte of the DBCS string with a padding byte 'X'FE'. Cannot happen if <code>MB_CUR_MAX</code> is 1.
<code>__C_FCBCHECK</code>	Set when z/OS XL C/C++ FCB is corrupted. This is due to a pointer corruption somewhere. File cannot be used after this.
<code>__CICS_WRITEQ_TD</code>	Sets <code>__error</code> with error code from EXEC CICS WRITEQ TD.
<code>__C_TRUNCATE</code>	Set when z/OS XL C/C++ truncates output data. Usually this is data written to a text file with no newline such that the record fills up to capacity and subsequent characters cannot be written. For a record I/O file this refers to an <code>fwrite()</code> writing more data than the record can hold. Truncation is always of rightmost data. There is no return code.
<code>__HSP_CREATE</code>	Indicates last op was a DSPSERV CREATE to create a hiperspace for a hiperspace memory file. If CREATE fails, stores abend code in <code>__amrc.__code.__abend.__syscode</code> , reason code in <code>__amrc.__code.__abend.__rc</code> .
<code>__HSP_DELETE</code>	Indicates last op was a DSPSERV DELETE to delete a hiperspace for a hiperspace memory file during termination. If DELETE fails, stores abend code in <code>__amrc.__code.__abend.__syscode</code> , reason code in <code>__amrc.__code.__abend.__rc</code> .
<code>__HSP_EXTEND</code>	Indicates last op was a HSPSERV EXTEND during a write to a hiperspace. If EXTEND fails, stores abend code in <code>__amrc.__code.__abend.__syscode</code> , reason code in <code>__amrc.__code.__abend.__rc</code> .

Table 34. *\_\_last\_op codes and diagnosis information (continued)*

Code	More Information
<code>__HSP_READ</code>	Indicates last op was a HSPSERV READ from a hiperspace. If READ fails, stores abend code in <code>__amrc. __code. __abend. __syscode</code> , reason code in <code>__amrc. __code. __abend. __rc</code> .
<code>__HSP_WRITE</code>	Indicates last op was a HSPSERV WRITE to a hiperspace. If WRITE fails, stores abend code in <code>__amrc. __code. __abend. __syscode</code> , reason code in <code>__amrc. __code. __abend. __rc</code> .
<code>__IO_CATALOG</code>	Sets <code>__error</code> with return code from I/O CAMLST CAT. The associated macro is CATALOG.
<code>__IO_DEVTYPE</code>	Sets <code>__error</code> with return code from I/O DEVTYPE macro.
<code>__IO_INIT</code>	Will never be seen by SIGIOERR exit value given at initialization.
<code>__IO_LOCATE</code>	Sets <code>__error</code> with return code from I/O CAMLST LOCATE.
<code>__IO_OBTAIN</code>	Sets <code>__error</code> with return code from I/O CAMLST OBTAIN.
<code>__IO_RDJFCB</code>	Sets <code>__error</code> with return code from I/O RDJFCB macro.
<code>__IO_RENAME</code>	Sets <code>__error</code> with return code from I/O CAMLST RENAME.
<code>__IO_TRKCALC</code>	Sets <code>__error</code> with return code from I/O TRKCALC macro.
<code>__IO_UNCATALOG</code>	Sets <code>__error</code> with return code from I/O CAMLST UNCAT. The associated macro is CATALOG.
<code>__LFS_CLOSE</code>	Sets <code>__error</code> with reason code from UNIX file system services. Reason code from UNIX file system services must be broken up. The low order 2 bytes can be looked up in <i>z/OS UNIX System Services Programming: Assembler Callable Services Reference</i> .
<code>__LFS_FSTAT</code>	Sets <code>__error</code> with reason code from UNIX file system services. Reason code from UNIX file system services must be broken up. The low order 2 bytes can be looked up in <i>z/OS UNIX System Services Programming: Assembler Callable Services Reference</i> .
<code>__LFS_LSEEK</code>	Sets <code>__error</code> with reason code from UNIX file system services. Reason code from UNIX file system services must be broken up. The low order 2 bytes can be looked up in <i>z/OS UNIX System Services Programming: Assembler Callable Services Reference</i> .
<code>__LFS_OPEN</code>	Sets <code>__error</code> with reason code from UNIX file system services. Reason code from UNIX file system services must be broken up. The low order 2 bytes can be looked up in <i>z/OS UNIX System Services Programming: Assembler Callable Services Reference</i> .
<code>__LFS_READ</code>	Sets <code>__error</code> with reason code from UNIX file system services. Reason code from UNIX file system services must be broken up. The low order 2 bytes can be looked up in <i>z/OS UNIX System Services Programming: Assembler Callable Services Reference</i> .
<code>__LFS_STAT</code>	Sets <code>__error</code> with reason code from UNIX file system services. Reason code from UNIX file system services must be broken up. The low order 2 bytes can be looked up in <i>z/OS UNIX System Services Programming: Assembler Callable Services Reference</i> .
<code>__LFS_WRITE</code>	Sets <code>__error</code> with reason code from UNIX file system services. Reason code from UNIX file system services must be broken up. The low order 2 bytes can be looked up in <i>z/OS UNIX System Services Programming: Assembler Callable Services Reference</i> .
<code>__OS_CLOSE</code>	Sets <code>__error</code> to result of OS CLOSE macro.
<code>__OS_OPEN</code>	Sets <code>__error</code> to result of OS OPEN macro.



Table 34. *\_\_last\_op codes and diagnosis information (continued)*

Code	More Information
__QSAM_FREEPOOL	This is an intermediate operation. You will only see this if an I/O abend occurred.
__QSAM_GET	__error is not set (if abend (errno == 92), __abend is set, otherwise if read error (errno == 66), look at __msg.
__QSAM_PUT	__error is not set (if abend (errno == 92), __abend is set, otherwise if write error (errno == 65), look at __msg.
__QSAM_TRUNC	This is an intermediate operation. You will only see this if an I/O abend occurred.
__SVC99_ALLOC	Sets __alloc structure with info and error codes from SVC 99 allocation.
__SVC99_ALLOC_NEW	Sets __alloc structure with info and error codes from SVC 99 allocation of NEW file.
__SVC99_UNALLOC	Sets __alloc structure with info and error codes from SVC 99 unallocation. The __QSAM_CLOSE and __QSAM_OPEN codes do not exist. They should be __OS_CLOSE and __OS_OPEN instead.
__TGET_READ	Sets __error with return code from TSO TGET macro.
__TPUT_WRITE	Sets __error with return code from TSO TPUT macro.
__VSAM_CLOSE	Set when the last op was a low level VSAM CLOSE; if the CLOSE fails, sets __rc and __fdbk in the __amrc struct.
__VSAM_ENDREQ	Set when the last op was a low level VSAM ENDREQ; if the ENDREQ fails, sets __rc and __fdbk in the __amrc struct.
__VSAM_ERASE	Set when the last op was a low level VSAM ERASE; if the ERASE fails, sets __rc and __fdbk in the __amrc struct.
__VSAM_GENCB	Set when a low level VSAM GENCB macro fails, sets __rc and __fdbk fields in the __amrc struct.
__VSAM_GET	Set when the last op was a low level VSAM GET; if the GET fails, sets __rc and __fdbk in the __amrc struct.
__VSAM_MODCB	Set when a low level VSAM MODCB macro fails, sets __rc and __fdbk fields in the __amrc struct.
__VSAM_OPEN_ESDS	Does not indicate an error; set when the low level VSAM OPEN succeeds, and the file type is ESDS.
__VSAM_OPEN_ESDS_PATH	Does not indicate an error; set when the low level VSAM OPEN succeeds, and the file type is ESDS.
__VSAM_OPEN_FAIL	Set when a low level VSAM OPEN fails, sets __rc and __fdbk fields in the __amrc struct.
__VSAM_OPEN_KSDS	Does not indicate an error; set when the low level VSAM OPEN succeeds, and the file type is ESDS.
__VSAM_OPEN_KSDS_PATH	Does not indicate an error; set when the low level VSAM OPEN succeeds, and the file type is ESDS.
__VSAM_OPEN_RRDS	Does not indicate an error; set when the low level VSAM OPEN succeeds, and the file type is ESDS.
__VSAM_POINT	Set when the last op was a low level VSAM POINT; if the POINT fails, sets __rc and __fdbk in the __amrc struct.
__VSAM_PUT	Set when the last op was a low level VSAM PUT; if the PUT fails, sets __rc and __fdbk in the __amrc struct.
__VSAM_SHOWCB	Set when a low level VSAM SHOWCB macro fails, sets __rc and __fdbk fields in the __amrc struct.

Table 34. `__last_op` codes and diagnosis information (continued)

Code	More Information
<code>__VSAM_TESTCB</code>	Set when a low level VSAM TESTCB macro fails, sets <code>__rc</code> and <code>__fdbk</code> fields in the <code>__amrc</code> struct.

---

## Using the SIGIOERR signal

SIGIOERR is a signal used by the library to pass control to an error handler when an I/O error occurs. The default action for this signal is SIG\_IGN. Setting up a SIGIOERR handler is like setting up any other error handler. Example program CCNGDI2 (Figure 42 on page 232) adds a SIGIOERR handler to the example shown in Figure 40 on page 226. Note the way `fldata()` and the `__amrc2` field `__fileptr` are used to get the name of the file that caused the error.

```

#include <stdio.h>
#include <signal.h>
#include <errno.h>
#include <stdlib.h>
#include <string.h>

#ifdef __cplusplus
extern "C" {
#endif
void iohdlr(int);

#ifdef __cplusplus
}
#endif

int main(void) {
    FILE *fp;
    char buffer[80];
    int i = 0;

    signal(SIGIOERR, iohdlr);

    /* open an MVS binary file */

    fp = fopen("testfull.file","wb, recfm=F, lrecl=80");
    if (fp == NULL) exit(99);

    memset(buffer, 'A', 80);

    /* write to MVS file until it runs out of extents */

    while (fwrite(buffer, 1, 80, fp) == 80)
        ++i;

    printf("number of successful fwrites of 80 bytes = %d\n", i);

    return 0;
}

void iohdlr (int signum) {
    __amrc_type save_amrc;
    __amrc2_type save_amrc2;
    char filename[FILENAME_MAX];
    fldata_t info;

```

*Example of using SIGIOERR (Part 1 of 2)*

*Figure 42. Example of using SIGIOERR*

```

save_amrc = *__amrc; /* need copy of __amrc structure */
save_amrc2 = *__amrc2; /* need copy of __amrc2 structure */

/* get name of file causing error from fldata */

if (fldata(save_amrc2.__fileptr, filename, &info) == 0)
    printf("error on file %s\n", filename);

perror("io handler"); /* give errno message */
printf("lastop=%d syscode=%X rc=%d\n",
       save_amrc.__last_op,
       save_amrc.__code.__abend.__syscode,
       save_amrc.__code.__abend.__rc);

signal(SIGIOERR, iohdlr);
}

```

### *Example of using SIGIOERR (Part 2 of 2)*

When control is given to a SIGIOERR handler, the `__amrc2` structure field `__fileptr` will be filled in with a file pointer. The `__amrc2 __fileptr` will be NULL if a SIGIOERR is raised before the file has been successfully opened. The only operation permitted on the file pointer is `fldata()`. This operation can be used to extract information about the file that caused the error. Other than `freopen()` and `fclose()`, all I/O operations will fail since the file pointer is marked invalid. Do not issue `freopen()` or `fclose()` in a SIGIOERR handler that returns control. This will result in unpredictable behavior, likely an `abend`.

If you choose not to return from the handler, the file is still locked from all operations except `fldata()`, `freopen()`, or `fclose()`. The file is considered open and can prevent other incorrect access, such as an MVS sequential file opened more than once for a write. Like all other files, the file is closed automatically at program termination if it has not been closed explicitly already.

When you exit a SIGIOERR handler and do not return, the state of the file at closing is indeterminate. The state of the file is indeterminate because certain control block fields are not set correctly at the point of error and they do not get corrected unless you return from the handler.

For example, if your handler were invoked due to a truncation error and you performed a `longjmp()` out of your SIGIOERR handler, the file in error would remain open, yet inaccessible to all I/O functions other than `fldata()`, `fclose()`, and `freopen()`. If you were to close the file or it was closed at termination of the program, it is still likely that the record that was truncated will not appear in the final file.

You should be aware that for a standard stream passed across a `system()` call, the state of the file will be indeterminate even after you return to the parent program. For this reason, you should not jump out of a SIGIOERR handler. For further information on `system()` calls and standard streams, see Chapter 9, "Using C and C++ standard streams and redirection," on page 63.

I/O with files other than the file causing the error is perfectly valid within a SIGIOERR handler. For example, it is valid to call `printf()` in your SIGIOERR handler if the file causing the error is not `stdout`. Comparing the incoming file pointer to the standard streams is not a reliable mechanism of detecting whether any of the standard streams are in error. This is because the file pointer in some cases is only a pointer to a file structure that points to the same `__file` as the

stream supplied by you. The FILE pointers will not be equal if compared, but a comparison of the `__file` fields of the corresponding FILE pointers will be. See the `stdio.h` header file for details of type FILE.

If `stdout` or `stderr` are the originating files of a SIGIOERR, you should open a special log file in your handler to issue messages about the error.

---

## File I/O trace

The file I/O trace is an EBCDIC encoded trace that can be used as a debugging aid for file I/O failures. The files that are traced, the level of detail provided by the trace, and the trace table size can be controlled with the environment variable `_EDC_IO_TRACE`. For more information about `_EDC_IO_TRACE`, see “`_EDC_IO_TRACE`” on page 495. Figure 43 shows the result of running a file I/O application with the displayed environment variable setting.

---

```
EDCTRACE   File I/O Trace   z/OS XL C/C++ Release: 410B0000   09/28/08 09:14:43 AM

Trace details for /u/bryntco/h1e7760/B49300/ut/tst/myfile.dat:

Trace detail level: 2
Trace buffer size: 2048K

fopen(/u/bryntco/h1e7760/B49300/ut/tst/myfile.dat,w)

fldata:
__recfmF:1..... 0           __dsorgVSAM:1..... 0
__recfmV:1..... 0           __dsorgHFS:1..... 1
__recfmU:1..... 1           __openmode:2..... 1
__recfmS:1..... 0           __modeflag:4..... 2
__recfmBlk:1..... 0         __dsorgPDSE:1..... 0
__recfmASA:1..... 0        __reserve2:4..... 0
__recfmM:1..... 0           __device..... 9
__dsorgPO:1..... 0          __blksize..... 0
__dsorgPDSmem:1... 0        __maxreclen..... 0
__dsorgPDSdir:1... 0        __vsamtype..... 0
__dsorgPS:1..... 0          __vsamkeylen..... 0
__dsorgConcat:1... 0        __vsamRKP..... 0
__dsorgMem:1..... 0         __access_method... 0 (0)
__dsorgHiper:1... 0         __noseek_to_seek.. 0 (0)
__dsorgTemp:1..... 0

FILE pointer..... 21A34030

Trace Entries:
Function Name           Trace Type
openhfs                 Entry
fwrite                  Entry
mwphfs                  Entry
wp124                   Entry
__pcloseall             Entry
cp124                   Entry
```

---

Figure 43. Sample File I/O Trace

---

## Locating the file I/O trace

If your application is running under TSO or batch, and an EDCTRACE DD is not specified, Language Environment writes the trace to the batch log (`SYSOUT=*` by default). You can change the `SYSOUT` class by specifying an EDCTRACE DD, or by setting the environment variable, `_CEE_DMPTARG=SYSOUT(x)`, where `x` is the preferred `SYSOUT` class.

If your application is running under z/OS UNIX and is either running in an address space that you issued a `fork()` to, or if it is invoked by one of the `exec` family of functions, the trace is written to the UNIX file system. Language Environment writes the trace to one of the following directories in the specified order:

1. The directory found in environment variable `_CEE_DMPTARG`, if the directory is found.
2. The current working directory, as long as the directory is writable and the `EDCTRACE` path name does not exceed 1024 characters.
3. The directory found in environment variable `TMPDIR`, which is an environment variable that indicates the location of a temporary directory if it is not `/tmp`.
4. The `/tmp` directory.

The name of the file uses the following format:

`/path/EDCTRACE.Date.Time.Pid`

**path** Path determined from the previous algorithm.

**Date** Date that the trace is taken, appearing in the format `YYYYMMDD`. For example, `20071122` is for November 22, 2007.

**Time** Time that the trace is taken, appearing in the format `HHMMSS`. For example, `115601` is for 11:56:01 a.m.

**Pid** Process ID in which the application is running when the trace is taken.



---

## Part 3. Interlanguage Calls with z/OS XL C/C++

This part describes z/OS XL C/C++ considerations about interlanguage calls in the z/OS Language Environment. For complete information about interlanguage calls (ILC) with z/OS XL C/C++ and z/OS Language Environment, refer to *z/OS V2R1.0 Language Environment Writing Interlanguage Communication Applications*.

- Chapter 19, “Using Linkage Specifications in C or C++,” on page 239
- Chapter 20, “Combining C or C++ and Assembler programs,” on page 245





---

## Chapter 19. Using Linkage Specifications in C or C++

This information describes how you can make calls between C or C++ programs and assembler, COBOL, PL/I, or FORTRAN programs, or other C or C++ programs. For complete information on making interlanguage calls to and from C or C++, see *z/OS V2R1.0 Language Environment Writing Interlanguage Communication Applications*.

With XPLINK compilation, the linkage and parameter-passing mechanisms for C and C++ are identical. If you link to a C function from a C++ program, you should still specify `extern "C"` to avoid name mangling. For more information about XPLINK, see *z/OS Language Environment Programming Guide*.

---

### Syntax for Linkage in C or C++

You can specify one of the following linkage types:

Linkage Type	Description
C	C linkage (C++ only)
C++	C++ linkage (C++ only, the default for C++)
COBOL	Previously used for linkage to COBOL routines. Maintained for compatibility with COBOL/370 and VS COBOL II. With newer COBOL products, use the REFERENCE, OS, or C linkage type instead.
FORTRAN	FORTRAN linkage
OS	Operating System linkage
OS_DOWNSTACK	XPLINK-enabled operating system linkage
OS_NOSTACK	Minimal operating system linkage (for use with XPLINK)
OS_UPSTACK	Complete operating system linkage (for use with XPLINK)
OS31_NOSTACK	Same as OS_NOSTACK
PLI	Maintained for compatibility with PL/I products prior to the Enterprise PL/I for z/OS product. With newer PL/I products use the C linkage type instead.
REFERENCE	A Language Environment reference linkage that has the same syntax and semantics with and without XPLINK. Unlike OS linkage, REFERENCE linkage is not affected by the OSCALL suboption of XPLINK. It is equivalent to OS_DOWNSTACK in XPLINK mode and OS_UPSTACK in non-XPLINK mode.

### Syntax for Linkage in C

You can create linkages between C and other languages by using linkage specifications with the following `#pragma linkage` directive, where *identifier* specifies the name of the function and *linkage* specifies the linkage associated with the function.

```
#pragma linkage(identifier, linkage)
```

## Syntax for Linkage in C++

You can create linkages between C++ and other languages by using linkage specifications with the following syntax, where *linkage* specifies the linkage associated with the function. If z/OS XL C++ does not recognize the linkage type, it uses C linkage.

```
extern "linkage" { [declaration-list] }
extern "linkage" declaration

declaration-list:
    declaration
    declaration-list declaration
```

## Kinds of Linkage used by C or C++ Interlanguage Programs

Table 35 describes the kinds of linkage used by C++ interlanguage programs.

Table 35. Linkage used by C or C++ Interlanguage Programs

What calls or is called by a C or C++ program	Linkage used	Description of linkage	C++ Example
GDDM, ISPF, or non-Language Environment conforming assembler	OS	Basic linkage defined by the operating system. OS Linkage allows integer, pointer, and floating point return types. Use of OS linkage with assembler is detailed in "Specifying linkage for C or C++ to Assembler" on page 246.	extern "OS" { ... }
Language Environment conforming assembler, NOXPLINK-compiled C or C++ declared with OS linkage (or C linkage, passing each parameter as a pointer) is to be called from XPLINK-compiled C or C++. Cannot be used on a function definition in XPLINK-compiled code.	OS_UPSTACK	This is the same as OS linkage in NOXPLINK-compiled programs. It is declared this way by the caller when the caller is XPLINK-compiled. The compiler will call glue code to transition from the XPLINK caller to the non-XPLINK callee. Also, see the OSCALL suboption of the XPLINK option in <i>z/OS XL C/C++ User's Guide</i> .	extern "OS_UPSTACK" { ... }
Assembler that does not follow Language Environment conventions.	OS_NOSTACK, OS31_NOSTACK	The compiler does not generate any glue code for this call. It provides the called program with a 72-byte save area pointed to by Register 13, as does OS_UPSTACK, but the save area may not be initialized. In particular, the Language Environment Next Available Byte (NAB) field may not be present. On entry to the called function, Register 15 contains the entry point address and Register 14 contains the return address. Register 1 points to an OS-style argument list. Typically a program would declare an operating system or subsystem assembler routine with this linkage, where such a routine was not Language Environment enabled.	extern "OS31_NOSTACK" { ... }

Table 35. Linkage used by C or C++ Interlanguage Programs (continued)

What calls or is called by a C or C++ program	Linkage used	Description of linkage	C++ Example
XPLINK-compiled C or C++ using OS_DOWNSTACK linkage, or XPLINK-enabled assembler.	OS_DOWNSTACK	As with OS linkage in NOXPLINK-compiled C or C++, the parameters are passed by reference rather than by value. However, parameter and stack management use XPLINK conventions. Also, see the OSCALL suboption of the XPLINK option in <i>z/OS XL C/C++ User's Guide</i> .	extern "OS_DOWNSTACK" { ... }
The following programs, using by-reference parameter passing: <ul style="list-style-type: none"> <li>• XPLINK-compiled C/C++ programs calling XPLINK functions (C, C++, or Language Environment conforming assembler)</li> <li>• NOXPLINK-compiled C/C++ programs calling NOXPLINK functions (C, C++, or Language Environment conforming assembler)</li> </ul> <p>A Language Environment conforming stack frame is always provided. This is not affected by the OSCALL suboption of XPLINK.</p>	REFERENCE	This is the same as OS_DOWNSTACK linkage in XPLINK-compiled programs and OS_UPSTACK in NOXPLINK-compiled programs. Use this for Language Environment-conforming assembler linkage.	extern "REFERENCE" { ... }
PL/I	PLI	Modification of OS linkage. It forces the compiler to read and write parameter lists using PL/I linkage conventions. This linkage type extends OS linkage by allowing structures as return types. (When the return type is a structure, the caller allocates a buffer large enough to receive the returned structure and passes it, by reference, as a hidden final argument.) <p>This linkage type is maintained for compatibility with PL/I products prior to the Enterprise PL/I for z/OS product. With newer PL/I products use the C linkage type instead.</p>	extern "PLI" { ... }

Table 35. Linkage used by C or C++ Interlanguage Programs (continued)

What calls or is called by a C or C++ program	Linkage used	Description of linkage	C++ Example
COBOL	COBOL	Forces the compiler to read and write parameter lists using COBOL linkage conventions. All calls from C++ to COBOL must be void functions.  This linkage type is maintained for compatibility with COBOL/370 and VS COBOL II. With newer COBOL products, you can call COBOL functions with the REFERENCE and OS linkage types, which allow integer return types. If the COBOL routine receives parameters by value (a pragmaless call), you can use the C linkage type.	extern "COBOL" { ... }
FORTRAN	FORTRAN	Forces the compiler to read and write parameter lists using FORTRAN linkage conventions.	extern "FORTRAN" { ... }
C	C	Use in C++ to force the compiler to read and write parameter lists using C linkage conventions. C code and the Data Window Services (DWS) product both use C linkage.  With XPLINK, C and C++ use the same linkage conventions. When this linkage is specified in C++ code, the specified function is known by its function name alone rather than its name and argument types. It cannot be overloaded.	extern "C" { ... }

## Using Linkage Specifications in C++

In the following example, a function is prototyped in a piece of C++ code and uses, by default, C++ linkage.

```
void CXX_FUNC (int); // C++ linkage
```

Note that C++ is case-sensitive, but PL/I, COBOL, assembler, and FORTRAN are not. In these languages, external names are mapped to uppercase. To ensure that external names match across interlanguage calls, code the names in uppercase in the C++ program, supply an appropriate #pragma map specification, or use the NOLONGNAME compiler option. This will truncate and uppercase names for functions without C++ linkage.

To reference functions defined in other languages, you should use a linkage specification with a literal string that is one of the following:

- C
- COBOL
- FORTRAN
- OS
- OS\_DOWNSTACK
- OS\_NOSTACK

- OS\_UPSTACK
- OS31\_NOSTACK
- PLI
- REFERENCE

For example, the following specification declares the two functions ASMFUNC1 and ASMFUNC2 to have operating system linkage. The function names are case-sensitive and must match the definition exactly. You should also limit identifiers to 8 or fewer characters.

```
extern "OS" {  
    int ASMFUNC1(void);  
    int ASMFUNC2(int);  
}
```

Use the reference type parameter (type&) in C++ prototypes if the called language does not support pass-by-value parameters or if the called routine expects a parameter to be passed by reference.

**Note:** To have your program be callable by any of these other languages, include an extern declaration for the function that the other language will call.



---

## Chapter 20. Combining C or C++ and Assembler programs

This chapter describes how to communicate between z/OS XL C/C++ and assembler programs. To write assembler code that can be called from z/OS XL C/C++, use the prolog and epilog macros described in this chapter. For more information about how the z/OS Language Environment works with assembler, see *z/OS Language Environment Programming Guide*, and *z/OS V2R1.0 Language Environment Writing Interlanguage Communication Applications*.

z/OS Language Environment provides a set of assembler macros for use with 64-bit assembler programs. For information about writing 64-bit assembler programs see *z/OS V2R1.0 Language Environment Programming Guide for 64-bit Virtual Addressing Mode*.

Access to z/OS UNIX is intended to be through the z/OS UNIX XL C/C++ runtime library only. The z/OS XL C/C++ compiler does not support the direct use of z/OS UNIX callable services such as the assembler interfaces. You should not directly use z/OS UNIX callable services from your z/OS XL C/C++ application programs, because problems can occur with the processing of the following:

- Signals
- Library transfers
- `fork()`
- `exec()`
- Threads

There are comparable z/OS XL C/C++ runtime library functions for most z/OS UNIX callable services, and you should use those instead. Do not call assembler programs that access z/OS UNIX callable services.

---

### Establishing the z/OS XL C/C++ environment

Before you can call a C or C++ function from assembler, you must establish a suitable environment. To establish the environment, do one of the following:

- Call the assembler program from within the C or C++ program (from `main()` or another function). Since the assembler call is from within the C or C++ program, the environment has already been established. It is often simplest to call the assembler using OS linkage conventions.

**Note:** In this , "OS linkages" and "OS linkage" conventions refer to the following group of specifications: OS, OS\_UPSTACK, OS\_DOWNSTACK, OS\_NOSTACK, OS31\_NOSTACK and REFERENCE. "OS" is used in syntax diagrams and examples as a representative specification. These specifications use different stack conventions. For more information on these specifications, see Chapter 19, "Using Linkage Specifications in C or C++," on page 239.

- Use preinitialization to set up the z/OS Language Environment. See "Retaining the C environment using preinitialization" on page 258 for information.
- Use the Language Environment CEEENTRY prolog macro with MAIN=YES specified so that z/OS Language Environment is initialized.

Once you are in the assembler program, you can call other C or C++ programs from the assembler.



---

## Specifying linkage for C or C++ to Assembler

The process for specifying the linkage to assembler differs for C and for C++. In C, a `#pragma linkage` directive is used, while in C++ a linkage specifier is used.

- Under C, a `#pragma linkage` directive enables the compiler to generate and accept parameter lists, using a linkage convention known as OS linkage. Although functionally different, both *calling* an assembler routine and *being called by* one are handled by the same `#pragma`. Its format is shown below, where *identifier* is the name of the assembler function to be called from C or the C function to be called from assembler. The `#pragma linkage` directive must occur before the call to the entry point.

```
#pragma linkage(identifier, OS)
```

- Under C++, a linkage specifier enables the compiler to generate and accept parameter lists, using a linkage convention known as OS linkage. Although functionally different, both *calling* an assembler routine and *being called by* one are handled by the same linkage specifier. The format of the linkage specifier is shown below, where *fnx desc* is the name of the OS entry point:

```
extern "OS" {  
    fn1 desc;  
    fn2 desc;  
    :  
}
```

**Note:** For C and C++, in XPLINK compiled code, the `OS_UPSTACK` and `OS_NOSTACK` (or `OS31_NOSTACK`) linkages are used for declaring the linkage convention of a routine that the C or C++ code is *calling*. You cannot define C or C++ entry points as having `OS_NOSTACK` linkage. You define C or C++ entry points with `OS_UPSTACK` linkage by compiling the translation units containing them with the `NOXPLINK` compiler option. In `NOXPLINK` compiled code, the `OS_DOWNSTACK` linkage is used to declare the linkage convention for a routine that the C or C++ code is *calling*. You define C or C++ entry points with `OS_DOWNSTACK` linkage by compiling the translation units containing them with the `XPLINK` compiler option.

Just as C (or C++) linkage programs can call OS linkage programs, OS linkage programs can call C linkage programs. An example of C linkage calling OS linkage, which in turn calls C linkage (in this case, one of the z/OS XL C/C++ library functions) is shown in Figure 48 on page 255.

In general, any type that can be passed between C and assembler can also be passed between C++ and assembler. However, if a C++ class that uses features not available to assembler (such as virtual functions, virtual base classes, private and protected data, or static data members) is passed to assembler, the results will be undefined.

**Note:** In C++, a structure is just a class declared with the keyword `struct`. Its members and base classes are public by default. A union is a class declared with the keyword `union` its members are public by default, and it holds only one member at a time.

---

## Parameter lists for OS linkage

A parameter list for OS linkage is a list of pointers. The most significant bit of the last parameter in the parameter list is turned on by the compiler when the list is created.

If a parameter is an address-type parameter, the address itself is directly stored into the parameter list. Otherwise, a copy is created for a value parameter and the address of this copy is stored into the parameter list.

The type of a parameter is specified by the prototype of a function. In the absence of a prototype, the creation of a parameter list is determined by the types of the actual parameters passed to the function. Figure 44 shows an example of the parameter list for OS linkage.

In the list, the first and third parameters are value parameters, and the second is an address parameter.

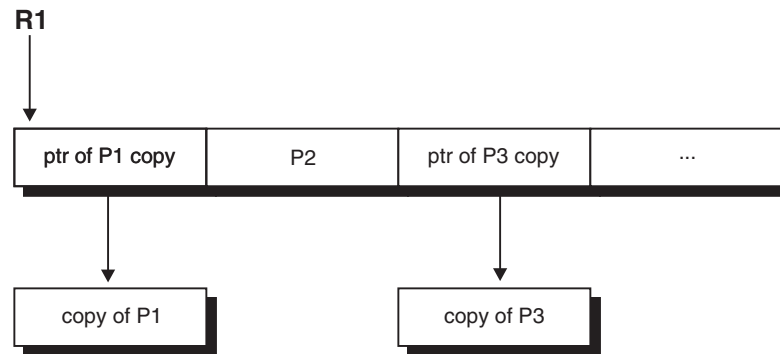

Figure 44. Example of parameter lists For OS linkages

---

## XPLINK Assembler

The XPLINK support provided by the assembler macros EDCXPRLG and EDCXEPLG allows XPLINK C and C++ code to call routines that can be coded for performance, or to perform a function that can not be readily done in C/C++. The EDCXCALL macro allows XPLINK assembler to call routines in the same program object, or in a DLL. The following z/OS Language Environment books provide more information on XPLINK that may be useful to assembler programmers:

- *z/OS Language Environment Programming Guide* — provides an overview of XPLINK and what it means to the application programmer. It also describes the Language Environment assembler support, including the CEEPDDA and CEEPLDA macros, which can be used to define and reference data from assembler.
- *z/OS V2R1.0 Language Environment Writing Interlanguage Communication Applications* — provides information on how assembler routines interact with routines coded in other high level languages.
- *z/OS Language Environment Debugging Guide* — provides details on XPLINK, including information on building parameter lists for calling other XPLINK routines.

Coding XPLINK assembler routines differs from traditional non-XPLINK assembler in the following ways:

- You use the EDCXPRLG and EDCXEPLG macros for entry/exit code, and the EDCXCALL macro to call other routines. These are documented in the section “Using standard macros” on page 249.
- You use the following XPLINK register conventions within the XPLINK assembler routine:

- XPLINK parameter passing conventions: Registers 1, 2, and 3 are used to pass up to the first 3 integral values, and floating point registers will be used to pass floating point parameters.
- XPLINK DSA format: Note that the stack register (reg 4) is "biased". This means that you must add 2K (2048) to the stack register to get the actual start of the current routine's DSA. The z/OS Language Environment mapping macro CEEDSA contains a mapping of the XPLINK DSA, including the 2K bias (CEEDSAHP\_BIAS). The caller's registers are saved in the DSA obtained by the callee. The callee's parameters (other than those passed in registers, if any), are built in the argument list in the callers DSA, and addressed there directly by the callee. There is no indirect access to the parameters via Register 1 as in OS linkage.
- While EDCXPRLG and EDCXEPLG allow Language Environment conforming XPLINK assembler routines to be written, another alternative for XPLINK C/C++ callers is to designate the linkage as OS31\_NOSTACK. For more information on OS31\_NOSTACK see Chapter 19, "Using Linkage Specifications in C or C++," on page 239. When the C/C++ caller designates the assembler routine as OS31\_NOSTACK linkage, the assembler code can be written without using EDCXPRLG or EDCXEPLG (or any other Language Environment prolog or epilg macros). This can only be done when the assembler code has no dynamic stack storage requirements. With OS31\_NOSTACK, standard OS linkage rules apply:
  - Register 1 will be used to point to the parameter list.
  - Register 13 will point to an 18 word savearea, provided to the callee for saving and restoring registers.
  - Register 14 will be the return address for branching back to the caller.
  - Register 15 will contain the address of the callee.

Table 36 shows the layout of the XPLINK interface. See *z/OS Language Environment Vendor Interfaces* for additional information about register usage and conventions, especially for details about passing parameters with XPLINK. For information on the registers which are saved in the register savearea of the XPLINK stack frame see *z/OS Language Environment Programming Guide*.

Table 36. Comparison of non-XPLINK and XPLINK register conventions

	Non-XPLINK	XPLINK
Stack Pointer	Reg 13	Reg 4 (biased)
Return Address	Reg 14	Reg 7
Entry point on entry	Reg 15	Reg 6 (not guaranteed; a routine may be called via branch relative)
Environment	Reg 0 (writeable static)	Reg 5
CAA Address	Reg 12	Reg 12
Input Parameter List	address in R1	Located at fixed offset 64 ('40'x) into the caller's stack frame (remember the 2K bias on R4). Additionally, any of General Registers 1, 2, and 3, and Floating Point Registers 0, 2, 4, and 6, may be used to pass parameters instead of the caller's stack frame.
Return code	Reg 15	R3 (extended return value in R1,R2)
Start address of callee's stack frame	Caller's NAB value	Caller's Reg 4 - DSA size
End address of callee's stack frame	Caller's NAB value + DSA size	Caller's Reg 4

Table 36. Comparison of non-XPLINK and XPLINK register conventions (continued)

	Non-XPLINK	XPLINK
Where caller's registers are saved	<ul style="list-style-type: none"> <li>• R0-R12 saved in caller's stack frame</li> <li>• R13 saved in callee's stack frame</li> <li>• R14-R15 saved in caller's stack frame</li> </ul>	<ul style="list-style-type: none"> <li>• R0 not saved, not preserved</li> <li>• R1-R3 not saved, not preserved</li> <li>• R4 not saved, recalculated (or saved, restored)</li> <li>• R5 not saved, not preserved</li> <li>• R6 saved in callee's stack frame, not restored</li> <li>• R7-R15 saved in callee's stack frame (R7 is the return register and is not guaranteed to be restored)</li> </ul>

## Using standard macros

To communicate properly, assembler routines must preserve the use of certain registers and particular storage areas, in a way that is consistent with code from the C or C++ compiler. z/OS XL C/C++ provides macros for use with assembler routines. These macros are in CEE.SCEEMAC. The High-Level Assembler for MVS & VM & VSE must be used when assembling with these macros. The macros are:

### EDCPRLG

Generates the prolog for non-XPLINK assembler code

### EDCEPIL

Generates the epilog for non-XPLINK assembler code

### EDCXPRLG

Generates the prolog for XPLINK assembler code

### EDCXCALL

Generates a call from XPLINK assembler code

### EDCXEPLG

Generates the epilog for XPLINK assembler code

### EDCDSAD

Accesses automatic memory in the non-XPLINK stack. For the XPLINK stack, use the CEEDSA macro, described in *z/OS Language Environment Programming Guide*.

EDCPR0L, the old version of EDCPRLG, is shipped for compatibility with Version 1 of C/370 and is unchanged. However, you should use EDCPRLG if you can.

The advantage of writing assembler code using these macros is that the assembler routine will then participate fully in the z/OS XL C/C++ environment, enabling the assembler routine to call z/OS XL C/C++ functions. The macros also manage automatic storage, and make the assembler code easier to debug because the z/OS Language Environment control blocks for the assembler function will be displayed in a formatted traceback or dump. See the Debug Tool documentation, which is available at <http://www-01.ibm.com/software/awdtools/debugtool/library/>, for further information on z/OS Language Environment tracebacks and dumps:

<http://www-01.ibm.com/software/awdtools/debugtool/library/>

## Non-XPLINK assembler prolog

Use the EDCPRLG macro to generate non-XPLINK assembler prolog code at the start of assembler routines.

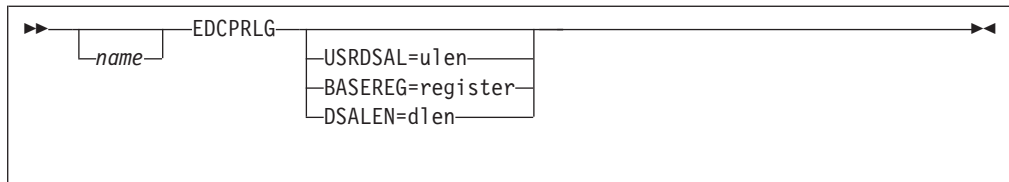

*name* Is inserted in the prolog. It is used in the processing of certain exception conditions and is useful in debugging and in reading memory dumps. If *name* is absent, the name of the current CSECT is used.

**USRDSAL=ulen**

Is used only when automatic storage (in bytes) is needed. To address this storage, see the EDCDSAD macro description. The *ulen* value is the requested length of the user space in the DSA.

**BASEREG=register**

Designates the required base register. The macro generates code needed for setting the value of the register and for establishing addressability. The default is Register 3. If *register* equals NONE, no code is generated for establishing addressability.

**DSALEN=dlen**

Is the total requested length of the DSA. The default is 120. If fewer than 120 bytes are requested, 120 bytes are allocated. If both *dlen* and *ulen* are specified, then the greater of *dlen* or *ulen*+120 is allocated. If DSALLEN=NONE is specified, no code is generated for DSA storage allocation, and R13 will still point to the caller's DSA. Therefore, you should not use the EDCEPIL macro to terminate the assembler routine. Instead, you have to restore the registers yourself from the current DSA. To do this, you can use an assembler instruction such as

```
LM 14,12,12(R13)
BR 14
```

You should not use EDCDSAD to access automatic memory if you have specified DSALLEN=NONE, since DSECT is addressable using R13.

## Non-XPLINK assembler epilog

Use the EDCEPIL macro to generate non-XPLINK assembler epilog code at the end of assembler routines. Do not use this macro in conjunction with an EDCPRLG macro that specifies DSALLEN=NONE.

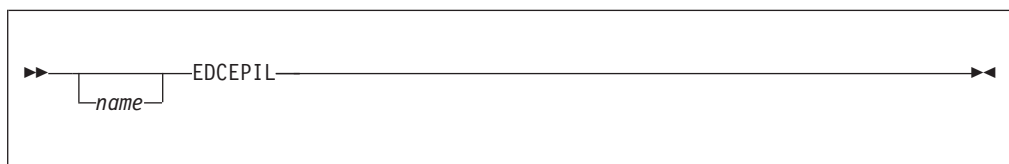

*name* Is the optional name operand, which then becomes the label on the exit from this code. The name does not have to match the prolog.

## XPLINK Assembler prolog

Use the EDCXPRLG macro to generate XPLINK assembler prolog code at the start of assembler routines.

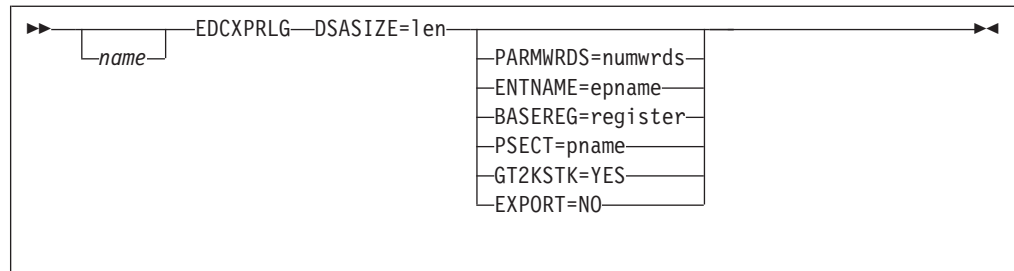

*name* If ENTNAME=epname is specified then *name* is used as the name of the XPLINK entry marker, else *name* is the name of the entry point and name#C is used as the name of the XPLINK entry marker.

**DSASIZE=len**

Specifies automatic storage requirements (in bytes). Specify a *len* of 0 if the XPLINK assembler routine is a leaf routine with no automatic storage requirements. XPLINK leaf routines must preserve registers 4,6, and 7 throughout their execution. This is a required parameter, the minimum size of an XPLINK DSA (80 bytes) or more must be specified if DSASIZE is not zero. The length will be rounded up, if necessary, to a multiple of 32-bytes.

**PARMWRDS=numwrds**

Specifies the number of 4-byte words in the input parameter list. If this is omitted, then the routine will be treated as vararg, and it will adversely affect performance if the call to this routine results in a stack overflow. This parameter is required if mixing XPLINK and non-XPLINK routines so that the glue code that switches between linkage conventions on a call can correctly pass the parameters. If this is omitted, then a call from a non-XPLINK caller to an XPLINK Assembler routine will abend with message CEE3584E.

**ENTNAME=epname**

Is the optional name of the XPLINK assembler routine entry point.

**BASEREG=register**

Designates the required base register. The macro generates code needed for setting the value of the register and for establishing addressability. The default is register 8. If *register* equals NONE, no code is generated for establishing addressability.

**PSECT=pname**

Is the name to be assigned to the XPLINK assembler routine PSECT area. For more information about the PSECT area see *HLASM Language Reference*.

**GT2KSTK=YES**

If GT2KSTK=YES is specified, then an unconditional "large stack frame" prolog will be used that checks for the XPLINK stack floor in the CAA, instead of depending on the write-protected guard page. This parameter must be specified if the *len* on the DSASIZE parameter is greater than 2048 (ie. 2K).

**EXPORT=NO**

If EXPORT=NO is specified, then this function is not exported. In this case, this function can be called only from other functions that are link-edited in the same program object with this function.

If EXPORT=YES is specified, then this function is to be exported when link-edited into a DLL. With this function exported from the DLL, it can be called from functions outside of the containing program object. If you want

the exported name to be a long name and/or mixed case, follow the EDCXPRLG macro with an ALIAS statement. For example:

---

```

* EDCXPRLG macro with an ALIAS statement
ASMDLLEP EDCXPRLG DSASIZE=0,BASEREG=8,EXPORT=YES
ASMDLLEP ALIAS C'dllfunx'
* Symbolic Register Definitions and Usage
R3      EQU   3          Return value
*
      WTO   'ADLLXEF1: Exported function dllfunx entered',ROUTCDE=11
*
RETURN  DS    0H
      SR    R3,R3
      EDCXEPLG
      END    ASMDLLEP

```

---

Figure 45. EDCXPRLG macro with an ALIAS statement

**Note:** If you specify EXPORT=YES, then you must use the GOFF assembler option. For the entry point to be available as an exported DLL function, you must specify the DYNAM(DLL) binder option, and the resulting program object must reside in a PDSE or the UNIX file system.

## XPLINK Call

Use the EDCXCALL macro to pass control from an XPLINK assembler program to a control section at a specified entry point. It is meant to be used in conjunction with the EDCXPRLG and EDCXEPLG macros. The target of EDCXCALL can be resolved either statically (link-edited with the same program object) or dynamically (imported from a DLL).

The EDCXCALL macro does not generate any return codes. Return information may be placed in GPR 3 (and possibly GPRs 2 and 1, or the Floating Point Registers) by the called program, as specified by XPLINK linkage conventions. The EDCXCALL macro does not support extended return types. For more information, refer to *z/OS Language Environment Vendor Interfaces*.

GPRs 0, 1, 2, 3, 5, 6, and 7 are not preserved by this macro.

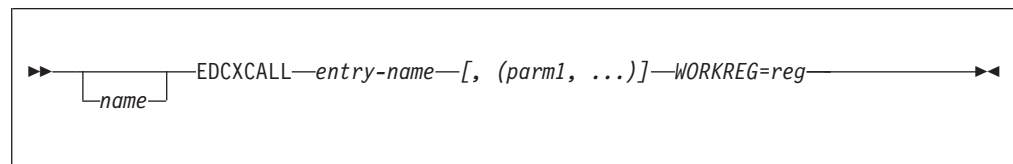

*name* Optional label beginning in column 1.

### entry-name=

Specifies the entry name of the program to be given control. This entry name can reside in the same program object, or can be an exported DLL function.

### [, (parm1, ...)]

One or more parameters to be passed to the called program. The parameters are copied to the argument area in the calling program's DSA, and then GPRs 1, 2, and 3 are loaded with the first three words of this argument area. Sufficient space must be reserved in the caller's argument area to contain the largest possible parameter list. A minimum of 4 words (16 bytes) must always be allocated for the argument area. Use the



DSASIZE= parameter on the EDCXPRLG prolog macro to ensure that the calling program's DSA is large enough. At this time, the EDCXCALL macro only supports passing parameters by reference.

**WORKREG=**

A numeric value representing a general purpose register between 8 and 15, inclusive, that can be used as a work register by this macro. Its contents will not be preserved.

**Notes:**

1. This macro requires that the calling routine's XPLINK environment address is in register 5 (as it was when the routine was first invoked).
2. This macro requires that a PSECT was defined by the EDCXPRLG prolog macro.
3. This macro requires the GOFF assembler option.
4. This macro requires the binder to link-edit, and the RENT and DYNAM(DLL) binder options. You will also need the CASE(MIXED) binder option if the entry-name is mixed case.
5. The output from the binder must be a PM3 (or higher) format program object, and therefore must reside in either a PDSE or the UNIX file system.

Figure 46 shows an XPLINK assembler example (program CCNGCA9) that calls an XPLINK routine named Xif1 where no parameters are passed.

---

```
* Call to an XPLINK routine with no parameters
ADLAXIF1 EDCXPRLG DSASIZE=DSASZ,PSECT=ADLAXIFP
*
R3      EQU   3          RETURN VALUE
*
        WTO   'ADLAXIF1: Calling imported XPLINK function Xif1',      X
        ROUNTCDE=11
*
        EDCXCALL Xif1,WORKREG=10
*
        SR    R3,R3
RETURN  DS    0H
        EDCXEPLG
*
        LTOrg
CEEDSAHP CEEDSA SECTYPE=XPLINK
MINARGA  DS    4F
DSASZ    EQU  *-CEEDSAHP_FIXED
        END    ADLAXIF1
```

---

*Figure 46. Call to an XPLINK routine with no parameters*

Figure 46 (program CCNGCA10) is an XPLINK assembler example that calls a function with 5 parameters.



```

* Call to an XPLINK routine with 5 parameters
ADLAXIF7 EDCXPRLG DSASIZE=DSASZ,PSECT=ADLAXIFP
*
R3      EQU 3          RETURN VALUE
*
      WTO 'ADLAXIF7: Calling imported XPLINK function Xif7 passingX
          parameters (15,33,"Hello world",45.2,9)',          X
          ROUTCDE=11
*
      EDCXCALL Xif7,(PARM1,PARM2,PARM3,PARM4,PARM5),WORKREG=10
*
      SR R3,R3
RETURN  DS  0H
      EDCXEPLG
*
      LTORG
PARM1  DC  FL4'15'
PARM2  DC  FL2'33'
PARM3  DC  C'Hello world'
      DC  X'00'
PARM4  DC  D'45.2'
PARM5  DC  FL4'9'
CEEDSAHP CEEDSA SECTYPE=XPLINK
ARGAREA DS  5F
DSASZ  EQU *-CEEDSAHP_FIXED
      END      ADLAXIF7

```

Figure 47. Call to an XPLINK routine with 5 parameters

## XPLINK Assembler epilog

Use the EDCXEPLG macro to generate XPLINK assembler epilog code at the end of assembler routines. This macro must always be used with a matching EDCXPRLG macro, even if the EDCXPRLG macro specified DSASIZE=0.

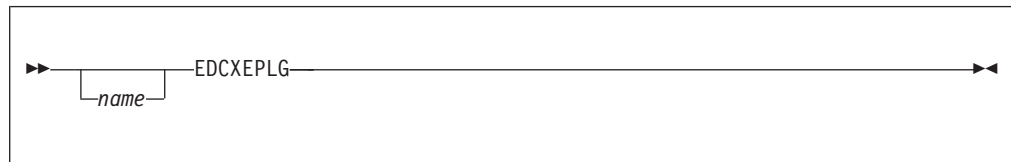

*name* Is the optional name operand, which then becomes the label on the exit from this code. The name does not have to match the prolog.

## Accessing automatic memory in the non-XPLINK stack

Use the EDCDSAD macro to access automatic memory in the non-XPLINK stack.. Automatic memory is reserved using the USRDSAL, or the DSALEN operand of the EDCPRLG macro. The length of the allocated area is derived from the *ulen* and/or *dlen* values specified on the EDCPRLG macro. EDCDSAD generates a DSECT, which reserves space for the stack frame needed for the C or C++ environment.

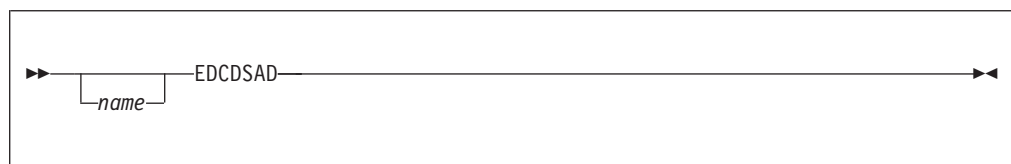

*name* Is the optional name operand, which then becomes the name of the generated DSECT.

The DSECT is addressable using Register 13. Register 13 is initialized by the prolog code. If you have specified DSALEN=NONE with EDCPRLG you should not use EDCDSAD.

The Language Environment mapping macro CEEDSA can be used to map a DSA, either non-XPLINK or XPLINK or both.

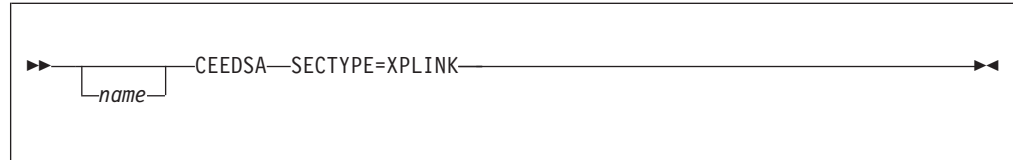

There are other SECTYPE operands. SECTYPE=XPLINK will only produce an XPLINK DSA mapping. For more information on CEEDSA see *z/OS Language Environment Programming Guide*.

---

## Calling C code from Assembler — C example

This section shows samples of how to C code from assembler. There are three parts to this example.

The first code example (CCNGCA4) shown in Figure 48 is a trivial C routine that establishes the C runtime environment.

---

```
/* this example demonstrates C/Assembler ILC */
/* part 1 of 3 (other files are CCNGCA2, CCNGCA5) */
/* in this example, the code in CCNGCA4 invokes CCNGCA2, */
/* which in turn invokes CCNGCA5 */
/* you can use EDCCBG to do the compile and bind, but */
/* you must include the objects from CCNGCA2 and CCNGCA5 */

#pragma linkage(CALLPRTF, OS)

int main(void) {
    CALLPRTF();

    return(0);
}
```

---

*Figure 48. Establishing the C runtime environment*

The second part, shown in Figure 49 on page 256, is the assembler routine (CNGCA2). It calls an intermediate C function that invokes a runtime library function.

---

```

* this example demonstrates ILC with Assembler-part 2 of 3
CALLPRTF CSECT
    EDCPRLG
    LA    1,ADDR_BLK           parameter address block in r1
    L     15,=V(@PRINTF4)     address of routine
    BALR  14,15               call @PRINTF4
    EDCEPIL
ADDR_BLK DC    A(FMTSTR)       parameter address block with..
          DC    A(X'80000000'+INTVAL) ..high bit on the last address
FMTSTR  DC    C'Sample formatting string'
          DC    C' which includes an int -- %d --'
          DC    AL1(NEWLINE,NEWLINE)
          DC    C'and two newline characters'
          DC    AL1(NULL)

*
INTVAL  DC    F'222'           The integer value displayed
*
NULL    EQU   X'00'           C NULL character
NEWLINE EQU   X'15'           C \n character
END

```

---

Figure 49. Calling an intermediate C function from Assembler OS linkage

Finally in this example (CCNGCA5), the intermediate C routine calls a runtime library function, as shown in Figure 50.

---

```

/* this example demonstrates C/Assembler ILC */
/* part 3 of 3 (other files are CCNGCA2, CCNGCA4) */
/*****\
 * This routine is an interface between assembler code *
 * and the C/C++ library function printf(). *
 * OS linkage will not tolerate C-style variable length *
 * parameter lists, so this routine is specific to a *
 * formatting string and a single 4-byte substitution *
 * parameter. It's specified as an int here. *
 * This object will be named @PRINTF4. *
/*****/

#pragma linkage(_printf4,OS) /*function will be called from assembler*/

#include <stdio.h>

#pragma map(_printf4,"@PRINTF4")

int _printf4(char *str,int i) {
    return printf(str,i);    /* call runtime library function */
}

```

---

Figure 50. Intermediate C routine calling a runtime library function

---

## Calling runtime library routines from Assembler — C++ example

The following C++ example shows how to call library routines from assembler. There are three parts to this example.

The first part (CCNGCA1), shown in Figure 51 on page 257, is a trivial XL C/C++ routine that establishes the XL C/C++ runtime environment. It uses extern OS to indicate the OS linkage and calls the assembler routine.

---

```

// this example demonstrates C++/Assembler ILC
// part 1 of 3 (other files are CCNGCA2, CCNGCA3)

extern "OS" int CALLPRTF(void);

int main(void) {
    CALLPRTF();
}

```

---

*Figure 51. Establishing the XL C/C++ runtime environment*

The second part (CCNGCA2), shown in Figure 52, is the assembler routine. It calls an intermediate XL C/C++ routine that invokes a runtime library function.

---

```

* this example demonstrates ILC with Assembler (part 2 of 3)
CALLPRTF CSECT
    EDCPRLG
        LA    1,ADDR_BLK           parameter address block in r1
        L     15,=V(@PRINTF4)     address of routine
        BALR  14,15               call it
    EDCEPIL
ADDR_BLK DC    A(FMTSTR)           parameter address block with..
        DC    A(X'80000000'+INTVAL) ..high bit on the last address
FMTSTR  DC    C'Sample formatting string'
        DC    C' which includes an int -- %d --'
        DC    AL1(NEWLINE,NEWLINE)
        DC    C'and two newline characters'
        DC    AL1(NULL)
*
INTVAL  DC    F'222'              The integer value displayed
*
NULL    EQU   X'00'              C NULL character
NEWLINE EQU   X'15'              C \n character
END

```

---

*Figure 52. Calling an intermediate XL C/C++ function from Assembler using OS linkage*

The third part of the example (CCNGCA3), shown in Figure 53, is an intermediate XL C/C++ routine that calls a runtime library function.

---

```

// this example demonstrates XL C/C++/Assembler ILC
// part 3 of 3 (other files are CCNGCA1, CCNGCA2)

// This routine is an interface between assembler code
// and the runtime library function printf(). OS linkage
// will not tolerate C-style variable length parameter lists,
// so this routine is specific to a formatting string
// and a single 4-byte substitution parameter. It's
// specified as an int here.
#include <stdio.h>
#pragma map(_printf4,"@PRINTF4")

extern "OS" int _printf4(char *str,int i) {
    //function will be called from assembler
    return printf(str,i);    // call runtime library function
}

```

---

*Figure 53. Intermediate XL C/C++ routine calling a runtime library function*

---

## Register content at entry to a non-XPLINK ASM routine using OS linkage

When control is passed to an assembler routine that uses OS linkage, the contents of the registers are as follows:

- R0** Undefined.
- R1** Points to the parameter list. The parameter list consists of a vector of addresses, each of which points to an actual parameter. The address of the last parameter has its high-order bit set on, to indicate the end of the list.
- R2 to R11** Undefined.
- R12** Points to an internal control block. It can be used by the called routine but must be restored to its entry value if it calls a routine that expects z/OS Language Environment.
- R13** Points to the caller's DSA. Part of the DSA is used by EDCPRLG and EDCEPIL to save and restore registers. EDCPRLG can change R13 so that it points to the called routine's DSA from the caller's DSA.
- R14** The return address.
- R15** The address of the entry point being called.

---

## Register content at exit from a non-XPLINK ASM routine to z/OS XL C/C++

Registers have the following content when control returns to the point of call; all other floating point registers are undefined:

- R0** Undefined.
- R1** Undefined.
- R2 to R13** Must be restored to entry values. This is done by EDCEPIL and EDCPRLG.
- R14** Return address.
- R15** Return value for integer types (long int, short int, char) and pointer types. Otherwise set to 0.
- FP0** Returns value for float or double parameters.
- FP1** Returns value if long double is passed.
- FP2** Returns value if long double is passed.

**Note:** When in FLOAT(AFP) mode the callee must save and restore FPR's 8 through 15.

---

## Retaining the C environment using preinitialization

If an assembler routine called the same C or C++ program repeatedly, the creation and termination of the C/C++ environment for each call would be inefficient. The solution is to create the C/C++ environment only once by preinitializing the C or C++ program. The Language Environment preinitialization (CEEPIPI) services are the strategic form of preinitialization. For information on the Language

Environment preinitialization (CEEPIPI) services, see *z/OS Language Environment Programming Guide*. This section discusses the z/OS XL C preinitialization interface only for reasons of compatibility.

**Notes:**

1. This information pertains only to users of C programs.
2. XPLINK applications are not supported under Preinitialized Compatibility Interface (PICI) environments.
3. POSIX(ON) is not supported under PICI environments.
4. AMODE 64 applications are not supported under PICI environments.

If you are calling a C program multiple times from an assembler program, you can establish the C environment and then repeatedly invoke the C program using the already established C environment. You incur the overhead of initializing and terminating the C environment only once instead of every time you invoke the C program.

Because C detects programs that can be preinitialized dynamically during initialization, you do not have to recompile the program or link-edit it again.

To maintain the C environment, you start the program with the C entry CEESTART, and pass a special Extended Parameter List that indicates that the program is to be preinitialized.

When you use preinitialization, you are initializing the library yourself with the INIT call and terminating it yourself with the TERM call. In a non-preinitialized program, the library closes any files you left open and releases storage. It does not do this in a preinitialized program. Therefore, for every invocation of your preinitialized program, you must release all allocated resources as follows:

- Close all files that were opened
- Free all allocated storage
- Release all fetched modules

If you do not release all allocated resources, you will waste memory.

## **Setting up the interface for preinitializable programs**

The interface for preinitializing programs is shown in Figure 54 on page 260.

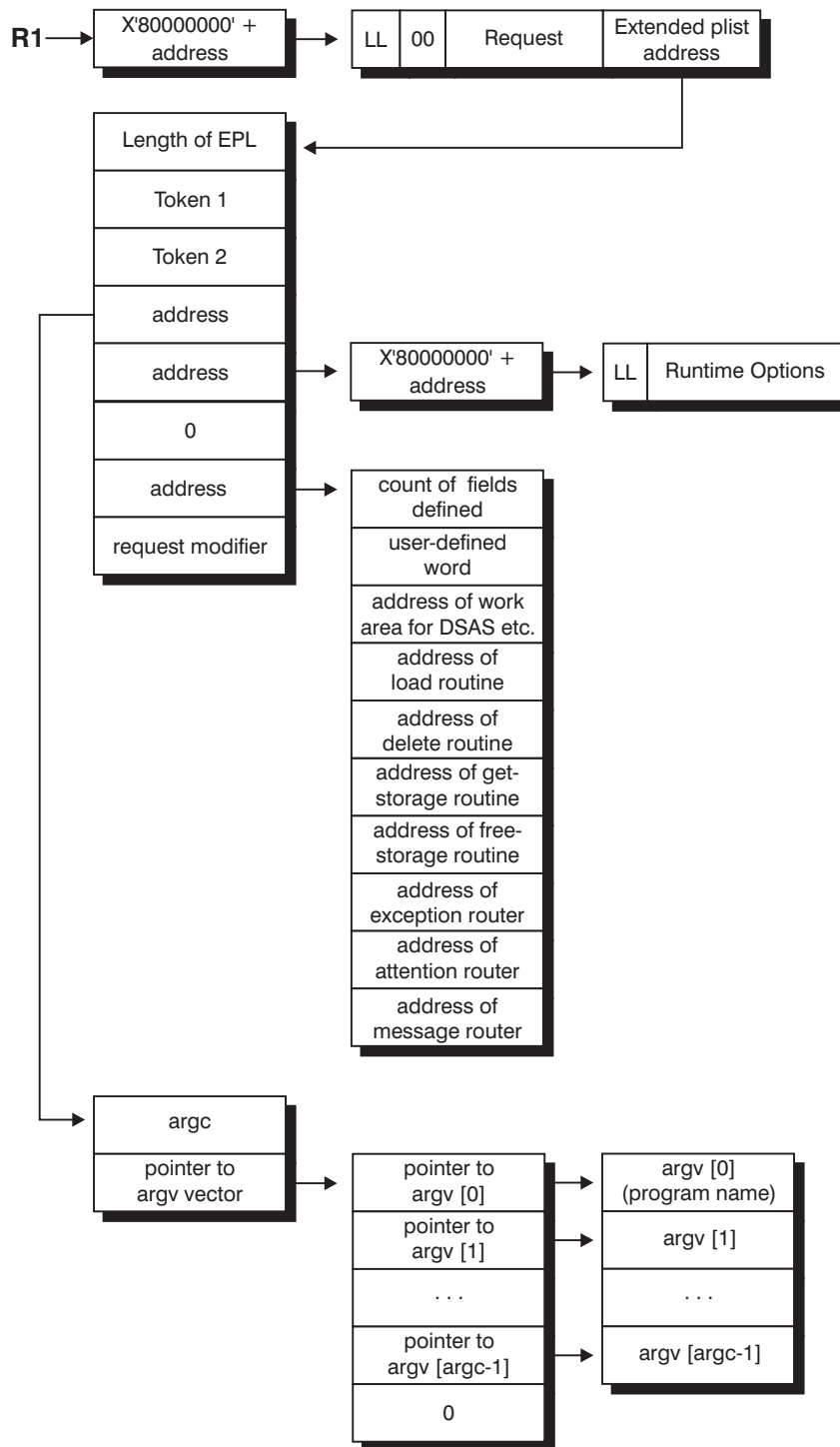

Figure 54. Interface for preinitializable programs

The LL field is a halfword containing the value of 16. The halfword that follows must contain 0 (zero).

The Request field is 8 characters that can contain the following values; no other values are valid.

**'INIT'**

Initializes the C environment and, returns two tokens that represent the

environment, but does not run the program. Token 1 and token 2 must both have the value of zero on an INIT call; otherwise, preinitialization fails.

You can initialize only one C environment at a time. However, you can make the sequence of calls to INIT, CALL, and TERM more than once.

#### **'CALL'**

Runs the C program using the environment established by the INIT request, and exits from the environment when the program completes. The CALL request uses the two tokens that were returned by the INIT request so that C can recognize the proper environment.

You can also initialize and call a C program by passing the CALL parameter with two zero tokens. The C program processes this request as an INIT followed by a CALL. You can still call the program repeatedly, but you should pass the two zero tokens only on the first call. Once the C environment is initialized, the values of the tokens are changed, and must not be modified on any subsequent calls.

Calling a C program other than the one used to initialize the C environment is not supported, especially if write-able static is needed by the program being called. This is because write-able static was allocated and initialized based upon the program used to initialize the C environment.

#### **'TERM'**

Terminates the C environment but does not run the program. The program used to terminate the C environment should be the same as the program used to initialize the C environment. Usage of a different program to terminate the C environment is unsupported.

#### **'EXECUTE'**

Performs INIT, CALL, and TERM in succession.

The Extended PLIST address field is a pointer to the Extended Parameter List (EPL). The EPL is a vector of fullwords that consists of:

##### **Length of extended parameter list**

The length includes the 4 bytes for the length field. Valid decimal values are 20, 28, and 32.

##### **First and second C environment tokens**

These tokens are automatically returned during initialization; or, you can use zeros for them when requesting a preinitialized CALL, and the effect is that both an INIT and a CALL are performed.

##### **Pointer to your program parameters**

The layout of the parameters is shown in Figure 54 on page 260, Interface for Preinitialization Programs. If no parameter is specified, use a fullword of zeros.

##### **Pointer to your runtime options**

To point to the character string of runtime options, refer to Figure 54 on page 260. The character string consists of a halfword LL field that contains the length of the list of runtime options, followed by the actual list of runtime options.

##### **Pointer to an alternative main**

This field is not supported in C. However, if you want to use the seventh or eighth fields, use a full word of zeros as a place holder.

##### **Pointer to the service vector**

If you want certain services (such as load and delete) to be carried out by



other code supplied by you (instead of, for example, by the LOAD and DELETE macros), use this field to point to the service vector. See Figure 54 on page 260.

### Request modifier code

When your request is INIT, CALL, or EXECUTE, you can specify any of the following request modifier codes:

- 0 Does not change the request.
- 1 Loads all common library modules as part of the preinitialized environment.
- 2 Loads all common and C library modules as part of the preinitialized environment.
- 3 Reinitializes the environment. If the environment is already established, frees all HEAP storage and any ISA overflow segments. Do not use this code if subsequent calls depend on storage that is still being allocated by previous calls.
- 4 Allows you to create more than one environment. The new environment is chained with existing request modifier 4 environments or a batch environment, where possible, so that C memory file sharing among the environments is possible. Details on chaining and C memory file sharing support are covered in "Multiple preinitialization compatibility interface C environments" on page 270.

The user-supplied service routine vector is not supported when you use request modifier value 4 in the extended parameter list. Do not code this if you are using the service routine vector. If you do, an abnormal end will occur.

- 5 Allows you to create more than one environment. The new environment is separated from other environments which may already exist. This environment does not support sharing of C memory files with other preinitialization compatibility interface environments.

When your request is TERM, you can specify either of the following request modifier codes:

- 0 Does not change the request.
- 1 Forces termination. Ends the C environment without any of the usual checks. Code this field only when you cannot request normal termination. You must ensure that the environment you are forcing to end is not in use.

The length you specify in the first field of the extended parameter list makes it known whether you have specified a request modifier code or not.

Runtime options are applied only at initialization and remain until termination. You must code PLIST(MVS) in the called C program in order for the preinitialization to work.

The options ARGPARSE|NOARGPARSE have no effect on preinitialized programs. The assembler program has to provide parameters in the form expected by the C program. Thus, if the C program is coded for the NOARGPARSE option, the argc should be set to 2, and parameters passed as a single string.

## Preinitializing a C program

Figure 55 on page 264 is a sample preinitialized C program that shows how to do the following:

- Establish the C environment using an INIT request
- Pass runtime parameters to the C initialization routine
- Set up a parameter to the C program
- Repeatedly call a C program using the CALL request
- Communicate from the C program to the driving program using a return code
- End the C program using the TERM request

The parameters it expects are the file name in `argv[1]` and the return code in `argv[2]`. The C program `printf()`s the value of the return code, writes a record to the file name, and decrements the value in return code.

The assembler program that drives the C program establishes the C environment and repeatedly invokes the C program, initially passing a value of 5 in the return code. When the return code set by the C program is zero, the assembler program terminates the C environment and exits.

Program CCNGCA6 (Figure 55 on page 264 ) **does not include** the logic that would verify the correctness of any of the invocations. Such logic is imperative for proper operations.

```

CCNGCA6 TITLE 'TESTING PREINITIALIZED C PROGRAMS'
***-----
***      this example shows how to preinitialize a C program
***      part 1 of 3 (other files are CCNGCA7 and CCNGCA8)
***      Function: Demonstrate the use of Preinitialized C programs
***      Requests used:  INIT, CALL, TERM
***      Parameters to C program: FILE_NAME, RUN_INDEX
***      Return from C Program: RUN_INDEX
***-----
CCNGCA6 CSECT
CCNGCA6 RMODE ANY
CCNGCA6 AMODE ANY
          EXTRN CEESTART          C Program Entry
          STM  R14,R12,12(R13)    Save registers
          BALR R3,0              Set base register
          USING *,R3             Establish addressability
          ST   R13,SVAR+4        Set back chain
          LA   R13,SVAR          Set this module's save area
***-----
***      Initialize
***-----
P_INIT  DS    0H
          MVC  P_RQ,INIT          Set INIT as the request
          LA   R1,PALIPTR        Load Parameter pointer
          L    R15,CEP           Load C Entry Point
          BALR R14,R15          Invoke C Program
***-----
***      The C environment has been established.
***      Parameters include RUN_INDEX which will be counted down
***      by the C program.  When the RUN_INDEX is zero, termination
***      will be requested.
***      The following code will set up C program parameters and
***      CALL request, invoke the C program and test for termination.
***-----
          LA   R1,PGPAPT          Pointer to C program parameters
          ST   R1,EP_PGPA        ... to extended parameter list
DO_CALL DS    0H
          MVC  P_RQ,CALL          set up CALL request
          LA   R1,PALIPTR        set parameter pointer
          L    R15,CEP           set entry point
          BALR R14,R15          invoke C program
          L    R0,RUN_INDEX      Test Return Code
          LTR  R0,R0
          BNZ  DO_CALL           Repeat CALL
***-----
***      C requested termination.
***      Set up TERM request and terminate the environment
***-----
DO_TERM DS    0H
          MVC  P_RQ,TERM          set up TERM request
          SR   R1,R1             mark no parameters
          ST   R1,EP_PGPA        set parameter pointer
          LA   R1,PALIPTR        set parameter pointer
          L    R15,CEP           set entry point
          BALR R14,R15          invoke termination

```

*Preinitializing a C program (CCNGCA6) (Part 1 of 3)*

*Figure 55. Preinitializing a C program (CCNGCA6)*

```

***-----
***      Return to system
***-----
XIT      DS      0H
          L       R13,4(13)
          LM      R14,R12,12(13)
          BR      R14
***-----
***      Constants and work areas
***-----
VARCON   DS      0D
PALIPT   DC      A(X'80000000'+PALI)  Address of Parameter list
CEP      DC      A(CEESTART)         Entry point address
***-----
PALI     DS      0F                    Parameter list
P_LG     DC      H'16'                Length of the list
          DC      H'0'                 Must be zero
P_RQ     DC      CL8' '                Request - INIT,CALL,TERM,EXECUTE
P_EP_PT  DC      A(EPALI)             Address of extended plist
***-----
EPALI    DS      0F                    Extended Parameter list
          DC      A(EP_LG)            Length of this list
EP_TCA   DC      A(0)                 First token
EP_PRV   DC      A(0)                 Second token
EP_PGPA  DC      A(PGPAPT)            Address of C program plist
EP_XOPT  DC      A(XOPTPT)            Address of runtime options
EP_LG    EQU     *-EPALI              Length of this list
***-----
***      C program plist in argc, argv format
***-----
PGPAPT   DC      F'3'                 Number of parameters (argc)
          DC      A(PGVTPT)            parameter vector pter (argv)
PGVTPT   DS      0A                    Parameter Vector
          DC      A(PGNM)              Program name pointer (argv1)
          DC      A(FILE_NAME)         File name pointer (argv2)
          DC      A(RUN_INDEX)         Run index pointer (argv3)
          DC      XL4'00000000'        NULL pointer
***-----
***      Runtime options
***-----
XOPTPT   DC      A(X'80000000'+XOPTLG) Runtime options pter
XOPTLG   DC      AL2(XOPTSQ)           Runtime option list length
XOPTS    DC      C'STACK(4K) RPTSTG(ON)' Runtime options list
XOPTSQ   EQU     *-XOPTS              Runtime options length
***-----
PGNM     DC      C'CCNGCA7',X'00'      C program name
FILE_NAME DC      C'PREINIT.DATA',X'00' File name for C program
RUN_INDEX DC      F'5',X'00'          changed by C Program
***-----
***      Request strings for preinitialization
***-----
INIT     DC      CL8'INIT'
CALL     DC      CL8'CALL'
TERM     DC      CL8'TERM'
EXEC     DC      CL8'EXECUTE'
***-----
***      Assembler program's register save area
***-----
SVAR     DC      18F'0'
          LTORG

```

*Preinitializing a C program (CCNGCA6) (Part 2 of 3)*

```

***-----
***      Register definitions
***-----
R0      EQU    0
R1      EQU    1
R2      EQU    2
R3      EQU    3
R4      EQU    4
R5      EQU    5
R6      EQU    6
R7      EQU    7
R8      EQU    8
R9      EQU    9
R10     EQU    10
R11     EQU    11
R12     EQU    12
R13     EQU    13
R14     EQU    14
R15     EQU    15
        END

```

### *Preinitializing a C program (CCNGCA6) (Part 3 of 3)*

Program CCNGCA7 (Figure 56) shows how to use the preinitializable program.

```

/* this example shows how to use a preinitializable program */
/* part 2 of 3 (other files are CCNGCA6 and CCNGCA8) */

#pragma runopts(PLIST(MVS))

#include <stdio.h>
#include <stdlib.h>

#define MAX_MSG 50
#define MAX_FNAME 8

typedef int (*f_ptr)(int, char*); /* pointer to function returning int*/

int main(int argc, char **argv)
{
    FILE *fp;                /* File to be written to */
    int *ptr_run;            /* Pointer to the "run index" */
    char *ffmsg;             /* a pointer to the "fetched function msg"*/
    char fname[MAX_FNAME+1]; /* name of the function to be fetched */
    int fetch_rc;            /* Return value of function invocation */
    f_ptr fetch_ptr;         /* Function pointer to fetched function */

    /* Get the pointer to the "run index" */
    ptr_run = (int *)argv[2];

    if ((fp = fopen(argv[1], "a")) == NULL)
    {
        printf("Cannot open file %s\n", argv[1]);
        *ptr_run = 0;         /* Set to zero so it won't be called again */
        return(0);           /* Return to Assembler program */
    }
}

```

### *Using the preinitializable program (CCNGCA7) (Part 1 of 2)*

Figure 56. Using the preinitializable program (CCNGCA7)

```

/* Write the record to the file */
fprintf(fp,"Run index was %d.\n",*ptr_run);

/* Allocate the message returned from the fetched function */
if (( fmsg=(char *)malloc(MAX_MSG + 1)) == NULL )
    printf("ERROR -- malloc returned NULL\n");

/* fetch the function */
fetch_ptr = (f_ptr) fetch("MYFUNC");
if (fetch_ptr == NULL)
    printf("ERROR - Fetch returned a null pointer\n");

/* execute the function */
fetch_rc = fetch_ptr(*ptr_run, fmsg); /* Write the function msg to file */
fprintf(fp,"%s\n",fmsg);

/* Tell the user the value of the "run index" */
printf("Run index was %d.\n",*ptr_run);

/* Decrement the "run index" */
(*ptr_run)--;

/* Remember to close all opened files */
fclose(fp);

/* Remember to free all allocated storage */
free( fname );

/* Remember to release all fetched modules */
release((void*())fetch_ptr);

/* Return to Assembler program */
return(0);
}

```

### *Using the preinitializable program (CCNGCA7) (Part 2 of 2)*

Finally, Figure 57 shows sample program CCNGCA8.

---

```

/* this example shows how to use a preinitializable program */
/* part 3 of 3 (other files are CCNGCA6 & CCNGCA7) */

#include <string.h>

#pragma linkage(fetchable, fetched)

int fetched(int run_index, char *ffmsg) {
    sprintf(ffmsg,"Welcome to myfunc: Run index was %d.",run_index);
    return(0);
}

```

---

*Figure 57. Using the preinitializable program (CCNGCA8)*

## **Return codes**

Preinitialized programs do not put their return codes in R15. If the address of the return code is required, specify a parameter. Figure 55 on page 264 shows how you can use the RUN\_INDEX parameter to evaluate the address of a return code.

### **User exits in preinitializable programs**

C invokes user exits when initialization and termination are actually performed. That is, the initialization user exit is invoked during the INIT request or the CALL with the zero token request. Similarly, the termination user exit is called only during the TERM request.

### **Runtime options**

If runtime options are specified in the assembler program, the C program must be compiled with EXECOPS in effect. EXECOPS is the default.

### **Calling a preinitializable program**

Figure 58 on page 269 shows sample JCL to run a preinitializable program in the z/OS environment.

```

//youridA JOB
//*
// SET LIB='CEE'
// SET CMP='CBC'
//*
//PROCLIB JCLLIB ORDER=(&CMP..SCCNPRC)
//*-----
//*          ASSEMBLE THE DRIVING ASSEMBLER PROGRAM
//*-----
//HLASM EXEC PGM=ASMA90,
//      PARM='NODECK,OBJECT,LIST,ALIGN'
//SYSPRINT DD SYSOUT=*
//SYSLIB DD DSN=SYS1.MACLIB,DISP=SHR
//SYSUT1 DD UNIT=VIO,DISP=(NEW,DELETE),SPACE=(32000,(30,30))
//SYSUT2 DD UNIT=VIO,DISP=(NEW,DELETE),SPACE=(32000,(30,30))
//SYSUT3 DD UNIT=VIO,DISP=(NEW,DELETE),SPACE=(32000,(30,30))
//SYSPUNCH DD DUMMY
//SYSLIN DD DSN=&&OBJECT(ASSEM),SPACE=(80,(400,400,5)),
//      DISP=(,PASS),UNIT=VIO,DCB=(RECFM=FB,LRECL=80,BLKSIZE=3200)
//SYSIN DD DSN=yourid.CCNGCA6.ASM,DISP=SHR
//*-----
//*          COMPILER THE MAIN C PROGRAM
//*-----
//COMP EXEC EDCC,INFILE='yourid.CCNGCA7.C',
//      OUTFILE='&&OBJECT(CMAIN),DISP=(OLD,PASS)',
//      CPARM='NOOPT,NOSEQ,NOMAR',
//      LIBPRFX=&LIB.,LNGPRFX=&CMP.
//*-----
//*          COMPILER AND LINK THE FETCHED C PROGRAM
//*-----
//CMLK EXEC EDCL,INFILE='yourid.CCNGCA8.C',
//      CPARM='NOOPT,NOSEQ,NOMAR',
//      LIBPRFX=&LIB.,LNGPRFX=&CMP.
//LKED.SYSLMOD DD DSN=&&LOAD(MYFUNC),DISP=(,PASS),
//      UNIT=VIO,SPACE=(TRK,(1,1,5))
//*-----
//* LINK THE ASSEMBLER DRIVER AND MAIN C PROGRAM
//*-----
//LKED EXEC PGM=IEWL,PARM='MAP,XREF,LIST',
//      COND=((4,LT,HLASM),(4,LT,COMP.COMPILE),(4,LT,CMLK.LKED))
//OBJECT DD DSN=&&OBJECT,DISP=(OLD,PASS)
//SYSLIN DD *
//      INCLUDE OBJECT(ASSEM)
//      INCLUDE OBJECT(CMAIN)
//      ENTRY CCNGCA6
//*
//SYSLIB DD DISP=SHR,DSN=&LIB..SCEELKED
//SYSPRINT DD SYSOUT=*
//SYSUT1 DD DSN=&&SYSUT1,UNIT=VIO,SPACE=(CYL,(1,1))
//SYSLMOD DD DSN=&&LOAD(PREINIT),DISP=(OLD,PASS)
//*-----

```

*JCL for running a preinitializable C program (Part 1 of 2)*

Figure 58. JCL for running a preinitializable C program



```

/*-----
/* RUN
/*-----
//GO      EXEC  PGM=*.LKED.SYSLMOD,
//          COND=(4,LT,LKED)
//STEPLIB DD  DISP=OLD,DSN=&&LOAD
//          DD  DISP=SHR,DSN=&LIB..SCEERUN
//STDIN   DD  SYSOUT=*
//STDOUT  DD  SYSOUT=*
//STDERR  DD  SYSOUT=*
//SYSPRINT DD SYSOUT=*
//SYSUDUMP DD SYSOUT=*

```

*JCL for running a preinitializable C program (Part 2 of 2)*

## Multiple preinitialization compatibility interface C environments

To establish multiple Preinitialized Compatibility Interface (PICI) environments, you must specify either request modifier 4 or request modifier 5 in the extended parameter list (EPL) at environment initialization.

### Request modifier 4 environment characteristics

Use request modifier 4 to establish an environment which is tolerant of an existing environment. When a request modifier 4 environment is dormant, it is immune to creation or termination of other environments.

Environments created using request modifier 4 normally intend to share C memory files, but it is not required for the application to take advantage of this support. A new environment of this type is chained to the currently active environment that supports chaining, or it will set up a dummy environment which supports chaining. This allows for C memory files to be shared.

The sharing of C memory files across request modifier 4 environments is only supported within the boundary of the application. There are really only two types of applications where request modifier 4 environments are involved. The first type is a set of pure request modifier 4 environments; there are no batch environments. The second type allows a single batch environment. In the second type, the batch environment must be the first initialized and the last terminated.

If starting with non z/OS Language Environment enabled assembler, the first request modifier 4 environment creates a dummy environment (z/OS Language Environment region-level control blocks) in addition to its own. The dummy environment remains pointed to by the TCB when the initialization is complete. The next initialization using request modifier 4 recognizes an existing environment that supports chaining and the new environment will be chained. This permits the two environments to share C memory files. Request modifier 4 environments in this model can be initialized and terminated in any order.

If starting with a batch environment (for example, COBOL, PL/I or C), which supports chaining by default, and during execution within that environment a call is made to an assembler routine which initializes a request modifier 4 environment, the z/OS Language Environment batch environment is recognized and the new environment will be chained. This allows an initial batch environment to share C memory files with the request modifier 4 environment. Request modifier 4

environments in this model can be initialized and terminated in any order, but all request modifier environments must be terminated before the batch environment is terminated.

**Notes:**

1. When a batch environment is chained with request modifier 4 environments, the z/OS Language Environment batch environment must be the first environment that is initialized and the last environment that is terminated. All request modifier 4 environments initialized within the scope of a batch environment must be terminated prior to exiting the batch environment. Failure to do so will leave the request modifier 4 environments in a state such that attempted call or termination requests will result in unpredictable behavior.
2. Initialization of a request modifier 4 environment while running in a non-sharable environment, such as a request modifier 5 environment, causes the new request modifier 4 environment to be non-sharable.

**Sharing C memory files with request modifier 4 environments:** You can use request modifier 4 to create multiple Preinitialized Compatibility Interface (PICI) C environments. When you create a new request modifier 4 environment, it is chained under certain circumstances to the current environment.

The following list identifies the specific features that are or are not supported in the multiple PICI C environment scenario:

- C memory files will be shared across all C environments (as long as at least one C environment exists) that are on the chain. This includes all PICI C environments that are initialized and possibly an initial batch C environment.
- Because the PICI C environments are chained, initialization and termination of these PICI C environments can be performed in any order. The chaining also requires that the C runtime library treat each PICI C environment as equal. In C runtime library terms, each PICI C environment is considered a root enclave (depth=0).
- Because there can be multiple C root enclaves, sharing of C standard streams across the C root enclaves exhibits a special behavior. When a C standard stream is referenced for the first time, its definition is made available to each of the C root enclaves.
- C standard streams are inherited across the `system()` call boundary. When a PICI C environment is initialized from a nested enclave, it does not inherit the standard streams of the nested enclave. Instead, it shares the C standard stream definitions at the root level.
- C regular (nonmemory, nonstandard stream) files are also shared across the PICI C environments.
- Nested C enclaves are created using the `system()` call. The depth is relative to the root enclave that owns the `system()` call chain. You can have two C enclaves, other than the C root enclaves, with the same depth. You can do this by calling one of the PICI C environments from a nested enclave and then using `system()` in the PICI C environment.
- C regular (nonmemory, nonstandard stream) files opened in a `system()` call enclave are closed automatically when the enclave ends.
- C regular (nonmemory, nonstandard stream) files that are opened in a PICI C environment root enclave are not closed automatically until the PICI C environment ends. Before returning to the caller, you should close streams that are opened by the PICI C environment. If you do not, undefined behavior can occur.

- C memory files are not removed until the last PICI C environment is ended.
- The `clrmemf()` function will only remove C memory files created within the scope of the C root enclave from which the function is called.
- When a PICI C environment is called, flushing of open streams is not performed automatically as it is when you use the `system()` call.
- This function is not supported under CICS.
- This function is not supported under System Programming C (SP C).
- Use of `POSIX(ON)` is not supported with this feature.

### **Request modifier 5 environment characteristics**

Use request modifier 5 to establish an environment that is tolerant of an existing environment. When a request modifier 5 environment is dormant, it is immune to creation or termination of other environments. Request modifier 5 environments cannot share C memory files with other environments. Each environment of this type is created as a separate entity, not connected to any other environment. Request modifier 5 environments can be initialized and terminated in any order.

### **Restrictions on using batch environments with preinitialization compatibility interface C environments**

If a batch environment is to participate in C memory file sharing, such as with a request modifier 4 environment, then the batch environment must be the first environment created and the last one terminated. All PICI environments initialized within the scope of the batch environment must be terminated before the batch environment is terminated. This is required because the PICI environment shares control blocks that belong to the batch environment. If the batch environment is terminated, storage for those control blocks is released. Attempts to use or terminate a PICI environment after the batch environment has terminated will result in unpredictable behavior.

### **Behaviors when mixing request modifier 4 and request modifier 5**

While running in a request modifier 5 environment, initializing another environment with request modifier 4 creates a new environment that is separated from the rest. The new environment will not be able to share C memory files with any other request modifier 4 environment that may already exist.

While running in a request modifier 4 environment, initialization of a request modifier 5 environment creates a new environment that is separated from the rest. If the new request modifier 5 environment is within the scope of a batch environment, this new environment does not need to be terminated before the batch environment is terminated.

## **Using the service vector and associated routines**

The service vector is a list of addresses of user-supplied service routines. The interface requirements for each of the service routines that you can supply, including sample routines for some of the services, are provided in the following sections.

### **Using the service vector**

If you want certain services like load and delete to be carried out by other programs supplied by you (instead of, for example, by the `LOAD` and `DELETE` macros), you must place the address of your service vector in the seventh fullword field of the extended parameter list. Define the service vector according to the pattern shown in the following example. Although you need not use labels identical to these, you must use the same order. The address of your load routine

is "fourth", and the address of your free-storage routine is "seventh".

SRV_COUNT	DS F	Count of fields defined
SRV_USER_WORD	DS F	User-defined word
SRV_WORKAREA	DS A	Addr of work area for DSAs etc
SRV_LOAD	DS A	Addr of load routine
SRV_DELETE	DS A	Addr of delete routine
SRV_GETSTOR	DS A	Addr of get-storage routine
SRV_FREESTOR	DS A	Addr of free-storage routine
SRV_EXCEP_RTR	DS A	Addr of exception router
SRV_ATTN_RTR	DS A	Addr of attention router
SRV_MSG_RTR	DS A	Addr of message router

Some other constraints apply:

- You cannot omit any fields on the template that precede the last one you specify from your definition of the service vector. You can supply zeros for the ones you want ignored.
- The field count does not count itself. The maximum value is, therefore, 9.
- You must specify an address in the work area field if you specify addresses in any of the subsequent fields.
- This work area must begin on a doubleword boundary and start with a fullword that specifies its length. This length must be at least 256 bytes.
- For the load and delete routines, you cannot specify one of the pair without the other; if one of these two fields contains a value of zero, the other is automatically ignored. The same is true for the get-storage and free-storage pair.
- If you specify the get-storage and free-storage services, you must also specify the load and delete services.

You must supply any service routines pointed to in your service vector. When called, these service routines require the following:

- Register 13 points to a standard 18–fullword save area.
- Register 1 points to a list of addresses of parameters available to the routine.
- The third parameter in the list must be the address of the user word you specified in the second field of the service vector.

The parameters available to each routine, and the return and reason codes that each routine uses, are shown in the following section. The parameter addresses are passed in the same order in which the parameters are listed.

### Load service routine

The load routine loads named modules. The LOAD macro usually provides this service. The parameters passed to the load routine are shown in Table 37.

Table 37. Load service routine parameters

Parameter	ASM Attributes	Type
Address of module name	DS A	Input
Length of name	DS F	Input
User word	DS A	Input
(Reserved field)	DS F	Input
Address of load point	DS A	Output
Size of module	DS F	Output
Return code	DS F	Output

Table 37. Load service routine parameters (continued)

Parameter	ASM Attributes	Type
Reason code	DS F	Output

The name length must not be zero. You can ignore the reserved field. It will contain zeros. The load routine can set the following return/reason codes:

- 0/0     successful
- 4/4     unsuccessful — module loaded above line when in AMODE 24
- 8/4     unsuccessful — load failed
- 16/4    unrecoverable error occurred

### Delete service routine

The delete routine deletes named modules. The DELETE macro usually provides this service. The parameters passed to the delete routine are shown in Table 38.

Table 38. Delete service routine parameters

Parameter	ASM Attributes	Type
Address of module name	DS A	Input
Length of name	DS F	Input
User word	DS A	Input
(Reserved field)	DS F	Input
Return code	DS F	Output
Reason code	DS F	Output

The name length must not be zero. You can ignore the reserved field. It will contain zeros. Every delete action must have a corresponding load action, and the task that does the load must also do the delete. Counts of deletes and loads performed must be maintained by the service routines.

The delete routine can set the following return/reason codes:

- 0/0     successful
- 8/4     unsuccessful — delete failed
- 16/4    unrecoverable error occurred

### Get-storage service routine

The get-storage routine obtains storage. The GETMAIN macro usually provides this service. The parameters passed to the get-storage routine are shown in Table 39.

Table 39. Get-storage service routine parameters

Parameter	ASM Attributes	Type
Amount desired	DS F	Input
Subpool number	DS F	Input
User word	DS A	Input
Flags	DS F	Input
Address of obtained storage	DS A	Output
Amount obtained	DS F	Output

Table 39. Get-storage service routine parameters (continued)

Parameter	ASM Attributes	Type
Return code	DS F	Output
Reason code	DS F	Output

The get-storage routine can set the following return/reason codes:

- 0/0      successful
- 4/4      unsuccessful — the storage could not be obtained
- 16/4     unrecoverable error occurred.

**Note:** If this routine does not preserve the high registers across the call, Language Environment may not preserve the high registers of the assembler driver program across the call to Language Environment.

### Free-storage service routine

The free-storage routine frees storage. The FREEMAIN macro usually provides this service. The parameters passed to the free-storage routine are shown in Table 40.

Table 40. Free-storage service routine parameters

Parameter	ASM Attributes	Type
Amount to be freed	DS F	Input
Subpool number	DS F	Input
User word	DS A	Input
Address of storage	DS A	Input
Return code	DS F	Output
Reason code	DS F	Output

The free-storage routine can set the following return/reason codes:

- 0/0      successful
- 16/4     unrecoverable error occurred

**Note:** If this routine does not preserve the high registers across the call, Language Environment may not preserve the high registers of the assembler driver program across the call to Language Environment.

### Exception router service routine

The exception router traps and routes exceptions. The ESTAE and ESPIE macros usually provide this service. The parameters passed to the exception router are shown in Table 41.

Table 41. Exception router service routine parameters

Parameter	ASM Attributes	Type
Address of exception handler	DS A	Input
Environment token	DS A	Input
User word	DS A	Input
Abend flags	DS F	Input
Check flags	DS F	Input

Table 41. Exception router service routine parameters (continued)

Parameter	ASM Attributes	Type
Return code	DS F	Output
Reason code	DS F	Output

During initialization, if the ESTAE and/or ESPIE options are in effect, the common library puts the address of the common library exception handler in the first field of the above parameter list, and sets the environment token field to a value that is passed on to the exception handler. It also sets abend and check flags as appropriate, and then calls your exception router to establish an exception handler.

The meaning of the bits in the abend flags are given by the following structure:

```

struct {
    struct {
        unsigned short abends    : 1, /*control for system abends*/
                       reserved : 15;
    } system;
    struct {
        unsigned short abends    : 1, /*control for user abends*/
                       reserved : 15;
    } user;
} abendflags;

```

The meaning of the bits in the check flags are given by the following structure:

```

struct {
    struct {
        unsigned short reserved      : 1,
                       operation     : 1,
                       privileged_operation : 1,
                       execute       : 1,
                       protection    : 1,
                       addressing     : 1,
                       specification  : 1,
                       data          : 1,
                       fixed_overflow : 1,
                       fixed_divide  : 1,
                       decimal_overflow : 1,
                       decimal_divide : 1,
                       exponent_overflow : 1,
                       exponent_divide : 1,
                       significance  : 1,
                       float_divide  : 1;
    } type;
    unsigned short reserved;
} checkflags;

```

The exception router service routine can set the following return/reason codes:

- 0/0     successful
- 4/4     unsuccessful — the exit could not be (de)-established
- 16/4    unrecoverable error occurred

**Notes:**

1. If the passed-in SDWA from the PIC1 exception router service routine to the common library exception handler does not contain valid high registers, the

"HR\_VALID" flag bit in the Machine State "FLAGS" field will be off, indicating that the saved high registers are not valid.

2. If a nested enclave ends because of an unhandled condition and a 4094-40 ABEND is declared, the high registers may not be valid in the Machine State that contains information about the 4094-40 ABEND.
3. If registers in the passed-in SDWA at the time of interrupt (in the SDWAGRSV field) are not appropriate or recognizable, and Language Environment saves the registers from the SDWASRSV field in the Machine State instead, the high registers may not be valid in the Machine State.

### Attention router service routine

The attention router traps and routes attention interrupts. The STAX macro usually provides this service. The parameters passed to the attention router are shown in Table 42.

Table 42. Attention router service routine parameters

Parameter	ASM Attributes	Type
Address of attention router	DS A	Input
Environmental token	DS A	Input
User word	DS A	Input
Return code	DS F	Output
Reason code	DS F	Output

The attention router routine can set the following return/reason codes:

- 0/0      successful
- 4/4      unsuccessful — the exit could not be (de)-established
- 16/4     unrecoverable error occurred

When an attention interrupt occurs, your attention router must invoke the attention handler. Use the address in the attention handler field passing the parameters shown in Table 43.

Table 43. Attention handler parameters

Parameter	ASM Attributes	Type
Environment token	DS A	Input
Return code	DS F	Output
Reason code	DS F	Output

The return/reason codes upon return from the attention handler are:

- 0/0      The attention interrupt has been or will be handled

If an attention interrupt occurs in the attention handler or when an attention handler is not started, your attention router should ignore the attention interrupt.

### Message router service routine

The message router routes messages written by the runtime library. These messages are usually written to the Language Environment Message File. The parameters passed to the message router are shown in Table 44 on page 278.



Table 44. Message router service routine parameters

Parameter	ASM Attributes	Type
Address of message	DS A	Input
Message length in bytes	DS F	Input
User word	DS A	Input
Line length	DS F	Input
Return code	DS F	Output
Reason code	DS F	Output

If the address of the message is zero, your message router is expected to return the size of the line to which messages are written (in the length field). The length field allows messages to be formatted correctly, for example, broken at blanks. The message routine must use the following return/reason codes:

- 0/0      successful
- 16/4    unrecoverable error occurred

---

## Part 4. Coding: Advanced Topics

This part contains the following coding topics:

- Chapter 21, "Building and using Dynamic Link Libraries (DLLs)," on page 281
- Chapter 22, "Building complex DLLs," on page 301
- Chapter 23, "z/OS 64-bit environment," on page 325
- Chapter 24, "Using threads in z/OS UNIX applications," on page 353
- Chapter 25, "Reentrancy in z/OS XL C/C++," on page 369
- Chapter 26, "Using decimal data types in C," on page 377
- Chapter 27, "IEEE Floating-Point," on page 397
- Chapter 28, "Handling error conditions, exceptions, and signals," on page 403
- Chapter 29, "Network communications under UNIX System Services," on page 425
- Chapter 30, "Interprocess communication using z/OS UNIX," on page 453
- Chapter 31, "Using templates in C++ programs," on page 457
- Chapter 32, "Using environment variables," on page 467
- Chapter 33, "Using hardware built-in functions," on page 505
- Chapter 36, "ANSI C/C++ 98 applications and C99," on page 677
- Chapter 37, "Writing applications for Single UNIX Specification, Version 3," on page 681
- Chapter 38, "Saved compile-time options information," on page 687



---

## Chapter 21. Building and using Dynamic Link Libraries (DLLs)

A dynamic link library (DLL) is a collection of one or more functions or variables in an executable module that is executable or accessible from a separate application module. In an application without DLLs, all external function and variable references are resolved statically at bind time. In a DLL application, external function and variable references are resolved dynamically at run time.

This chapter defines DLL concepts and shows how to build simple DLLs. Chapter 22, “Building complex DLLs,” on page 301 shows how to build complex DLLs and discusses some of the compatibility issues of DLLs.

There are two types of DLLs: simple and complex. A simple DLL contains only DLL code in which special code sequences are generated by the compiler for referencing functions and external variables, and using function pointers. With these code sequences, a DLL application can reference imported functions and imported variables from a DLL as easily as it can non-imported ones.

A complex DLL contains mixed code, that is, some DLL code and some non-DLL code. A typical complex DLL would contain some C++ code, which is always DLL code, and some C object modules compiled with the NODLL compiler option bound together.

The object code generated by the z/OS XL C++ compiler is always DLL code. Also, the object code generated by the z/OS XL C compiler with either the DLL compiler option or the XPLINK compiler option is DLL code. Other types of object code are non-DLL code. For more information about compiler options for DLLs, see the *z/OS XL C/C++ User's Guide*.

XPLINK compiled code and non-XPLINK compiled code cannot be statically mixed (with the exception of OS\_UPSTACK and OS\_NOSTACK (or OS31\_NOSTACK) linkages). The XPLINK compiled code can only be bound together with other XPLINK-compiled code. You can mix non-XPLINK compiled DLLs with XPLINK compiled DLLs (the same is true for routines which you load with `fetch()`). The z/OS XL C++ runtime library manages the transitions between the two different linkage styles across the DLL and `fetch()` boundaries.

### Notes:

1. There is inherent performance degradation when the z/OS XL C++ runtime library transitions across these boundaries. In order for your application to perform well, these transitions should be made infrequently. When using XPLINK, recompile all parts of the application with the XPLINK compiler option wherever possible.
2. As of z/OS V1R9, all support for the C/C++ IBM Open Class<sup>®</sup> Library is removed. For new code and enhancements to existing applications, the Standard C++ Library should be used.

---

## Support for DLLs

DLL support is available for applications running under the following systems:

- z/OS batch
- CICS
- IMS
- TSO
- z/OS UNIX

It is not available for applications running under SPC, CSP or MTF.

**Note:** All potential DLL executable modules are registered in the CICS PPT control table in the CICS environment and are invoked at run time.

---

## DLL concepts and terms

Table 45 summarizes important concepts and terminology about DLLs.

*Table 45. Summary of DLL concepts and terms*

Term	Definition
Application	All the code executed from the time an executable program module is invoked until that program, and any programs it directly or indirectly calls, is terminated.
DLL	An executable module that exports functions, variable definitions, or both, to other DLLs or DLL applications.
DLL application	An application that references imported functions, imported variables, or both, from other DLLs.
DLL code	Object code resulting when C source code is compiled with the DLL or XPLINK compiler options. C++ code is always DLL code.
Executable program (or executable module)	A file that can be loaded and executed on the computer. z/OS supports two types: <b>Load module</b> An executable residing in a PDS. <b>Program object</b> An executable residing in a PDSE or in the UNIX file system.
Exported functions or variables	Functions or variables that are defined in one executable module and can be referenced from another executable module. When an exported function or variable is referenced within the executable module that defines it, the exported function or variable is also non-imported.
Function descriptor	An internal control block containing information needed by compiled code to call a function.
Imported functions and variables	Functions and variables that are not defined in the executable module where the reference is made, but are defined in a referenced DLL.
Non-imported functions and variables	Functions and variables that are defined in the same executable module where a reference to them is made.
Object code (or object module)	A file output from a compiler after processing a source code module, which can subsequently be used to build an executable program module.
Source code (or source module)	A file containing a program written in a programming language.

Table 45. Summary of DLL concepts and terms (continued)

Term	Definition
Variable descriptor	An internal control block containing information about the variable needed by compiled code.
Writable Static Area (WSA)	An area of memory that is modifiable during program execution. Typically, this area contains global variables and function and variable descriptors for DLLs.
XPLINK application	An application that is made up of C and/or C++ object modules that were compiled with the XPLINK compiler option. XPLINK applications are always DLL applications. Since the C/C++ runtime library for XPLINK is packaged as a DLL, any XPLINK executable module that calls a C/C++ runtime library is also importing from a DLL.
XPLINK code	Object code resulting when C or C++ source code is compiled with the XPLINK compiler option. XPLINK code is always DLL code.

## Loading a DLL

A DLL is loaded implicitly when an application references an imported variable or calls an imported function. DLLs can be explicitly loaded by calling `dllload()` or `dlopen()`. Due to optimizations performed, the DLL implicit load point may be moved and the DLL will be loaded only if the actual reference occurs.

### Loading a DLL implicitly

When an application uses functions or variables defined in a DLL, the compiled code loads the DLL. This implicit load is transparent to the application. The load establishes the required references to functions and variables in the DLL by updating the control information contained in function and variable descriptors.

If the DLL contains static classes, constructors are run when the DLL is loaded. This loading may occur before `main()`; in this case, the corresponding destructors are run once when `main()` returns.

To implicitly load a DLL, do one of the following:

1. Statically initialize a variable pointer to the address of an exported DLL variable.
2. Reference a function pointer that points to an exported function.
3. Call an exported function.
4. Reference (use, modify, or take the address of) an exported variable.
5. Call through a function pointer that points to an exported function.

In the first situation, the DLL is loaded before `main()` is invoked, and if the DLL contains C++ code, constructors are run before `main()` is invoked. In the other situations, the DLL loading may be delayed until the time of the implicit call, although optimization may move this load earlier.

If the DLL application references (imports) an exported DLL variable, that DLL may be implicitly loaded before that DLL application is invoked (not necessarily before `main()` is invoked). With XPLINK, the DLL will always be implicitly loaded before invoking the DLL application that references (imports) a DLL variable or takes the address of a DLL function.

**Note:** When a DLL is loaded, its writable static is initialized. If the DLL load module contains C++ code, static constructors are run once at initial load time, and static destructors are run once at program termination. Static destructors are run in the reverse order of the static constructors.

## Loading a DLL explicitly

The use of DLLs can also be explicitly controlled by the application code at the source level. The application uses explicit source-level calls to one or more runtime services to connect the reference to the definition. The connections for the reference and the definition are made at run time.

The DLL application writer can explicitly call the following runtime services:

- `dllload()`, which loads the DLL and returns a handle to be used in future references to this DLL
- `dllqueryfn()`, which obtains a pointer to a DLL function
- `dllqueryvar()`, which obtains a pointer to a DLL variable
- `dllfree()`, which frees a DLL loaded with `dllload()`

The following runtime services are also available as part of the Single UNIX Specification, Version 3:

- `dlopen()`, which loads the DLL and returns a handle to be used in future references to this DLL
- `dlsym()`, which obtains a pointer to an exported function or exported variable
- `dlclose()`, which frees a DLL that was loaded with `dlopen()`
- `dlerror()`, which returns information about the last DLL failure on this thread that occurred in one of the `dlopen()` family of functions

While you can use both families of explicit DLL services in a single application, you cannot mix usage across those families. So a handle returned by `dllload()` can only be used with `dllqueryfn()`, `dllqueryvar()`, or `dllfree()`. And a handle returned by `dlopen()` can only be used with `dlsym()` and `dlclose()`.

Because the `dlopen()` family of functions is part of the Single UNIX Specification, Version 3, it should be used in new applications whenever cross-platform portability is a concern.

For more information about the runtime services, see *z/OS XL C/C++ Runtime Library Reference*.

To explicitly call a DLL in your application:

- Determine the names of the exported functions and variables that you want to use. You can get this information from the DLL provider's documentation or by looking at the definition side-deck file that came with the DLL. A definition side-deck is a directive file that contains an `IMPORT` control statement for each function and variable exported by that DLL.
- If you are using the `dllload()` family of functions, include the DLL header file `<dll.h>` in your application. If you are using the `dlopen()` family of functions, include the DLL header file `<dlfcn.h>` in your application.
- Compile your source as usual.
- Bind your object with the binder using the same `AMODE` value as the DLL.

**Note:** You do not need to bind with the definition side-deck if you are calling the DLL explicitly with the runtime services, since there are no references from the source code to function or variable names in the DLL, for the binder to resolve. Therefore the DLL will not be loaded until you explicitly load it with the `dllload()` or `dlopen()` runtime service.

### Examples of explicit use of a DLL in an application

The following examples show explicit use of a DLL in an application. The first example in Figure 59 uses the `dllload()` family of functions.

```
#include <dll.h>
#include <stdio.h>
#include <string.h>

#ifdef __cplusplus
extern "C" {
#endif

    typedef int (DLL_FN)(void);

#ifdef __cplusplus
}
#endif

#define FUNCTION        "FUNCTION"
#define VARIABLE       "VARIABLE"

static void Syntax(const char* progName) {
    fprintf(stderr, "Syntax: %s <DLL-name> <type> <identifier>\n"
        " where\n"
        " <DLL-name> is the DLL to load,\n"
        " <type> can be one of FUNCTION or VARIABLE\n"
        " and <identifier> is the function or variable\n"
        " to reference\n", progName);
    return;
}

main(int argc, char* argv[]) {
    int value;
    int* varPtr;
    char* dll;
    char* type;
    char* id;
    dllhandle* dllHandle;

    if (argc != 4) {
        Syntax(argv[0]);
        return(4);
    }
    dll = argv[1];
    type = argv[2];
    id = argv[3];

    dllHandle = dllload(dll);
    if (dllHandle == NULL) {
        perror("DLL-Load");
        fprintf(stderr, "Load of DLL %s failed\n", dll);
        return(8);
    }
}
```

*Explicit use of a DLL in an application using the `dllload()` family of functions (Part 1 of 2)*

*Figure 59. Explicit use of a DLL in an application using the `dllload()` family of functions*



```

if (strcmp(type, FUNCTION)) {
    if (strcmp(type, VARIABLE)) {
        fprintf(stderr,
            "Type specified was not " FUNCTION " or " VARIABLE "\n");
        Syntax(argv[0]);
        return(8);
    }
    /*
     * variable request, so get address of variable
     */
    varPtr = (int*)(dllqueryvar(dllHandle, id));
    if (varPtr == NULL) {
        perror("DLL-Query-Var");
        fprintf(stderr, "Variable %s not exported from %s\n", id, dll);
        return(8);
    }
    value = *varPtr;
    printf("Variable %s has a value of %d\n", id, value);
}
else {
    /*
     * function request, so get function descriptor and call it
     */
    DLL_FN* fn = (DLL_FN*) (dllqueryfn(dllHandle, id));
    if (fn == NULL) {
        perror("DLL-Query-Fn");
        fprintf(stderr, "Function %s() not exported from %s\n", id, dll);
        return(8);
    }
    value = fn();
    printf("Result of call to %s() is %d\n", id, value);
}
dllfree(dllHandle);

return(0);
}

```

*Explicit use of a DLL in an application using the dllload() family of functions (Part 2 of 2)*

Figure 60 on page 287 shows an example that uses the dlopen() family of functions.

```

#define _UNIX03_SOURCE

#include <dlfcn.h>
#include <stdio.h>
#include <string.h>

#ifdef __cplusplus
extern "C" {
#endif

    typedef int (DLL_FN)(void);

#ifdef __cplusplus
}
#endif

#define FUNCTION      "FUNCTION"
#define VARIABLE      "VARIABLE"

static void Syntax(const char* progName) {
    fprintf(stderr, "Syntax: %s <DLL-name> <type> <identifier>\n"
        "   where\n"
        "   <DLL-name> is the DLL to open,\n"
        "   <type> can be one of FUNCTION or VARIABLE,\n"
        "   and <identifier> is the symbol to reference\n"
        "   (either a function or variable, as determined by"
        "   <type>)\n", progName);
    return;
}

main(int argc, char* argv[]) {
    int value;
    void* symPtr;
    char* dll;
    char* type;
    char* id;
    void* dllHandle;

    if (argc != 4) {
        Syntax(argv[0]);
        return(4);
    }

    dll = argv[1];
    type = argv[2];
    id = argv[3];

    dllHandle = dlopen(dll, 0);
    if (dllHandle == NULL) {
        fprintf(stderr, "dlopen() of DLL %s failed: %s\n", dll, dlerror());
        return(8);
    }
}

```

*Explicit use of a DLL in an application using the dlopen() family of functions (Part 1 of 2)*

*Figure 60. Explicit use of a DLL in an application using the dlopen() family of functions*

```

/*
 * get address of symbol (may be either function or variable)
 */
symPtr = (int*)(dlsym(dllHandle, id));
if (symPtr == NULL) {
    fprintf(stderr, "dlsym() error: symbol %s not exported from %s: %s\n"
        , id, dll, dlerror());
    return(8);
}

if (strcmp(type, FUNCTION) {
    if (strcmp(type, VARIABLE) {
        fprintf(stderr,
            "Type specified was not " FUNCTION " or " VARIABLE "\n");
        Syntax(argv[0]);
        return(8);
    }
}
/*
 * variable request, so display its value
 */
value = *(int *)symPtr;
printf("Variable %s has a value of %d\n", id, value);
}
else {
    /*
     * function request, so call it and display its return value
     */
    value = ((DLL_FN *)symPtr)();
    printf("Result of call to %s() is %d\n", id, value);
}
dlclose(dllHandle);

return(0);
}

```

*Explicit use of a DLL in an application using the dlopen() family of functions (Part 2 of 2)*

---

## Managing the use of DLLs when running DLL applications

This section describes how z/OS XL C/C++ manages loading, sharing and freeing DLLs when you run a DLL application.

### Loading DLLs

When you load a DLL for the first time, either implicitly or by an explicit `dllload()` or `dlopen()`, writable static is initialized. If the DLL is written in C++ and contains static objects, then their constructors are run.

You can load DLLs from a UNIX file system as well as from conventional data sets. The following list specifies the order of a search for unambiguous and ambiguous file names.

- **Unambiguous file names**

- If the file has an unambiguous z/OS UNIX file system name (it starts with a `./` or contains a `/`), the file is searched for only in the UNIX file system.
- If the file has an unambiguous MVS name, and starts with two slashes (`//`), the file is only searched for in MVS.

- **Ambiguous file names**

For ambiguous cases, the settings for POSIX are checked.

- When specifying the `POSIX(ON)` runtime option, the runtime library attempts to load the DLL as follows:

1. An attempt is made to load the DLL from the UNIX file system. This is done using the system service BPX1LOD. For more information on this service, see *z/OS UNIX System Services Programming: Assembler Callable Services Reference*.

If the environment variable LIBPATH is set, each directory listed will be searched for the DLL. See Chapter 32, "Using environment variables," on page 467 for information on LIBPATH. Otherwise the current directory will be searched for the DLL. Note that a search for the DLL in the UNIX file system is case-sensitive.

- If the DLL is found and contains an external link name of eight characters or less, the uppercase external link name is used to attempt a LOAD from the caller's MVS load library search order. If the DLL is not found or the external link name is more than eight characters, then the load fails.
  - If the DLL is found and its sticky bit is on, any suffix is stripped off. Next, the name is converted to uppercase, and the base DLL name is used to attempt a LOAD from the caller's MVS load library search order. If the DLL is not found or the base DLL name is more than eight characters, the version of the DLL in the UNIX file system is loaded.
  - If the DLL is found and does not fall into one of the previous two cases, a load from the UNIX file system is attempted.
2. If the DLL could not be loaded from the UNIX file system, an attempt is made to load the DLL from the caller's MVS load library search order. This is done by calling the LOAD service with the DLL name, which must be eight characters or less (it will be converted to uppercase). LOAD searches for it in the following sequence:
    - a. Runtime library services (if active)
    - b. Job Pack Area (JPA)
    - c. TASKLIB
    - d. STEPLIB or JOBLIB. If both are allocated, the system searches STEPLIB and ignores JOBLIB.
    - e. LPA
    - f. Libraries in the linklist

For more information, see *z/OS MVS Initialization and Tuning Guide*.

- When POSIX(OFF) is specified the sequence is reversed.
  - An attempt to load the DLL is made from the caller's MVS load library search order.
  - If the DLL could not be loaded from the caller's MVS load library then an attempt is made to load the DLL from the UNIX file system.

**Recommendation:** All DLLs used by an application should be referred to by unique names, whether ambiguous or not. Using multiple names for the same DLL (eg. aliases or symlinks) may result in a decrease in DLL load performance. The use of UNIX file system symbolic links by themselves will not degrade performance, as long as the application refers to the DLL solely through the symbolic link name. To help ensure this, when building an application with implicit DLL references always use the same side deck for each DLL. Also, make sure that explicit DLL references with `dllload()` or `dlopen()` specify the same DLL name (case matters for UNIX file system loads).

Changing the search order for DLLs while the application is running (eg. changing LIBPATH) may result in errors if ambiguous file names are used.

## Sharing DLLs

DLLs are shared at the enclave level (as defined by the z/OS Language Environment). A referenced DLL is loaded only once per enclave and only one copy of the writable static is created or maintained per DLL per enclave. Thus, one copy of a DLL serves all modules in an enclave regardless of whether the DLL is loaded implicitly or explicitly. You can access the same DLL within an enclave both implicitly and by explicit runtime services.

All accesses to a variable in a DLL in an enclave refer to the only copy of that variable. All accesses to a function in a DLL in an enclave refer to the only copy of that function.

Although only one copy of a DLL is maintained per enclave, multiple logical loads are counted and used to determine when the DLL can be deleted. For a given DLL in a given enclave, there is one logical load for each explicit `dllload()` or `dlopen()` request. DLLs that are referenced implicitly may be logically loaded at application initialization time if the application references any data exported by the DLL, or the logical load may occur during the first implicit call to a function exported by the DLL.

DLLs are not shared in a nested enclave environment. Only the enclave that loaded the DLL can access functions and variables.

## Freeing DLLs

You can free explicitly loaded DLLs with a `dllfree()` or `dllclose()` request. This request is optional because the DLLs are automatically deleted by the runtime library when the enclave is terminated.

Implicitly loaded DLLs cannot be deleted from the DLL application code. They are deleted by the runtime library at enclave termination. Therefore, if a DLL has been both explicitly and implicitly loaded, the DLL can only be deleted by the run time when the enclave is terminated.

---

## Creating a DLL or a DLL application

Building a DLL or a DLL application is similar to creating a C or C++ application. It involves the following steps:

1. Writing your source code
2. Compiling your source code
3. Binding your object modules

---

## Building a simple DLL

This section shows how to build a simple DLL in C and C++, using techniques that export externally-linked functions and variables to DLL users. These techniques include:

- The `#pragma export` directive
- The `_Export` keyword
- The `EXPORTALL` compiler option

Both the `_Export` keyword and the `export` directive are used to specify functions and variables.

The EXPORTALL compiler option is used to export all defined functions and variables. Using the EXPORTALL compiler option means that all defined functions and variables are accessible by all users of the given DLL.

**Notes:**

1. If the EXPORTALL compiler option is used, then neither #pragma export nor \_Export is required in your code.
2. Exporting all functions and variables has a performance penalty, especially when the IPA compiler option is used to build the DLL.

For more information, see:

- The EXPORTALL compiler option in *z/OS XL C/C++ User's Guide*
- The \_Export keyword in *z/OS XL C/C++ Language Reference*
- The export directive in *z/OS XL C/C++ User's Guide*

## Example of building a simple C DLL

To build a simple C DLL, use the #pragma export directive to export specific external functions and variables as shown in Figure 61.

---

```
#pragma export(bopen)
#pragma export(bcloses)
#pragma export(bread)
#pragma export(bwrite)
int bopen(const char* file, const char* mode) {
    ...
}
int bcloses(int) {
    ...
}
int bread(int bytes) {
    ...
}
int bwrite(int bytes) {
    ...
}
#pragma export(berror)
int berror;
char buffer[1024];
...
```

---

Figure 61. Using #pragma export to create a DLL executable module named BASICIO

This example exports the functions bopen(), bcloses(), bread(), bwrite(), and the variable berror. The variable buffer is not exported.

Compiling with the EXPORTALL compiler option would export all the functions and the buffer variable.

## Example of building a simple C++ DLL

To build a simple C++ DLL, use the \_Export keyword or the #pragma export directive to export specific external functions and variables. Ensure that classes and class members are exported correctly, especially if they use templates.

For example, Figure 62 on page 292 shows how to create a DLL executable module named triangle using the #pragma export directive. This example exports the functions getarea(), getperim(), the static member objectCount, and the

constructor for class triangle.

---

```
class triangle
{
    public:
        static int objectCount;
        getarea();
        getperim();
        triangle(void);
};
#pragma export(triangle::objectCount)
#pragma export(triangle::getarea())
#pragma export(triangle::getperim())
#pragma export(triangle::triangle(void))
```

---

*Figure 62. Using #pragma export to create the triangle DLL executable module*

Similarly, Figure 63 shows how to create a DLL executable module named triangle using the `_Export` keyword:

---

```
{
    public:
        static int _Export objectCount;
        double _Export getarea();
        double _Export getperim();
        _Export triangle::triangle(void);
};
```

---

*Figure 63. Using \_Export to create the triangle DLL executable module*

There are some restrictions when using the `_Export` keyword.

- Do not inline the function if you apply the `_Export` keyword to the function declaration, as in Figure 63
- Always export constructors and destructors

If you apply the `_Export` keyword to a class, then it automatically exports the static members, defined functions, constructors, and destructors of that class, as shown in the following example. This behavior is the same as using the `EXPORTALL` compiler option.

---

```
class triangle
{
    public:
        static int objectCount;
        double getarea();
        double getperim();
        triangle(void);
};
```

---

## Compiling your code

For C source code compiled **without** using the `DLL` or `XPLINK` compiler options, that code cannot reference (import) functions or variables that are exported by a DLL. `NODLL` is the default when compiling C source code, and the `XPLINK` compiler option is not used. C source code compiled with the `DLL` or `XPLINK` compiler options, and all C++ source code, can reference exported functions and variables.

Source code that can reference exported functions and variables is called DLL application code. It need not itself be a DLL, in that it may not itself export any functions or variables.

When compiling DLL application source code, the compiler generates object code in such a way that references to external functions and variables can be resolved statically or dynamically (that is, resolved to a DLL). If you are uncertain whether non-XPLINK C source code references a DLL, you should specify the DLL or XPLINK compiler options. Compiling source code as DLL application code eliminates the potential compatibility problems that may occur when binding DLL application code with non-DLL application code. See Chapter 22, “Building complex DLLs,” on page 301 for more information on compatibility issues.

The decision to use XPLINK needs to be made independently from the decision to build a DLL application. While XPLINK compiled code is always DLL application code, the XPLINK and non-XPLINK function call linkages are different. There is DLL compatibility for XPLINK and non-XPLINK at the DLL boundary, but XPLINK and non-XPLINK object modules cannot be mixed in the same DLL. Also, there is a performance penalty when transitioning between XPLINK and non-XPLINK DLLs (and vice versa). It is best to have a DLL application made up of all XPLINK or all non-XPLINK executable modules to the extent that is possible. For more information on XPLINK, see “Using the XPLINK option” on page 731.

## Binding your code

When creating a DLL, the binder automatically creates a definition side-deck that describes the functions and the variables that can be imported by DLL applications. You must provide the generated definition side-deck to all users of the DLL. Any DLL application that implicitly loads the DLL must include the definition side-deck when they bind. For information about creating a side-deck, refer to Binding z/OS XL C/C++ programs in *z/OS XL C/C++ User's Guide*.

**Note:** You can choose to store your DLL in a PDS load library, but only if it is non-XPLINK. Otherwise, it must be stored in a PDSE load library or in the UNIX file system. To target a PDS load library, prelink and link your code rather than using the binder. For information on prelinking and linking, see Prelinker and linkage editor options in *z/OS XL C/C++ User's Guide*.

When binding the C object module as shown in Figure 61 on page 291, the binder generates the following definition side-deck:

---

```
IMPORT CODE,BASICIO, 'bopen'  
IMPORT CODE,BASICIO, 'bclose'  
IMPORT CODE,BASICIO, 'bread'  
IMPORT CODE,BASICIO, 'bwrite'  
IMPORT DATA,BASICIO, 'berror'
```

---

**Note:** You should also provide a header file containing the prototypes for exported functions and external variable declarations for exported variables.

When binding the C++ object modules shown in Figure 62 on page 292, the binder generates the following definition side-deck.



---

```
IMPORT CODE,TRIANGLE,'getarea__8triangleFv'  
IMPORT CODE,TRIANGLE,'getperim__8triangleFv'  
IMPORT CODE,TRIANGLE,'__ct__8triangleFv'
```

---

You can edit the definition side-deck to remove any functions and variables that you do not want to export. You must maintain the file as a binary file with fixed format and a record length of 80 bytes. Also, use proper binder continuation rules if the IMPORT statement spans multiple lines, and you change the length of the statement. In the above example, if you do not want to expose `getperim()`, remove the control statement `IMPORT CODE,TRIANGLE,'getperim__8triangleFv'` from the definition side-deck.

**Notes:**

1. Removing functions and variables from the definition side-deck does not minimize the performance impact caused by specifying the EXPORTALL compiler option.
2. Editing the side-deck is not recommended. If the DLL name needs to be changed, you should bind using the appropriate name. Instead of using the EXPORTALL compiler option, you should remove unnecessary IMPORT statements by using explicit `#pragma export` statements or `_Export` directives.

The definition side-deck contains mangled names of exported C++ functions, such as `getarea__8triangleFv`. To find the original function or variable name in your source module, review the compiler listing, the binder map, or use the CXXFILT utility, if you do not have access to the listings. This will permit you to see both the mangled and demangled names. For more information, see filter utility in *z/OS XL C/C++ User's Guide*.

---

## Building a simple DLL application

A simple DLL application contains object modules that are made up of only DLL-code. The application may consist of multiple source modules. Some of the source modules may contain references to imported functions, imported variables, or both.

### Steps for using an implicitly loaded DLL in your simple DLL application

#### About this task

Perform the following steps to use an implicitly loaded DLL (sometimes called a load-on-call DLL) in your simple DLL application:

#### Procedure

1. Write your code as you would if the functions were statically bound.
2. Compile as follows:
  - Compile your non-XPLINK application C source files with the following compiler options:
    - DLL
    - RENT
    - LONGNAME

These options instruct the compiler to generate special code when calling functions and referencing external variables. If you are using z/OS UNIX, RENT and LONGNAME are already the defaults, so compile as:

```
c89 -W c,DLL ...
```

- Compile your C++ source files normally. A C++ application is always DLL code.
  - For XPLINK, compile your C and C++ source files with the XPLINK compiler option. XPLINK compiled C and C++ source is always DLL code.
3. Bind your object modules as follows:
- If you are using z/OS Batch, use the IBM-supplied procedure when you bind your object modules. You must chose the appropriate procedures for XPLINK or non-XPLINK.
  - If you are not using the IBM-supplied procedure, specify the RENT, DYNAM(DLL), and CASE(MIXED) binder options when you bind your object modules.

**Note:** XPLINK and non-XPLINK use different z/OS Language Environment libraries, and XPLINK requires the C runtime library side-deck for resolution of C runtime library function calls. For more information, see "Planning to Link-Edit and Run" in *z/OS Language Environment Programming Guide*.

- If you are using z/OS UNIX specify the following option for the bind step for c89 or c++.

```
c89 -W 1,DLL
```

If you are using XPLINK, also add the XPLINK option, so that the c89 utility will use the correct z/OS Language Environment libraries and side-decks:

```
c89 -W 1,DLL,XPLINK ...
```

- Include the definition side-deck from the DLL provider in the set of object modules to bind. The binder uses the definition side-deck to resolve references to functions and variables defined in the DLL. If you are referencing multiple DLLs, you must include multiple definition side-decks.

**Note:** Definition side-decks can not be resolved by automatic library call (autocall) processing, so you must specify an INCLUDE statement to explicitly include a definition side-deck for each referenced DLL.

## Results

The following code fragment illustrates how an application can use the DLL described previously. Compile normally and bind with the definition side-deck provided with the TRIANGLE DLL.

---

```
extern int getarea(); /* function prototype */
main () {
    ...
    getarea();      /* imported function reference */
    ...
}
```

---

See Figure 64 on page 297 for a summary of the processing steps required for the application (and related DLLs).

---

## Creating and using DLLs

Figure 64 on page 297 summarizes the use of DLLs for both the DLL provider and for the writer of applications that use them. In this example, application ABC is referencing functions and variables from two DLLs, XYZ and PQR. The connection between DLL preparation and application preparation is shown. Each DLL shown contains a single compilation unit. The same general scheme applies for DLLs composed of multiple compilation units, except that they have multiple compiles and a single bind for each DLL. For simplicity, this example assumes the following:

- ABC does not export variables or functions.
- XYZ and PQR do not use other DLLs.
- The application is completely non-XPLINK and written in C.

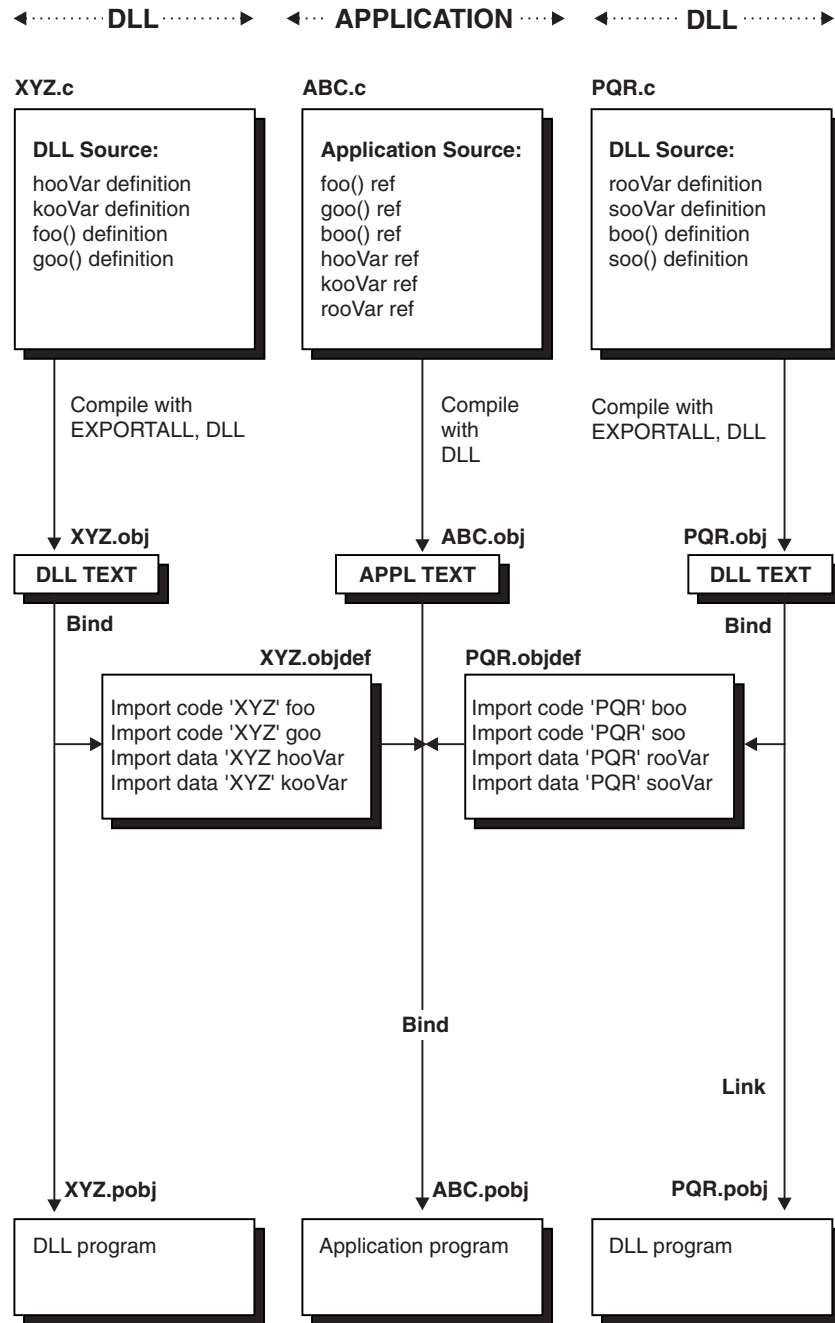

Figure 64. Summary of DLL and DLL application preparation and usage

## DLL restrictions

Consider the following restrictions when creating DLLs and DLL applications:

- The entry point for a DLL must be either z/OS XL C/C++ or Language Environment conforming. An entry point is considered Language Environment conforming if it includes CEESTART or if it was compiled using a Language Environment conforming compiler.

**Note:** If the entry point for a DLL does not meet either of the above conditions, Language Environment issues an error and terminates the application.

- In a DLL application that contains `main()`, `main()` cannot be exported.
- The AMODE of a DLL application must be the same as the AMODE of the DLL that it calls.
- DLL facilities are not available:
  - Under MTF, CSP or SPC
  - To application programs with `main()` written in PL/I that dynamically call z/OS XL C functions
- You cannot implicitly or explicitly perform a physical load of a DLL while running C++ static destructors. However, a logical load of a DLL (meaning that the DLL has previously been loaded into the enclave) is allowed from a static destructor. In this case, references from the load module containing the static destructor to the previously-loaded DLL are resolved.
- If a DLL contains static objects, the constructors are called during DLL load. ISO C++ requires that the global objects must be defined within the same compilation unit, but does not specify any order for these to be called; hence the objects are constructed in the order that they are defined. z/OS XL C/C++ enhances the standard behavior by providing `#pragma priority` to control the construction order for all global objects within the same execution load module. For more information, see the `priority pragma` in *z/OS XL C/C++ Language Reference* for the details of this pragma. A DLL is one execution load module and the `#pragma priority` allows you to control global object construction within a single DLL. On the other hand, you still have no control over the initialization order across different DLLs, or across a DLL application and the DLLs it references. If such order is important, the DLL provider has to define a protocol for applications to follow so that the interaction between the DLL and the applications happens in the required manner. The protocol must be part of the DLL interface design. Take note of the restriction in the previous bullet when defining such a protocol. A simple example would be requiring an application to call a `setup()` function, which is exported by a DLL, before any other references to the same DLL are made. More elaborate designs are possible. The techniques for controlling static initialization are well-discussed in C++ literature; you can reference, for example, Item 47 of Scott Meyers's *Effective C++, 50 Specific Ways to Improve Your Programs and Designs*.
- You cannot use the functions `set_new_handler()` or `set_unexpected()` in a DLL if the DLL application is expected to invoke the new handler or unexpected function routines.
- When using the explicit DLL functions in a multithreaded environment, avoid any situation where one thread frees a DLL while another thread calls any of the DLL functions. For example, this situation occurs when a `main()` function uses `dllload()` or `dlopen()` to load a DLL, and then creates a thread that uses the `ftw()` function. The `ftw()` target function routine is in the DLL. If the `main()` function uses `dllfree()` or `dllclose()` to free the DLL, but the created thread uses `ftw()` at any point, you will get an abend.  
To avoid a situation where one thread frees a DLL while another thread calls a DLL function, do either of the following:
  - Do not free any DLLs by using `dllfree()` or `dllclose()` (the z/OS Language Environment will free them when the enclave is terminated).
  - Have the `main()` function call `dllfree()` or `dllclose()` only after all threads have been terminated.
- For DLLs to be processed by IPA, they must contain at least one function or method. Data-only DLLs will result in a compilation error.

- Use of circular DLLs may result in unpredictable behavior related to the initialization of non-local static objects. For example, if a static constructor (being run as part of loading DLL "A") causes another DLL "B" to be loaded, then DLL "B" (or any other DLLs that "B" causes to be loaded before static constructors for DLL "A" have completed) cannot expect non-local static objects in "A" to be initialized (that is what static constructors do). You should ensure that non-local static objects are initialized before they are used, by coding techniques such as counters or by placing the static objects inside functions.
- DLLs are enclave-level resources and, when opening and closing DLLs in a multithreaded environment, an application must control DLL load ordering with its own serialization mechanism to avoid unpredictable results.

**Example:** Unless the application controls the order of DLL loads, unpredictable results can occur when different threads perform the following operations at the same time:

- One thread uses a global symbol object handle, obtained via `dlopen()`, to search for a symbol whose name has been defined in various DLLs with different values.
- Another thread closes the DLL that defines the symbol whose value is being sought.

## Improving performance

This section contains some hints on using DLLs efficiently. Effective use of DLLs may improve the performance of your application. Following are some suggestions that may improve performance:

- If you are using a particular DLL frequently across multiple address spaces, the DLL can be installed in the LPA or ELPA. When the DLL resides in a PDSE, the dynamic LPA services should be used (this will always be the case for XPLINK applications). Installing in the LPA/ELPA may give you the performance benefits of a single rather than multiple load of the DLL.
- When writing XPLINK applications, avoid frequent calls from XPLINK to non-XPLINK DLLs, and vice-versa. These transitions are expensive, so you should build as much of the application as possible as either XPLINK or non-XPLINK. When there is a relatively large amount of function calls compared to the rest of the code, the performance of an XPLINK application can be significantly better than non-XPLINK. It is acceptable to make calls between XPLINK and non-XPLINK, when a relatively large amount of processing will be done once the call is made.
- Be sure to specify the RENT option when you bind your code. Otherwise, each load of a DLL results in a separately loaded DLL with its own writable static. Besides the performance implications of this, you are likely to get incorrect results if the DLL exports variables (data).
- Group external variables into one external structure.
- When using z/OS UNIX avoid unnecessary load attempts.

z/OS Language Environment supports loading a DLL residing in the UNIX file system or a data set. However, the location from which it tries to load the DLL first varies depending whether your application runs with the runtime option `POSIX(ON)` or `POSIX(OFF)`.

If your application runs with `POSIX(ON)`, z/OS Language Environment tries to load the DLL from the UNIX file system first. If your DLL is a data set member, you can avoid searching the UNIX file system directories. To direct a DLL search to a data set, prefix the DLL name with two slashes (`//`), as shown in the following example.

```
//MYDLL
```

If your application runs with POSIX(OFF), z/OS Language Environment tries to load your DLL from a data set. If your DLL is a UNIX file system file, you can avoid searching a data set. To direct a DLL search to the UNIX file system, prefix the DLL name with a period and slash (./), as shown in the following example.

```
./mydll
```

**Note:** DLL names are case sensitive in the UNIX file system. If you specify the wrong case for your DLL that resides in the UNIX file system, it will not be found in the UNIX file system.

- For IPA, you should only export subprograms (functions and C++ methods) or variables that you need for the interface to the final DLL. If you export subprograms or variables unnecessarily (for example, by using the EXPORTALL option), you severely limit IPA optimization. In this case, global variable coalescing and pruning of unreachable or 100% inlined code does not occur. To be processed by IPA, DLLs must contain at least one subprogram. Attempts to process a data-only DLL will result in a compilation error.
- The suboption NOCALLBACKANY of the compiler option DLL is more efficient than the CALLBACKANY suboption. The CALLBACKANY option calls z/OS Language Environment at run time. This runtime service enables direct function calls. Direct function calls are function calls through function pointers that point to actual function entry points rather than function descriptors. The use of CALLBACKANY will result in extra overhead at every occurrence of a call through a function pointer. This is unnecessary if the calls are not direct function calls.

---

## Chapter 22. Building complex DLLs

Before you attempt to build complex DLLs, it is important to understand the differences between the terms DLL, DLL code, and DLL application.

A **DLL** (Dynamic Link Library) is a file containing executable code and data bound to a program at run time. The code and data in a DLL can be shared by several applications simultaneously. It is important to note that compiling code with the DLL option does not mean that the produced executable will be a DLL. To create a DLL, you must use the `#pragma export` or `EXPORTALL` compiler option.

**DLL code** is code that can use a DLL. The following are DLL code:

- C++ code
- C code compiled using the DLL or XPLINK option

Code written in languages other than C++ and compiled without the DLL or XPLINK option is non-DLL code.

A **DLL application** is an application that can use exported functions or variables that are bound with DLL code. All of the source files that make up a DLL application do not need to be compiled with the DLL or XPLINK option, only the source files that reference exported functions and exported global variables.

If you link DLL code with non-DLL code, the resulting DLL or DLL application is called **complex**. You might compile your code as non-DLL for the following reasons:

- Source modules do not use C or C++.
- To prevent problems which occur when a non-DLL function pointer call uses DLL code. This problem takes place when a function makes a call through a function pointer that points to a function entry rather than a function descriptor.

For complex DLLs and DLL applications that you compile without XPLINK, you can use the CBA suboption of the `DLL|NODLL` compiler option. With this suboption, a call is made, through a function pointer, to the z/OS Language Environment, for each function call, at run time. This call eliminates the error that would occur when a non-DLL function pointer passes a value to DLL code.

**Note:** In this book, unless otherwise specified, all references to the `DLL|NODLL` compiler option assume suboption `NOCBA`. For more information, see the DLL compiler option in *z/OS XL C/C++ User's Guide*.

If you specify the XPLINK compiler option, the CBA and NOCBA suboptions of DLL and NODLL are ignored.

There are two ways to combine XPLINK and non-XPLINK code in the same application:

- Compile each entire DLL with XPLINK or without XPLINK. The only interaction between XPLINK and non-XPLINK code occurs at a DLL or `fetch()` boundary.
- Use the `OS_UPSTACK`, `OS_NOSTACK`, and `OS31_NOSTACK` linkage directive. For more information, see the description of the `linkage` pragma in *z/OS XL C/C++ Language Reference*.



The steps for creating a complex DLL or DLL application are:

1. Determining how to compile your source modules.
2. Modifying the source modules that do not meet all the DLL rules.
3. Compiling the source modules to produce DLL code and non-DLL code as determined in the previous steps.
4. Binding your DLL or DLL application.

The focus of this chapter is step 1 and step 2. You perform step 3 the same way you would for any other C or C++ application. "Binding your code" on page 293 explains step 4.

---

## Rules for compiling source code with XPLINK

This section provides guidelines for compiling with the XPLINK and NOXPLINK compiler options. See XPLINK in *z/OS XL C/C++ User's Guide* for the details of this option.

### XPLINK applications

XPLINK provides compatibility with non-XPLINK functions when calls are made across executable modules, using either the DLL or `fetch()` call mechanism. You should make a reference from XPLINK code into non-XPLINK code only if the reference is by an imported function or variable, or the function pointer is a parameter into the XPLINK code. This prevents incompatible references to a non-XPLINK function entry point.

Non-XPLINK code can expose a function entry point directly to the XPLINK code:

- as a global variable
- as part of a structure that is passed as a parameter
- by passing an explicit return value

A function pointer from a non-XPLINK application can be used as a callback by passing it as an argument into the XPLINK function, or as a member of a structure that is itself an argument to the XPLINK function.

Prior to z/OS V1R8, a function entry point from a non-XPLINK application only could be passed explicitly as an argument into a XPLINK function. This restriction did not apply if you used the compiler option `XPLINK(CALLBACK)` or the `__callback` qualifier where any such function pointers were used. Existing DLLs compiled using one of these options do not need to be recompiled. The use of these options can only be discontinued if the owner of the XPLink-compiled DLL is certain that any non-XPLink-compiled DLL callers have been recompiled with z/OS XL C/C++ V1R8 targetting z/OS Language Environment V1R8 or later, and those applications are targetted for and running on z/OS Language Environment V1R8 or later.

Also, note the following restrictions:

- DLLs must be created using the binder.
- C/C++ source modules must be compiled code using the DLL and GOFF options without the XPLink or LP64 option.
- Non-XPLink assembler DLLs are not supported.

## Modifying noncompliant source

For each function pointer, make sure that one of the following is true:

- The function pointer is passed as a parameter to the XPLINK code.
- The indirectly-referenced function pointer was imported by this DLL.
- The indirectly-referenced function pointer was imported by another XPLINK or non-XPLINK DLL.

## Non-XPLINK applications

To create a complex DLL or DLL application, you must comply with the following rules that dictate how you compile source modules. The first decision you must make is how you should compile your code. You determine whether to compile with either the DLL or NODLL compiler option based on whether or not your code references any other DLLs. Even if your code is a DLL, it is safe to compile your code with the NODLL compiler option if your code does not reference other DLLs.

The second decision you must make is whether to compile with the default compiler suboption for DLL | NODLL, which is NOCBA, or use the alternative suboption CBA. This decision is based upon your knowledge of the code you reference. If you are sure that you do not reference any function calls through function pointers that point to a function entry rather than a function descriptor, use the NOCBA suboption. Otherwise, you should use the CBA suboption.

As of V2R4 of OS/390<sup>®</sup> C/C++, use the following options to ensure that you do not have undefined results as a result of the function pointer pointing to a function entry rather than a function descriptor:

1. Compile your source module with the CBA suboption of DLL | NODLL. This option inserts extra code whenever you have a function call through a function pointer. The inserted code invokes a runtime service of z/OS Language Environment which enables direct function calls through C/C++ function pointers. Direct function calls are function calls through function pointers that point to actual function entry points rather than function descriptors. The drawback of this method is that your code will run slower. This occurs because whenever you have function calls through function pointers z/OS Language Environment is called at run time to enable direct function calls. See Figure 73 on page 312 for an example of the CBA suboption and an explanation of what the called z/OS Language Environment routine does at run time when using the CBA suboption.
2. Compile your C source module with the NOCBA suboption of DLL | NODLL. This option has the benefit of faster running but with more restrictions placed on your coding style. If you do not follow the restrictions, your code may behave unpredictably. See “DLL restrictions” on page 297 for more information.

Compile your C source modules as DLL when:

1. Your source module calls imported functions or imported variables by name.
2. Your source module contains a comparison of function pointers that may be DLL function pointers.

The comparisons shown in “Function pointer comparison in non-DLL code” on page 314 are undefined. To obtain valid comparisons, compile the source modules as DLL code.

3. Your source module may pass a function pointer to DLL code through a parameter or a return value.

If the `sort()` routine in Figure 72 on page 311 is compiled as DLL code instead of non-DLL code, non-DLL applications can no longer call it. To be able to call the DLL code version of `sort()`, the original non-DLL application must be recompiled as DLL code.

4. Your source module may define a global function pointer and another source module changes it.

Consider the example programs shown in Table 46. You have the following two options when compiling them.

- a. If source module 1 is compiled as DLL code, source module 2 must also be compiled as DLL code.
- b. Alternately, you can compile source module 1 as DLL and source module 2 as NODLL(CBA).

Table 46. Example programs to demonstrate compiling options

Source module 1	Source module 2
<pre>void (*fp)(void); extern void goo (void); void main() {     goo();     (*fp)();    /* call hello function */ }</pre>	<pre>#include &lt;stdio.h&gt; extern void (*fp)(void); void hello(void) {     printf("hello\n"); } void goo(void) {     fp = hello; }</pre>

Table 47 summarizes some of the ways that you could compile the two source modules and list the results. Both modules are linked into a single executable.

Table 47. Examples of how to compile two source modules and list result

How Modules Were Compiled	Result
<ul style="list-style-type: none"> <li>• Source module 1 NODLL (NOCBA)</li> <li>• Source module 2 DLL(NOCBA)</li> </ul>	fp contains a function descriptor. Execution of fp will succeed because it is valid to the address of a function descriptor.
<ul style="list-style-type: none"> <li>• Source module 1 DLL(NOCBA)</li> <li>• Source module 2 NODLL(NOCBA)</li> </ul>	fp contains the address of <code>hello</code> . The execution of fp would abend because source module 1 expects fp to contain a function descriptor for <code>hello</code> .
<ul style="list-style-type: none"> <li>• Source module 1 DLL(CBA)</li> <li>• Source module 2 DLL(NOCBA)</li> </ul>	fp contains a function descriptor. The generated code will function correctly. It will run slower than if the source modules were compiled as DLL(NOCBA) because it will use Language Environment to make the function call.
<ul style="list-style-type: none"> <li>• Source module 1 NODLL(CBA)</li> <li>• Source module 2 DLL(NOCBA)</li> </ul>	A call to Language Environment made by the function call through the function pointer prevents a problem that would have occurred had a direct function call been made.

If you do not use the DLL compiler option, and your source module calls imported functions or imported variables by name, there will be unresolved references to these variables and functions at bind time. A DLL or DLL application that does not comply with these rules may produce undefined runtime behavior. For a detailed explanation of incompatibilities between DLL and non-DLL code, see “Compatibility issues between DLL and non-DLL code” on page 305.

## Modifying noncompliant source

Sometimes source modules of a complex DLL or DLL application do not simultaneously meet all the DLL rules. These rules are documented in the section “Rules for compiling source code with XPLINK” on page 302. When these situations occur, you can use the following methods to solve the problem:

- Use the CBA suboption.
- Rewrite the source in C. Only C source can be compiled as either DLL or non-DLL code. C++ source code is always DLL code.
- Split a C source module in two so that one of the new files is compiled as DLL code and the other is compiled as non-DLL code.

**Note:** In rare cases, you may have to split a function into two functions before you can successfully split the file.

An example of noncompliant source is a C++ source module that contains a function call through a pointer that may be either a DLL pointer to a function descriptor or a direct function pointer. Convert it to C code and compile as non-DLL code or, preferably, as DLL(CBA) and recompile.

---

## Compatibility issues between DLL and non-DLL code

This section describes the differences between DLL code and non-DLL code, and discusses the related compatibility issues for linking them to create complex DLLs.

**Note:** This section does not apply to XPLINK applications. XPLINK code is always DLL code.

Table 48 and Figure 65 on page 306 illustrate DLL code referencing functions and variables.

*Table 48. Referencing functions and external variables*

Function or Variable	DLL
Imported Functions	A function descriptor is created by the binder. The descriptor is in the WSA class and contains the address of the function and the address of the writable static area associated with that function. The function address and the address of the WSA associated with the function is resolved when the DLL is loaded. <b>1</b>
Nonimported Functions	Also called through the function descriptor but the function address is resolved at link time. <b>3</b>
Imported Variables	A variable descriptor is created in the WSA by the binder. It contains addressing information for accessing an imported variable. The address is resolved when the DLL is loaded. <b>2</b>
Nonimported Variables	Direct access <b>4</b>

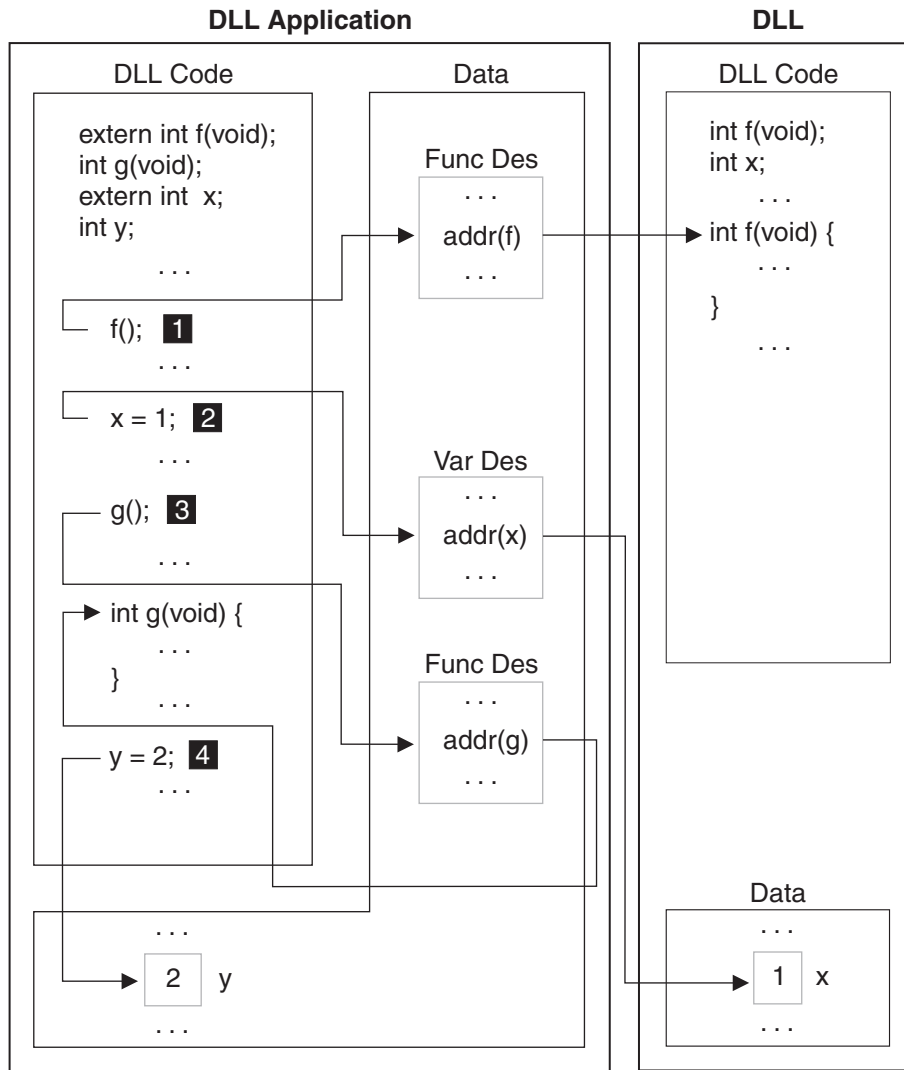

Figure 65. Referencing functions and external variables in DLL code

## Pointer assignment

In DLL code and non-DLL code, the actual address of a variable is assigned to a variable pointer. A valid variable pointer always points to the variable itself and causes no compatibility problems.

## Function pointers

In non-DLL code, the actual address of a nonimported function is assigned to a function pointer. In DLL code, the address of a function descriptor is assigned to a function pointer.

If you assign the address of an imported function to a pointer in non-DLL code, the link step will fail with an unresolved reference. In a complex DLL or DLL application, a pointer to a function descriptor may be passed to non-DLL code. A direct function pointer (pointer to a function entry point) may be passed to DLL code. A parameter, a return value, or an external variable can pass a function pointer or an external variable.

In a complex DLL or DLL application, a function pointer may point either to a function descriptor or to a function entry, depending on the origin of the code. The different ways of dereferencing a function pointer causes the compatibility problem in linking DLL code with non-DLL code.

In Figure 66, **1** assigns the address of the descriptor for the imported function `f` to `fp`. **2** assigns the address of the imported variable `x` to `xp`. **3** assigns the address of the descriptor for the nonimported function `g` to `gp`. **4** assigns the address of the non-imported variable `y` to `yp`.

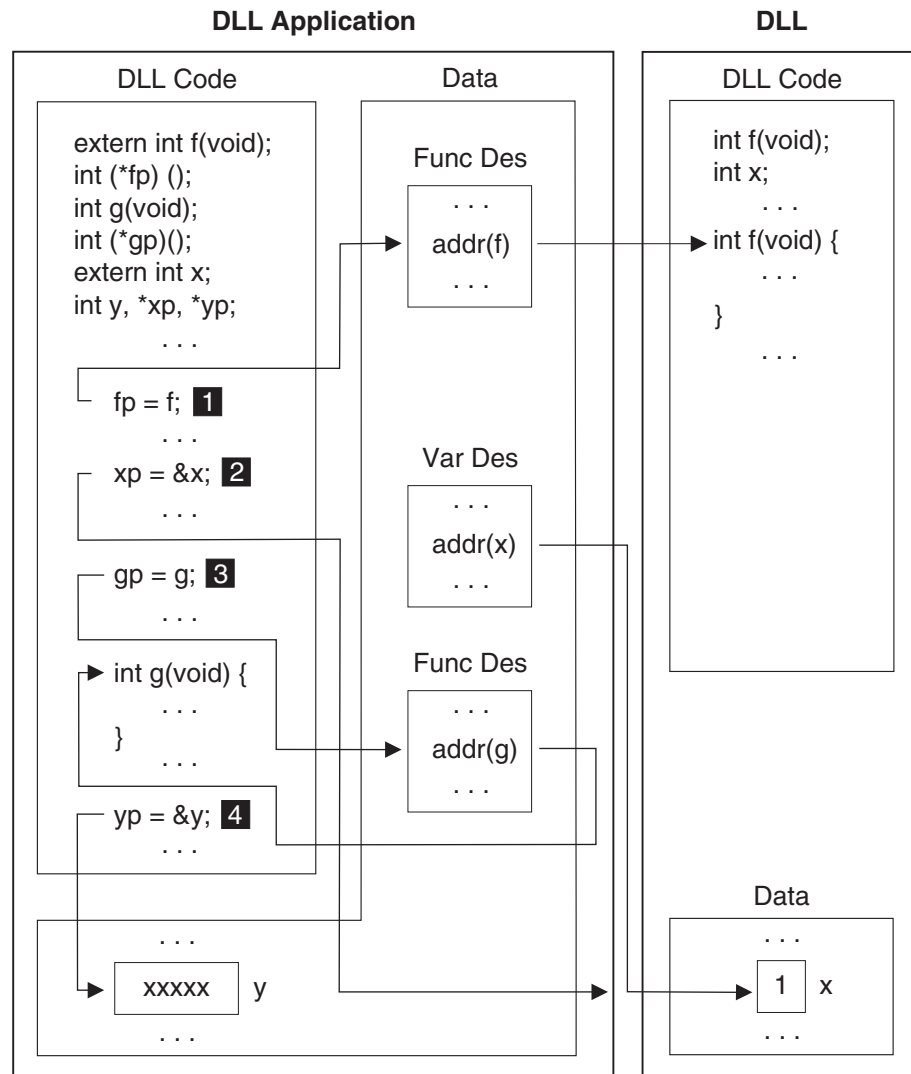

Figure 66. Pointer Assignment in DLL code

In Figure 67 on page 308, **1** causes a bind error because the assignment to `fp` is undefined. **2** causes a binder error because the assignment to `xp` is undefined. **3** assigns `gp` to the address of the nonimported function, `g`. **4** assigns the address of the nonimported variable `y` to `yp`.

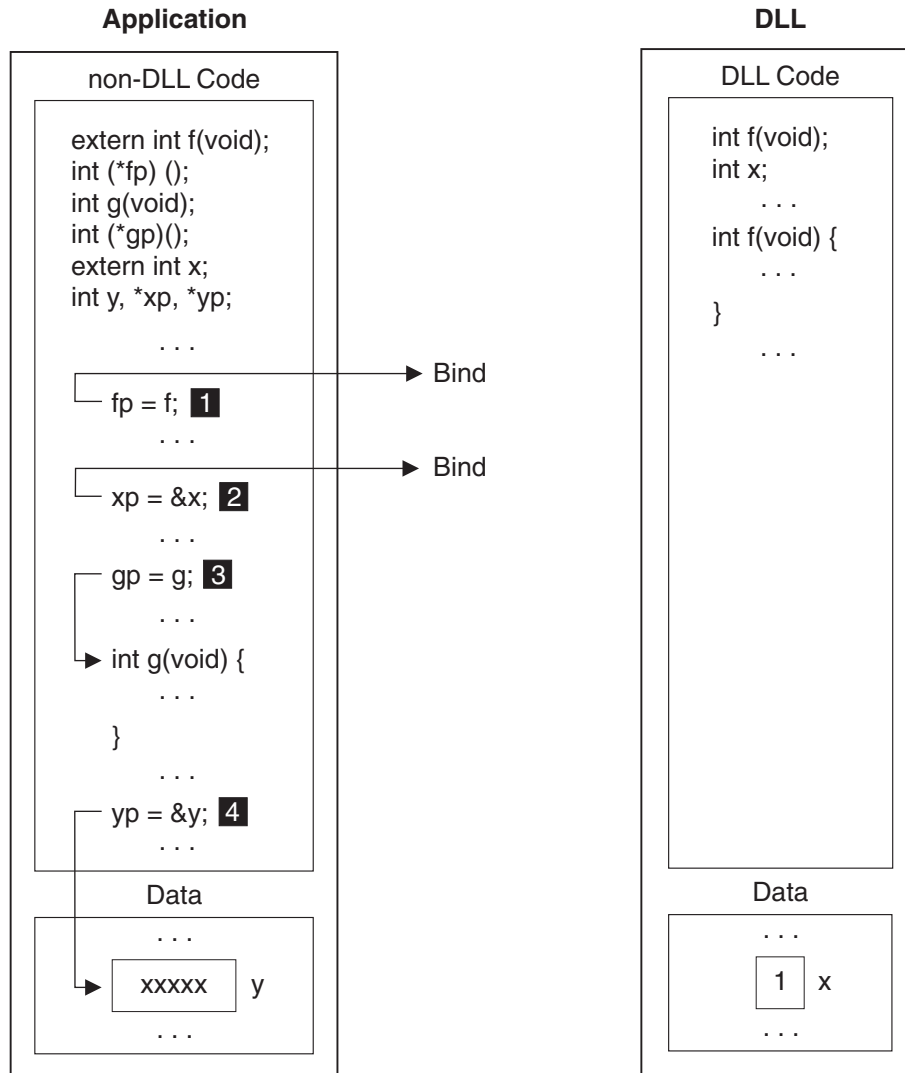

Figure 67. Pointer assignment in non-DLL code

## DLL function pointer call in non-DLL code

Because z/OS XL C/C++ supports a DLL function pointer call in non-DLL code, you are able to create a DLL to support both DLL and non-DLL applications. The z/OS XL C/C++ compiler inserts *glue code* at the beginning of a function descriptor to allow branching to a function descriptor. Glue code is special code that enables function pointer calls from non-DLL code to DLL code, including XPLINK code.

A function pointer in non-DLL code points to the function entry and a function pointer call branches to the function address. However, a DLL function pointer points to a function descriptor. A call made through this pointer in non-DLL code results in branching to the descriptor.

z/OS XL C/C++ executes a DLL function pointer call in non-DLL code by branching to the descriptor and executing the glue code that invokes the actual function.

The following examples and Figure 72 on page 311 show a DLL function pointer call in non-DLL code, where a simplified `sort()` routine is used. Note that the `sort()` routine compiled as non-DLL code can be called from both a DLL application and a non-DLL application.

## C example

File 1 and File 2 are bound together to create application A. File 1 is compiled with the NODLL option. File 2 is compiled with the DLL option (so that it can call the DLL function `sort()`). File 3 is compiled as DLL to create application B. Application A and B can both call the imported function `sort()` from the DLL in file 4.

Figure 68 shows how a file (File 1) of a complex DLL application is compiled with the NODLL option

---

```
typedef int CmpFP(int, int);
void sort(int* arr, int size, CmpFP*);      /* sort routine in DLL      */
void callsort(int* arr, int size, CmpFP* fp); /* routine compiled as DLL */
                                              /* which can call DLL      */
                                              /* routine sort()          */

int comp(int e1, int e2) {
    if (e1 == e2) {
        return(0);
    }
    else if (e1 < e2) {
        return(-1);
    }
    else {
        return(1);
    }
}

main() {
    CmpFP* fp = comp;
    int a[2] = {2,1};
    callsort(a, 2, fp);
    return(0);
}
```

---

Figure 68. File 1. Application A

Figure 69 shows how a file (File 2) of a complex DLL application is compiled with the DLL option.

---

```
typedef int CmpFP(int, int);
void sort(int* arr, int size, CmpFP*);      /* sort routine in DLL      */
void callsort(int* arr, int size, CmpFP* fp) {
    sort(arr, size, fp);
}
```

---

Figure 69. File 2. Application A

Figure 70 on page 310 shows how a simple DLL application is compiled with the DLL option.



---

```

int comp(int e1, int e2) {
    if (e1 == e2)
        return(0);
    else if (e1 < e2)
        return(-1);
    else
        return(1); }
int (*fp)(int e1, int e2);
main()
{
    int a[2] = { 2, 1 };
    fp = comp;      /* assign function address */
    sort(a, 2, fp); /* call sort */
}

```

---

*Figure 70. File 3. Application B*

Figure 71 shows how a DLL is compiled with the NODLL option. File 4 is compiled as NODLL and bound into a DLL. The function `sort()` will be exported to users of the DLL.

---

```

typedef int CmpFP(int, int);
int sort(int* arr, int size, CmpFP* fp) {
    int i,j,temp,rc;

    for (i=0; i<size; ++i) {
        for (j=1; j<size-1; ++j) {
            rc = fp(arr[j-1], arr[j]); /* call 'fp' which may be DLL or no-DLL code */
            if (rc > 0) {
                temp = arr[j];
                arr[j] = arr[j-1];
                arr[j-1] = temp;
            }
        }
    }
    return(0);
}
#pragma export(sort)

```

---

*Figure 71. File 4. DLL*

Non-DLL function pointers can only safely be passed to a DLL if the function referenced is naturally reentrant, that is, it is C code compiled with the `RENT` compiler option, or is C code with no global or static variables. See the discussion on the `CBA` option to see how to make a DLL that can be called by applications that pass constructed reentrant function pointers.

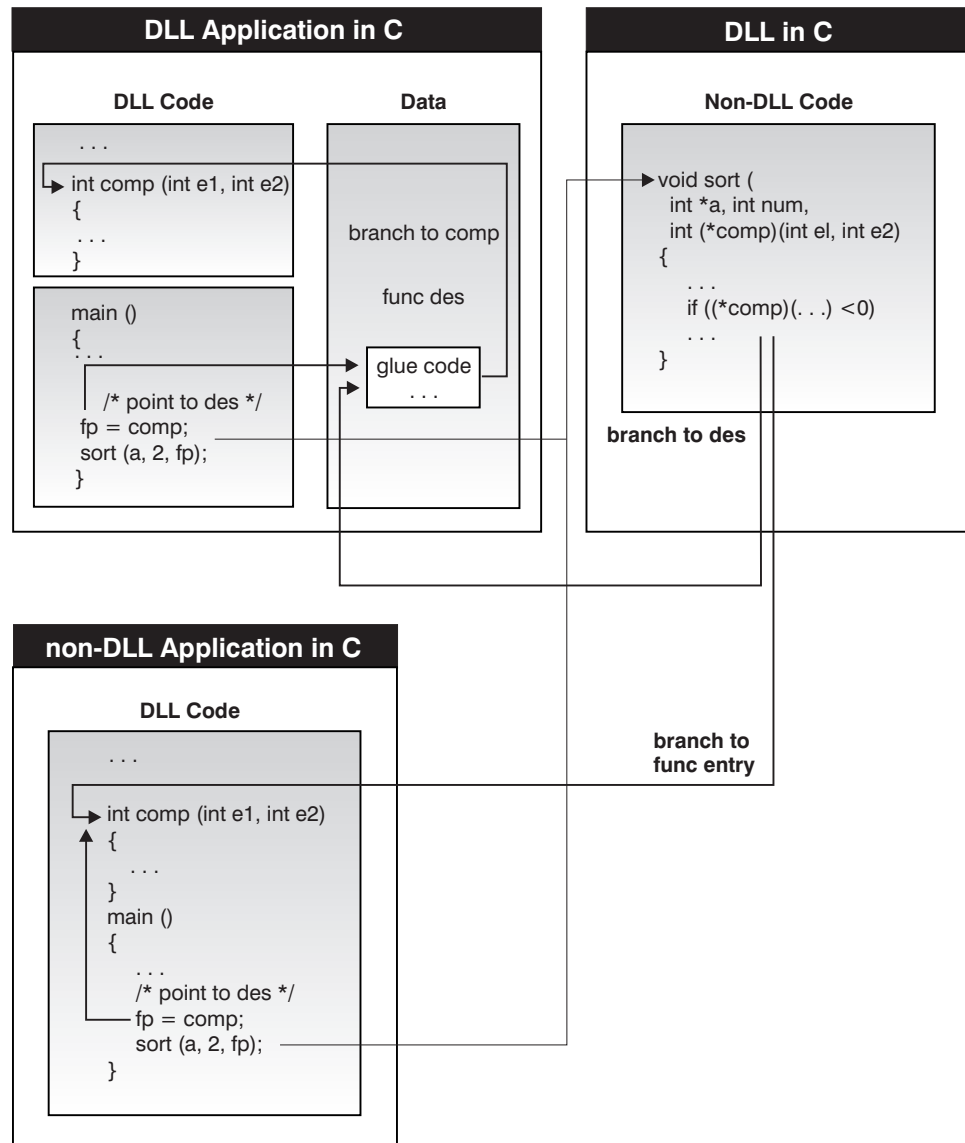

Figure 72. DLL function pointer call in non-DLL code

## Non-DLL function pointer call in DLL(CBA) code

Figure 73 on page 312 illustrates one situation where you could use the CBA suboption. In the example, the DLL provider provides stub routines which the application programmer can bind with their applications. These stub routines allow an application programmer to use a DLL without recompiling the application with the DLL option. This is an important consideration for library providers that want to move from a static version of a library to a dynamic one. Stub routines are not mandatory, however if they are provided, the application programmer only needs to rebind, but not recompile the application. If stub routines are not provided by the DLL provider, the application programmer must recompile the application.

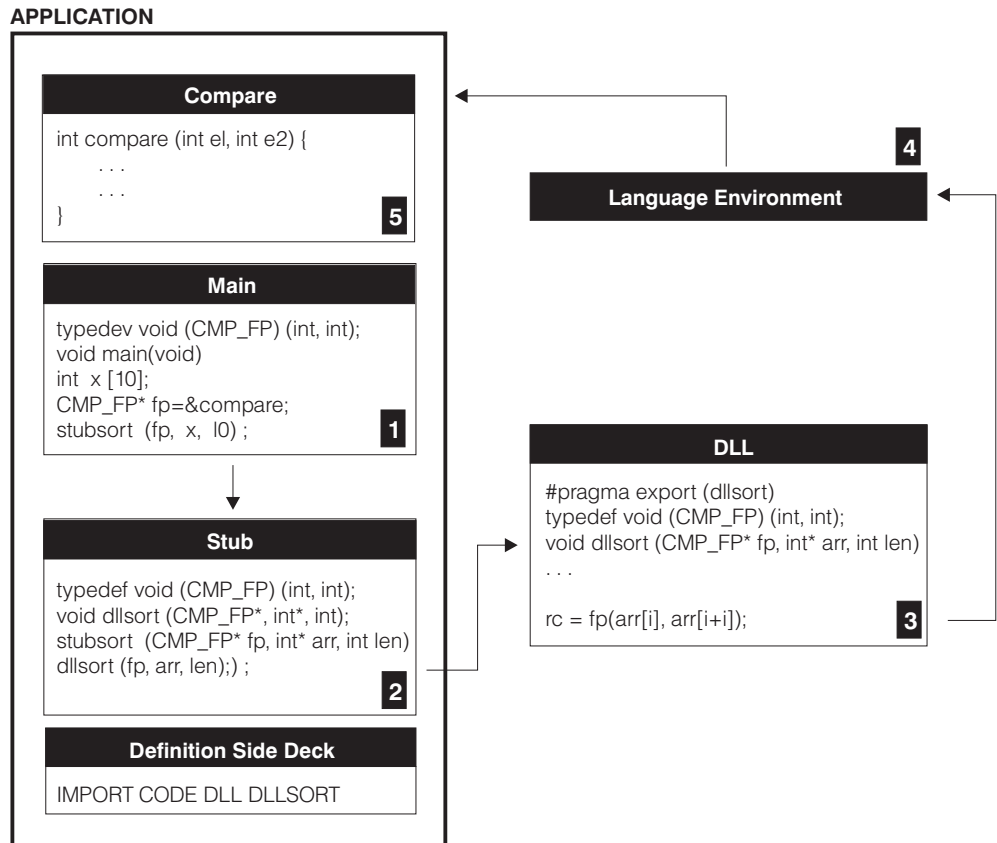

Figure 73. DLL function pointer call in non-DLL code

In the previous example, the DLL provider:

- Compiles the DLL parts as either DLL(CBA) or NODLL(CBA).
- Exports function `dllsort()` for use by other applications.
- Binds the DLL to produce a DLL executable module and a DLL definition side-deck.
- Creates a stub function for every function exported from the DLL. The stub function calls a corresponding function in the DLL. This routine is compiled with the DLL option. The stub functions are provided to the application programmer in a static library to be bound with the application.

The Application Programmer:

- Codes the program using any of the following compiler options;
  - DLL
  - NODLL
  - RENT
  - NORENT
- Calls the stub routines, not the exported functions.

The stub routines must be called because the application programmer may have compiled his code with the NODLL compiler option. Otherwise, references to the DLL functions will be unresolved at bind time. Providing the stub routines allows an application programmer to use a DLL without recompiling the application with the DLL option. This is an important consideration for library

providers that want to move from a static version of a library to a dynamic one. Providing stub routines requires the application programmer to rebind but not recompile the application.

- Statically binds the definition side-deck, provided by the DLL provider, and the stub routines with their program.
- Binds the DLL to produce a DLL executable module and a DLL definition side-deck
- Creates a stub function for every function exported from the DLL. The stub function calls the DLL directly

The reference keys in Figure 73 on page 312 illustrate the sequence of events. Note that in **3**, the user does not explicitly make a call to Language Environment. The generated code for the fp function call makes the call to z/OS Language Environment. z/OS Language Environment does the following at point **4** in the figure:

- Saves the DLL environment
- Establishes the application environment
- Branches to the user's function
- Reestablishes the DLL environment after execution of the function
- Returns control to the DLL.

## Non-DLL function pointer call in DLL code

In DLL code, it is assumed that a function pointer points to a function descriptor. A function pointer call is made by first obtaining the function address through dereferencing the pointer; and then, branching to the function entry. When a non-DLL function pointer is passed to DLL code, it points directly to the function entry. An attempt to dereference through such a pointer produces an undefined function address. The subsequent branching to the undefined address may result in an exception.

The following is an example of passing a non-DLL function pointer to DLL code using an external variable. Its behavior is undefined as shown in Figure 74.

---

```
#include <stdio.h>
extern void (*fp)(void);
void hello(void) {
    printf("hello\n");
}
void goo(void) {
    fp = hello; /* assign address of hello, to fp    */
               /* (refer to                          */
               /* Figure 67 on page 308). */
}
```

---

Figure 74. C non-DLL code

Figure 75 on page 314 shows how dereferencing through a pointer produces an undefined function address in C.

---

```

extern void goo(void);
void (*fp)(void);
void main (void) {
    goo();
    (*fp)();    /* Expect a descriptor, but get a function address, */
               /* so it dereferences to an undefined address and */
               /* call fails */
}

```

---

*Figure 75. C DLL code*

Figure 76 shows how dereferencing through a pointer produces an undefined function address in C++.

---

```

extern "C" void goo(void);
void (*fp)(void);
void main (void) {
    goo();
    (*fp)();    /* Expect a descriptor, but get a function address, */
               /* so it dereferences to an undefined address and */
               /* call fails */
}

```

---

*Figure 76. C++ DLL code*

In Figure 77, a non-DLL function pointer call to an assembler function is resolved.

---

```

/*
 * This function must be compiled as DLL(CBA)
 */

extern "OS" {
    typedef void OS_FP(char *, int *);
}
extern "OS" OS_FP* ASMFN(char*);

int CXXFN(char* p1, int* p2) {
    OS_FP* fptr;

    fptr = ASMFN("ASM FN"); /* returns pointer to address of function */
    if (fptr) {
        fptr(p1, p2); /* call asm function through fn pointer */
    }
    return(0);
}

```

---

*Figure 77. C++ DLL code calling an Assembler function*

## Function pointer comparison in non-DLL code

In non-DLL code, the results of the following function pointer comparisons are undefined:

- Comparing a DLL function pointer to a non-DLL function pointer
- Comparing a DLL function pointer to another DLL function pointer
- Comparing a DLL function pointer to a constant function address

### Comparing a DLL function pointer to a non-DLL function pointer

In Figure 78 on page 315, both the DLL function pointer and the non-DLL function pointer point to the same function; but the pointers, when compared, are unequal.

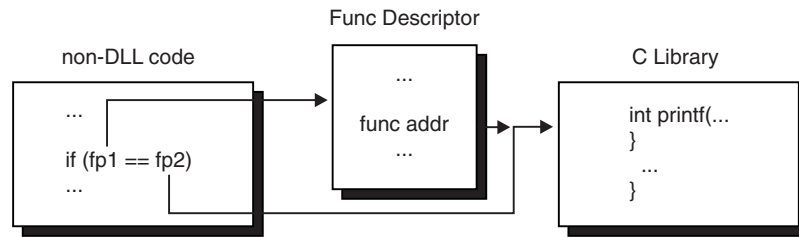

Figure 78. Comparison of function pointers in non-DLL code

## Example of comparing a DLL function pointer to a non-DLL function pointer using C

In the examples shown in Figure 79 and Figure 80, DLL code and non-DLL code can reside either in the same executable file or in different executable files.

---

```
#include <stdio.h>
extern int foo(int (*fp1)(const char *, ...));
main ()
{
    int (*fp)(const char *, ...);
    fp = printf; /* assign address of a descriptor that */
                /* points to printf. */
    if (foo(fp))
        printf("Test result is undefined\n");
}
```

---

Figure 79. C DLL code

---

```
int foo(int (*fp1)(const char *, ...))
{
    int (*fp2)(const char *, ...);
    fp2 = printf; /* assign the address of printf. */
    if (fp1 == fp2) /* comparing address of descriptor to */
                    /* address of printf results in unequal.*/
        return(0);
    else
        return(1);
}
```

---

Figure 80. C non-DLL code

## Comparing a DLL function pointer to another DLL function pointer

The example in Figure 84 on page 316 compares addresses of function descriptors. In the following examples, both of the DLL function pointers point to the same function, but they compare unequal.

### Comparison of two DLL function pointers in non-DLL code

The following example shows a comparison of two DLL function pointers in non-DLL code. In this example, File 1 (Figure 81 on page 316) and File 2 (Figure 82 on page 316) reside in different executable modules. File 3 (Figure 83 on page 316) can reside in the same executable module as File 1 or File 2 or it can reside in a different executable module. In all cases, the addresses of the function descriptors will not compare equally.

---

```

#include <stdio.h>
extern int goo(int (*fp1)(const char *, ...));
main ()
{
    int (*fp)(const char *, ...);
    fp = printf; /* assign address of a descriptor that */
                /* points to printf. */
    if (goo(fp))
        printf("Test result is undefined\n");
}

```

---

Figure 81. File 1 C DLL code

---

```

#include <stdio.h>
extern int foo(int (*fp1)(const char *, ...),
               int (*fp2)(const char *, ...));
int goo(int (*fp1)(const char *, ...))
{
    int (*fp2)(const char *, ...);
    fp2 = printf; /* assign address of a different */
                 /* descriptor that points to printf. */
    return (foo(fp1, fp2));
}

```

---

Figure 82. File 2 C DLL code

---

```

int foo(int (*fp1)(const char *, ...),
        int (*fp2)(const char *, ...))
{
    if (fp1 == fp2) /* comparing the addresses of two */
                   /* descriptors results in unequal. */
        return(0);
    else
        return(1);
}

```

---

Figure 83. File 3 C non-DLL code

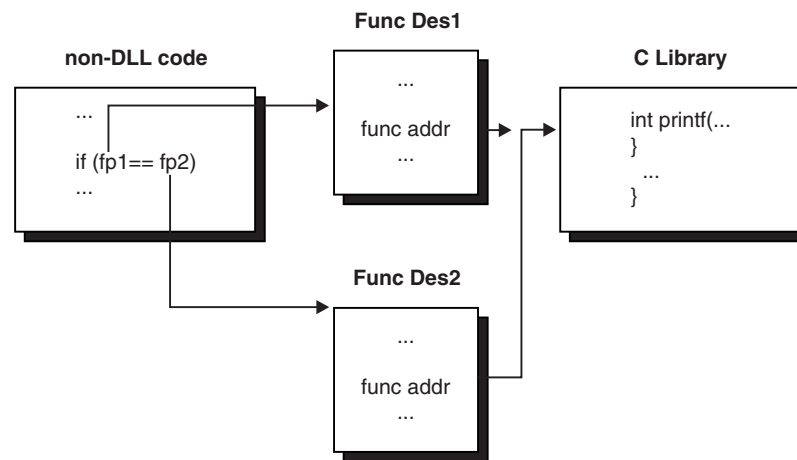

Figure 84. Comparison of two DLL function pointers in non-DLL code

## Comparing a DLL function pointer to a constant function address other than NULL

Here, you are comparing the constant function address to an address of a function descriptor.

**Note:** Comparing a DLL function pointer to NULL is well defined, because when a pointer variable is initialized to NULL in DLL code, it has a value zero.

## Function pointer comparison in DLL code

In XPLINK code, function pointers are compared using the address of the descriptor. No special considerations, such as dereferencing, are required to initialize the function pointer prior to comparison. Function descriptors are guaranteed to be unique throughout the XPLINK application for a particular function, so this comparison of function descriptor addresses will yield the correct results even if the function pointer is passed between executable modules within the XPLINK application. The remainder of this section does not apply to XPLINK applications.

In non-XPLINK DLL code, a function pointer must be NULL before it is compared. For a non-NULL pointer, the pointer is further dereferenced to obtain the function address that is used for the comparison. For an uninitialized function pointer that has a non-zero value, the dereference can cause an exception to occur. This happens if the storage that the uninitialized pointer points to is read-protected.

Usually, comparing uninitialized function pointers results in undefined behavior. You must initialize a function pointer to NULL or the function address (from source view). Two examples follow.

Figure 85 on page 318 shows undefined comparison in DLL code (C or C++).



---

```

#include <stdio.h>
int (*fp2)(const char *, ...) /* Initialize to point to the */
                                = printf; /* descriptor for printf */

int goo(void);
int (*fp2)(void) = goo;
int goo(void) {
    int (*fp1)(void);
    if (fp1 == fp2)
        return (0);
    else
        return (1);
}

void check_fp(void (*fp)()) {
    /* exception likely when -1 is dereferenced below */
    if (fp == (void (*)())-1)
        printf("Found terminator\n");
    else
        fp();
}

void dummy() {
    printf("In function\n");
}

main() {
    void (*fa[2])();
    int i;

    fa[0] = dummy;
    fa[1] = (void (*)())-1;

    for(i=0;i<2;i++)
        check_fp(fa[i]);
}

```

---

Figure 85. Undefined comparison in DLL code (C or C++)

Figure 86 shows that, when fp1 points to a read-protected memory block, an exception occurs.

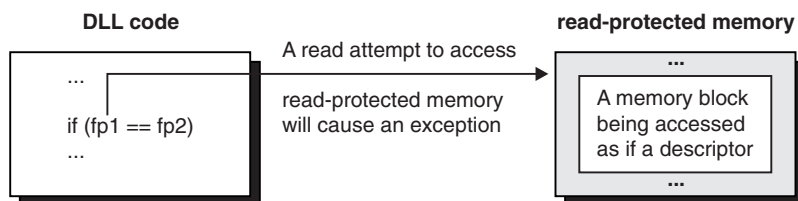

Figure 86. Comparison of function pointers in DLL code (C or C++)

Figure 87 on page 319 is an example of valid comparisons in DLL code.

---

```
#include <stdio.h>
int (*fp1)(const char *, ...); /* An extern variable is implicitly*/
                                /* initialized to zero          */
                                /* if it has not been explicitly */
                                /* initialized in source.        */
int (*fp2)(const char *, ...) /* Initialize to point to the    */
                                = printf; /* descriptor for printf */

int foo(void) {
    if (fp1 != fp2 )
        return (0);
    else
        return (1);
}
```

---

Figure 87. Valid comparisons in DLL code (C or C++)

---

## Using DLLs that call each other

An application can use DLLs that call each other. There are two methods for building these applications, as illustrated in the examples that follow:

- In the first method, the loop is broken by manually creating `IMPORT` statements for the referenced DLLs, when binding one of the DLLs (CCNGA2D3).
- In the second method, an initial bind is done on CCNGA2D3 using the binder `NCAL` parameter, which will be done again after the referenced DLLs are built.

In both cases, the result is that the side-deck is produced for CCNGA2D3, so that the DLLs that reference CCNGA2D3 can be built.

The CCNGA2 application (Figure 88 on page 320) imports functions and variables from three DLLs: (Figure 89 on page 320, Figure 90 on page 321, and Figure 91 on page 321). It is an example of an application that uses DLLs that call each other.

---

```

#include <stdlib.h>

extern int var1_d1;          /*imported from CCNGA2D1 */
extern int func1_d1(int);   /*imported from CCNGA2D1 */

extern int var1_d2;          /*imported from CCNGA2D2 */
extern int func1_d2(int);   /*imported from CCNGA2D2 */

extern int var1_d3;          /*imported from CCNGA2D3 */
extern int func1_d3(int);   /*imported from CCNGA2D3 */

int main() {
    int rc = 0;

    printf("+CCNGA2::main() starting \n");
    /* ref DLL1 */
    if (var1_d1 == 100) {
        printf("| var1_d1=<%d>\n",var1_d1++);
        func1_d1(var1_d1);
    }
    /* ref DLL2 */

    if (var1_d2 == 200) {
        printf("| var1_d2=<%d>\n",var1_d2++);
        func1_d2(var1_d2);
    }
    /* ref DLL3 */
    if (var1_d3 == 300) {
        printf("| var1_d3=<%d>\n",var1_d3++);
        func1_d3(var1_d3);
    }

    printf("+CCNGA2::main() Ending \n");
}

```

---

*Figure 88. Application CCNGA2*

Figure 89 shows application CCNGA2D1, which imports functions from Figure 90 on page 321 and Figure 91 on page 321.

---

```

#include <stdio.h>

int func1_d1();          /* A function to be externalized */
int var1_d1 = 100;      /* export this variable */

extern int func1_d2(int); /*imported from CCNGA2D2 */
extern int func1_d3(int); /*imported from CCNGA2D3 */

int func1_d1 (int input)
{
    int rc2 = 0;
    int rc3 = 0;
    printf("| +-CCNGA2D1() func1_d1() starting. Input is %d\n", input);
    rc2 = func1_d2(200);
    rc3 = func1_d3(300);
    printf("| | func1_d1() d111 - rc2=<%d> rc3=<%d>\n", rc2,
rc3);
    printf("| +-CCNGA2D1() func1_d1() ending. \n");
}

```

---

*Figure 89. Application CCNGA2D1*

Figure 90 on page 321 shows application CCNGA2D2, which imports a function from Figure 91 on page 321.

---

```

#include <stdio.h>

int func1_d2();          /* A function to be externalized */
int var1_d2 = 200;

extern int func1_d3(int); /* import this function      */

int func1_d2 (int input)
{
    int rc3 =0;
    printf(" | | +-CCNGA2D2() func1_d2() starting. Input is %d\n",
input);
    rc3 = func1_d3(300);
    printf(" | | | func1_d2() d112 - rc3=<%d>\n", rc3);
    printf(" | | +-CCNGA2D2() func1_d2() ending\n");
}

```

---

*Figure 90. Application CCNGA2D2*

Application CCNGA2D3 (Figure 91) imports variables from Figure 89 on page 320 and Figure 90.

---

```

#include <stdio.h>

int func1_d3();          /* A function to be externalized */
int var1_d3 = 300;

extern int var1_d1;      /* imported variable from CCNGA2D1 */
extern int var1_d2;      /* imported variable from CCNGA2D2 */

int func1_d3 (int input)
{
    printf(" | | | +-CCNGA2D3()-func1_d3() starting. Input is %d\n",
input);
    printf(" | | | value of var1_d1=%d var1_d2=%d\n",
var1_d1, var1_d2);
    printf(" | | | +-CCNGA2D3()-func1_d3() ending\n");
}

```

---

*Figure 91. Application CCNGA2D3*

The first method uses the JCL in Figure 92 on page 322. The following processing occurs:

1. CCNGA2D3 is compiled and bound to create a DLL. The binder uses the control cards supplied through SYSIN to import variables from CCNGA2D1 and CCNGA2D2. The binder also generates a side-deck CCNGA2D3 that is used in the following steps.
2. CCNGA2D2 is compiled and bound to create a DLL. The binder uses the control cards supplied through SYSIN to include the side-deck from CCNGA2D3. The following steps use the binder which generates the side-deck CCNGA2D2.
3. CCNGA2D1 is compiled and bound to create a DLL. The binder uses the control cards supplied through SYSIN to include the side-decks from CCNGA2D2 and CCNGA2D3. The following steps show the binder generating the side-deck CCNGA2D1.
4. CCNGA2 is compiled, bound, and run. The binder uses the control statements supplied through SYSIN to include the side-decks from CCNGA2D1, CCNGA2D2, and CCNGA2D3.

---

```

//jobcard information...
//PROC JCLLIB ORDER=(CBC.SCCNPRC, CEE.SCEEPROC)
//*
//* CBDLL3: -Compile and bind CCNGA2D3
//* -Explicit import of variables from CCNGA2D1 and CCNGA2D2
//* -Generate the side-deck CCNGA2D3
//*
//CBDLL3 EXEC EDCCB,INFILE='CBC.SCCNSAM(CCNGA2D3)',
// CPARAM='SO,LIST,DLL,EXPO,RENT,LONG',
// OUTFILE='myid.LOAD,DISP=SHR'
//BIND.SYSIN DD *
IMPORT DATA CCNGA2D1 var1_d1
IMPORT DATA CCNGA2D2 var1_d2
NAME CCNGA2D3(R)
/*
//BIND.SYSDEFSD DD DSN=myid.IMPORT(CCNGA2D3),DISP=SHR
/*
/*CDDL2: -Compile and bind CCNGA2D2
/* -Include the side-deck CCNGA2D3
/* -Generate the side-deck CCNGA2D2
/*
//CBDLL2 EXEC EDCCB,INFILE='CBC.SCCNSAM(CCNGA2D2)',
// CPARAM='SO,LIST,DLL,EXPO,RENT,LONG',
// OUTFILE='myid.LOAD,DISP=SHR'
//BIND.SYSIN DD *
INCLUDE DSD(CCNGA2D3)
NAME CCNGA2D2(R)
/*
//BIND.SYSDEFSD DD DSN=myid.IMPORT(CCNGA2D2),DISP=SHR
//BIND.DSD DD DSN=myid.IMPORT,DISP=SHR
/*
/* CBDLL1: -Compile and bind CCNGA2D1
/* -Include the side-deck CCNGA2D2 and CCNGA2D3
/* -Generate the side-deck CCNGA2D1
/*
//CBDLL1 EXEC EDCCB,INFILE='CBC.SCCNSAM(CCNGA2D1)',
// CPARAM='SO,LIST,DLL,EXPO,RENT,LONG',
// OUTFILE='myid.LOAD,DISP=SHR'
//BIND.SYSIN DD *
INCLUDE DSD(CCNGA2D2)
INCLUDE DSD(CCNGA2D3)
NAME CCNGA2D1(R)
/*
//BIND.SYSDEFSD DD DSN=myid.IMPORT(CCNGA2D1),DISP=SHR
//BIND.DSD DD DSN=myid.IMPORT,DISP=SHR
/*
/* CBAPP2: -Compile, bind and run CCNGA2
/* -Include the side-deck CCNGA2D1, CCNGA2D2 and CCNGA2D3
/*
//CBAPP2 EXEC EDCCBG,INFILE='CBC.SCCNSAM(CCNGA2)',
// CPARAM='SO,LIST,DLL,RENT,LONG',
// OUTFILE='myid.LOAD(CCNGA2),DISP=SHR'
//BIND.SYSIN DD *
INCLUDE DSD(CCNGA2D1)
INCLUDE DSD(CCNGA2D2)
INCLUDE DSD(CCNGA2D3)
NAME CCNGA2(R)
/*
//BIND.DSD DD DSN=myid.IMPORT,DISP=SHR
//GO.STEPLIB DD
// DD DSN=myid.LOAD,DISP=SHR

```

---

*Figure 92. CCNGA2M1*

The second method uses the JCL in Figure 93 on page 323. The following processing occurs:

1. Once compiled, the object module CCNGA2D2 is saved for the following steps.
2. CCNGA2D1 is compiled, the object module is saved for the following steps.

3. CCNGA2D3 is compiled and bound to generate the side-deck and the object module is not used in the following steps. The load module for this step is not saved, as it is not being used. The load module for CCNGA2D3 is generated at a later step.
4. CCNGA2D2 is bound to create a DLL. The binder takes as input the object module CCNGA2D2 and the side-deck CCNGA2D3. It also generates the side-deck CCNGA2D2 that is used in the following steps.
5. CCNGA2D1 is bound to create a DLL. The binder takes as input the object module CCNGA2D1 and the side-decks CCNGA2D3 and CCNGA2D2. It also generates the side-deck CCNGA2D1 that is used in the following steps.
6. CCNGA2D3 is bound to create a DLL. The binder takes as input the object module CCNGA2D3 and the side-decks CCNGA2D1 and CCNGA2D2. It also generates the side-deck CCNGA2D3 that is used in the following step.
7. CCNGA2 is compiled, bound, and run. The binder takes as input the object module CCNGA2 and the side-decks CCNGA2D1, CCNGA2D2, and CCNGA2D3.

```

//jobcard information...
//PROC JCLLIB ORDER=(CBC.SCCNPRC, CEE.SCEEPROC)
//* CDLL2: -Compile CCNGA2D2
//*
//CDLL2 EXEC EDCC,INFILE='CBC.SCCNSAM(CCNGA2D2)',
// OUTFILE='myid.OBJ(CCNGA2D2),DISP=SHR',
// CPARM='SO,LIST,DLL,EXPO,RENT,LONG'
//*
//* CDLL1: -Compile CCNGA2D1
//*
//CDLL1 EXEC EDCC,INFILE='CBC.SCCNSAM(CCNGA2D1)',
// OUTFILE='myid.OBJ(CCNGA2D1),DISP=SHR',
// CPARM='SO,LIST,DLL,EXPO,RENT,LONG'
//*
//* CBDLL3: -Compile and bind CCNGA2D3 with NCAL
//* -Generate the side-deck CCNGA2D3
//* -The load module will not be kept, as it will not be
//* used
//*
//CBDLL3 EXEC EDCCB,INFILE='CBC.SCCNSAM(CCNGA2D3)',
// CPARM='SO,LIST,DLL,EXPO,RENT,LONG',
// BPARM='NCAL'
//COMPILE.SYSLIN DD DSN=myid.OBJ(CCNGA2D3),DISP=SHR
//BIND.SYSLIN DD DSN=myid.OBJ(CCNGA2D3),DISP=SHR
//BIND.SYSIN DD *
INCLUDE OBJ(CCNGA2D2)
INCLUDE OBJ(CCNGA2D1)
NAME CCNGA2D3(R)
/*
//BIND.SYSDEFSD DD DSN=myid.IMPORT(CCNGA2D3),DISP=SHR
//BIND.OBJ DD DSN=myid.OBJ,DISP=SHR
/*

```

*CCNGA2M2 (Part 1 of 2)*

*Figure 93. CCNGA2M2*

```

/**
/** BDLL2: -Bind CCNGA2D2
/** -Generate the side-deck CCNGA2D2
/**
/**
//BDLL2 EXEC CBCB,INFILE='myid.OBJ(CCNGA2D2)',
// BPARM='CALL',
// OUTFILE='myid.LOAD(CCNGA2D2),DISP=SHR'
//BIND.SYSIN DD DSN=myid.IMPORT(CCNGA2D3),DISP=SHR
//BIND.SYSDEFSD DD DSN=myid.IMPORT(CCNGA2D2),DISP=SHR
/**
/**
/** BDLL1: -Bind CCNGA2D1
/** -Generate the side-deck CCNGA2D1
/**
/**
//BDLL1 EXEC CBCB,INFILE='myid.OBJ(CCNGA2D1)',
// BPARM='CALL',
// OUTFILE='myid.LOAD(CCNGA2D1),DISP=SHR'
//BIND.SYSIN DD *
INCLUDE DSD(CCNGA2D2)
INCLUDE DSD(CCNGA2D3)
/*
//BIND.SYSDEFSD DD DSN=myid.IMPORT(CCNGA2D1),DISP=SHR
//BIND.DSD DD DSN=myid.IMPORT,DISP=SHR
/**
/** BDLL3: -Bind CCNGA2D3
/** -Generate the side-deck CCNGA2D3
/**
/**
//BDLL3 EXEC CBCB,INFILE='myid.OBJ(CCNGA2D3)',
// BPARM='CALL',
// OUTFILE='myid.LOAD(CCNGA2D3),DISP=SHR'
//BIND.SYSIN DD *
INCLUDE DSD(CCNGA2D1)
INCLUDE DSD(CCNGA2D2)
NAME CCNGA2D3(R)
/*
//BIND.SYSDEFSD DD DSN=myid.IMPORT(CCNGA2D3),DISP=SHR
//BIND.DSD DD DSN=myid.IMPORT,DISP=SHR
/**
/** CBAPP2: -Compile, bind and run CCNGA2
/** -Input the side-decks CCNGA2D1, CCNGA2D2 and CCNGA2D3
/**
//CBAPP2 EXEC EDCCBG,INFILE='CBC.SCCNSAM(CCNGA2)',
// CPARM='SO,LIST,DLL,RENT,LONG',
// OUTFILE='myid.LOAD(CCNGA2),DISP=SHR'
//BIND.SYSIN DD *
INCLUDE DSD(CCNGA2D1)
INCLUDE DSD(CCNGA2D2)
INCLUDE DSD(CCNGA2D3)
NAME CCNGA2(R)
/*
//BIND.DSD DD DSN=myid.IMPORT,DISP=SHR
//GO.STEPLIB DD
// DD DSN=myid.LOAD,DISP=SHR

```

*CCNGA2M2 (Part 2 of 2)*

---

## Chapter 23. z/OS 64-bit environment

Implementation of the 64-bit environment has not changed the default behavior of the compiler; the default compilation environment is 32-bit, which is specified by the ILP32 compiler option.

The compiler changes the behavior of code only when compiling for the 64-bit environment, which is specified by the LP64 compiler option.

---

### Differences between the ILP32 and LP64 environments

The ILP32 and LP64 environments are differentiated by:

- Addressing capability
- Data model

#### ILP32 and LP64 addressing capabilities

Table 49 shows the differences in addressing capabilities that are available in each environment. 31-bit refers to the addressing mode, or AMODE. In z/OS XL C/C++, pointer sizes in this mode are always 4 bytes. In AMODE 31, 31 bits of the pointer are used to form the address, which is defined by the term “31-bit addressing mode”. Occasionally, we also use the term “32-bit mode”. Strictly speaking, 31-bit is an architectural characteristic referring to the addressing capability, while 32-bit is a programming language aspect referring to the data model. The latter is also referred to as ILP32 (int-long-pointer 32). When there is no ambiguity, we use the term “32-bit mode”.

Table 49. Comparison of ILP32 and LP64 addressing capabilities

ILP32 (32-bit environment)	LP64 (64-bit environment)
2 GB of address space	1 million TB of address space
31-bit execution mode <b>1</b>	64-bit execution mode

#### ILP32 and LP64 data models and data type sizes

Table 50 compares data models and data type sizes of ILP32 and LP64 environments.

Table 50. Comparison of ILP32 and LP64 data models

ILP32 (32-bit environment)	LP64 (64-bit environment)
Data model ILP32 (32-bit pointer)	Data model LP64 (64-bit pointer)
int, long, ptr, and off_t are all 32 bits (4 bytes) in size.	int is 32 bits in size. long, ptr, and off_t are all 64 bits (8 bytes) in size.

The 32-bit data model for z/OS XL C/C++ compilers is ILP32 plus long long. This data model uses the 4/4/4 data type size model and includes a long long type. Table 51 on page 326 compares the type sizes for the different models.

LP64 is the 64-bit data model chosen by the Aspen working group (formed by X/OPEN and a consortium of hardware vendors). LP64 is short for long-pointer



64. It is commonly referred to as the 4/8/8 data type size model and includes the integer/long/pointer type sizes, measured in bytes.

Table 51. ILP32 and LP64 type size comparisons for signed and unsigned data types

Data Type	32-bit sizes (in bytes)	64-bit sizes (in bytes)	Remarks
char	1	1	
short	2	2	
int	4	4	
long	4	8	
long long	8	8	
float	4	4	
double	8	8	
long double	16	16	
pointer	4	8	
wchar_t	2	4	Other UNIX platforms usually have wchar_t 4 bytes for both 32-bit and 64-bit mode.
size_t	4	8	This is an unsigned type.
ptrdiff_t	4	8	This is a signed type.

---

## Advantages and disadvantages of the LP64 environment

A major advantage of using a 64-bit environment is the increase in the virtual addressing space. A 64-bit program can handle large tables as arrays without putting temporary files in secondary storage. LP64 provides:

- 64-bit addressing with 8-byte pointers
- Large object support (8-byte longs)
- Backward compatibility (4-byte integers)

**Note:** Integers are the same size under the ILP32 and LP64 data models.

## LP64 application performance and program size

You can use the 64-bit address space to dramatically improve the performance of applications that manipulate large amounts of data, whether the data is be created within the application or obtained from files. Generally, the performance gain comes from the fact that the 64-bit application can contain the data in its 64-bit address space (either created in data structures or mapped into memory), when it would not have fit into a 32-bit address space. The data would need to be multiple GBs in size or larger to show this benefit.

If the same source code is used to create a 32-bit and a 64-bit application, the 64-bit application will typically be larger than the 32-bit application. The 64-bit application is unlikely to run faster than the 32-bit application unless it makes use of the larger 64-bit addressability. Because most C programs are pointer-intensive, a 64-bit application can be close to twice as large as a 32-bit application, depending on how many global pointers and longs are declared. A 64-bit C++ program uses almost twice the data as a 32-bit C++ program, due to the large number of pointers the compiler uses to implement virtual function tables, objects, templates, and so

on. That is why the appropriate choice is to create a 32-bit application, unless 64-bit addressability is required by the application or can be used to dramatically improve its performance.

**Attention:** Even though the address space is increased significantly, the amount of hardware physical memory is still limited by your installation. Data that is not immediately required by the program is subject to system paging. Programs that use large data tables therefore require a large amount of paging space. For example, if a program requires 3 GB of address space, the system must have 3 GB of paging space. 64-bit applications might require paging I/O tuning to accommodate the large data handling benefit.

## LP64 restrictions

The following restrictions apply under LP64:

- The ILP32 statement `type=memory(hiperspace)` is treated as `type=memory` under LP64.

Hiperspace memory files are treated as regular memory files in a 64-bit environment. All behavior is the same as for regular memory files.

- The IMS and CICS environments are not supported under LP64. References to these environments are valid under ILP32 only.
- User-supplied buffers are ignored for all but UNIX file system files under LP64. References to user-supplied buffers are valid under ILP32 only.
- Under 64-bit data models, pointer sizes are always 64 bits.

The C Standard does not provide a mechanism for specifying mixed pointer size. However, it might be necessary to specify the size of a pointer type to help migrate a 32-bit application (for example, when libraries share a common header between 32-bit and 64-bit applications).

---

## Migrating applications from ILP32 to LP64

This section describes:

- When to migrate applications to LP64
- Pre-migration checklist
- Post-migration checklist

### When to migrate applications to LP64

The LP64 strategy is to strike a balance between maximizing the robustness of 64-bit capabilities while minimizing the effort of migrating many programs.

Typically, a 32-bit application should be ported only if either of the following is true:

- It is required by a DLL or a supporting utility
- It must have 64-bit addressability

This is because:

- Porting programs to a 64-bit environment presents a modest technical effort where good coding practices are used. Poor coding practices greatly increase the programming effort.
- There is no clear performance advantage to recompiling an existing 32-bit program in 64-bit mode. In fact, a small slowdown is possible. This is due to:
  - An increase in module size because instructions are larger

- An increase in size of the writable static area (WSA) and the stack because pointers and longs are larger
- Issues related to runtime requirements (for example, when you port a program that is compiled with NORENT and NODLL to a 64-bit environment, you must code the program to use the RENT and DLL options, which are required in the 64-bit environment)

## Checklist for ILP32-to-LP64 pre-migration activities

Use the following checklist prior to migrating an application from ILP32 to LP64. After migration, test the code and confirm that its behavior is the same under LP64 as it was under ILP32. If you see any difference, debug the code and use the checklist again.

1. Search the source code for patterns that might indicate migration issues. These include:
  - printf specifiers that involve long data types
  - 0xffffffff
  - 2147483647
2. Verify that all functions are properly prototyped.

**Note:** The C compiler assumes that an unprototyped function returns the int type. This could cause undesirable behavior under LP64 while remaining undetectable under ILP32.

3. Examine all types to determine whether the types should be 4-byte or 8-byte.
  - For system types, the type will be the appropriate size for use with library/system calls.
  - For user-defined types:
    - 4-byte types should be defined based upon int or unsigned int or some system type that is 4 bytes long under LP64.
    - 8-byte types should be defined based upon long or unsigned long or some system type that is 8 bytes long.
4. Change all types to the chosen type.

**Note:** When doing so, examine all arithmetic calculations to make sure that expansion and truncation of data values is done appropriately. Make sure that no assumption is made that pointer values will fit into integer types.

5. Use the INFO compiler option to identify the following potential problems:
  - Functions not prototyped - Function prototypes allow the compiler to check for mismatched parameters.
  - Functions not prototyped - Return parameter mis-matched, especially when the code expects a pointer. (For example, malloc and family)
  - Assignment of a long or a pointer to an int - This type of assignment could cause truncation. Even assignments with an explicit cast will be flagged.
  - Assignment of an int to a pointer - If the pointer is referenced it might be invalid.

## Checklist for ILP32-to-LP64 post-migration activities

After migrating a program, test the code and confirm that its behavior is the same under LP64 as it was under ILP32. Use the following checklist to test the code. If you see any difference, debug the code and use the pre-migration checklist again.

1. Verify that all output produced is contained in the 4-byte range.

If this is not possible, then any other application using this data needs to be ported to LP64 or, at least, be made 8-byte-aware.

2. Verify that any user-provided process containing the `wchar_t` type definition did not produce unexpected results.

UNIX `wchar_t` data types are typically defined as four bytes under both 32-bit and 64-bit environments. *The size difference applies to the ILP32 model, not the LP64 model.* The new environment was an opportunity to increase the size for future development. Because `wchar_t` is a type definition, user-provided methods are a likely problem area. A carefully-written application should not require changes.

---

## Using compiler diagnostics to ensure portability of code

This section describes:

- Using the `INFO` option to ensure that numbers are suffixed
- Using the `WARN64` option to identify potential portability problems

### Using the `INFO` option to ensure that numbers are suffixed

The `INFO C` and `C++` option provides general diagnostics about program code and is not specific to migrations from ILP32 to LP64. Before migrating, use the appropriate option to ensure that the following items have been expunged from the code:

- Functions not prototyped - Function prototypes allow the compiler to check for mismatched parameters.
- Functions not prototyped - Return parameter mis-matched, especially when the code expects a pointer. (For example, `malloc` and family)
- Assignment of a long or a pointer to an `int` - This type of assignment could cause truncation. Even assignments with an explicit cast will be flagged.
- Assignment of an `int` to a pointer - If the pointer is referenced it might be invalid.

Table 52. Example of diagnostic messages generated from code that is not ready to be migrated from ILP32 to LP64

<b>Source:</b>	<pre>1 #include &lt;stdio.h&gt; 2 #include &lt;limits.h&gt; 3 4 void main(void) { 5     int foo_i; 6     long foo_l; 7     int *foo_pt; 8 9     foo_l = boo(1); 10    foo_l = foo_l &lt;&lt; 1; 11    foo_l = 0xFFFFFFFF; 12    foo_l = (foo_l &amp; 0xFFFFFFFF); 13    foo_l = LONG_MAX; 14    foo_l = (long)foo_i; 15    foo_i = (int) &amp;foo_l; 16 17    foo_pt = (int *)foo_i; 18 } 19 long boo(long boo_l) { 20     return(boo_l); 21 }</pre>
----------------	--

Table 52. Example of diagnostic messages generated from code that is not ready to be migrated from ILP32 to LP64 (continued)

<b>Output:</b>	<pre> WARNING CCN3304 sample.c:9 No function prototype was given for boo. INFORMATIONAL CCN3419 sample.c:11 Converting 4294967295 to type long int does not preserve its value. INFORMATIONAL CCN3438 sample.c:14 The value of the variable foo_i may be used before being set. INFORMATIONAL CCN3491 sample.c:17 The automatic variable foo_pt is set but never referenced. WARNING CCN3343 sample.c:19 Redeclaration of boo differs from the declaration on line 9 of /home/ts43218/sample2.c. INFORMATIONAL CCN3050 sample.c:19 Return type long in the redeclaration is not compatible with the previous return type int. INFORMATIONAL CCN3470 sample.c:21 Function main should return int, not void. </pre>
<b>Note:</b> Lines 9,11 and 14 are affected by porting the code to LP64.	

## Using the WARN64 option to identify potential portability problems

Under ILP32, both `int` and `long` data types are 32 bits in size. Because of this coincidence, these types might have been used interchangeably. As shown in Table 51 on page 326, the data type `long` is 8 bytes in length under LP64.

A general guideline is to review the existing use of `long` data types throughout the source code. If the values to be held in such variables, fields, and parameters will fit in the range of  $[-231 \dots 231-1]$  or  $[0 \dots 232-1]$ , then it is probably best to use `int` or `unsigned int` instead. Also, review the use of the `size_t` type (used in many subroutines), since its type is defined as `unsigned long`.

When you migrate a program from ILP32 to LP64, the data model differences might result in unexpected behavior at execution time. Under LP64, the size of pointers and `long` data types are 8 bytes, which can lead to conversion or truncation problems. The `WARN64` option can be used to detect these portability errors.

The `WARN64` option provides general diagnostics about program code that might behave differently under ILP32 and LP64. However the checking is not exhaustive. Use it to look for potential migration problems, such as the following common problems:

- Truncation due to explicit or implicit conversion of `long` types into `int` types
- Unexpected results due to explicit or implicit conversion of `int` types into `long` types
- Invalid memory references due to explicit conversion by cast operations of pointer types into `int` types
- Invalid memory references due to explicit conversion by cast operations of `int` types into pointer types
- Problems due to explicit or implicit conversion of constants into `long` types
- Problems due to explicit or implicit conversion by cast operations of constants into pointer types

There are a few problems that WARN64 cannot find. For example, unions that use longs or pointers that work under ILP32 might not work under LP64 .

```
union {
    int *p; /* 32 bits / 64 bits */
    int i; /* 32 bits / 32 bits */
};

union {
    double d; /* 64 bits / 64 bits */
    long l[2]; /* 64 bits / 128 bits */
};
```

---

## ILP32-to-LP64 portability issues

Before migrating applications, consider the following:

- The sizes of the long, pointer and wchar\_t types are different under LP64 than they are under ILP32. You must check application behavior, especially if the logic depends on data size.
- Data model differences can result in unexpected behavior at execution time. Under LP64, the size of pointers and long data type are 8 bytes long. This can lead to conversion or truncation problems.

**Note:** You can use the WARN64 option to help detect these portability errors. See “Using the WARN64 option to identify potential portability problems” on page 330.

- A migration issue can exist if the program assumes that int, long and pointer type are all the same size. The number of cases where program logic relies on this assumption varies from application to application, depending on the coding style and functionality of the application.

**Note:** Most unexpected behaviors occur at the limits of a type's value range.

- 32-bit applications that rely implicitly on internal data representations (for example, those that cast a float pointer to an integer pointer, then manipulate the bit patterns directly and encode such knowledge directly into the program logic) can be difficult to migrate. In this case, certain assumptions are made about the internal structure of a float representation and the size of int.
- Code must be checked to ensure that any shifting and masking operations that manipulate long integers still work properly with a 64-bit long.
- Input and output file dependencies are relevant when you migrate an application that is in the middle of a pipeline of applications, where each application reads the previous application's output as input, and then passes its output to the next application in the pipe. Before migrating one of these applications to a 64-bit environment, you must verify that the output will not produce values outside of the 32-bit range. Typically, once an application is ported to a 64-bit environment, all downstream applications (that is, any application that depends on output from the ported application) must be ported to a 64-bit environment.
- Extending functions is sometimes included as part of a migration project to exploit the benefit and to justify the cost of migrating to a 64-bit environment. You might have to change code for using expanded limits after extending functions.

- You cannot mix 32-bit and 64-bit object files during binding. The only object file format supported under LP64 bit is GOFF, and the only linkage convention is XPLINK.

## IPA(LINK) option and exploitation of 64-bit virtual memory

As of z/OS V1R8 XL C/C++, IPA(LINK) makes use of 64-bit virtual memory, which will cause an XL C/C++ compiler ABEND if there is insufficient storage. The default MEMLIMIT system parameter size in the SMFPRMx parmlib member should be at least 3000 MB. The default MEMLIMIT value takes effect whenever the job does not specify one of the following:

- MEMLIMIT in the JCL JOB or EXEC statement
- REGION=0 in the JCL

**Note:** The MEMLIMIT value specified in an IEFUSI exit routine overrides all other MEMLIMIT settings.

The z/OS UNIX System Services **ulimit** command can be used to set the MEMLIMIT default. For information, see *z/OS UNIX System Services Command Reference*. For additional information about the MEMLIMIT system parameter, see *z/OS MVS Programming: Extended Addressability Guide*.

As of z/OS V1R8 XL C/C++, the EDCI, EDCXI, EDCQI, CBCI, CBCXI, and CBCQI cataloged procedures, which are used for IPA Link, contain the variable IMEMLIM, which can be used to override the default MEMLIMIT value.

## Availability of suboptions

Table 53 shows a comparison of the compiler and runtime options that are available in each environment. For example, if you are developing a program to run in either a 32-bit or a 64-bit environment, you must code it to ensure that the high-performance linkage (XPLINK) option is in effect regardless of whether the program is running under ILP32 or LP64.

*Table 53. Comparison of ILP32 and LP64 processing and runtime options*

ILP32 (32-bit environment)	LP64 (64-bit environment)
XPLINK or non-XPLINK	XPLINK only
32-bit dynamic linked libraries (DLLs)	64-bit DLLs

## Potential changes in structure size and alignment

The LP64 specification changes the size and alignment of certain structure elements, which affects the size of the structure itself. In general, all structures that use long integers and pointers must be checked for size and alignment dependencies.

It is not possible to share a data structure between 32-bit and 64-bit processes, unless the structure is devoid of pointer and long types. Unions that attempt to share long and int types (or overlay pointers onto int types) will be aligned differently or will be corrupted. For example, the virtual function table pointer, inherent in many C++ objects, is a pointer and will change the size and alignment of many C++ objects. In addition, the size and composition of the compiler-generated virtual function table will change.



**Note:** The issue of changing structure size and alignment should not be a problem unless the program makes assumptions about the size and/or composition of structures.

### **z/OS basic rule of alignment**

The basic rule of alignment in z/OS is that a data structure is aligned in accordance with its size and the strictest alignment requirement for its largest member. An 8-byte alignment is more stringent than a 4-byte alignment. In other words, members that can be placed on a 4-byte boundary can also be placed on an 8-byte boundary, but not vice versa.

**Note:** The only exception is a long double, which is always aligned on an 8-byte boundary.

You can satisfy the rule of alignment by inserting pad members both between members and at the end of a structure, so that the overall size of the structure is a multiple of the structure's alignment.

### **Examples of structure alignment differences under ILP32 and LP64**

This section provides examples of three structures that illustrate the impact of the ILP32 and LP64 programming environments on structure size and alignment.

In accordance with the z/OS rule of alignment (see “z/OS basic rule of alignment”), the length of each data member produced by the source code depends on the runtime environment, as shown in Table 54.

*Table 54. Comparison of data structure member lengths produced from the same code*

<b>Source:</b>	<pre>#include &lt;stdio.h&gt;  int main(void) {     struct li{         long la;         int ia;     } li;     struct lii{         long la;         int ia;         int ib;     } lii;     struct ili{         int ia;         long la;         int ib;     } ili;     printf("length li = %d\n",sizeof(li));     printf("length lii = %d\n",sizeof(lii));     printf("length ili = %d\n",sizeof(ili)); }</pre>
<b>ILP32 member lengths:</b>	<pre>length li = 8 <b>1</b> length lii = 12 <b>3</b> length ili = 12 <b>3</b></pre>
<b>LP64 member lengths:</b>	<pre>length li = 16 <b>2</b> length lii = 16 <b>3</b> length ili = 24 <b>3</b></pre>



Table 54. Comparison of data structure member lengths produced from the same code (continued)

<p><b>Notes:</b></p> <ol style="list-style-type: none"><li>1. In a 32-bit environment, both <code>int</code> and <code>long int</code> have 4-byte alignments, so each of these members is aligned on 4-byte boundary. In accordance with the z/OS rule of alignment, the structure as a whole has a 4-byte alignment. The size of <code>struct li</code> is 8 bytes. See Figure 94 on page 335.</li><li>2. In a 64-bit environment, <code>int</code> has a 4-byte alignment and <code>long int</code> has an 8-byte alignment. In accordance with the z/OS rule of alignment, the structure as a whole has an 8-byte alignment. See Figure 94 on page 335.</li><li>3. The <code>struct lii</code> and the <code>struct ili</code> have the same members, but in a different member order. See Figure 95 on page 336 and Figure 96 on page 337. Because of the padding differences in each environment:<ul style="list-style-type: none"><li>• Under ILP32:<ul style="list-style-type: none"><li>– The size of <code>struct lii</code> is 12 bytes (4-byte long + 4-byte int + 4-byte int)</li><li>– The size of <code>struct ili</code> is 12 bytes (4-byte int + 4-byte long + 4-byte int)</li></ul></li><li>• Under LP64:<ul style="list-style-type: none"><li>– The size of <code>struct lii</code> is 16 bytes (8-byte long + 4-byte int + 4-byte int)</li><li>– The size of <code>struct ili</code> is 24 bytes (4-byte int + 4-byte pad + 8-byte long + 4-byte int + 4-byte pad)</li></ul></li></ul></li></ol>
---

The ILP32 and LP64 alignments for the structs defined by the code shown in Table 54 on page 333 are compared in Figure 94 on page 335, Figure 95 on page 336, and Figure 96 on page 337.

Figure 94 on page 335 compares how `struct li` is aligned under ILP32 and LP64. The structure has two members:

- The first (member `la`) is of type `long`
- The second (member `ia`) is of type `int`

Under ILP32, each member is 4 bytes long and is aligned on a 4-byte boundary, making the structure 8 bytes long. Under LP64, member `la` is 8 bytes long and is aligned on an 8-byte boundary. Member `ia` is 4 bytes long, so the compiler inserts 4 padding bytes to ensure that the structure is aligned to the strictest alignment requirement for its largest member. Then, the structure can be used as part of an array under LP64.

**ILP32****LP64**

Figure 94. Comparison of `struct li`, alignments under ILP32 and LP64

Figure 95 on page 336 and Figure 96 on page 337 show structures that have the same members, but in a different order. Compare these figures to see how the order of the members impacts the size of the structures in each environment.

Figure 95 on page 336 compares how `struct lii` is aligned under ILP32 versus LP64. `struct lii` has three members:

- The first (member `la`) is of type `long`
- The second (member `ia`) and third (member `ib`) are of type `int`

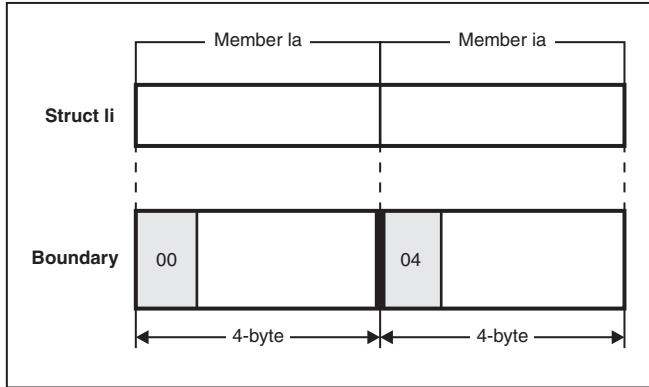
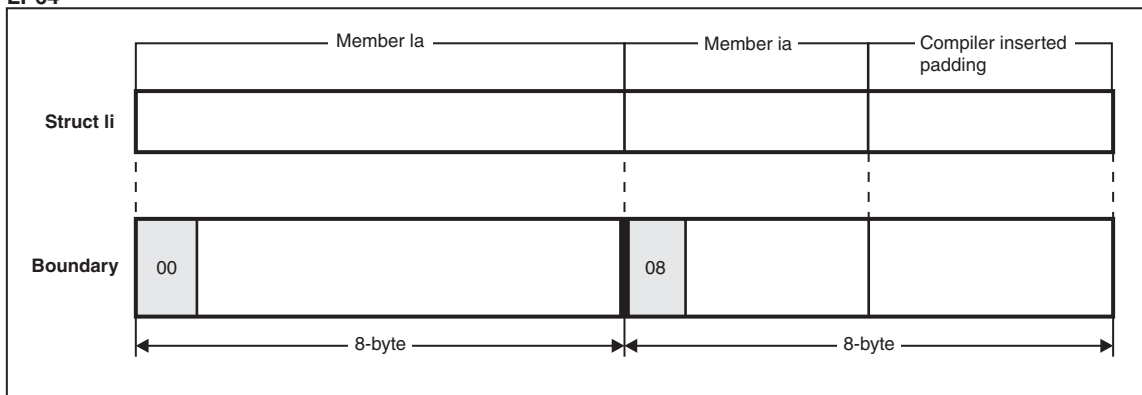
Under ILP32, each member is 4 bytes long and is aligned on a 4-byte boundary, making the structure 12 bytes long. Under LP64, member `la` is 8 bytes long and is aligned on an 8-byte boundary. Member `ia` and member `ib` are each 4 bytes long, so the structure is 16 bytes long and can align on an 8-byte boundary without padding.

**ILP32****LP64**

Figure 95. Comparison of `struct lli` alignments under ILP32 and LP64

Figure 96 on page 337 compares how `struct ili` is aligned under ILP32 and LP64. `struct ili` has three members:

- The first (member `ia`) is of type `int`
- The second (member `la`) is of type `long`
- The third (member `ib`) is of type `int`

Under ILP32, each member is 4 bytes long and is aligned on a 4-byte boundary, making the structure 12 bytes long. Under LP64, the compiler inserts padding after both member `ia` and member `ib`, so that each member with padding is 8 bytes long (member `la` is already 8 bytes long) and are aligned on 8-byte boundaries. The structure is 24 bytes long.

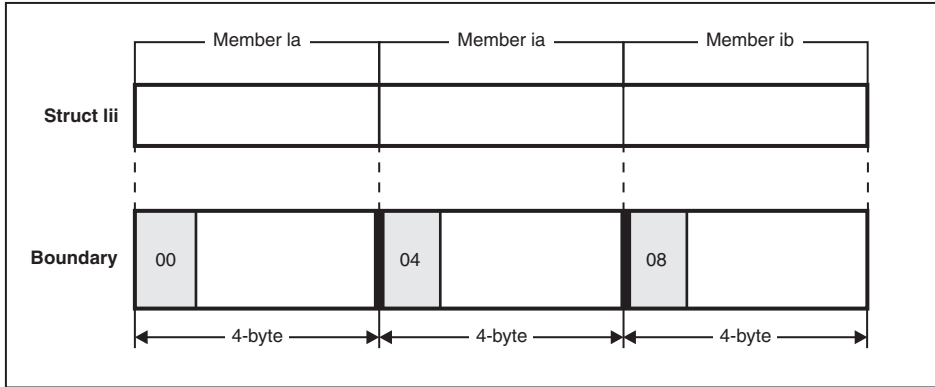
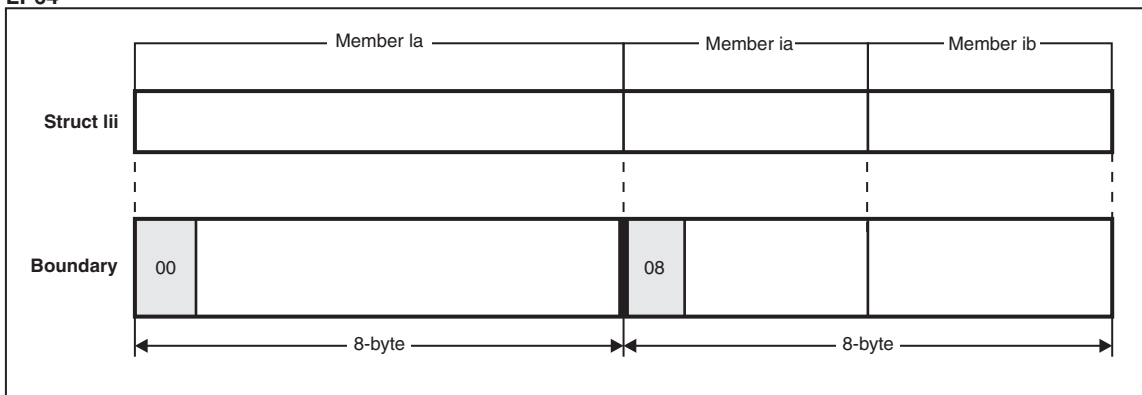
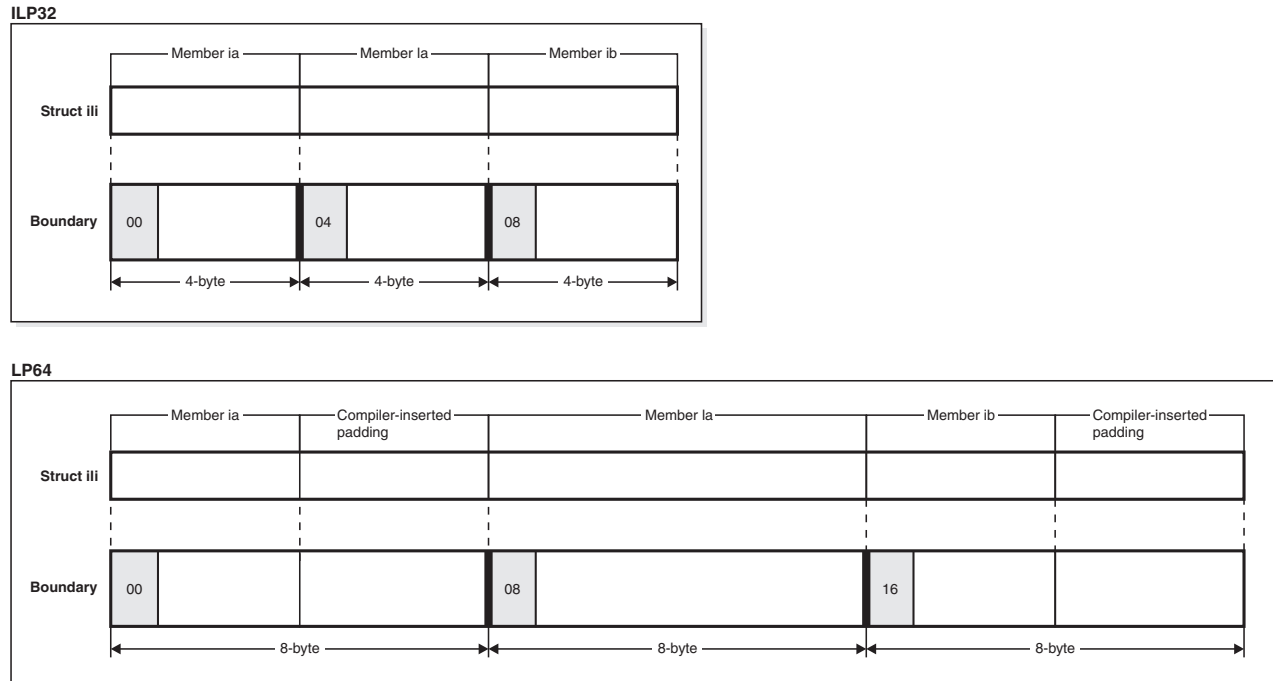

Figure 96. Comparison of struct ili alignments under ILP32 and LP64

## Data type assignment differences under ILP32 and LP64

Under ILP32, int, long and pointer types have the same size and can be freely assigned to one another.

Under LP64, all pointer types are 8 bytes in size. Assigning pointers to int types and back again can result in a invalid address, and passing pointers to a function that expects an int type will result in truncation. For example, the following statement show an incorrect assignment.

```
int i;
int *p;
i = (int)p;
```

**Note:** The problem is harder to detect when casts are used. Although there is no warning message, the problem still exists.

Avoid making any of the following assumptions:

- A pointer type or a C long type can fit into a C integer type.
- A type that is derived from a pointer type can fit into a type derived from an integer type.
- The number of bits in a C long type object is assumed, especially when shifting bits or doing bitwise operations.
- A C integer can be passed to an unprototyped long or pointer parameter.
- A function that is not a prototype can return a pointer or long.

## Portability issues with data types long and int

Under LP64, types long and int are not interchangeable. The long type (and types derived from it) is 64 bits in size.

You should consider all types related to the long and unsigned long types. For example, size\_t, used in many subroutines, is defined under LP64 as unsigned long.

Because of the difference in size for int and long under LP64, conversions to long from other integral types might be executed differently than it was under ILP32.

**Example of possible change of result after conversion from signed number to unsigned long:** When a signed char, signed short, or signed int is converted to unsigned long, sign extension might result in a different unsigned value in 64-bit mode. The example in Table 55 will yield 4294967295 (0xffffffff) under ILP32 but 18446744073709551615 (0xffffffffffffffff) under LP64, because of sign extension.

Table 55. Example of possible change of result after conversion from signed number to unsigned long

<b>Source:</b>	<pre>#include&lt;stdio.h&gt; void foo(int i) {     unsigned long l = i;     printf("%lu (0x%x)\n", l, l); } void main() {     foo(-1); }</pre>
<b>Compiler options:</b>	<code>cc -Wc,"flag(i),warn64" -c warn2.c</code>
<b>Output:</b>	INFORMATIONAL CCN3743 ./warn2.c:4 64-bit portability: possible change of result through conversion of int type into unsigned long int type.

**Example of possible change of result after conversion from unsigned int variable to signed long:** When an unsigned int variable with values greater than INT\_MAX is converted to signed long, the results depend on whether the application is executed under ILP32 or under LP64. In the example in Table 56:

- Under ILP32, the value INT\_MAX+1 will wrap around and yield -2147483648 (0x80000000)
- Under LP64, the value INT\_MAX+1 can be represented by an 8-byte signed long and will result in the correct value 2147483648 (0x80000000)

Table 56. Example of possible change of result after conversion from unsigned int variable to signed long

<b>Source:</b>	<pre>#include&lt;stdio.h&gt; #include&lt;limits.h&gt; void foo(unsigned int i) {     long l = i;     printf("%ld (0x%x)\n", l, l); } void main() {     foo(INT_MAX + 1); }</pre>
----------------	--

Table 56. Example of possible change of result after conversion from unsigned int variable to signed long (continued)

<b>Compiler options:</b>	cc -Wc,"flag(i),warn64" -c warn3.c
<b>Output:</b>	INFORMATIONAL CCN3743 ./warn3.c:5 64-bit portability: possible change of result through conversion of unsigned int type into long int type.

**Example of possible change of result after conversion from signed long long variable to signed long:** When a signed long long variable with values either greater than U\_INT\_MAX or less than 0 is converted to unsigned long, truncation will not occur under LP64. The example in Table 57 will yield:

- 4294967295 (0xffffffff) 0 (0x0) under ILP32
- 18446744073709551615 (0xffffffffffffff) 4294967296 (0x100000000) under LP64

Table 57. Example of possible change of result after conversion from signed long long variable to signed long

<b>Source:</b>	<pre>#include&lt;stdio.h&gt; #include&lt;limits.h&gt; void foo(signed long long ll) {     unsigned long l = ll;     printf("%lu (0x%x)\n", l, l); } void main() {     foo(-1);     foo(U_INT_MAX + 111); }</pre>
<b>Compiler options:</b>	cc -Wc,"flag(i),warn64" -c warn4.c
<b>Output:</b>	INFORMATIONAL CCN3743 ./warn4.c:564-bit portability: possible change of result through conversion of long long int type into unsigned long int type.

**Example of possible change of result after conversion from unsigned long long variable to unsigned long:** Under LP64, when an unsigned long long variable with values greater than U\_INT\_MAX is converted to unsigned long, truncation will not occur.

Table 58. Example of possible change of result after conversion from unsigned long long variable to unsigned long

<b>Source:</b>	<pre>#include&lt;stdio.h&gt; #include&lt;limits.h&gt; void foo(unsigned long long ll) {     unsigned long l = ll;     printf("%ld (0x%x)\n", l, l); } void main() {     foo(U_INT_MAX + 1ull); }</pre>
<b>ILP32 output:</b>	0 (0x0)  <b>Note:</b> The higher order word is truncated.

Table 58. Example of possible change of result after conversion from unsigned long long variable to unsigned long (continued)

<b>LP64 output:</b>	4294967296 (0x100000000)
	<b>Note:</b> There is no truncation.

**Example of possible change of result after conversion from signed long long variable to signed long:** Under LP64, when a signed long long variable with values less than INT\_MIN or greater than INT\_MAX is converted to signed long, truncation does not occur.

Table 59. Example of possible change of result after conversion from signed long long variable to signed long

<b>Source:</b>	<pre>#include&lt;stdio.h&gt; #include&lt;limits.h&gt; void foo(signed long long ll) {     signed long l = ll;     printf("%ld (0x%lx)\n", l, l); } void main() {     foo(INT_MIN - 111);     foo(INT_MAX + 111); }</pre>
<b>Compiler options:</b>	cc -Wc,"flag(i),warn64" -c warn5.c
<b>ILP32 output:</b>	<p>INFORMATIONAL CCN3743 ./warn5.c:5 64-bit portability: possible change of result through conversion of long long int type into long int type.</p> <p>2147483647 (0x7fffffff) -2147483648 (0x80000000)</p> <p><b>Note:</b> The higher order word is truncated.</p>
<b>LP64 output:</b>	<p>INFORMATIONAL CCN3743 ./warn5.c:5 64-bit portability: possible change of result through conversion of long long int type into long int type.</p> <p>-2147483649 (0xffffffff7fffffff) 2147483648 (0x80000000)</p> <p><b>Note:</b> There is no truncation.</p>

**Example of possible change of result after conversion from unsigned long long variable to signed long:** Under LP64, when an unsigned long long variable with values greater than INT\_MAX is converted to signed long, truncation does not occur.

Table 60. Example of possible change of result after conversion from unsigned long long variable to signed long

<b>Source:</b>	<pre>#include&lt;stdio.h&gt; #include&lt;limits.h&gt; void foo(unsigned long long ll) {     signed long l = ll;     printf("%ld (0x%lx)\n", l, ll); } void main() {     foo(INT_MAX + 1ull); }</pre>
<b>Compiler options:</b>	cc -Wc,"flag(i),warn64" -c warn6.c
<b>ILP32 output:</b>	<p>INFORMATIONAL CCN3743 ./warn6.c:5 64-bit portability: possible change of result through conversion of unsigned long long int type into long int type.</p> <p>-2147483648 (0x80000000)</p> <p><b>Note:</b> The value INT_MAX+1ull will wrap around.</p>
<b>LP64 output:</b>	<p>INFORMATIONAL CCN3743 ./warn6.c:5 64-bit portability: possible change of result through conversion of unsigned long long int type into long int type.</p> <p>2147483648 (0x80000000)</p> <p><b>Note:</b> The value INT_MAX+1ull can be represented by an 8-byte signed long and will result in the correct value.</p>

## Pointer declarations when 32-bit and 64-bit applications share header files

In 64-bit data models, pointer sizes are always 64 bits. There is no standard language syntax for specifying mixed pointer size. However, it might be necessary to specify the size of a pointer type to help migrate a 32-bit application (for example, when libraries share a common header between 32-bit and 64-bit applications).

The z/OS XL C/C++ compiler reserves two pointer size qualifiers:

- `__ptr32`
- `__ptr64`

The size qualifier `__ptr64` is not currently used; it is reserved so that a program cannot use it. The size qualifier `__ptr32` declares a pointer to be 32 bits in size. This is ignored under ILP32.

Examples of pointer declarations that can be made under LP64:

```
int * __ptr32 p; /* 32-bit pointer */ 1, 3
int * r;        /* 64-bit pointer, default to the model's size */ 4
int * __ptr32 const q; /* 32-bit const pointer */ 1, 2, 3
```

### Notes:

1. The qualifier qualifies the '\*' before it.
2. q is a 32-bit constant pointer to an integer.



3. When `__ptr32` is used, the program expects that the address of the pointer variable is less than or equal to 31 bits. You might need to ensure this by calling a special runtime function, such as the Language Environment runtime function `__malloc31`. You can call `__malloc31` whenever you use your own assembler routine to get storage, and want to keep the addresses in structures and unions to a length of four bytes.
4. If a pointer declaration does not have the size qualifier, it defaults to the size of the data model.

## Potential pointer corruption

When porting a program from ILP32 to LP64, be aware of the following potential problems:

- An invalid address might be the result of either of the following actions:
  - Assigning an integer (4 bytes) or a 4-byte hexadecimal constant to a pointer type variable (8 bytes)
  - Casting a pointer to an integer type

**Note:** An invalid address causes errors when the pointer is dereferenced.

- If you compare an integer to a pointer, you might get unexpected results.
- Data truncation might result if you convert pointers to signed or unsigned integers with the expectation that the pointer value will be preserved.
- If return values of functions that return pointers are assigned to an integer type, those return values will be truncated.
- If code assumes that pointers and integers are the same size (in an arithmetic context), there will be problems. Pointer arithmetic is often a source of problems when migrating code. The ISO C and C++ standards dictate that incrementing a pointer adds the size of the data type to which it points to the pointer value. For example, if the variable `p` is a pointer to `long`, the operation `(p+1)` increments the value of `p` by 4 bytes (in 32-bit mode) or by 8 bytes (in 64-bit mode). Therefore, casts between `long*` and `int*` are problematic because of the size differences between pointer objects (32 bits versus 64 bits).

## Potentially incorrect pointer-to-int and int-to-pointer conversions

Before porting code, It is important to test the ILP32 code to determine if any code paths would have incorrect results under LP64. For example:

- When a pointer is explicitly converted to an integer, truncation of the high-order word occurs.
- When an integer is explicitly converted to a pointer, the pointer might not be correct, which could result in invalid memory access when the pointer is dereferenced.

*Table 61. Example of source code that explicitly converts an integer to a pointer*

<b>Source:</b>	<pre> 1  #include &lt;stdio.h&gt; 2  #include &lt;stdlib.h&gt; 3  int main() 4  { 5      int i, *p, *q; 6      p = (int*)malloc(sizeof(int)); 7      i = (int)p; 8      q = (int*)i; 9      p[0] = 55; 10     printf("p = %p q = %p\n", p, q); 11     printf("p[0] = %d q[0] = %d\n", p[0], q[0]); 12 } </pre>
----------------	--

Table 61. Example of source code that explicitly converts an integer to a pointer (continued)

<b>Compiler options:</b>	c89 -Wc,"flag(i),warn64" -c warn7.c
<b>Output:</b>	<p>INFORMATIONAL CCN3744 ./warn7.c:7 64-bit portability: possible truncation of pointer through conversion of pointer type into int type.</p> <p>INFORMATIONAL CCN3745 ./warn7.c:8 64-bit portability: possible incorrect pointer through conversion of int type into pointer.</p>

**Notes:**

1. Under ILP32, the pointers p and q are pointing to the same memory location.
2. Under LP64, the pointer q is likely pointing to an invalid address, which could result in a segmentation fault when q is dereferenced.
3. Warning messages are generated for invalid conversions, as shown in Table 61 on page 342.

**Potential truncation problem with a pointer cast conversion**

As Table 62 shows, truncation problems can occur when converting between 64-bit and 32-bit data objects. Because int and long are both 32 bits under ILP32, a mixed assignment or conversion between these data types did not represent any problem. However, under LP64, a mixed assignment or conversion does present problems because long is larger in size than int. Without an explicit cast, the compiler is unable to determine whether the narrowing of assignment is intended. If the value l is always within the range representable by an int, or if the truncation is intended by design, use an explicit cast to silent the WARN64 message that you will receive for this code.

Table 62. Example of truncation problem with a pointer cast conversion

<b>Source:</b>	<pre>void foo(long l) {     int i = l; }</pre>
<b>Compiler options:</b>	cc -Wc,"flag(i),warn64" -c warn1.c
<b>Output:</b>	WARNING CCN3742 ./warn1.c:3 64-bit portability: possible loss of digits through conversion of long int type into int type.

**Potential loss of data in constant expressions**

A loss of data can occur in some constant expressions because of lack of precision. These types of problems are very hard to find and might be unnoticed. It is possible to write data-neutral code that can be compiled under both ILP32 and LP64.

When coding constant expressions, you must be very explicit about specifying types and use the constant suffixes {u,U,l,L,ll,LL} to specify types, as shown in Table 63 on page 344. You could also use casts to specify the type of a constant expression.

It is especially important to code constant expressions carefully when you are porting programs to a 64-bit environment because integer constants might have different types when compiled in 64-bit mode. The ISO C and C++ standards state that the type of an integer constant, depending on its format and suffix, is the first (that is, smallest) type in the corresponding list that will hold the value. The

number of leading zeros does not influence the type selection. Table 63 describes the type of an integer constant according to the ISO standards.

Table 63. Type of an integer constant

Suffix	Decimal constant	Octal or hexadecimal constant
unsuffixed	int long unsigned long	int unsigned int long unsigned long
u or U	unsigned int unsigned long	unsigned int unsigned long
l or L	long unsigned long	long unsigned long
Both u or U and l or L	unsigned long	unsigned long
ll or LL	long long	long long unsigned long long
Both u or U and ll or LL	unsigned long long	unsigned long long

**Note:** Under LP64, a change in the type of a constant in an expression might cause unexpected results because long is equal to long long. For example, an unsuffixed hexadecimal constant that can be represented only by an unsigned long in 32-bit mode can fit within a long in 64-bit mode.

## Data alignment problems when structures are shared

Modern processor designs usually require data in memory to be aligned to their natural boundaries, in order to gain the best possible performance. In most cases, the compiler ensures proper alignment by inserting padding bytes immediately in front of the misaligned data. Although the padding bytes do not affect the integrity of the data, they might result in an unexpected layout, which affects the size of structures and unions.

Because both pointer size and long size are doubled in 64-bit mode, structures and unions containing them as members are larger than they are in 32-bit mode.

**Attention:** The example in Table 64 is for illustrative purposes only. Sharing pointers between 32-bit and 64-bit processes is *not recommended* and will likely yield incorrect results.

Table 64. An attempt to share pointers between 32-bit and 64-bit processes

<b>Attention:</b> <b>Source:</b>	<pre>#include &lt;stdio.h&gt; #include &lt;stddef.h&gt; int main() {     struct T {         char c;         int *p;         short s;     } t;     printf("sizeof(t) = %d\n", sizeof(t));     printf("offsetof(t, c) = %d sizeof(c) = %d\n",         offsetof(struct T, c), sizeof(t.c));     printf("offsetof(t, p) = %d sizeof(p) = %d\n",         offsetof(struct T, p), sizeof(t.p));     printf("offsetof(t, s) = %d sizeof(s) = %d\n",         offsetof(struct T, s), sizeof(t.s)); }</pre>
-------------------------------------	--

Table 64. An attempt to share pointers between 32-bit and 64-bit processes (continued)

<b>ILP32 output:</b>	sizeof(t) = 12 offsetof(t, c) = 0 sizeof(c) = 1 offsetof(t, p) = 4 sizeof(p) = 4 offsetof(t, s) = 8 sizeof(s) = 2
<b>LP64 output:</b>	sizeof(t) = 24 offsetof(t, c) = 0 sizeof(c) = 1 offsetof(t, p) = 8 sizeof(p) = 8 offsetof(t, s) = 16 sizeof(s) = 2

**Notes:**

1. When the source is compiled and executed under ILP32, the result indicates that paddings have been inserted before the member p, and after the member s. Three padding bytes have been inserted before the member p to ensure that p is aligned to its natural 4-byte boundary. The alignment of the structure itself is the alignment of its strictest member. In this example, it is a 4-byte alignment because the member p has the strictest alignment. Two padding bytes are inserted at the end of the structure to make the total size of the structure a multiple of 4 bytes. This is required so that if you declare an array of this structure, each element of the array will be aligned properly.
2. When the source is compiled and executed under LP64, the size of the structure doubles because additional padding is required to force the member p to fall on a natural alignment boundary of 8-bytes.

Figure 97 on page 346 illustrates how the compiler treats the source code shown in Table 64 on page 344 under ILP32 and LP64. Because the pointer is a different size in each environment, they are aligned on different boundaries. This means that if the code is compiled under both ILP32 and LP64, there are likely to be alignment problems. Figure 98 on page 350 illustrates the solution, which is to define padding members of type character that prevent the possibility of data misalignment. Table 67 on page 349 shows the necessary modifications to the code in Table 64 on page 344.

If the structure in Table 64 on page 344 is shared or exchanged among 32-bit and 64-bit processes, the data fields (and padding) of one environment will not match the expectations of the other, as shown in Figure 97 on page 346.

ILP32

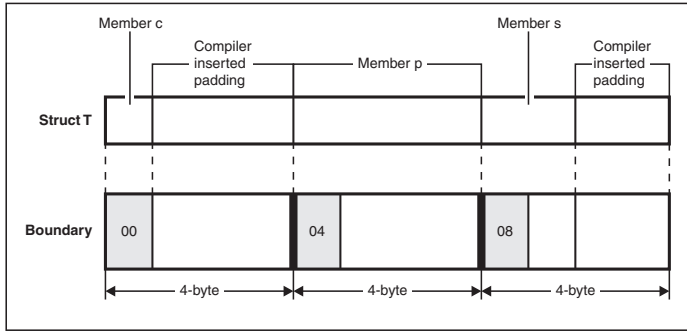

LP64

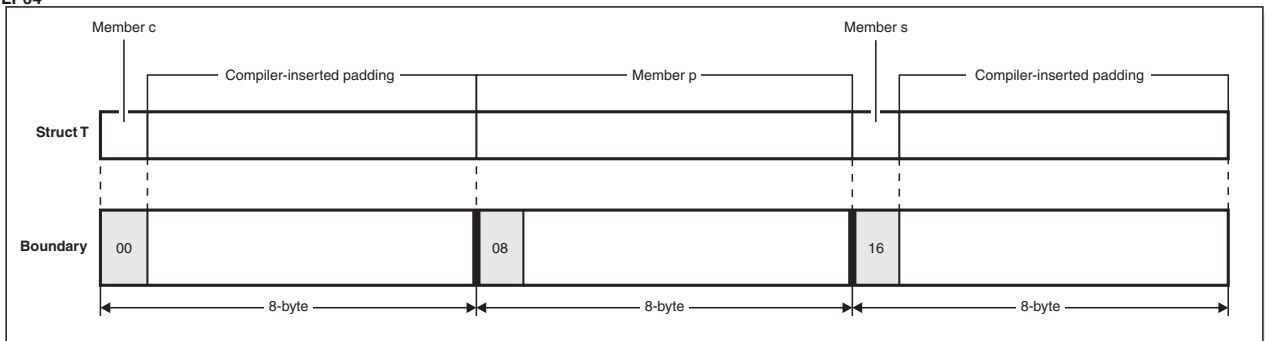

Figure 97. Example of potential alignment problems when a struct is shared or exchanged among 32-bit and 64-bit processes.

## Portability issues with unsuffixed numbers

When porting code, be aware that:

- Unsuffixed constants are more likely to become 8 bytes long if they are in hexadecimal.
- All constants that can impact any constant assignment must be explicitly suffixed.

### Example of unexpected behavior resulting from use of unsuffixed numbers

This causes some operations, such as one that compares `sizeof(4294967295)` to another value, to return 8. If you add the suffix `U` to the number (`4294967295U`), the compiler can parse it as unsigned int.

Table 65. Example of unexpected behavior resulting from use of unsuffixed numbers

Source:	<pre> #include &lt;stdio.h&gt; #include &lt;limits.h&gt; void main(void) {     long l = LONG_MAX;     printf("size(2147483647) = %d\n",sizeof(2147483647));     printf("size(2147483648) = %d\n",sizeof(2147483648));     printf("size(4294967295U) = %d\n",sizeof(4294967295U));     printf("size(-1) = %d\n",sizeof(-1));     printf("size(-1L) = %d\n",sizeof(-1L));     printf("LONG_MAX = %d\n",1); } </pre>
---------	---

Table 65. Example of unexpected behavior resulting from use of unsuffixed numbers (continued)

<b>ILP32 output:</b>	<pre>size(2147483647) = 4 size(2147483648) = 4 size(4294967295U) = 4 size(-1) = 4 size(-1L) = 4 LONG_MAX = 2147483647</pre>
<b>LP64 output:</b>	<pre>size(2147483647) = 4 size(2147483648) = 8 size(4294967295U) = 4 size(-1) = 4 size(-1L) = 8 LONG_MAX = -1 <b>1</b></pre>

### Example of how a suffix causes the compiler to parse the number differently under ILP32 than under LP64

**Example:** A number like 4294967295 (UINT\_MAX), when parsed by the compiler, will be

- An unsigned long under ILP32
- A signed long under LP64

## Using a LONG\_MAX macro in a printf subroutine

The printf subroutine format string for a 64-bit integer is different than the string used for a 32-bit integer. Programs that do these conversions must use the proper format specifier.

Under LP64, you must also consider the maximum number of digits of the long and unsigned long types. The ULONG\_MAX is twenty digits long, and the LONG\_MAX is nineteen digits.

In Table 66, the code assumes that the long type is the same size as the int type (as it would be under ILP32). That is, %d is used instead of %ld.

Table 66. Example of using LONG\_MAX macros in a printf subroutine

<b>Source:</b>	<pre>#include &lt;stdio.h&gt; int main(void) {     printf("LONG_MAX( d) = %d\n", LONG_MAX);     printf("LONG_MAX( x) = %x\n", LONG_MAX);     printf("LONG_MAX(1u) = %lu\n", LONG_MAX);     printf("LONG_MAX(1x) = %lx\n", LONG_MAX); }</pre>
<b>LONG_MAX value:</b>	9,223,372,036,854,775,807
<b>Output:</b>	<pre>LONG_MAX( d) = -1 LONG_MAX( x) = ffffffff LONG_MAX(1u) = 9223372036854775807 LONG_MAX(1x) = 7fffffffffffffff</pre>

#### Notes:

1. Under LP64:
  - %ld must be used
  - %x will give incorrect results and must be replaced by %p or %lx
2. A similar example would produce the same results for an unsigned long with a ULONG\_MAX value of 18,446,744,073,709,551,615.

---

## Programming for portability between ILP32 and LP64

When you want to program for portability between the ILP32 and LP64 environments, you can use the following strategies:

- Header files to provide type definitions
- Suffixes and explicit types to prevent unexpected behavior
- Defining pad members to avoid data alignment problems
- Prototypes to avoid debugging problems
- Conditional compiler directive for preprocessor macro selection
- Converters
- Locales

### Using header files to provide type definitions

The header file `inttypes.h` provides type definitions for integer types that are guaranteed to have a specific size (for example, `int32_t` and `int64_t`, and their unsigned variations). Consider using those type definitions if your program code relies on types with specific sizes.

There are many ways to use headers to handle code that is portable between ILP32 and LP64. You can minimize the amount of conditional compilation code and avoid having totally different sections of code for a ILP32 and LP64 structure definitions if you adopt a coding convention that suits your environment.

If you provide a library to your application users and ship header files that define the application programming interface of the library, consider shipping a single set of headers that can support both 32-bit and 64-bit versions of your library. You can use the type definitions in `inttypes.h`. For example, if you are currently shipping 32-bit versions of your header files, you could:

- Replace all fields of type `long` with type `int32_t` (or another 32-bit type)
- Similarly replace all fields for the unsigned variation
- If you cannot let a 64-bit application use a 64-bit pointer for a field, use the `__ptr32` qualifier.

### Using suffixes and explicit types to prevent unexpected behavior

The C language limit (in `limits.h`) is different under LP64 than it is under ILP32. As the following example shows, you can prevent unexpected behavior by an application by using suffixes and explicit types with all numbers.

```
#ifdef _LP64
#define LONG_MAX (9223372036854775807L)
#define LONG_MIN (-LONG_MAX - 1)
#define ULONG_MAX (18446744073709551615U)
#else
#define LONG_MAX INT_MAX
#define LONG_MIN INT_MIN
#define ULONG_MAX (UINT_MAX)
#endif /* _LP64 */
```

**Note:** The output for `LONG_MAX` is not really -1. The reason for the -1 is that:

- The `printf` subroutine handles it as an integer
- `(LONG_MAX == (int)LONG_MAX)` returns a negative value

## Defining pad members to avoid data alignment problems

If you want to allow the structure to be shared, you might be able to reorder the fields in the data structure to get the alignments in both 32-bit and 64-bit environments to match (as shown in Table 54 on page 333), depending on the data types used in the structure and the way in which the structure as a whole is used (for example, whether the structure is used as a member of another structure or as an array).

If you are unable to reorder the members of a structure, or if reordering alone cannot provide correct alignment, you can define paddings that force the members of the structure to fall on their natural boundaries regardless of whether it is compiled under ILP32 or LP64. A conditional compilation section is required whenever a structure uses data types that have different sizes in 32-bit and 64-bit environments.

The example in Table 67 shows how the source code in Table 64 on page 344 can be modified to avoid the data alignment problem.

Table 67. Example of source code that successfully shares pointers between ILP32 and LP64 programs

<b>Source:</b>	<pre>struct T {     char c;     short s;     #if !defined(_LP64)         char pad1[4];     #endif     int *p;     #if !defined(_LP64)         char pad2[4];     #endif } t</pre>
<b>ILP32/ LP64 size and member layout:</b>	<pre>sizeof(t) = 16 offsetof(t, c) = 0 sizeof(c) = 1 offsetof(t, s) = 2 sizeof(s) = 2 offsetof(t, p) = 8 sizeof(p) = 4</pre>

Figure 98 on page 350 shows the member layout of the structure with user-defined padding. Because the pointer is a different size in each environment, it is aligned on different a boundary in each environment. This means that if the code is compiled under both ILP32 and LP64, there are likely to be alignment problems. This figure illustrates the solution, which is to define pad members of type character that prevent the possibility of data misalignment.

**Note:** When inserting paddings into structures, use an array of characters. The natural alignment of a character is 1-byte, which means that it can reside anywhere in memory.



### ILP32

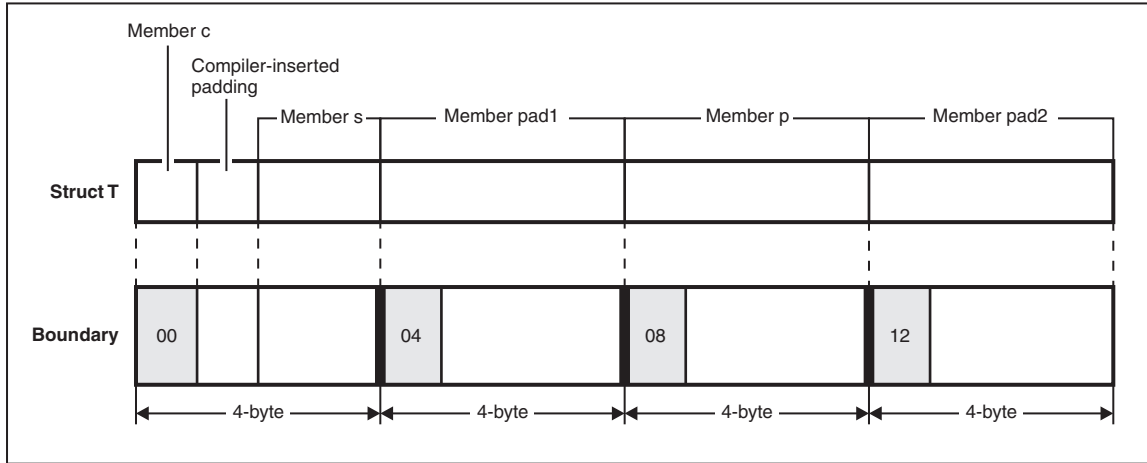

### LP64

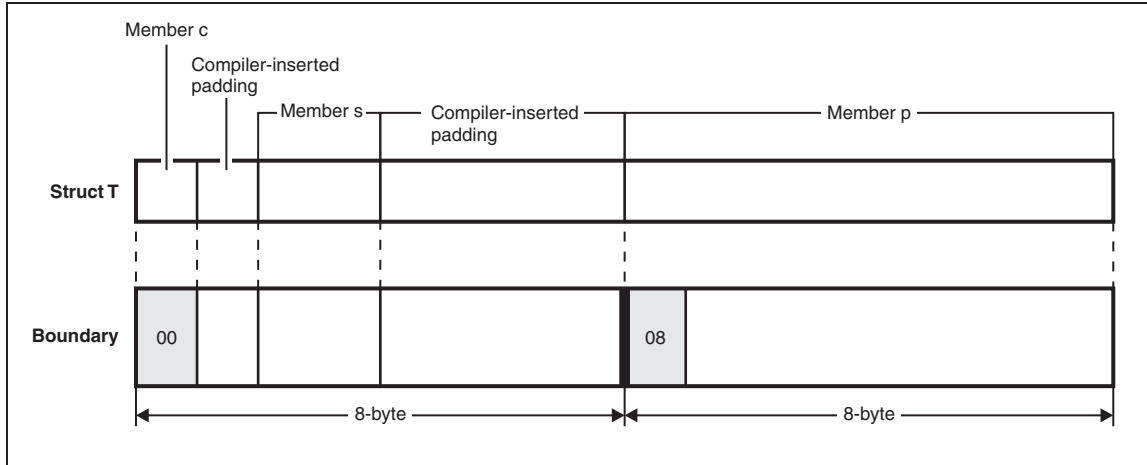

Figure 98. Example of user-defined data padding for a structure that is shared or exchanged among 32-bit and 64-bit processes.

## Using prototypes to avoid debugging problems

You can avoid complex debugging problems by ensuring that all functions are prototyped.

The C language provides a default prototype. If a function is not prototyped, it defaults to a function which returns an integer and has no information about the parameters.

The C++ language does not provide a default and always requires a prototype. However, C++ has an implicit integer return type extension for legacy code.

A common problem is that the default return type of `int` might not remain the same size as an associated pointer. For example, the function `malloc()` can cause truncation when an unprototyped function returns a pointer. This is because an unprototyped function is assumed to return an `int` (4 bytes).

## Using a conditional compiler directive for preprocessor macro selection

When the compiler is invoked with the LP64 option, the preprocessor macro `_LP64` is defined. When the compiler is invoked with the ILP32 option, the macro `_ILP32` is defined.

You can use a conditional compiler directive such as `#if defined _LP64` or `#ifdef _LP64` to select lines of code (such as `printf` statements) that are appropriate for the data model that is invoked.

## Using converters under ILP32 or LP64

Both table-driven converters (such as `EDCGNXL` proc) and indirect UCS-2 converters (such as the `uconvdef` UNIX System Services utility) function the same in both 32-bit and 64-bit environments. The naming convention requires that dataset member names must begin with `CEQ`.

### Notes:

1. `GENXLT` converters are shipped only in data sets.
2. The converter objects that are shipped with `z/OS V2R2` allow existing applications to work at a basic level only. You might need to build customized objects.

## Using locales under ILP32 or LP64

The locale objects that are shipped with `z/OS V2R2` allow existing applications to work at a basic level only. You might need to build customized objects.

### Customized 64-bit locales

If you need to create 64-bit locales, you must use the UNIX System Services `localdef` utility with the new `-6` compiler option.

- If the locales are dataset members, they must have the `CEQ` prefix.
- If the locales are `zFS`-resident or UNIX file system-resident, they must have the `.lp64` suffix.

**Note:** There is no batch or TSO `LOCALDEF` support for 64-bit locales.

### Old SAA locales

Old SAA locales (such as `EDC$FRAN`) are not supported by the LP64 model.



---

## Chapter 24. Using threads in z/OS UNIX applications

A thread is a single flow of control within a process. The following section describes some of the advantages of using multiple threads within a single process, and functions that can be used to maintain this environment.

---

### Models and requirements

Threads are efficient in applications that allow them to take advantage of any underlying parallelism available in the host environment. This underlying parallelism in the host can be exploited either by forking a process and creating a new address space, or by using multiple threads within a single process. There are advantages and disadvantages to both techniques, but it primarily comes down to a compromise between the efficiency of using multiple threads versus the security of working in separate address spaces. The POSIX(ON) runtime option must be specified to use threads.

### Functions

Table 68 lists the functions provided to implement a multi-threaded application.

*Table 68. Functions used in creating multi-threaded applications*

Function	Purpose
pthread_create()	Create a thread
pthread_join()	Wait for thread termination
pthread_exit()	Terminate a thread normally
pthread_detach()	Detach a thread
pthread_self()	Get your thread ID
pthread_equal()	Compare thread IDs
pthread_once()	Run a function once per process
pthread_yield()	Yield the processor

### Creating a thread

To use a thread you must first create a thread attribute object with the `pthread_attr_init()` function. A thread attribute object defines the modifiable characteristics that a thread may have. Refer to the description of `pthread_attr_init()` in *z/OS XL C/C++ Runtime Library Reference* for a list of the attributes and their default values. When the thread attribute object has been created, you may use the functions listed in Table 69 to change the default attributes.

*Table 69. Functions to change default attributes*

Function	Purpose
pthread_attr_init()	Initialize a thread attribute object
pthread_attr_destroy()	Delete a thread attribute object
pthread_attr_getguardsize()	Gets the threadstack guardsize from the thread attribute object

Table 69. Functions to change default attributes (continued)

Function	Purpose
<code>pthread_attr_setguardsize()</code>	Sets the threadstack guardsize in the thread attribute object
<code>pthread_attr_getschedparam()</code>	Gets the schedparam from the thread attribute object
<code>pthread_attr_setschedparam()</code>	Sets the schedparam in the thread attribute object
<code>pthread_attr_getstack()</code>	Gets the stacksize and base storage address of application-managed stack
<code>pthread_attr_setstack()</code>	Sets the stacksize and base storage address of application-managed stack
<code>pthread_attr_getstacksize()</code>	Gets the stacksize for thread attribute object
<code>pthread_attr_setstacksize()</code>	Sets the stacksize for thread attribute object
<code>pthread_attr_getdetachstate()</code>	Returns current value of detachstate for thread attribute object
<code>pthread_attr_setdetachstate()</code>	Alters the current detachstate of thread attribute object
<code>pthread_attr_getweight_np()</code>	Obtains the current weight of thread setting
<code>pthread_attr_setweight_np()</code>	Alters the current weight of thread setting
<code>pthread_attr_getsynctype_np()</code>	Returns the current synctype setting of thread attribute object
<code>pthread_attr_setsynctype_np()</code>	Alters the synctype setting of thread attribute object

The attribute object is only used when the thread is created. You can reuse it to create other threads with the same attributes, or you can modify it to create threads with other attributes. You can delete the attribute object with the `pthread_attr_destroy()` function.

After you create the thread attribute object, you can then create the thread with the `pthread_create()` function.

When a daughter thread is created, the function specified on the `pthread_create()` as the start routine begins to execute concurrently with the thread that issued the `pthread_create()`. It may use the `pthread_self()` function to determine its thread ID. The daughter thread will continue to execute until a `pthread_exit()` is issued, or the start routine ends. The function that issued the `pthread_create()` resumes as soon as the daughter thread is created. The daughter thread ID is returned on a successful `pthread_create()`. This thread ID, for example, can be used to send a signal to the daughter thread using `pthread_kill()` or it can be used in `pthread_join()` to cause the initiating thread to wait for the daughter thread to end.

Table 70 lists functions that can be used to control the behavior of the individual threads in a multi-threaded application. Refer to *z/OS XL C/C++ Runtime Library Reference* for more information on these functions.

Table 70. Functions used to control individual threads in a multi-threaded environment

Function	Purpose
<code>pthread_equal()</code>	Compares two thread IDs
<code>pthread_yield()</code>	Allows threads to give up control

## Synchronization primitives

This section covers the control of multiple threads that may share resources. In order to maintain the integrity of these resources, a method must exist for the threads to communicate their use of, or need to use, a resource. The threads can be within a common process or in different processes.

### Models

Mutexes, condition variables, and read-write locks are used to communicate between threads. These constructs may be used to synchronize the threads themselves, or they can also be used to serialize access to common data objects shared by the threads.

- The *mutex*, which is the simple type of lock, is exclusive. If a thread has a mutex locked, the next thread that tries to acquire the same mutex is put in a wait state. This is beneficial when you want to serialize access to a resource. This might cause contention however if several threads are waiting for a thread to unlock a mutex. Therefore, this form of locking is used more for short durations. If the mutex is a shared mutex, it must be obtained in shared memory accessible among the cooperating processes.

A thread in mutex wait will not be interrupted by a signal.

- A *condition variable* provides a mechanism by which a thread can suspend execution when it finds some condition untrue, and wait until another thread makes the condition true. For example, threads could use a condition variable to insure that only one thread at a time had write access to a data set.

Threads in condition wait can be interrupted by signals.

- A *read-write lock* can allow many threads to have simultaneous read-only access to data while allowing only one thread at a time to have write access. The read-write lock must be allocated in memory that is writable. If the read-write lock is a shared read-write lock, it must be obtained in shared memory accessible among the cooperating processes.

### Functions

Table 71 lists functions that allow for synchronization between threads.

Table 71. Functions that allow for synchronization between threads

Function	Purpose
<code>pthread_mutex_init()</code>	Initialize a Mutex
<code>pthread_mutex_destroy()</code>	Destroy a Mutex
<code>pthread_mutexattr_init()</code>	Initialize Default Attribute Object for a Mutex
<code>pthread_mutexattr_destroy()</code>	Destroy Attribute Object for a Mutex
<code>pthread_mutexattr_getkind_np()</code>	Get Kind Attribute for a Mutex
<code>pthread_mutexattr_setkind_np()</code>	Set Kind Attribute for a Mutex
<code>pthread_mutexattr_gettype()</code>	Get Type Attribute for a Mutex
<code>pthread_mutexattr_settype()</code>	Set Type Attribute for a Mutex
<code>pthread_mutexattr_getpshared()</code>	Get Process-shared Attribute for a Mutex
<code>pthread_mutexattr_setpshared()</code>	Set Process-shared Attribute for a Mutex
<code>pthread_mutex_lock()</code>	Acquire a Mutex Lock
<code>pthread_mutex_unlock()</code>	Release a Mutex Lock
<code>pthread_mutex_trylock()</code>	Allows lock to be tested
<code>pthread_cond_init()</code>	Initialize a Condition Variable

Table 71. Functions that allow for synchronization between threads (continued)

Function	Purpose
<code>pthread_cond_destroy()</code>	Destroy a Condition Variable
<code>pthread_condattr_init()</code>	Initialize Default Attribute Object for a Condition Variable
<code>pthread_condattr_destroy()</code>	Destroy Attributes Object for a Condition Variable
<code>pthread_condattr_getkind_np()</code>	Get Attribute for Condition Variable object
<code>pthread_condattr_setkind_np()</code>	Set Attribute for Condition Variable object
<code>pthread_condattr_getpshared()</code>	Get the Process-shared Condition Variable Attribute
<code>pthread_condattr_setpshared()</code>	Set the Process-shared Condition Variable Attribute
<code>pthread_cond_wait()</code>	Wait for a Condition Variable
<code>pthread_cond_timedwait()</code>	Timed wait for a Condition Variable
<code>pthread_cond_signal()</code>	Signal a Condition Variable
<code>pthread_cond_broadcast()</code>	Broadcast a Condition Variable
<code>pthread_rwlock_init()</code>	Initialize a Read-Write Lock
<code>pthread_rwlock_destroy()</code>	Destroy a Read-Write Lock
<code>pthread_rwlock_rdlock()</code>	Wait for a Read Lock
<code>pthread_rwlock_tryrdlock()</code>	Allows Read Lock to be Tested
<code>pthread_rwlock_trywrlock()</code>	Allows Read-Write Lock to be Tested
<code>pthread_rwlock_unlock()</code>	Release a Read-Write Lock
<code>pthread_rwlock_wrlock()</code>	Wait for a Read-Write Lock
<code>pthread_rwlockattr_init()</code>	Initialize Default Attribute Object for a Read-Write Lock
<code>pthread_rwlockattr_destroy()</code>	Destroy Attribute Object for a Read-Write Lock
<code>pthread_rwlockattr_getpshared()</code>	Get Process-shared Attribute for a Read-Write Lock
<code>pthread_rwlockattr_setpshared()</code>	Set Process-shared Attribute for a Read-Write Lock

## Creating a mutex

To use the mutex lock you must first create a mutex attribute object with the `pthread_mutexattr_init()` function. A mutex attribute object defines the modifiable characteristics that a mutex may have. Refer to the description of `pthread_mutexattr_init()` in *z/OS XL C/C++ Runtime Library Reference* for a list of these attributes and their defaults.

After the mutex attribute object has been created, you can use the following functions to change the default attributes.

- `pthread_mutexattr_getkind_np()`
- `pthread_mutexattr_setkind_np()`
- `pthread_mutexattr_gettype()`
- `pthread_mutexattr_settype()`
- `pthread_mutexattr_getpshared()`
- `pthread_mutexattr_setpshared()`

The mutex attribute object is used only when creating the mutex. It can be used to create other mutexes with the same attributes or modified to create mutexes with different attributes. You can delete a mutex attribute object with the `pthread_mutexattr_destroy()` function.

After the mutex attribute object has been created, the mutex can be created with the `pthread_mutex_init()` function.

While using mutexes as the locking device, the following functions can be used:

- `pthread_mutex_lock()`
- `pthread_mutex_unlock()`
- `pthread_mutex_trylock()`

To remove the mutex, use the `pthread_mutex_destroy()` function.

**Note:** Before freeing up the storage containing the `pthread_mutexattr_t` object, be sure to destroy it by calling `pthread_mutexattr_destroy()`. If the `pthread_mutexattr_t` object is not destroyed before the storage is reused, the results are undefined.

### Creating a condition variable

Before creating a condition variable, you need to create a mutex (as shown above), then you must use the `pthread_condattr_init()` function to create a condition variable attribute object. This attribute object, like the mutex attribute object, defines the modifiable characteristics that a condition variable may have. Refer to the description of `pthread_condattr_init()` in *z/OS XL C/C++ Runtime Library Reference* for a list of these attributes and their defaults.

After the condition variable attribute object has been created, you may use the following functions to change the default attributes:

- `pthread_condattr_getkind_np()`
- `pthread_condattr_setkind_np()`
- `pthread_condattr_getpshared()`
- `pthread_condattr_setpshared()`

The condition variable attribute object is used only when creating the condition variable. It can be used to create other condition variables with the same attributes or modified to create condition variables with different attributes. You can delete a condition variable attribute object with the `pthread_condattr_destroy()` function.

After a condition variable attribute object has been created, the condition variable itself can be created with the `pthread_cond_init()` function.

Condition variables can then be used as a synchronization primitive using the following functions:

- `pthread_cond_wait()`
- `pthread_cond_timedwait()`
- `pthread_cond_signal()`
- `pthread_cond_broadcast()`

The condition variable can be removed with the `pthread_cond_destroy()` function.



## Creating a read-write lock

To use a read-write lock you must first create a read-write attribute object with the `pthread_rwlockattr_init()` function. A read-write attribute object defines the modifiable characteristics that a read-write lock may have. Refer to the description of `pthread_rwlockattr_init()` in *z/OS XL C/C++ Runtime Library Reference* for a list of these attributes and their defaults.

After the read-write lock attribute object has been created, you can use the following functions to change the default attributes.

- `pthread_rwlockattr_getpshared()`
- `pthread_rwlockattr_setpshared()`

The read-write lock attribute object is used only when creating the read-write lock. It can be used to create other read-write locks with the same attributes or modified to create read-write locks with different attributes. You can delete a read-write attribute object with the `pthread_rwlockattr_destroy()` function.

After the read-write attribute has been created, the read-write lock can be created with the `pthread_rwlock_init()` function.

While using read-write locks as the locking device, the following functions can be used:

- `pthread_rwlock_rdlock()`
- `pthread_rwlock_tryrdlock()`
- `pthread_rwlock_wrlock()`
- `pthread_rwlock_trywrlock()`
- `pthread_rwlock_unlock()`

To remove the read-write lock, use the `pthread_rwlock_destroy()` function.

## Thread-specific data

While all threads can access the same memory, it is sometimes desirable to have data that is (logically) local to a specific thread. The *key/value* mechanism provides for global (process-wide) keys with value bindings that are unique to a thread.

You can also use the `pthread_tag_np()` function to set and query 65 bytes of thread tag data associated with the caller's thread.

### Model

The *key/value mechanism* associates a data key with each data item. When the association is made, the key identifies the data item with a particular thread. This data key is a transparent data object of type `pthread_key_t`. The contents of this key are not exposed to the user.

The user gets a key by issuing the `pthread_key_create()` function. One of the arguments on the `pthread_key_create()` function is a pointer to a local variable of type `pthread_key_t`. This variable is then used with the `pthread_setspecific()` function to establish a unique key value.

`pthread_key_create()` creates a unique identifier (a key) that is visible to all of the threads in a process. This data key is returned to the caller of `pthread_key_create()`. Threads can associate a thread unique data item with this key using the `pthread_setspecific()` call. A thread can get its unique data value for a key using the `pthread_getspecific()` call. In addition, a key can have an

optional "destructor" routine associated with it. This routine is executed during thread termination and is passed the value of the key for the thread being terminated. A typical use of a key and destructor is to have storage obtained by a thread using `malloc()` and returned within the destructor at thread termination by using `free()`.

`pthread_key_delete()` deletes a thread-specific data key. Once a key has been deleted, it may not be passed to `pthread_getspecific()` or `pthread_setspecific()`. Any destructor function associated with the key when it was created will no longer be called. The application must perform any cleanup needed for values associated with the key.

## Functions

Table 72 lists functions that are used with thread-specific data.

*Table 72. Functions used with thread-specific data*

<b>Function</b>	<b>Purpose</b>
<code>pthread_key_create()</code>	Create a thread-specific data key
<code>pthread_key_delete()</code>	Delete a thread-specific data key
<code>pthread_getspecific()</code>	Retrieve the value associated with a thread-specific key
<code>pthread_setspecific()</code>	Associate a value with a thread-specific key
<code>pthread_tag_np()</code>	Set and query the contents of the calling thread's tag data

## Creating thread-specific data

Figure 99 on page 360 shows the example program `CCNGTH1`, which uses thread-specific data to insure that storage acquired by a specific thread is freed when the thread ends.

---

```

#define _OPEN_THREADS
#include <stdio.h>
#include <pthread.h>
pthread_key_t mykey;          /* A place to get the key */
void mydestruct(void *value); /* My destructor routine */
main()
{
    char * thddataptr;
    /* Create a key, getting back the key from pthread_key_create(),
       and associate a function to be executed at thread termination
       for this key */

    (void)pthread_key_create(&mykey,&mydestruct);

    /* Obtain some storage which this thread will manage (remember,
       the main is also a thread), which we want freed by our
       destructor upon thread termination. Associate the storage
       pointer with the key using pthread_setspecific.
    */
    thddataptr = (char *) malloc(100);
    (void)pthread_setspecific(mykey,thddataptr);

    /* the body of the function

    /* now, the thread exits, causing the thread termination
       key data destructor to be executed.
    */
    pthread_exit((void *)0);
}
/* The key data destructor function
*/
void mydestruct(void * value) {
    /* value is the value in the key/value binding that is unique
       to the thread being terminated. Thus, in the example,
       it represents the pointer to the storage needing freed.
    */
    free(value);
}

```

---

Figure 99. Referring to thread-specific data

## Signals

Each thread has an associated signal mask. The signal mask contains a flag for each signal defined by the system. The flag determines which signals are to be blocked from being delivered to a particular thread.

Unlike the signal mask, there is one signal action per signal for all of the threads in the process. Some signal functions work on the process level, having an impact on multiple threads, while others work on the thread level, and only affect one particular thread. For example, the function `kill()` operates at the process level, whereas the functions `pthread_kill()` and `sigwait()` operate at the thread level.

The following are some other signal functions that operate on the process level and can influence multiple threads:

- `alarm()`
- `bsd_signal()`
- `kill()`
- `killpg()`
- `raise()`

- `sigaction()`
- `siginterrupt()`
- `signal()`
- `sigset()`

## Generating a signal

A signal can be generated explicitly with the `raise()`, `kill()`, `killpg()`, or `pthread_kill()` functions or implicitly with functions such as `alarm()` or by the system when certain events occur. In all cases, the signal will be directed to a specific thread running in a process.

The two primary functions for controlling signals are `sigaction()` and `sigprocmask()`. `sigaction()` also includes `bsd_signal()`, `signal()`, and `sigset()`.

### **sigaction()**

`sigaction()` specifies the action when a signal is processed by the system. This function is process-scoped instead of thread-specific. When a signal is generated for a process, the state of each thread within that process determines which thread is affected. The three types of signal actions are:

#### **catcher**

Specifies the address of a function that will get control when the signal is delivered

#### **SIG\_DFL**

Specifies that the system should perform default processing when this signal type is generated

#### **SIG\_IGN**

Specifies that the system should ignore all signals of this type.

**Attention:** If a signal whose default action is to terminate is delivered to a thread running in a process where there are multiple threads running, and no signal catcher is designated for the signal, the entire process is terminated. You can avoid this by blocking each of the terminating signals, or by establishing a signal catcher for each of them.

In a multi-threaded application, when a signal is generated by a function or action that is not thread specific, and the process has some threads set up for signals and some threads that are not set up for signals, then the kernel's signal processing determines which thread has the most interest in the signal.

The following is a list of signal interest rules in their order of priority:

1. When threads are found in a `sigwait()` for this signal type, the signal is delivered to the first thread found in a `sigwait()`.
2. When all threads are blocking this signal type, the signal is left pending in the kernel at the process level. The `sigpending` function moves blocked pending signals at the process level to the thread level.
3. When all of the following are true:
  - One or more threads are set up for signals
  - All threads set up for signals have the signal blocked
  - A thread not set up for signals has not blocked the signal

The signal is left pending in the kernel on the first thread set up for signals. The signal remains pending on that thread until the thread unblocks the signal.

4. When the signal action is to catch, the signal is delivered to one of the threads that has the signal unblocked.

### **sigprocmask()**

`sigprocmask()` specifies a way to control which set of signals interrupt a specific thread. Because `sigprocmask()` is thread-scoped, it blocks the signal for only the thread that issues the function.

## **Thread cancellation**

When multiple threads are running in a process, thread cancellation permits one thread to cancel another thread in that process. This is done with the `pthread_cancel()` function, which causes the system to generate a cancel interrupt and direct it to the thread specified on the `pthread_cancel()`. Each thread can control how the system generates this cancel interrupt by altering the interrupt state and type.

A thread may have the following interrupt states, in descending order of control:

### **disabled**

For short code sequences, the entire code sequence can be disabled to prevent cancel interrupts. The `pthread_setintr()` and `pthread_setcancelstate()` functions enable or disable cancel interrupts in this manner.

### **controlled**

For larger code sequences where you want some control over the interrupts but cannot be entirely disabled, set the interrupt type to controlled/deferred and the interrupt state to enabled. The `pthread_setintrtype()` and `pthread_setcanceltype()` functions allow for this type of managed interrupt delivery by introducing the concept of cancellation points.

Cancellation points consist of calls to a limited set of library functions, documented below.

The user program can implicitly or explicitly solicit interrupts by invoking one of the library functions in the set of cancellation points, thus allowing the user to control the points within their application where a cancel may occur.

### **asynchronous**

For code sequences where you do not need any control over the interrupt, set `pthread_setintr()/pthread_setcancelstate()` to enable and `pthread_setintrtype()/pthread_setcanceltype()` to asynchronous. This will allow cancel interrupts to occur at any point within your program.

For example, if you have a critical code section (a sequence of code that needs to complete), you would turn cancel off or prevent the sequence from being interrupted. If the code is relatively long, consider running using the `control` interrupt and as long as the critical code section doesn't contain any of the functions that are considered cancellation points, it will not be unexpectedly canceled.

For C++, destructors for automatic objects on the stack are run when a thread is cancelled. The stack is unwound and the destructors are run in reverse order.

## Cancellation Points

The library functions listed in Table 73, and any of their callers, will introduce cancellation points into a thread's execution.

Table 73. Cancellation point summary

accept()	aio_suspend()	close()	connect()
creat()	fcntl()	fsync()	getmsg()
getpmsg()	lockf()	msync()	open()
pause()	poll()	pread()	putpmsg()
pwrite()	read()	readv()	recv()
recvfrom()	recvmsg()	select()	send()
sendmsg()	sendto()	sigpause()	sigsuspend()
sigtimedwait()	sigwait()	tcdrain()	usleep()
wait()	waitid()	waitpid()	write()
writew()			

## Functions

Table 74 lists functions that are used to control the cancellability of a thread.

Table 74. Functions used to control cancellability

Function	Purpose
pthread_cancel()	Cancel a thread
pthread_setintr()	Set thread cancellability state
pthread_setintrtype()	Set thread cancellability type
pthread_testintr()	Establish a cancellability point
pthread_setcancelstate()	Set thread cancellability state
pthread_setcanceltype()	Set thread cancellability type
pthread_testcancel()	Establish a cancellability point

## Cancelling a thread

Three possible scenarios may cancel a thread, one for each of the interrupt states of the thread being canceled.

- One thread issues `pthread_cancel()` to another thread whose cancellability state is enabled and controlled. In this case the thread being canceled continues to run until it reaches an appropriate cancellation point. When the thread is eventually cancelled, just prior to termination of the thread, any cleanup handlers which have been pushed and not yet popped will be executed. Then if the thread has any thread-specific data, the destructor functions associated with this data will be executed.
- One thread issues `pthread_cancel()` to another thread whose interruption state is enabled and asynchronous. In this case the thread being canceled is terminated immediately, after any cleanup handlers and thread-specific data destructor functions are executed, as in the first scenario.
- One thread issues `pthread_cancel()` to another thread whose interruption state is disabled. In this case the cancel request is ignored and the thread being canceled continues to run normally.

In the first two interrupt states, the caller of `pthread_cancel()` may get control back before the thread is actually canceled.

## Cleanup for threads

Cleanup handlers are routines written by the user that include any special processing the user finds necessary for termination of a thread. As the user's routine executes, it pushes cleanup handlers on to a stack. As the thread continues to run and the routine progresses, these cleanup handlers can be taken off of the stack by the user's routine.

A list or stack of cleanup handlers is maintained for each thread. When the thread ends, all pushed but not yet popped cleanup routines are popped from the cleanup stack and executed in last-in-first-out (LIFO) order. This occurs when the thread:

- Calls `pthread_exit()`
- Does a return from or reaches the end of the start routine (that gets controls as a result of a `pthread_create()`)
- Is canceled because of a `pthread_cancel()`.

The first thread in a process to call `pthread_create()` becomes the initial `pthread`-creating task (IPT). When exiting back to the operating system from the IPT, the caller may receive an A03 abend if any `pthread_created` tasks are still running. These tasks may still be running even if the IPT has called `pthread_join()` for all the threads that it created. To avoid the A03 abend, the IPT should call `_exit()` when it is ready to return to the operating system. `_exit()` ends the IPT and all of its `pthread_created` subtasks without causing an A03 abend to occur.

### Functions

Table 75 lists functions that are used for thread clean up.

*Table 75. Functions used for cleanup purposes*

Function	Purpose
<code>pthread_cleanup_push()</code>	Establish a cleanup handler
<code>pthread_cleanup_pop()</code>	Remove a cleanup handler

## Thread stack attributes

Three attributes allow POSIX applications to control their threads' stack usage: `stackaddr`, `stacksize`, and `guardsize`.

The `stackaddr` attribute contains the address of application-provided storage to be used as the initial stack segment. This storage is referred to as an "application-managed stack".

The `stacksize` attribute controls the size of the stack. In an SUSv3 application, calls to `pthread_attr_setstacksize()` or `pthread_attr_setstack()` must provide a `stacksize` of at least `PTHREAD_STACK_MIN`. If not provided, the initial increment size is derived from the `STACK64/THREADSTACK64` runtime options in AMODE 64, or `STACK/THREADSTACK` otherwise.

When used in conjunction with application-managed stack, the size of the storage must be a multiple 4K on ILP32 (AMODE31) and 1M on L64 (AMODE64), and at least `PTHREAD_STACK_MIN` in length.

For portability, `pthread_attr_getguardsize()` and `pthread_attr_setguardsize()` may modify the `guardsize` in the thread attribute object, but the `guardsize` attribute is not honored on z/OS for system-managed stack. In the case of application-managed stack, guarding is an application responsibility.

The guardsize attribute is not honored on z/OS.

When a thread is created using an attribute object with a stackaddr attribute set, behavior is undefined if the application ever accesses the same storage again, except through normal stack access in that thread. An attribute object with stackaddr attribute set may not be used more than once, unless it is destroyed and re-initialized, or its stackaddr attribute changed.

---

## Behaviors and restrictions in z/OS UNIX applications

The following are implementation-specified behaviors and restrictions that apply to the XL C/C++ library functions when running a multi-threaded z/OS UNIX application.

### Using threads with MVS files

MVS files that are opened by data-set names or ddnames are thread-specific in the following ways:

MVS files opened in update mode where repositioning functions are used after the files have been extended are also restricted to the owning thread. This is because a reposition might need to reopen the read DCB in order to be able to see the new EOF marker. The runtime library does not enforce this restriction.

Multivolume data sets, files that are part of a concatenated ddname, and hiperspace memory files are further restricted in multithreaded applications. All I/O operations are restricted to the thread on which the file is opened.

When standard streams are directed to MVS files, they are governed by the previous restrictions. Standard streams are directed to MVS files in one of two ways:

- By default when a `main()` program is run from the TSO ready prompt or by a `JCL EXEC PGM=` statement, that is, whenever it is not initiated by the `exec()` function. This is regardless of whether you are running with `POSIX(ON)` or `POSIX(OFF)`. In these cases, the owning thread is the initial processing thread (IPT), the thread on which `main()` is executed.
- By explicit action when the user redirects the streams by using command line redirection, `fopen()`, or `freopen()`. The thread that is redirected (the IPT, if you are using command line redirection) becomes the owning thread of the particular standard stream. The usual MVS file thread affinity restrictions outlined above apply until the end of program or until the stream is redirected to the UNIX file system.

Any operation that violates these restrictions causes `SIGIOERR` to be raised and `errno` to be set with the following associated message:

```
EDC5024I: An attempt was made to close a file that had been
opened on another thread.
```

All MVS files opened from a given thread and still open when the thread is terminated are closed automatically by the library during thread termination.

Having more than one writer use separate file pointers to a single data set or ddname is prohibited as always, regardless of whether the file pointers are used from multiple threads or a single thread.



**Note:** These restrictions specifically do not apply to UNIX file system. All opens and closes by the C library that result in calls to an underlying access method for a given MVS file must occur on the same thread. Therefore, the following specific functions are prohibited from any thread except the owning thread (the one that does the initial `fopen()`) of the file:

- `fclose()`
- `freopen()`
- `rewind()`

## Multithreaded I/O

The `getc()`, `getchar()`, `putc()`, and `putchar()` functions have two versions, one that is defined in the header file, `stdio.h`, which is a macro and the other which is an actual library routine. The macros have better performance than their respective function versions, but these macros are not thread safe, so in a multithreaded application where `_OPEN_THREADS` feature test macro is defined, the macro version of these functions are not exposed. Instead, the library functions are used. This is done to ensure thread safety while multiple threads are executing.

The `getc_unlocked()`, `getchar_unlocked()`, `putc_unlocked()`, and `putchar_unlocked()` functions and macros are functionally equivalent to the `getc()`, `getchar()`, `putc()`, and `putchar()` functions and macros. These functions and macros can safely be used in a multi-thread environment if and only if called from a thread that owns the `FILE*` object, such as after a successful call to `flockfile()` or `ftrylockfile()`.

Use of the `getc_unlocked()`, `getchar_unlocked()`, `putc_unlocked()`, or `putchar_unlocked()` functions can have unpredictable behavior when used on a thread that has not locked the file.

It is the application's responsibility to prevent deadlocks or looping. For example, deadlock or looping may occur if a `FILE*` object is closed, or a thread is terminated, before relinquishing all locked `FILE*` objects

## Thread-scoped functions

Thread-scoped functions are functions that execute independently on each thread without sharing intermediate state information across threads. For example, `strtok()` preserves pointers to tokens independently on each thread, regardless of the fact that multiple threads may be examining the same string in a `strtok()` operation. Some examples of thread-scoped functions are:

- `strtok()`
- `rand()`, `srand()`
- `mblen()`, `mbtowc()`
- `strerror()`
- `asctime()`, `ctime()`, `gmtime()`, `localtime()`
- `clock()`

The following are examples of process-scoped functions, which means that a call to these functions on one thread influences the results of calls to the same function on another thread. For example, `tmpnam()` is required to return a unique name for every invocation during the life of the process, regardless of which thread issues the call.

- `tmpnam()`

- `getenv()`
- `setenv()`
- `clearenv()`
- `putenv()`

## Unsafe thread functions

The following functions are not thread-safe. In a multithreaded application, therefore, they should only be used before the first invocation of `pthread_create()`.

- `setlocale()` - (returns NULL if issued after `pthread_create()`)
- `tzset()`

## Fetches functions and writable statics

Fetches functions are recorded globally at the process level. Therefore, a function fetched from one thread can be executed from any thread.

Module boundary crossings are thread-scoped. Writable statics have a scope between process and thread. They are process-scoped except that module crossings are thread-scoped. This means that:

- All threads initially inherit the writable statics of the creating thread at the time of the creation.
- When any thread executes a function pointer supplied by the `fetch()` function and crosses a module boundary, only that thread has access to the writable statics of the fetched module.

## MTF and z/OS UNIX threading

MTF is not supported from applications running under `POSIX(ON)`. A return value of `EWRONGOS` is issued when running in a `POSIX(ON)` environment. An application that requires multithreading must either use MTF with `POSIX(OFF)` or `pthread_create()` with `POSIX(ON)`.

## Thread queuing function

The thread queuing function allows you to control whether or not threads should be queued up while waiting for TCBS to become available. You can accomplish this by switching the synctype attribute of a thread between synchronous and asynchronous mode. With synchronous mode for example, if a process can only have 50 TCBS active at any one time, then only 50 threads can be created. The 51st thread create results in an error. With asynchronous mode, however, you can set the synctype attribute for a thread such that the 51st thread is created. This thread will not start until one of the other threads finishes and releases a TCB.

Functions that relate to the ability to control thread queuing are:

- `pthread_set_limit_np()`
- `pthread_attr_getsynctype_np()`
- `pthread_attr_setsynctype_np()`

## Thread scheduling

You can use the `pthread_attr_setweight_np()` and `pthread_attr_setsynctype_np()` functions to establish priorities for threads. The `pthread_attr_setweight_np()` *threadweight* variable can be set to the following:

### **\_\_MEDIUM\_WEIGHT**

Each thread runs on a task. When the current thread exits, the task waits for another thread to do a `pthread_create()`. The new thread runs on that task.

### **\_\_HEAVY\_WEIGHT**

The task is attached on `pthread_create()` and terminates when the thread exits. When the thread exits, the associated task can no longer request threads to process, and full MVS EOT resource manager cleanup occurs.

You can use the `pthread_attr_t` structure and the `pthread_attr_t::set_tosynctype_np()` function to set the `__PTATASYNCHRONOUS` value. This enables you to create more threads than there are TCBS available. For example, you could run 50 TCBS and create hundreds of threads. The kernel queues the threads until a task is available. This frees your application from managing the work. While a thread is queued and not executing on an MVS task, you can still interact with the thread via `pthread` functions, such as `pthread_join()` and `pthread_kill()`.

## **iconv() family of functions**

The conversion descriptor returned from a successful `iconv_open()` may be used safely within a single thread for conversion purposes. It may, however, be opened on one thread (`iconv_open()`), closed on another thread (`iconv_close()`), and used on a third thread (`iconv()`). However, it is the user's responsibility to ensure operations are synchronized if they are used across multiple threads.

**Note:** The `iconv_open()` function tolerates converter names without a dash in the name for all converter names containing dashes. For example, `iconv_open()` tolerates the name `IBM1047` for the `IBM-1047` converter.

## **Threads and recoverable resources**

When a Language Environment application terminates with an ABEND, outstanding updates to recoverable resources are rolled back for all contexts that are associated with the initial `pthread`-creating task (IPT) and any `pthread_created` tasks that are active.

When a Language Environment application terminates normally or with a nonzero return code, outstanding updates to recoverable resources are committed for all contexts that are associated with the initial `pthread`-creating task (IPT) and any `pthread_created` tasks that are active.

---

## Chapter 25. Reentrancy in z/OS XL C/C++

This information describes the concept of reentrancy. It tells you how to use reentrancy in C programs to help make your programs more efficient, and how C++ achieves constructed reentrancy.

Reentrant programs are structured to allow multiple users to share a single copy of an executable module or to use an executable module repeatedly without reloading. C and C++ achieve reentrancy by splitting your program into two parts, which are maintained in separate areas of memory until the program terminates:

- The first part, which consists of executable code and constant data, does not change during program execution.
- The second part contains persistent data that can be altered. This part includes the dynamic storage area (DSA) and a piece of storage known as the writable static area.

For XPLINK, the writable static area is further logically subdivided into areas called environments. Environments are optional, and each function can have its own environment. When an XPLINK function is called, the caller must load general purpose register 5 with the address of the environment of the called function before control is given to the entry point of the called function.

If the program is installed in the Link Pack Area (LPA) or Extended Link Pack Area (ELPA) of your operating system, only a single copy of the first (constant or reentrant) part exists within a single address space. This occurs regardless of the number of users that are running the program simultaneously. This reentrant part may be shared across address spaces or across sessions. In this case, the executable module is loaded only once. Separate concurrent invocations of the program share or reenter the same copy of the write-protected executable module. If the program is not installed in the LPA or ELPA area, each invocation receives a private copy of the code part, but this copy may not be write-protected.

The modifiable writable static part of the program contains:

- All program variables with the `static` storage class
- All program variables receiving the `extern` storage class
- All writable strings
- All function linkage descriptors for all referenced DLL functions
- Function linkage descriptors for all referenced DLL functions that are used by multiple compilation units in the program, but are not imported (XPLINK, RENT)
- All variable pointers for imported variables (non-XPLINK)
- All function pointers for imported functions (XPLINK, RENT)
- All variable linkage descriptors to reference imported variables (non-XPLINK)

Each user running the program receives a private copy of the second (data or non-reentrant) part. This part, the data area, is modifiable by each user.

The code part of the program contains:

- Executable instructions
- Read-only constants

- Global objects compiled with the `#pragma variable(identifier, NORENT)`

**Note:** The ROCONST compiler option implicitly inserts a `#pragma variable(identifier, NORENT)` for const qualified variables.

---

## Natural or constructed reentrancy

### Natural reentrancy

C programs that contain no references to the writable static objects listed in a previous section have natural reentrancy. You do not need to compile naturally reentrant C programs with the RENT compiler option or bind them with the binder.

### Constructed reentrancy

C++ programs, and C programs that contain references to writable static objects, can have constructed reentrancy. You must bind these programs with the binder. For C programs, you must use the RENT compiler option.

If you use the XPLINK option, RENT is the default. If you override this default by specifying NORENT, any parts of the program that are normally stored in the writable static area go instead into a static area. If this static area is write-protected, you will get a runtime failure because the function pointers for imported functions cannot be modified to point to the function when the DLL containing the function is loaded and the function address determined. For programs that are both XPLINK and NORENT, all functions must be statically bound or explicitly loaded (`dllload()`, or `fetch()`).

## Limitations of constructed reentrancy for C programs

Even if a C program is large and will have more than one user at the same time, there are also these limitations to consider:

- The binder is required for code that you compile with XPLINK.
- If the prelinker, rather than the binder, will process code that is compiled with NOXPLINK, RENT:
  - The resultant load module referring to the writable area cannot be reprocessed.
  - The resultant program may reside in a PDS.
- If the binder is used, and not the prelinker, the resultant program must reside in a PDSE or UNIX file system. If a PDSE member should be installed into LPA or ELPA, it can only be installed into dynamic LPA.
- A system programmer can install only the shared portion of your program in the LPA or ELPA of your operating system.

---

## Controlling external static in C programs

Certain program variables with the `extern` storage class may be constant and never written. If this is the case, every user does not need to have a separate copy of these variables. In addition, there may be a need to share constant program variables between C and another language.

You can force an external variable to be the part of the program that includes executable code and constant data by using the `#pragma variable(varname, NORENT)` directive. The program fragment in Figure 100 on page 371 illustrates how this is accomplished.

---

```
#pragma options(RENT)

#pragma variable(rates, NORENT)
extern float rates[5] = { 3.2, 83.3, 13.4, 3.6, 5.0 };

extern float totals[5];

int main(void) {
    /* ... */
}
```

---

*Figure 100. Controlling external static*

In this example, the source file is compiled with the RENT option. The external variable `rates` are included in the executable code because `#pragma variable(rates, NORENT)` is specified. The variable `totals` are included with the writable static. Each user has a copy of the array `totals`, and the array `rates` are shared among all users of the program.

The `#pragma variable(varname, NORENT)` does not apply to, and has no effect on, program variables with the `static` storage class. Program variables with the `static` storage class are always included in the writable static. An informational message will appear if you do try to write to a non-reentrant variable when you specify the `CHECKOUT` compiler option.

When specifying `#pragma variable(varname, NORENT)`, ensure that this variable is never written; if it is written, program exceptions or unpredictable program behavior may result. In addition, you must include `#pragma variable(varname, NORENT)` in every source file where the variable is referenced or defined. It is good practice to put these pragmas in a common header file.

**Note:** You can also use the keyword `const` to ensure that a variable is not written. See the `const` type qualifier in *z/OS XL C/C++ Language Reference* for more information.

The `ROCONST` compiler option has the same effect as specifying the `#pragma variable (var_name, NORENT)` for all constant variables (i.e. `const` qualified variables). The option gives the compiler the choice of allocating `const` variables outside of the Writable Static Area (WSA). For more information, see `ROCONST` | `NORCONST` in *z/OS XL C/C++ User's Guide*.

## Controlling writable strings

In a large number of C programs, character strings may be constant and never written to. If this is the case, every user does not need a separate copy of these strings.

You can force all strings in a given source file to be the part of the program that includes executable code and constant data by using `#pragma strings(readonly)` or the `ROSTRING` compiler option. Figure 101 on page 372 illustrates one way to make the strings constant.

Figure 101 on page 372 shows a sample program (CCNGRE1) that makes strings constant. The string `"hello world\n"` is included with the executable code because `#pragma strings(readonly)` is specified. This can yield a performance and storage benefit.

---

```

/* this example demonstrates how to make strings constant */

#pragma strings(readonly)
#include <stdio.h>

int main(void)
{
    printf("hello world\n");

    return(0);
}

```

---

*Figure 101. Making strings constant*

Ensure that you do not write to read-only strings. The following code tries to overwrite the literal string "abcd" because 'chrs' is just a pointer:

```

char chrs[] = "abcd";
memcpy(chrs, "ABCD", 4);

```

Program exceptions or unpredictable program behavior may result if you attempt to write to a string constant.

The ROSTRING compiler option has the same effect as #pragma strings(readonly) in the program source. For more information, see ROSTRING | NOROSTRING in *z/OS XL C/C++ User's Guide*.

## Controlling the memory area in C++

In C++, some objects may be constant and never modified. If your program is reentrant, having such objects exist in the code part is a storage and performance benefit.

As a programmer, you control where objects with global names and string literals exist. You can use the #pragma variable(objname, NORENT) directive to specify that the memory for an object with a global name is to be in the code area. You can use the ROCONST compiler option to specify that all const variables go into the code area.

In Figure 102, the variable RATES exists in the executable code area because #pragma variable(RATES, NORENT) has been specified. The variable totals exists in writable static area. All users have their own copies of the array totals, but the array RATES is shared among all users of the program.

---

```

/*-----*/
/* RATES is constant and in code area */
#pragma variable(RATES, NORENT)
const float RATES[5] = { 1.0, 1.5, 2.25, 3.375, 5.0625 };
float totals[5];
/*-----*/

```

---

*Figure 102. Example of controlling the memory area*

When you specify #pragma variable(objname, NORENT) for an object, and the program is to be reentrant, you must ensure that this object is never modified, even by constructors or destructors. Program exceptions or unpredictable behavior may result. Also, you must include #pragma variable(objname, NORENT) in every



source file where the object is referenced or defined. Otherwise, the compiler will generate inconsistent addressing for the object, sometimes in the code area and sometimes in the writable static area.

---

## Controlling where string literals exist in C++ code

In z/OS XL C/C++, the string literals exist in the code part by default, and are not modifiable if the code is reentrant. In a large number of programs, string literals may be constant. In this case, every user does not need a separate copy of these strings.

By using the `#pragma strings(writable)` directive, you can ensure that the string literals for that compilation unit will exist in the writable static area and be modifiable. Figure 103, which shows sample program CCNGRE2, illustrates how to make the string literals modifiable.

---

```
/* this example demonstrates how to make string literals modifiable */

#pragma strings(writable)
#include <iostream.h>
int main(void)
{
    char * s;
    s = "wall\n";      // point to string literal
    *(s+3) = 'k';     // modify string literal
    cout << s;        // output "walk\n"
}

```

---

*Figure 103. How to Make String Literals Modifiable*

In this example, the string "wall\n" will exist in the writable static area because `#pragma strings(writable)` is specified. This modifies the fourth character.

---

## Using writable static in Assembler code

Programming in C or C++ can eliminate most of the need to code in assembler. However, in cases where you must code in assembler, you may have a need to modify data in the writable static area of a C or C++ program, from within an assembler program.

### Notes:

1. To call assembler from C++, you must use `extern "OS"` as documented in Chapter 19, "Using Linkage Specifications in C or C++," on page 239.
2. The following macros, and access to writable static data from assembler are not supported for XPLINK programs.
  - EDCDXD
  - EDCLA
  - EDCDPLNK

One way to modify data in the writable static area is to pass the address of the writable static data item as a parameter to the assembler program. This may be difficult in some cases. The following assembler macros makes this easier:

- EDCDXD
- EDCLA
- EDCDPLNK



These are in CEE.SCEEMAC(EDCDXD,EDCLA,EDCDPLNK). The restriction on the names of writable static objects accessible in assembler code is that they are S-names. This means that they may be at most 8 characters long and may contain only characters allowed in external names by the assembler code.

The macro EDCDXD declares a writable static data item. EDCLA loads the address of the writable static data item into a register. Using the EDCLA macro in assembler code necessitates coding EDCDXD as well.

The EDCDPLNK macro defines reference writable static data with the z/OS binder. This macro must appear before the first executable control section is initiated in the assembler source module. If there is more than one assembler source program in the input file, EDCDPLNK must precede every assembler source program in any input file that defines or references writable static data. Figure 104 illustrates their use.

---

```

*****
* this example shows how to reference objects in the writable      *
* static area, from assembler code                                *
* part 1 of 2(other file is CCNGRE4)                             *
*                                                                  *
* parameters: none                                              *
* return:      none                                             *
* action:      store contents of register 13 ( callers dynamic   *
*              storage area) in variable DSA which exists in    *
*              the writable static area                          *
*                                                                  *
* Macros:      EDCPRLG, EDCEPIL, EDCDXD, EDCLA in CEE.SCEEMAC   *
*****
XOBJHDR  EDCDPLNK                ;generate an XOBJ header
GETDSA   CSECT
GETDSA   AMODE ANY
GETDSA   RMODE ANY
          EDCPRLG                ;prolog (save registers etc.)
          EDCLA 1,DSA             ;load register 1 with address of DSA
          ST 13,0(,1)            ;store contents of reg 13 in DSA
          EDCEPIL                ;epilog (restore registers etc.)
DSA      EDCDXD 0F               ;declaration of DSA  in writable static
TBLDSA   EDCDXD 20F              ;definition of TBLDSA in writable static
END

```

---

*Figure 104. Referencing objects in the writable static area, Part 1*

In this example, the external variable TBLDSA is declared using the EDCDXD macro. The size value of 0F (zero fullwords) indicates that DSA will be treated as an extern declaration in C or C++. Because TBLDSA is an extern declaration and not a definition, DSA must be defined in another C, C++, or assembler program. The EDCLA macro loads the general purpose register 1 with the address of DSA, which exists in the writable static area.

The external variable TBLDSA is declared using the EDCDXD macro. It is defined because its size is 20F (20 fullwords or 80 bytes) and corresponds to an external data definition in C or C++. When the program starts, TBLDSA is initialized to zero. Because TBLDSA is an external data definition, there should not be another definition of it in a C++, C, or assembler program.

When these macros are used, these pseudo-registers cannot be used within the same assembler program.

There are no assembler macros for static initialization of a variable with a nonzero value. You can do this by defining and initializing the variable in C or C++ and making an extern declaration for it in the assembler program. In the example assembler program, DSA is declared this way.

Figure 105 shows sample program CCNGRE4, which illustrates how to call the assembler program in Figure 104 on page 374.

---

```
/* this example shows how to reference objects in the writable */
/* static area, from assembler code */
/* part 2 of 2 (other file is CCNGRE3) */

#include <stdio.h>

#ifdef __cplusplus
    extern "OS" {
#endif
void GETDSA(void);          /* assembler routine modifies DSA */
#ifdef __cplusplus
    }
#endif

const int sz = 20;          /* maximum call depth */
extern void * TBLDSA[sz];   /* defined in assembler program */
void * DSA;                 /* define it here, source name */
                            /* same as assembler name */

/* call yourself deeper and deeper */
/* save DSA pointers as you go */
void deeper( int i)
{
    if (i >= sz)           /* if deep enough just return */
        return;
    GETDSA();              /* assign value to DSA */
    TBLDSA[i] = DSA;       /* save value in table */
    deeper(i+1);           /* go deeper in call chain */
}

int main(void) {
    int i;
    deeper(0);
    for(i=0; i<sz; i++)
        printf("depth %3d, DSA was at %p\n", i, TBLDSA[i]);
    return 0;
}
```

---

Figure 105. Referencing objects in the writable static area, Part 2



---

## Chapter 26. Using decimal data types in C

This information refers to fixed-point decimal data types as *decimal data types*. The decimal data type is an extension of the ANSI C language definition. When using the decimal data types, you must include the `decimal.h` header file in your source code. That header file specifies the value of `DEC_DIG`, which sets the maximum length allowed for expressions, in significant digits, including integral and fractional parts.

Decimal data types are available only if the `LANGlvl` is `EXTENDED` by specifying the `LANGlvl(EXTENDED)` compiler option. For more information, see `LANGlvl` in *z/OS XL C/C++ User's Guide*.

You can use decimal data types to represent large numbers accurately, especially in business and commercial applications for financial calculations. You can pass decimal arguments in function calls and in `define` macros. You can also declare decimal variables, data type definitions, arrays, structures, and unions that have decimal members.

When you use decimal variables, the following operators apply:

- Arithmetic
- Relational
- Assignment
- Comma
- Conditional
- Equality
- Logical
- Primary
- Unary

---

### Decimal data type declarations

Use the type specifier `decimal(n,p)` to declare decimal variables and initialize them with fixed-point decimal constants. The `decimal()` macro is defined in `<decimal.h>`. The `decimal(n,p)` type specifier designates a decimal number with *n* digits and *p* decimal places. In this specifier, *n* is the total number of digits for the integral and decimal parts combined and *p* is the number of digits for the decimal part only. For example, `decimal(5,2)` represents a number, such as 123.45, where *n*=5 and *p*=2. Specifying the value for *p* is optional. If not specified, *p* has a default value of 0. *n* and *p* have a range of allowed values according to the following rules:

$$\begin{aligned} p &\leq n \\ 1 &\leq n \leq \text{DEC\_DIG} \\ 0 &\leq p \leq \text{DEC\_PRECISION} \end{aligned}$$

**Note:** The header file `decimal.h` defines `DEC_DIG` (the maximum number of digits *n*) and `DEC_PRECISION` (the maximum precision *p*). Currently, there is a limit of a maximum of 31 digits.

## Declaring fixed-point decimal constants

The syntax for fixed-point decimal constants is shown in Table 76.

Table 76. Declarations of fixed-point decimal constants

Data type	Syntax
fixed-point-decimal-constant	Use the following format: fractional-c onstant fixed-point-decimal-suffix
fractional-constant	Use any one of the following formats: digit-sequence . digit-sequence . digit-sequence digit-sequence . digit-sequence
digit-sequence	Use any one of the following formats: digit digit-sequence digit
fixed-point-decimal-suffix	Use any one of the following formats: D d

A fixed-point decimal constant has a numeric part and a suffix that specifies its data type. The components of the numeric part may include a digit sequence representing the integral part, followed by a decimal point (.), followed by a digit sequence representing the fractional part. Either the integral part, the fractional part, or both are present.

Each fixed-point decimal constant has the attributes *number of digits* (digits) and *number of decimal places* (precision). Leading or trailing zeros are not discarded when the digits and the precision are determined.

Table 77 gives examples of fixed-point decimal constants and their corresponding attributes:

Table 77. Examples of Fixed-Point decimal constants and their attributes

Fixed-Point Decimal Constant	(digits, precision)
1234567890123456D	( 16, 0 )
12345678.12345678D	( 16, 8 )
12345678.d	( 8, 0 )
.1234567890d	( 10, 10 )
12345.99d	( 7, 2 )
000123.990d	( 9, 3 )
0.00D	( 3, 2 )

## Declaring decimal variables

The following example shows how you can declare a variable as a decimal data type:



---

## Using operators on decimal data types

You can use arithmetic, relational, assignment, comma, conditional, equality, logical, primary, and unary cast operators on a decimal data type. Conversions follow these arithmetic conversion rules:

- First, if the type of either operand is long double, the other operand becomes long double.
- Otherwise, if the type of either operand is double, the other operand becomes double.
- Otherwise, if the type of either operand is float, the other operand becomes float.
- Otherwise, if the type of either operand is decimal, the other operand becomes decimal.
- Otherwise, the integral promotions are performed on both operands. Then the following rules are applied:
  - If the type of either operand is unsigned long int, the other operand becomes unsigned long int.
  - Otherwise, if the type of one operand is long int and the other is unsigned int, the operand of type unsigned int is converted to long int, if the long int can represent all values of an unsigned int. If a long int cannot represent all the values of an unsigned int, both operands become unsigned long int.
  - Otherwise, if the type of either operand is long int, the other operand becomes long int.
  - Otherwise, if the type of either operand is unsigned int, the other operand becomes unsigned int.
  - Otherwise, the type of both operands is int.

### Arithmetic operators

Figure 106 on page 381 shows how to use arithmetic operators, and then describes certain arithmetic, assignment, unary, and cast operators in more detail. It summarizes how to add, subtract, multiply and divide decimal variables.

---

```

/*this example demonstrates arithmetic operations on decimal variables*/

#include <decimal.h>          /* decimal header file */
#include <stdio.h>

int main(void)
{

decimal(10,2) op_1 = 12d;
decimal(5,5) op_2 = -.12345d;
decimal(24,12) op_3 = 12.34d;
decimal(20,5) op_4 = 11.01d;
decimal(14,5) res_add;
decimal(25,2) res_sub;
decimal(15,7) res_mul;
decimal(31,14) res_div;

res_add = op_1 + op_2;
res_sub = op_3 - op_1;
res_mul = op_2 * op_1;
res_div = op_3 / op_4;

printf("res_add =%D(*,*)\n",digitsof(res_add),
      precisionof(res_add),res_add);
printf("res_sub =%D(*,*)\n",digitsof(res_sub),
      precisionof(res_sub),res_sub);
printf("res_mul =%D(*,*)\n",digitsof(res_mul),
      precisionof(res_mul),res_mul);
printf("res_div =%D(*,*)\n",digitsof(res_div),
      precisionof(res_div), res_div);

return(0);
}

```

---

Figure 106. Arithmetic operators example

## Additive operators

Additive and multiplicative operators follow the arithmetic conversion rules defined in “Using operators on decimal data types” on page 380.

**Note:** For performance reasons, generating negative zero is possible.

Refer to “Intermediate results” on page 382 for details on how to get the conversion type during alignment of the decimal point.

## Relational operators

Relational operators follow the arithmetic conversion rules defined in “Using operators on decimal data types” on page 380.

Figure 107 on page 382 shows you how to use a relational expression less than (<) for decimals. In this example, decimal data types are compared with other arithmetic data types (integer, float, double, long double). In addition, the implicit conversion of the decimal data types is performed using the arithmetic conversion rules in “Converting decimal types” on page 385. Leading zeros in the example are shown to indicate the number of digits in the decimal data type. You do not need to enter leading zeros in your decimal data type variable initialization. Refer to “Intermediate results” on page 382 for details on how to get the conversion type during alignment of the decimal point.



---

```

/* this example shows how to use a relational expression with the */
/* decimal type */

#include <decimal.h>

decimal(10,3) pdval = 0000023.423d; /* Decimal declaration*/
int ival = 1233; /* Integer declaration*/
float fval = 1234.34; /* Float declaration*/
double dval = 251.5832; /* Double declaration*/
long double lval = 37486.234; /* Long double declaration*/

int main(void)
{
    decimal(15,6) value = 000485860.085999d;
    /*Perform relational operation between other data types and decimal*/
    if (pdval < ival) printf("pdval is the smallest !\n");
    if (pdval < fval) printf("pdval is the smallest !\n");
    if (pdval < dval) printf("pdval is the smallest !\n");
    if (pdval < lval) printf("pdval is the smallest !\n");
    if (pdval < value) printf("pdval is the smallest !\n");

    return(0);
}

```

---

Figure 107. Relational operators example

## Equality operators

Equality operators follow the arithmetic conversions defined in “Using operators on decimal data types” on page 380. Where the operands have data types and values suitable for the relational operators, the semantics for relational operators applies.

**Note:** Positive zero and negative zero compare equal. In the following example, the expression always evaluates to TRUE:

```
(-0.00d == +0.00000d)
```

Refer to “Intermediate results” for details on how to get the conversion type during alignment of the decimal point.

## Conditional operators

Conditional operators follow the arithmetic conversions defined in “Using operators on decimal data types” on page 380. If both the second and third operands have an arithmetic data type, the usual arithmetic conversions are performed to bring them to a common data type. If both operands are decimal data types, the operands are converted to the conversion type and the result has that data type.

Refer to “Intermediate results” for details on how to get the conversion type during alignment of the decimal point.

## Intermediate results

Use one of the following tables to calculate the size of the result. The tables summarize the intermediate expression results with the four basic arithmetic operators and conditional operators when applied to the decimal data types. Most of the time, you can use Table 78 on page 383 to calculate the size of the result. It assumes no overflow. If overflow occurs, use Table 79 on page 383 to determine the resulting data type.

Both tables assume the following:

- $x$  has data type  $\text{decimal}(n_1, p_1)$
- $y$  has data type  $\text{decimal}(n_2, p_2)$
- $\text{decimal}(n, p)$  is the resulting data type

Table 78. Intermediate results (without overflow in  $n$  or  $p$ )

Expression	( $n, p$ )
$x * y$	$n = n_1 + n_2$ $p = p_1 + p_2$
$x / y$	$n = \text{DEC\_DIG}$ $p = \text{DEC\_DIG} - ((n_1 - p_1) + p_2)$
$x + y$	$p = \max(p_1, p_2)$ $n = \max(n_1 - p_1, n_2 - p_2) + p + 1$
$x - y$	same rule as addition
$z ? x : y$	$p = \max(p_1, p_2)$ $n = \max(n_1 - p_1, n_2 - p_2) + p$

You can use Table 79 to calculate the size of the result, whether there is an overflow or not.

Table 79. Intermediate results (in the general form)

Expression	( $n, p$ )
$x * y$	$n = \min(n_1 + n_2, \text{DEC\_DIG})$ $p = \min(p_1 + p_2, \text{DEC\_DIG} - \min((n_1 - p_1) + (n_2 - p_2), \text{DEC\_DIG}))$
$x / y$	$n = \text{DEC\_DIG}$ $p = \max(\text{DEC\_DIG} - ((n_1 - p_1) + p_2), 0)$
$x + y$	$ir = \min(\max(n_1 - p_1, n_2 - p_2) + 1, \text{DEC\_DIG})$ $p = \min(\max(p_1, p_2), \text{DEC\_DIG} - )$ $n = ir + p$
$x - y$	same rule as addition
$z ? x : y$	$ir = \max(n_1 - p_1, n_2 - p_2)$ $p = \min(\max(p_1, p_2), \text{DEC\_DIG} - ir)$ $n = ir + p$

If overflow occurs in  $n$  or  $p$ , a compile-time warning message is issued and the decimal places are truncated. As much of the integral part is reserved as possible. If the integral part is truncated as an expression in the static or extern initialization, an error message is issued. If the integral part is truncated inside the block scope, a warning is issued. On each operation, the complete result is calculated before truncation occurs.

## Assignment operators

Assignment operators follow the arithmetic conversion rules defined in “Using operators on decimal data types” on page 380. When values are assigned, an SIGFPE exception may be raised if the operands contain values that are not valid.

## Unary operators

Use the following unary operators to determine the digits in a decimal data type:

**sizeof** Determines the total number of bytes occupied by the decimal data type

**digitsof**

Determines the number of digits ( $n$ )

### **precisionof**

Determines the number of decimal digits ( $p$ )

### **sizeof operator**

When you use the sizeof operator with decimal ( $n,p$ ), the result is an integer constant. The sizeof operator returns the total number of bytes occupied by the decimal data type.

Each decimal digit occupies a halfbyte. In addition, a halfbyte represents the sign. The number of bytes used by decimal ( $n,p$ ) is the smallest whole number greater than or equal to  $(n + 1)/2$ , that is,  $\text{sizeof}(\text{decimal}(n,p)) = \text{ceil}((n + 1)/2)$ . The sizeof result is calculated using this method because the z/OS XL C compiler uses packed decimal to implement decimal data types.

Figure 108 shows an example of getting the total number of bytes occupied by the decimal data type.

---

```
int y;
decimal (5, 2) x;
y = sizeof x;      /* This would be calculated to be 3 bytes*/
                  /* (5+1)/2 = 3.                               */
```

---

*Figure 108. Getting the total number of bytes occupied by the decimal data type*

### **digitsof operator**

When you use the digitsof operator with a decimal type, the result is an integer constant. The digitsof operator returns the number of significant digits ( $n$ ) in a decimal type.

Figure 109 shows an example of getting the total number of bytes occupied by the decimal data type. This example gives you the number of digits ( $n$ ) in a decimal type.

---

```
decimal (5, 2) x;
int n;
n = digitsof x; /* the result is n=5 */
```

---

*Figure 109. Getting the total number of digits in the decimal data type*

**Note:** Apply digitsof only to a decimal type.

### **precisionof operator**

When you use the precisionof operator with a decimal type, the result is an integer constant. The precisionof operator tells you the number of decimal digits ( $p$ ) of the decimal type.

Figure 110 on page 385 shows an example of getting the number of decimal digits in the decimal data type. This example gives you the number of decimal digits ( $p$ ) of the decimal data type.

---

```

decimal (5, 2) x;
int p;
p = precisionof x; /* the result is p=2 */

```

---

Figure 110. Getting the number of decimal digits in the decimal data type

**Note:** Apply `precisionof` only to a decimal data type.

### cast operator

You can use the cast operator convert the following types explicitly:

- Decimal types to decimal types
- Decimal types to and from floating-point types
- Decimal types to and from integer types

#### Notes:

1. When you are explicitly casting to a decimal type, the discarding of the leading nonzero digits does not cause an exception at run time. For more information about suppressing compiler messages and runtime exceptions, refer to “Converting decimal types.”
2. An implicit conversion to a decimal type with an even number of digits may not clear the pad digit, but an explicit cast will clear the pad digit.

## Summary of operators used with decimal types

Table 80 summarizes all of the operators that can be used with decimal types.

Table 80. Operators used with decimal data types

Operator Name	Associativity	Operators
Primary	left to right	()
Unary	right to left	++ -- + - ! & ( typename ) sizeof digitsof precisionofcast
Multiplicative	left to right	* /
Additive	left to right	+ -
Relational	left to right	< > <= >=
Equality	left to right	== !=
Conditional	right to left	? :
Assignment	right to left	= += -= *= /=
Comma	left to right	,

---

## Converting decimal types

The z/OS XL C compiler implicitly converts the following types:

- Decimal types to decimal types
- Decimal types to and from floating-point types
- Decimal types to and from integer types

### Converting decimal types to decimal types

If the value of the decimal type to be converted is within the range of values that can be represented exactly, the value of the decimal type is not changed.

If the value of the decimal type to be converted is outside the range of values that can be represented, the value of the decimal type is truncated. Truncation may occur on either the integral part or the fractional part or both.

When truncation occurs on the fractional part, no compile-time message or runtime exception occurs.

When truncation occurs on the integral part, a compile-time message, a runtime exception, or both, are generated as follows:

- In the initialization of static or external variables
  - Compile-time error if nonzero digits are truncated in the integral part
- In the initialization of automatic variables, an assignment or function call with prototype
  - Checkout warning at compile time
  - Runtime exception SIGFPE may occur if nonzero digits are truncated in the integral part at run time.

**Note:** An explicit cast is used to suppress compile-time messages and runtime exceptions. A runtime exception may occur if any leading nonzero digits are discarded and the operation is not an explicit cast operation.

In the following examples:

- message represents a compile-time message.
- exception represents a runtime exception (that is, SIGFPE is raised).

Figure 111 shows an example of fractional part that cannot be represented. Conversion of one decimal object to another decimal object with smaller precision involves truncation on the right of the decimal point.

---

```
#include <decimal.h>

void func(void);
void dec_func(decimal( 7, 1 ));
decimal( 7, 4 ) x = 123.4567D;
decimal( 7, 1 ) y;
decimal( 7, 1 ) z = 123.4567D; /* z = 000123.4D <-- No message, */
                             /*                               No exception */

void func(void) {
    decimal( 7, 1 ) a = 123.4567D; /* a = 000123.4D <-- No message, */
                                /*                               No exception */
    y = x;                       /* y = 000123.4D <-- No message, No exception */
    y = 123.4567D;               /* y = 000123.4D <-- No message, No exception */
    dec_func(x);                 /* <-- No message, No exception */
}
```

---

*Figure 111. Fractional part cannot be represented*

Figure 112 on page 387 shows an example of an integral part that cannot be represented. Conversion of one decimal object to another decimal object with fewer digits involves truncation on the left of the decimal point.

---

```

void func(void);
void dec_func(decimal( 5, 2 ));
decimal( 8, 2 ) w = 000456.78D;
decimal( 8, 2 ) x = 123456.78D;
decimal( 5, 2 ) y;
decimal( 5, 2 ) z = 123456.78D; /* <-- Compile-time error */
decimal( 5, 2 ) z1 = (decimal( 5, 2 )) 123456.78D;
/* z1 = 456.78D <-- No message, */
/* No exception */

void func(void) {
    decimal( 5, 2 ) a = 123456.78D; /* <-- Checkout warning */
/* and exception */
    decimal( 5, 2 ) a1 = (decimal( 5, 2 )) 123456.78D;
/* a1 = 456.78D <-- No message, */
/* No exception */
    y = w; /* y = 456.78D <-- Checkout warning, No exception */
    y = x; /* <-- Checkout warning and exception */
    y = 123456.78D; /* <-- Checkout warning and exception */
    dec_func(x); /* <-- Checkout warning and exception */

    y = (decimal( 5, 2 )) w;
/* y = 456.78D <-- No message, No exception */
    y = (decimal( 5, 2 )) x;
/* y = 456.78D <-- No message, No exception */
    y = (decimal( 5, 2 )) 123456.78D;
/* y = 456.78D <-- No message, No exception */
    dec_func((decimal( 5, 2 )) x);
/* <-- No message, No exception */
}

```

---

Figure 112. Integral part cannot be represented

## Converting decimal types to and from integer types

The following topics provide examples and information that is useful when you are converting decimal data types to or from integer data types:

- “Conversion to integer types”
- “Conversion from integer types” on page 388

### Conversion to integer types

When a value of decimal type is converted to integer type, the fractional part is discarded. If the value of the integral part cannot be represented by the integer type, the behavior is undefined.

When a negative decimal type is converted to an unsigned integer type, the conversion proceeds as though these steps are followed:

1. The decimal type is converted to a signed integer type with the same size as the unsigned integer type.
2. The signed integer type is converted to the unsigned integer type.

Figure 113 is an example of a conversion to integer type.

---

```

int i = 1234.5678d; /* i = 1234 */
int j = -789d; /* j = -789 */
int k = 9876543210d; /* k is undefined */

```

---

Figure 113. Conversion to integer type

## Conversion from integer types

When a value of integer type is implicitly converted to decimal type, the integer type is converted to type `decimal(10,0)`.

When a value of integer type is explicitly converted to decimal type, the conversion proceeds as though these two steps are followed:

1. The integer type is converted to type `decimal(10,0)`. A runtime exception can never occur in this step.
2. Type `decimal(10,0)` is then converted to `decimal(n,p)`. All rules for decimal type to decimal type conversion apply in this step.

An unsigned integer type is converted to a positive decimal value.

If the value of the integral part cannot be represented by the decimal type, the behavior is undefined.

Figure 114 is an example of conversion from integer type.

---

```
#include <decimal.h>

decimal(10,2) pd01 = 1234;    /* pd01 = 00001234.00d */
decimal(5,0) pd02 = 987654;  /* compile-time error */
int main(void) {
    decimal(5,0) pd03 = 987654; /* runtime exception */
    decimal(13,4) pd04;

    /* The number 321 is converted to decimal(10,0) before the */
    /* addition is performed. */
    pd04 = 1234.56d + 321;    /* pd04 = 000001555.5600d */
}
```

---

Figure 114. Conversion from integral type

## Converting decimal data types to and from floating-point data types

The following topics provide examples and information that is useful when you are converting decimal data types to or from floating-point data types:

- “Conversion to floating-point types”
- “Conversion from floating-point data types” on page 389

### Conversion to floating-point types

The result of the conversion might not be exact due to:

- The limitations of significant digits in different floating-point types
- The degree to which a value can be stored exactly in a floating-point type
- The loss of precision during conversion

Figure 115 on page 389 is an example of conversion to floating-point type. The content of each floating-point type variable depends on their limitation of significant digits that are specified in `<float.h>`.

---

```
float      a = 12345678901234567890.1234567890d;  
double    b = 12345678901234567890.1234567890d;  
long double c = 12345678901234567890.1234567890d;
```

---

Figure 115. Conversion to floating-point type

## Conversion from floating-point data types

When a value of floating-point type is converted to decimal type and the value being converted cannot be represented by the decimal type, the result is rounded towards zero. If the value of the floating-point type to be converted is within the range of values that can be represented, but cannot be represented exactly, the result is also rounded towards zero. The result retains as much value as possible. When any leading nonzero digits are suppressed and the operation is not an explicit cast operation, a decimal overflow exception occurs at run time and a SIGFPE exception is raised.

When a conversion from a floating-point type is made with static or external variable initialization, a compile-time error message is issued.

The result of the conversion may not be exact because the internal representation of System/370 floating-point instructions is hexadecimal based if `FLOAT(HEX)` mode is used. The mapping between the two representations is not one-to-one, even when the value of a float type is within the range of the decimal type. Figure 116 is an example of conversion from floating-point type.

---

```
#include <decimal.h>  
  
decimal(10,2) pd11 = 1234.0; /* pd11 = 00001234.00d */  
decimal(5,0) pd12 = 987654.0; /* compile-time error */  
int main(void) {  
    decimal(5,0) pd13 = 987654.0; /* runtime exception */  
    decimal(13,4) pd14 = 12.34567890; /* fractional part is truncated */  
}
```

---

Figure 116. Conversion from floating-point type

---

## Calling functions with decimal data types

There are no default argument promotions on arguments that have type decimal when the called function does not include a prototype. If the expression for the called function has a type that includes a prototype, the behavior is as documented in ANSI, with the exception of prototype with an ellipsis (...). If the prototype ends with an ellipsis (...), default argument promotions are not performed on arguments with decimal types.

A function may change the values of its parameters, but these changes cannot affect the values of the arguments. However, it is possible to pass a pointer to a decimal object, and the function may change the value of the decimal object to which it points.

---

## Using library functions

You can use variable arguments and I/O operations with decimals.



## Using variable arguments with decimal data types

You can use the `va_arg` macro with a decimal type `decimal(n,p)`. Each invocation of `va_arg` modifies `arg_ptr` so that the values of successive arguments are returned in turn.

```
var_type va_arg( va_list arg_ptr, var_type );
```

---

## Formatting input and output operations with decimal data types

Use the `printf()` family of functions to print the value of a decimal type:

- `fprintf()`
- `printf()`
- `sprintf()`
- `vfprintf()`
- `vprintf()`
- `vsprintf()`

Use the `scanf()` family of functions to read the value of a decimal type:

- `fscanf()`
- `scanf()`
- `sscanf()`

The conversion specifier for decimal types is one of the following:

```
%D(n,p)  
%D(n)
```

For more information about these functions and their keywords, see the *z/OS XL C/C++ Runtime Library Reference*.

---

## Validating decimal values

It is possible to have nonvalid representation of decimal value stored in memory, such as input from file or overlay memory. If the nonvalid decimal value is used in an operation or assignment, the result may not be as expected. A built-in function can be used to report whether the decimal representation is valid or not. The function call can be in the following form:

```
status = decchk ( x );
```

The built-in function `decchk()` accepts a decimal-type expression as argument and returns a status value of type `int`. The status can be interpreted as follows:

- 0 Valid decimal representation value (including nonpreferred but valid sign, A-F)
- 1 Leftmost halfbyte is not zero in a decimal-type number that has an even number of digits (for example, 123 is stored in `decimal(2,0)`)
- 2 Incorrect digits (not 0-9)
- 4 Incorrect sign (not A-F)

Macro define names for function return status (in `<decimal.h>`):

```
#define DEC_VALUE_OK      0
#define DEC_BAD_NIBBLE   1
#define DEC_BAD_DIGIT    2
#define DEC_BAD_SIGN     4
```

The function return status is the OR of all errors that were detected.

See the *z/OS XL C/C++ Runtime Library Reference* for more information on the `decchk()` library function.

---

## Fixing sign variables

A built-in function can be used to fix nonpreferred sign variables. The function call can be in the following form:

```
x = decfix ( x );
```

The built-in function `decfix()` accepts a decimal-type expression as argument and returns a decimal value that has the same size (that is, same decimal types) and same value as the argument, but with the correct preferred sign. The function does not change the content of the argument. See the *z/OS XL C/C++ Runtime Library Reference* for more information on the `decfix()` library function.

---

## Returning decimal absolute values

The built-in function `decabs()` accepts a decimal-type expression as argument and returns the absolute value of the decimal argument (the same decimal type as the argument, and the same magnitude, but positive). The function does not change the content of the argument.

The function call can be in the following form:

```
y = decabs ( x );
```

See the *z/OS XL C/C++ Runtime Library Reference* for more information on the `decabs()` library function.

---

## Programming examples

Programming examples CCNGDC3 and CCNGDC4 are shipped with the compiler.

Figure 117 (CCNGDC3) shows an example of using the decimal type.

```
/*
this example demonstrates the use of the decimal type */
/* always include decimal.h when decimal type is used */

#include <decimal.h>

/* Declares a decimal(10,2) variable */
decimal(10,2) pd01;

/* Declares a decimal(15,4) variable and initializes it with the */
/* value 1234.56d */
decimal(15,4) pd02 = 1234.56d;

/* Structure that has decimal-related members */
struct pdec
{
    /* members' data types */
    int m; /* - integer */
    decimal(23,10) pd03; /* - decimal(23,10) */
    decimal(10,2) pd04[3]; /* - array of decimal(10,2) */
    decimal(10,2) *pd05; /* - pointer to decimal(10,2) */
} pd06,
    *pd07 = &pd06; /* pd07 points to pd06 */

/* Array of decimal(31,30) */
decimal(31,30) pd08[2];

/* Prototype for function that accepts decimal(10,2) and int as */
/* arguments and has return type decimal(25,5) */
decimal(25,5) product(decimal(10,2), int);

decimal(5,2) PdCnt; /* decimal loop counter */
int i;

int main(void)
{
    pd01 = -789.45d; /* simple assignment */
    pd06.m = digitsof(pd06.pd03) + precisionof(pd02); /* 23 + 4 */
    pd06.pd03 = sizeof(pd01);
    pd06.pd04[0] = pd02 + pd01; /* decimal addition */
    *(pd06.pd04 + 1) = (decimal(10,2)) product(pd07->pd04[0], pd07->m);
    pd07->pd04[2] = product(pd07->pd04[0], pd07->pd04[1]);
    pd07->pd05 = &pd01; /* taking the address of a */
    /* decimal variable */
    /* These two statements are different */
    pd08[0] = 1 / 3d;
    pd08[1] = 1d / 3d;

    printf("pd01 = %D(10,2)\n", pd01);
    printf("pd02 = %*. *D(*,*)\n",
        20, 5, digitsof(pd02), precisionof(pd02), pd02);
    printf("pd06.m = %d, pd07->m = %d\n", pd06.m, pd07->m);
    printf("pd06.pd03 = %D(23,10), pd07->pd03 = %D(23,10)\n",
        pd06.pd03, pd07->pd03);
}
```

*Decimal type — Example 1 (Part 1 of 2)*

*Figure 117. Decimal type — Example 1*

```

/* You will get an infinite loop if floating type is */
/* used instead of the decimal types. */
for (PdCnt = 0.0d; PdCnt != 3.6d; PdCnt += 1.2d)
{
    i = PdCnt / 1.2d;
    printf("pd06.pd04[%d] = %D(10,2), \
pd07->pd04[%d] = %D(10,2)\n",
        i, pd06.pd04[i], i, pd07->pd04[i]);
}

printf("*(pd06.pd05) = %D(10,2), *(pd07->pd05) = %D(10,2)\n",
    *(pd06.pd05), *(pd07->pd05));

printf("pd08[0] = %D(31,30)\n", pd08[0]);
printf("pd08[1] = %D(31,30)\n", pd08[1]);

return(0);
}

/* Function definition for product() */
decimal(25,5) product(decimal(10,2) v1, int v2)
{

    /* The following happens in the return statement */
    /* - v2 is converted to decimal(10,0) */
    /* - after the multiplication, the expression has resulting */
    /* type decimal(20,2) (i.e. (10,2) * (10,0) ==> (20,2)) */
    /* - the result is then converted implicitly to decimal(25,5) */
    /* before it is returned */
    return( v1 * v2 );
}

```

*Decimal type — Example 1 (Part 2 of 2)*

Figure 118 shows the output produced by Figure 117 on page 392.

---

```

pd01 = -789.45
pd02 =          1234.56000
pd06.m = 27, pd07->m = 27
pd06.pd03 = 6.0000000000, pd07->pd03 = 6.0000000000
pd06.pd04[0] = 445.11,          pd07->pd04[0] = 445.11
pd06.pd04[1] = 12017.97,          pd07->pd04[1] = 12017.97
pd06.pd04[2] = 5348886.87,          pd07->pd04[2] = 5348886.87
*(pd06.pd05) = -789.45, *(pd07->pd05) = -789.45
pd08[0] = 0.333333333333333333333333000000000
pd08[1] = 0.33333333333333333333333333333333

```

---

*Figure 118. Output produced by CCNGDC3*

Figure 119 on page 394 shows another sample program (CCNGDC4) that also uses decimal type.

---

```

/* this example demonstrates the use of the decimal type */

#include <decimal.h>

decimal(31,4) pd01 = 1234.5678d;
decimal(29,4) pd02 = 1234.5678d;

int main(void)
{
    /* The results are different in the next two statements */
    pd01 = pd01 + 1d;
    pd02 = pd02 + 1d;

    printf("pd01 = %D(31,4)\n", pd01);
    printf("pd02 = %D(29,4)\n", pd02);

    /* Warning: The decimal variable with size 31 should not be      */
    /*           used in arithmetic operation.                       */
    /*           In the above example: (31,4) + (1,0) ==> (31,3)    */
    /*           (29,4) + (1,0) ==> (30,4)                          */
    return(0);
}

```

---

*Figure 119. Decimal type — example 2*

Figure 120 shows the output produced by Figure 119. See “Intermediate results” on page 382 to understand the output from this example and to see why decimal variables with size 31 should be used with caution in arithmetic operations.

---

```

pd01 = 1235.5670
pd02 = 1235.5678

```

---

*Figure 120. Output produced by CCNGDC4*

---

## Decimal exception handling

z/OS XL C decimal instructions produce the following exceptions that are unique to decimal operations:

- Data exception (interrupt code hex '7')
 

This may be caused by nonvalid sign or digit codes in a packed decimal number operated on by packed decimal instructions, for example, ADD DECIMAL or COMPARE DECIMAL.

When an operation is performed on decimal operands and the assignment is not through an explicit cast operation, the following situations cause runtime exceptions at execution time and SIGFPE is raised.
- Decimal-overflow exception (interrupt code hex 'A')
 

This exception may be caused when nonzero digits are lost because the destination field in a decimal operation is too short to contain the result.

### Notes:

1. Decimal overflow conditions are supported for System Programming Calls only with the runtime library.
2. The following unhandled decimal overflow message is the same for both decimal overflow and fixed overflow conditions:
 

```
CEE3210S The system detected a Decimal-overflow exception.
```

However, because the fixed overflow condition is normally disabled (masked) and is ignored at run time, fixed overflow conditions should not occur.

- Decimal-divide exception (interrupt code hex 'B')

This exception may be caused when, in decimal division, the divisor is zero, or the quotient exceeds the specified data-field size. The decimal divide is indicated if the sign codes of both the divisor and dividend are valid, and if the digit or digits used in establishing the exception are valid.

**Note:** The following unhandled divide message does not distinguish between a decimal-divide condition and a fixed divide-by-zero condition:

CEE3211S The system detected a Decimal-divide exception.

Both are mapped into the same error message.

## printf() and scanf() and format validation

A decimal exception might be produced by the `printf()` family when processing an invalid decimal operand. This may result in abnormal termination of your program with the runtime message:

- Under z/OS:  
CEE3207S The system detected a Data exception.
- Under CICS:  
EDCK007 ABEND=8097 Data Exception

You must ensure that valid packed decimal data is present when attempting to use `printf()` or `scanf()` with runtime library decimal routines. No additional validation is performed on decimal to ensure format correctness. Use the `decchk()` routine to validate decimal data operands in such circumstances.

## Additional considerations

- When the operands of a decimal operation contain invalid digits, the result is undefined, and a runtime exception can occur. To validate a decimal number, call the `decchk()` built-in function in your code.
- Code should be written in a manner that does not depend on the ability of the runtime library to recover from a decimal overflow exception.
- In a multiprocessor configuration, decimal operations cannot be used safely to update a shared storage location when the possibility exists that another processor may also be updating that location. This possibility arises because the bytes of a decimal operand are not necessarily accessed concurrently.
- If a decimal exception occurs in user code or library routines, the expected results of the instruction causing the exception or the library routine where the exception occurred are undefined. The results produced by the library routine's execution are also undefined.
- If a SIGFPE handler is coded to handle decimal exceptions, it should reenabte itself before resuming normal execution or recovery from the error. This reestablishes the exception environment and is consistent with good programming practice.

## Error messages

If an overflow occurs at run time, the exception handler issues the following runtime error messages:

IBM482I 'ONCODE'=0310 'FIXEDOVERFLOW' CONDITION RAISED

Unhandled exception. This result may be produced in a C-only environment only for decimal overflow conditions. Fixed-point overflow exception is not allowed in the Program Mask.

**Note:** The Program Mask in the Program Status Word (PSW) is enabled for decimal overflow exceptions.

```
IBM301I  'ONCODE'=0320  'ZERODIVIDE' CONDITION RAISED
```

Unhandled decimal or fixed overflow. Fixed overflow is normally masked and ignored at C run time, but it may occur in interlanguage calls.

```
IBM537I  'ONCODE'=8097  DATA EXCEPTION
```

Unhandled data exception

The error messages for FIXEDOVERFLOW and ZERODIVIDE mean that either the fixed-point overflow condition or the decimal overflow condition has caused the condition reported.

Under CICS, decimal overflow condition exceptions are supported in CICS with C and the following runtime message is produced:

```
EDCK017 ABEND=0320 Fixed or Decimal Overflow
```

## Decimal exceptions and Assembler interlanguage calls

Calls to an assembly language procedure or function assume that the called routine will save and restore the value of the Program Mask if the routine alters it. Ensure that the Program Mask is preserved across an assembler language interface. If it is not preserved, the recognition of subsequent decimal overflow exceptions in C code will be unpredictable.

---

## Chapter 27. IEEE Floating-Point

Starting with OS/390 V2R6 (including the Language Environment and C/C++ components), support was added for IEEE binary floating-point (IEEE floating-point) as defined by the ANSI/IEEE Standard 754-1985, IEEE Standard for Binary Floating-Point Arithmetic. For more information on floating-point support, see:

- *z/Architecture Principles of Operation*
- *z/OS XL C/C++ User's Guide*
- *z/OS XL C/C++ Language Reference*
- *z/OS XL C/C++ Runtime Library Reference*
- *z/OS Language Environment Vendor Interfaces*

Starting with z/OS V1R9 (including the Language Environment and C/C++ components), support was added for IEEE decimal floating-point, as defined by the ANSI/IEEE Standard P754/D0.15.3, IEEE Standard for Floating-Point Arithmetic.

---

### Floating-point numbers

The format of floating-point numbers can be either base 16 S/390<sup>®</sup> hexadecimal format, base 2 IEEE-754 binary format, or base 10 IEEE-754 decimal format. The formats are based on three operand lengths for hexadecimal and binary: short (32 bits), long (64 bits), and extended (128 bits). The formats are also based on three operand lengths for decimal: `_Decimal32` (32 bits), `_Decimal64` (64 bits), and `_Decimal128` (128 bits).

A floating-point operand may be numeric or, for binary and decimal floating-point only, positive or negative infinity, or nonnumeric (Not a Number, or NaN). A floating-point number, has three components: a sign bit, a signed binary exponent, and a significand. The significand consists of an implicit unit digit to the left of an implied radix point, and an explicit fraction field to the right. The significand digits are based on the radix, 2 (for binary floating-point), 10 (for decimal floating-point), or 16 (for hexadecimal floating-point). The magnitude (an unsigned value) of the number is the product of the significand and the radix raised to the power of the exponent. The number is positive or negative depending on whether the sign bit is zero or one, respectively. A nonnumeric binary or decimal floating-point operand also has a sign bit, signed exponent, and fraction field.

Hexadecimal floating-point operands have formats that provide for exponents that specify powers of the radix 16 and significands that are hexadecimal numbers. The exponent range is the same for the short, long, and extended formats. The results of most operations on hexadecimal floating-point data are truncated to fit into the target format, but there are instructions available to round the result when converting to a narrower format. For hexadecimal floating-point operands, the implicit unit digit of the significand is always zero. Because the value if the significand and fraction are the same, hexadecimal floating-point operations are described in terms of the fraction, and the term significand is not used.

Binary floating-point operands have formats which provide for exponents that specify powers of the radix 2 and significands that are binary numbers. The



exponent range differs for different formats, the range being greater for the longer formats. In the long and extended formats, the exponent range is significantly greater for binary floating-point data than for hexadecimal floating-point data. The results of operations performed on binary floating-point data are rounded automatically to fit into the target format; the manner of rounding is determined by a program-settable rounding mode.

Decimal floating-point operands have formats that provide for exponents that specify powers of the radix 10 and significands that are decimal numbers. The exponent range differs for different formats, the range being greater for the longer formats. The results of operations performed on decimal floating-point data are rounded automatically to fit into the target format; the manner of rounding is determined by a program-settable rounding mode.

---

## C/C++ compiler support

The C/C++ compiler provides a `FLOAT` option to select the format of floating-point numbers produced in a compile unit. The `FLOAT` option allows you to select either IEEE binary floating-point or hexadecimal floating-point format. For details on the z/OS XL C/C++ support, see the description of the `FLOAT` option in *z/OS XL C/C++ User's Guide*. In addition, two related sub-options, `ARCH(3)` and `TUNE(3)`, support IEEE binary floating-point data. Refer to the `ARCHITECTURE` and `TUNE` compiler options in *z/OS XL C/C++ User's Guide* for details.

The *z/OS XL C/C++ Language Reference* contains additional information on floating-point in the following sections:

- Floating Point Literals
- Floating-Point Variables
- Floating-Point Conversions
- Floating-Point Standards

### Notes:

1. You must have OS/390 Release 6 or higher to use the IEEE binary floating-point instructions. In Release 6, the base control program (BCP) is enhanced to support the new IEEE binary floating-point hardware in the IBM S/390 Generation 5 Server. This enables programs running on OS/390 Release 6 to use the IEEE binary floating-point instructions and 16 floating-point registers. In addition, the BCP provides simulation support for all the new floating-point hardware instructions. This enables applications that make light use of IEEE binary floating-point, and can tolerate the overhead of software simulation, to execute on OS/390 V2R6 without requiring an IBM S/390 Generation 5 Server.
2. The terms binary floating-point and IEEE binary floating-point are used interchangeably. The abbreviations BFP and HFP, which are used in some function names, refer to binary floating-point and hexadecimal floating-point respectively.
3. Under hexadecimal floating-point format, the rounding mode is set to round toward 0. Under IEEE binary floating-point format, the rounding mode is set to round toward the nearest integer.

---

## Using IEEE floating-point

IEEE binary floating-point is provided primarily to enhance interoperability and portability between IBM System z and other platforms. It is anticipated that IEEE binary floating-point will be most commonly used for new and ported applications. Customers should not migrate existing applications that use hexadecimal floating-point to IEEE binary floating-point, unless there is a specific reason.

IBM does not suggest mixing Binary and Hexadecimal floating-point formats in an application. However, for applications which must handle both formats, the C/C++ runtime library does offer some support. Reference information for IEEE binary floating-point can also be found in *z/OS XL C/C++ Language Reference*.

You should use IEEE binary floating-point in the following situations:

- You deal with data that are already in IEEE binary floating-point format
- You need the increased exponent range (see *z/OS XL C/C++ Language Reference* for information on exponent ranges with IEEE-754 floating-point)
- You want the changes in programming paradigm provided by infinities and NaN (Not a Number)

For more information about the IEEE format, refer to the IEEE 754-1985 IEEE Standard for Binary Floating-Point Arithmetic.

When you use IEEE binary floating-point, make sure that you are in the same rounding mode at compile time (specified by the `ROUND(mode)` option), as at run time. Entire compilation units will be compiled with the same rounding mode throughout the compilation. If you switch runtime rounding modes inside a function, your results may vary depending upon the optimization level used and other characteristics of your code; switch rounding mode inside functions with caution.

If you have existing data in hexadecimal floating-point (the original base 16 S/390 hexadecimal floating-point format), and have no need to communicate these data to platforms that do not support this format, there is no reason for you to change to IEEE binary floating-point format.

Applications that mix the two formats are not supported.

IEEE binary and decimal floating-point are fully supported in a CICS environment only if CICS TS Version 4 or later is in use.

For information on the C/C++ functions that support floating-point, see the functions listed in Table 81. For more information, see *z/OS XL C/C++ Runtime Library Reference*.

*Table 81. C/C++ functions that support floating-point*

<code>absf()</code>	<code>absl()</code>	<code>acos()</code>	<code>acosd32()</code>
<code>acosd64()</code>	<code>acosd128()</code>	<code>acosf()</code>	<code>acosh()</code>
<code>acoshd32()</code>	<code>acoshd64()</code>	<code>acoshd128()</code>	<code>acoshf()</code>
<code>acoshl()</code>	<code>acosl()</code>	<code>asin()</code>	<code>asind32()</code>
<code>asind64()</code>	<code>asind128()</code>	<code>asinf()</code>	<code>asinh()</code>
<code>asinhd32()</code>	<code>asinhd64()</code>	<code>asinhd128()</code>	<code>asinhf()</code>
<code>asinhl()</code>	<code>asinl()</code>	<code>atan()</code>	<code>atand32()</code>
<code>atand64()</code>	<code>atand128()</code>	<code>atanf()</code>	<code>atanh()</code>
<code>atanhd32()</code>	<code>atanhd64()</code>	<code>atanhd128()</code>	<code>atanhf()</code>

Table 81. C/C++ functions that support floating-point (continued)

atanhl()	atanl()	__atanpid32()	__atanpid64()
__atanpid128()	atan2()	atan2d32()	atan2d64()
atan2d128()	atan2f()	atan2l()	cabs()
cabsf()	cabsl()	acos()	cacosf()
cacosh()	cacoshf()	cacoshl()	cacosl()
carg()	cargf()	cargl()	casin()
casinf()	casinh()	casinhf()	casinhl()
casinl()	catan()	catanf()	catanh()
catanhf()	catanhl()	catanl()	cbrt()
cbrtd32()	cbrtd64()	cbrtd128()	cbrtf()
cbrtl()	ccos()	ccosf()	ccosh()
ccoshf()	ccoshl()	ccosl()	ceil()
ceild32()	ceild64()	ceild128()	ceilf()
ceill()	cexp()	cexpf()	cexpl()
cimag()	cimagf()	cimagl()	clog()
clogf()	clogl()	conj()	conjf()
conjl()	copysign()	copysignd32()	copysignd64()
copysignd128()	copysignf()	copysignl()	cos()
cosd32()	cosd64()	cosd128()	cosf()
cosh()	coshd32()	coshd64()	coshd128()
coshf()	coshl()	cosl()	__cospid32()
__cospid64()	__cospid128()	cotan()	cotanf()
cotanl()	cpow()	cpowf()	cpowl()
cproj()	cprojf()	cprojl()	creal()
crealf()	creall()	csin()	csinf()
csinh()	csinhf()	csinhl()	csinl()
csqrt()	csqrtf()	csqrtl()	ctan()
ctanf()	ctanh()	ctanhf()	ctanhl()
ctanl()	erf()	erfc()	erfcd32()
erfcd64()	erfcd128()	erfcf()	erfcl()
erfd32()	erfd64()	erfd128()	erff()
erfl()	exp()	expf()	expl()
expm1()	expm1d32()	expm1d64()	expm1d128()
expm1f()	expm1l()	exp2()	exp2d32()
exp2d64()	exp2d128()	exp2f()	exp2l()
expd32()	expd64()	expd128()	fabs()
fabsd32()	fabsd64()	fabsd128()	fabsf()
fabsl()	fdim()	fdimd32()	fdimd64()
fdimd128()	fdimf()	fdiml()	feclearexcept()
fe_dec_getround()	fe_dec_setround()	fegetenv()	fegetexceptflag()
fegetround()	feholdexcept()	feraiseexcept()	fesetenv()
fesetexceptflag()	fesetround()	fetestexcept()	feupdateenv()
finite()	floor()	flood32()	flood64()
flood128()	floorf()	floorl()	fma
fmad32()	fmad64()	fmad128()	fmaf()
fmal()	fmax()	fmaxd32()	fmaxd64()
fmaxd128()	fmaxf()	fmaxl()	fmin()
fmind32()	fmind64()	fmind128()	fminf()
fminl()	fmod()	fmodd32()	fmodd64()
fmodd128()	fmodf()	fmodl()	fpclassify()
fp_read_rnd()	fp_swap_rnd()	frexp()	frexpd32()
frexpd64()	frexpd128()	frexpf()	frexpl()
gamma()	gamma_r()	hypot()	hypotd32()
hypotd64()	hypotd128()	hypotf()	hypotl()
ilogb()	ilogbd32()	ilogbd64()	ilogbd128()

Table 81. C/C++ functions that support floating-point (continued)

ilogbf()	ilogbl()	isfinite()	isgreater()
isgreaterequal()	isinf()	isless()	islessequal()
islessgreater()	isnan()	isnormal()	isunordered()
jn()	j0()	j1()	ldexp()
ldexpd32()	ldexpd64()	ldexpd128()	ldexpf()
ldexpl()	lgamma()	lgammad32()	lgammad64()
lgammad128()	lgammaf()	lgammal()	gamma_r()
llrint()	llrintd32()	llrintd64()	llrintd128()
llrintf()	llrintl()	llround()	llroundd32()
llroundd64()	llroundd128()	llroundf()	llroundl()
log()	logb()	logbd32()	logbd64()
logbd128()	logbf()	logbl()	logf()
logl()	log10()	log10d32()	log10d64()
log10d128()	log10f()	log10l()	log1p()
log1pd32()	log1pd64()	log1pd128()	log1pf()
log1pl()	log2()	log2d32()	log2d64()
log2d128()	log2f()	log2l()	logd32()
logd64()	logd128()	lrint()	lrintd32()
lrintd64()	lrintd128()	lrintf()	lrintl()
lround()	lroundd32()	lroundd64()	lroundd128()
lroundf()	lroundl()	matherr()	modf()
modff()	modfl()	modfd32()	modfd64()
modfd128()	nan()	nand32()	nand64()
nand128()	nanf()	nanl()	nearbyint()
nearbyintd32()	nearbyintd64()	nearbyintd128()	nearbyintf()
nearbyintl()	nextafter()	nextafterd32()	nextafterd64()
nextafterd128()	nextafterf()	nextafterl()	nexttoward()
nexttowardd32()	nexttowardd64()	nexttowardd128()	nexttowardf()
nexttowardl()	pow()	powd32()	powd64()
powd128()	powf()	powl()	quantexpd32()
quantexpd64()	quantexpd128()	quantized32()	quantized64()
quantized128()	remainder()	remainderd32()	remainderd64()
remainderd128()	remainderf()	remainderl()	remquo( )
__remquod32()	__remquod64()	__remquod128()	remquoof( )
remquoof( )	rint()	rintd32()	rintd64()
rintd128()	rintf()	rintl()	round()
roundd32()	roundd64()	roundd128()	roundf()
roundl()	samequantumd32()	samequantumd64()	samequantumd128()
scalb()	scalbln()	scalblnd32()	scalblnd64()
scalblnd128()	scalblnf()	scalblnl()	scalbn()
scalbnd32()	scalbnd64()	scalbnd128()	scalbnf()
scalbnl()	signbit()	significand()	sin()
sind32()	sind64()	sind128()	sinf()
sinh()	sinhd32()	sinhd64()	sinhd128()
sinhf()	sinhl()	sinl()	__sinpid32()
__sinpid64()	__sinpid128()	sqrt()	sqrtd32()
sqrtd64()	sqrtd128()	sqrtf()	sqrtl()
tan()	tand32()	tand64()	tand128()
tanf()	tanhd32()	tanhd64()	tanhd128()
tanl()	tanh()	tanhf()	tanhl()
tgamma()	tgammad32()	tgammad64()	tgammad128()
tgammaf()	tgammal()	trunc()	truncd32()
truncd64()	truncd128()	truncf()	truncf()
yn()	y0()	y1()	

In *z/OS Language Environment Vendor Interfaces*, the chapter on C/C++ Special Purpose Interfaces for IEEE Floating-Point provides information on the following functions.

*Table 82. Special purpose C/C++ functions that support floating-point*

<code>__chkbfp()</code>	<code>__fp_btoh()</code>	<code>__fp_cast()</code>	<code>__fp_htob()</code>
<code>__fp_level()</code>	<code>__fp_read_rnd()</code>	<code>__fp_setmode()</code>	<code>__fp_swapmod()</code>
<code>__fp_swap_rnd()</code>	<code>__fpc_rd()</code>	<code>__fpc_rs()</code>	<code>__fpc_rw()</code>
<code>__fpc_sm()</code>	<code>__fpc_wr()</code>	<code>__isBFP()</code>	

---

## Chapter 28. Handling error conditions, exceptions, and signals

This chapter discusses how to handle error conditions, exceptions, and signals with z/OS XL C/C++. It describes how to establish, enable and raise a signal, and provides a list of signals supported by z/OS XL C/C++.

In 31-bit applications, there are two basic ways to handle program checks and ABENDs:

- POSIX or ANSI signals (SIGABND, SIGFPE, SIGILL, SIGSEGV)
- User condition handlers registered using CEEHDLR interface or the USRHDLR runtime option.

In 31-bit applications, z/OS Language Environment uses a stack-based model to handle error conditions. This environment establishes a last-in, first-out (LIFO) queue of 0 or more user condition handlers for each stack frame. The z/OS Language Environment condition handler calls the user condition handler at each stack frame to handle error conditions when they are detected. For more information about the callable services in z/OS Language Environment, refer to “Handling signals using Language Environment callable services” on page 409.

In AMODE 64 applications, user condition handlers are not available. The basic ways to handle program checks and ABENDs in AMODE 64 applications are:

- POSIX or ANSI signals (SIGABND, SIGFPE, SIGILL, SIGSEGV)
- Exception handlers registered using the `__set_exception_handler()` C runtime library function. See “AMODE 64 exception handlers” on page 407 for more information.

The C error handling approach using signals is supported in a z/OS XL C/C++ program, but there are some restrictions (refer to “Handling C software exceptions under C++” on page 404). See “Signal handlers” on page 408 for more information.

C++ exception handling is supported in all z/OS environments that are supported by C++ (including CICS and IMS); you must run your application with the TRAP(ON) runtime option. To turn off C++ exception handling, use the compiler option NOEXH. For more information on this compiler option, see *z/OS XL C/C++ User's Guide*.

**Note:** If C++ exception handling is turned off you will get code which runs faster but is not ANSI conformant.

This chapter also describes some aspects of C++ object-oriented exception handling. The object-oriented approach uses the try, throw, and catch mechanism. Refer to *z/OS XL C/C++ Language Reference* for a complete description. Some library functions (`abort()`, `atexit()`, `exit()`, `setjmp()` and `longjmp()`) are affected by C++ exception handling; refer to *z/OS XL C/C++ Runtime Library Reference* for more information.

---

## Handling C software exceptions under C++

Using the C and C++ condition handling schemes together in a C++ program may result in undefined behavior. This applies to the use of `try`, `throw` and `catch` with `signal()` and `raise()`, with z/OS Language Environment condition handlers such as CEEHDLR, or with CICS HANDLE ABEND under CICS in 31-bit mode. The behavior with respect to running destructors for automatic objects is undefined, due to control being transferred to non-C++ exception handlers (such as signal handlers) and stacks being collapsed. If a C software exception is not handled and results in program termination, the behavior for destructors for static non-local objects will also be undefined.

With z/OS UNIX, in a multithreaded environment, z/OS XL C++ exception stacks are managed on a per-thread basis. This means an exception thrown on one thread cannot be caught on another thread, including the IPT where `main()` was started. If the exception is not handled by the thread from which it was thrown, then the `terminate()` function is called.

---

## Handling hardware exceptions under C++

You cannot use `try`, `throw`, and `catch` to handle hardware exceptions.

If a hardware exception resulting in abnormal termination occurs in a z/OS XL C++ program, destructors for static and automatic objects are not run. If a hardware exception occurs, and a handler was registered for the exception using `signal()`, the behavior of destructors for automatic objects is undefined.

---

## Tracebacks under C++

A traceback is not produced if a thrown object was caught and handled.

If an object is thrown, and no catch clauses exist that will handle the thrown object, the program will call `terminate()`. By default, `terminate()` calls `abort()`, and the traceback produced will show that this has occurred. The traceback will not show the point from which the object was originally thrown. Instead, it will show that the object was thrown from the last encountered catch clause.

In sample routine CCNGCH1 (Figure 121 on page 405), `sub1()` throws object `a`. Because `sub1()` does not have any catch clauses to handle `a`, C++ attempts to find a suitable catch clause in the calling sub function, and then in the `main` function. Because no catch clauses can be found to handle object `a`, the traceback will show that object `a` was thrown from `main()`.

---

```

/* example of C++ exception handling */

#include <iostream.h>
#include <stdlib.h>

class A {
    int i;
public:
    A(int j) { i = j; cout << "A ctor: i= " << i << '\n'; }
    A() { cout << "A dtor: i= " << i << '\n'; }
};
class B {
    char c;
public:
    B(char d) { c = d; cout << "B ctor: c= " << c << '\n'; }
    B() { cout << "B dtor: c= " << c << '\n'; }
};
void sub(void);
void subl(void);

main() {
    try {
        sub();
    }
    //traceback will show that the thrown object was from here because
    //no catch clauses match the thrown object and the last rethrow
    //occurred here.
    catch(int i) { cout << "caught an integer" << '\n'; }
    catch(char c) { cout << "caught a character" << '\n'; }
    exit(55);
}

void sub() {
    try {
        subl();
    }
    //neither catch clause will catch object a, so again a will be
    //rethrown
    catch(double d) { cout << "caught a double" << '\n'; }
    catch(float f) { cout << "caught a float" << '\n'; }
    return;
}

void subl() {
    A a(3001);
    try {
        throw(a);
    }
    //neither catch clause will catch object a, so a will be rethrown
    catch(B b) { cout << "caught a B object" << '\n'; }
    catch(short s) { cout << "caught a short" << '\n'; }
    return;
}

```

---

Figure 121. Example illustrating C++ exception handling/traceback

If an object is thrown and a catch clause catches but then rethrows that object, or throws another object, and no catch clauses exist for the rethrown or subsequently thrown object, the traceback starts at the point from which the rethrow or subsequent throw occurred. The first object thrown is considered to have been caught and handled.

In sample routine CCNGCH2 (Figure 122 on page 406), the traceback would show that the `testeh` function rethrows an integer. Because there is no catch clause to handle the rethrown integer, the traceback will also show that `terminate()` and then `abort()` were called.



---

```

/* example of C++ exception handling */

#include <iostream.h>
#include <stdlib.h>

int testeh(void);
class A {
    int i;
    public:
        A(int j) { i = j; cout << "A ctor: i= " << i << '\n'; }
        A() { cout << "A dtor: i= " << i << '\n'; }
};
class B {
    char c;
    public:
        B(char d) { c = d; cout << "B ctor: c= " << c << '\n'; }
        B() { cout << "B dtor: c= " << c << '\n'; }
};
A staticA(333);
B staticB('z');
void sub();

main() {
    sub();
    return(55);
}

void sub()
{
    A c(3001);
    try {
        cout << "calling testeh" << '\n';
        testeh(); // int will be rethrown from testeh()
    }
    // no catch clauses for the rethrown int
    catch(char c) { cout << "caught char" << '\n'; }
    catch(short s) { cout << "caught short s = " << s << '\n'; }
    cout << "this line should not be printed" << '\n';
    return;
}
testeh()
{
    A a(2001),a1(1001);
    B b('k');
    short k=12;
    int j=0,l=0;

    try {
        cout << "testeh running" << '\n';
        throw (6); // first throw: an int
    }
    catch(char c) { cout << "testeh caught char" << '\n';}
    catch(int j) { cout << "testeh caught int j = " << j << '\n';
        try { // int should be caught here
            cout << "testeh again rethrowing" << '\n';
            throw; // rethrow the int
        }
        catch(char d) { cout << "char d caught" << '\n'; }
    }
    cout << "this line should not be printed" << '\n';
    return(0);
}

```

---

Figure 122. Example illustrating C++ exception handling/traceback

---

## AMODE 64 exception handlers

In AMODE 64 applications, exception handlers are registered using the `__set_exception_handler()` C runtime library function. When no exception handler is registered, program checks and ABENDs cause POSIX/ANSI signals to be raised. These signals can be caught by user-written signal catchers, where suitable recovery can be done. When an exception handler is registered, no signal is generated when a program check or ABEND occurs. Instead, the active exception handler is invoked. Since program checks and ABENDs do not generate signals, the blocked/unblocked/ignored/caught settings for SIGABND, SIGFPE, SIGILL, and SIGSEGV make no difference. When an exception handler is active, all non-program-check and non-ABEND signal processing still occurs as described by POSIX or ANSI. Only signals normally generated by program checks or ABENDs are suppressed.

### Scope and nesting of exception handlers

Exception handlers apply only to the thread they are registered on. In a multi-threaded application, it is possible to have a mixture of threads, some with exception handlers registered, and some without. Program checks and ABENDs occurring on threads without active exception handlers cause the usual ANSI/POSIX signal generation. Program checks and ABENDs occurring on threads with active exception handlers will bypass signal generation and will cause the active exception handler to be invoked.

Exception handlers are also stack-frame based, much like 31-bit user condition handlers. If function `a()` registers an exception handler, future program checks and ABENDs will drive that handler, until the handler is de-registered. This includes program checks occurring in `a()` (after the registration), and in any called functions. Function `a()` can deregister the handler using `__reset_exception_handler()`. After this is done, program checks and ABENDs once again cause signals to be raised. If function `a()` returns without calling `__reset_exception_handler()` to deregister its handler, the handler will be automatically removed when `a()` returns.

If function `a()` registers handler `ah()`, and calls function `b()`, program checks and ABENDs in `b()` will also go to `ah()`. However, `b()` can register its own handler, `bh()`, in which case any program checks and ABENDs in `b()` or any functions it calls will go to `bh()`. Exception handlers can be nested in this way as deep as required. If they are not explicitly deregistered by calling `__reset_exception_handler()`, they are automatically removed when the registering function returns. They are also removed, whenever a longjump-type function (`longjmp()`, `_longjmp()`, `siglongjmp()`, `setcontext()`, or C++ `throw`) causes control to jump back past the function that registered the handler. (Example: `a()` registers handler `ah()`, and calls `b()`, which registers handler `bh()`, and calls `c()`. Function `c()` longjumps back into `a()`. In this case, `bh()` will be removed, but `ah()` will remain.)

**Note:** Whenever a program check or ABEND occurs, no more than one exception handler will ever be driven, even when several nested handlers have been registered. The active handler is the one that was most recently registered, and not de-registered/removed. It will usually be the handler registered by the most deeply-nested routine at the time of the program check or ABEND.

During C++ throw processing, as the Language Environment stack is unwound and destructors for automatic C++ object are invoked, handlers registered by more-deeply nested functions are temporarily bypassed, in case program checks or ABENDs occur in the destructors. Example: `a()` registers handler `ah()`, and calls `b()`.

Function b() has a dynamic object with destructor bd(). Function b() calls c(), which has a dynamic object with destructor cd(), and it registers handler ch(). Function c() then calls d(), which registers handler dh(), and then throws a C++ exception that will eventually get caught back in a(). As the C++ destructors are run, program checks/ABENDs in cd() go to handler ch(), and program checks/ABENDs in bd() go to ah(). By the time control resumes in the catch clause in a(), dh() and ch() are gone, and ah() is the active exception handler. This same type of exception handler scoping occurs after pthread\_exit() is called and all outstanding C++ dynamic destructors still left on the stack are run.

If a program does pthread\_exit() while an exception handler is active, that exception handler remains active while any pthread\_keycreate() destructor routines and any pthread\_cleanup\_push() routines are invoked. These routines can register their own exception handlers, too, if required.

When atexit() routines or C++ static destructors are run, any active exception handlers at the time of the exit() or pthread\_exit() have already been removed. If these routines need recovery, they can register their own exception handlers.

## Handling exceptions

When the active exception handler is called after a program check or ABEND, it receives a pointer to the CIB (Condition Information Block) for the error. It can examine the CIB and associated MCH (Machine Check Handler record) to determine what the error is. The handler can fix up whatever is required or take dumps, etc. When it is finished, the only valid things it can do are:

- Long jump back to some earlier pre-defined recovery point (any of the several longjump-type functions may be used -- longjmp(), \_longjmp(), siglongjmp(), setcontext(), or C++ throw.)
- Issue exit() or \_exit()
- Issue pthread\_exit()
- Issue \_\_cabend(), abort(), etc

What it cannot do is return. If it returns, the system will automatically do pthread\_exit(-1) if POSIX(ON) is in effect, or exit(-1) if not.

When the active exception handler is given control, the handler is suspended, along with all other handlers already registered. This means that any future program checks/ABENDs will cause the usual signal processing to occur. The active handler is re-enabled once it longjumps back. If it exits or returns, it is not re-activated, and termination starts with no active exception handler. If an exception handler needs exception handling recovery for its own program checks or ABENDs, it must register its own exception handler. As usual, this new handler will become active, and will get control for any program checks/ABENDs occurring in the outer exception handler or any routines it calls.

---

## Signal handlers

The basis for error handling in z/OS UNIX XL C/C++ application programs is the generation, delivery, and handling of signals. Signals can be generated and delivered as a result of system events or application programming. You can code your application program to generate and send signals and to handle and respond to signals delivered to it.

Two types of signal handling are supported for catching signals: ANSI C and POSIX.1. Each of these has standard signal delivery rules, which are discussed in

this chapter. Asynchronous signal delivery under z/OS UNIX is also discussed. For additional information on the subject of POSIX-conforming signals, see *The POSIX.1 Standard: A Programmer's Guide*, by Fred Zlotnick, (Redwood City, CA: The Benjamin/Cummings Publishing Company, Inc., 1991).

## Handling signals with POSIX(OFF) using signal() and raise()

The z/OS XL C environment provides two functions that alter the signal handling capabilities available in the runtime environment: `signal()` and `raise()`. The `signal()` function registers a condition handler and the `raise()` function raises the condition.

In general, for C++ programs you are encouraged to use `try`, `throw`, and `catch` to perform exception handling. However, you can also use the z/OS XL C `signal()` and `raise()` functions.

You can use the `signal()` function to perform one of the following actions:

- Ignore the condition. For example, use the `SIG_IGN` condition to specify `signal(SIGFPE, SIG_IGN)`.
- Reset the Global Error Table for default handling. For example, use the `SIG_DFL` condition to specify `signal(SIGSEGV, SIG_DFL)`.
- Register a function to handle the specific condition. For example, pass a pointer to a function for the specific condition with `signal(SIGILL, cfunc1)`. The function registered for `signal()` must be declared with C linkage.

## Handling signals using Language Environment callable services

In 31-bit mode, you can set up user signal handlers with the z/OS Language Environment condition handling services. Some of the z/OS Language Environment callable services available for condition handling are:

### CEEHDLR

Register a user-written condition handler.

### CEEHDLU

Remove a registered user-written condition handler.

### CEESGL

Raise z/OS Language Environment condition.

In addition, with z/OS Language Environment, when an exception occurs after an interlanguage call, the exception may be handled where it occurs, or percolated to its caller (written in any z/OS Language Environment-conforming language), or promoted. For more information on how to handle exceptions under the z/OS Language Environment condition handling model, refer to *z/OS Language Environment Programming Guide*.

### Specific considerations for C and C++ under z/OS Language Environment:

1. The TRAP runtime option (equivalent to the former C/370 runtime options SPIE and STAE) determines how the z/OS Language Environment condition manager is to act upon error conditions and program interrupts. If the TRAP(OFF) runtime option is in effect, conditions detected by the operating system, often due to machine interrupts, will not be handled by the z/OS Language Environment environment and thus cannot be handled by a z/OS XL C/C++ program.

**Note:** TRAP(OFF) only blocks the handling of hardware (program checks) and operating system (abend) conditions. It does not block software conditions such as those that are associated with a raise or CEESGL (31-bit mode). Any conditions that are blocked because of TRAP(OFF) are not presented to any handlers (whether registered by a signal or by CEEHDLR). In particular, even for TRAP(OFF), conditions that are initiated by a signal or by CEESGL (31-bit mode) are presented to handlers registered by either signal() or CEEHDLR.

The use of the TRAP(OFF) option is not recommended; refer to *z/OS Language Environment Programming Reference* for more information.

2. You can use the ERRRCOUNT runtime option to specify how many errors are to be tolerated during the execution of your program before an abend occurs. The counter is incremented by one for every severity 2, 3, or 4 condition that occurs. Both hardware-generated and software-generated signals increment the counter.

If your C++ program uses try, throw, and catch, it is recommended that you specify either ERRRCOUNT(0) (31-bit mode), which allows an unlimited number of errors, or ERRRCOUNT(n) (31-bit mode), where n is a fairly high number. This is because z/OS XL C++ generates a severity 3 condition for each thrown object. In addition, each catch clause has the potential to rethrow an object or to throw a new object. In a large C++ program, many conditions can be generated as a result of objects being thrown, and thus the ERRRCOUNT can be exceeded if the value used for it is too low. The default used for ERRRCOUNT is usually a low number.

**Note:** The z/OS XL C/C++ registered condition handlers (those registered by signal() and raise()), are activated after the z/OS Language Environment registered condition handlers for the current stack frame are activated. This means that if there are condition handlers for both z/OS XL C/C++ and z/OS Language Environment, the z/OS Language Environment handlers are activated first.

Combining C++ condition handling (using try, throw, and catch), with z/OS Language Environment condition handling may result in undefined behavior.

## Handling signals using z/OS UNIX with POSIX(ON)

z/OS UNIX signal processing allows flags to control the behavior of signal processing. Using these flags, you can simulate these signals and a wide variety of other signals such as ANSI, POSIX.1, and BSD.

ANSI C has the following standard signal delivery rules:

- Traditionally, signal actions are established only through the signal().
- During signal delivery, the signal action is reset to SIG\_DFL before the user signal action catcher function receives control.
- During signal delivery to a user signal catcher function, the signal mask is not changed.

POSIX.1 has the following standard signal delivery rules:

- Signal actions are typically established through the sigaction() function. With the addition of XPG4 support, there are a number of new flags that have been defined for sigaction() that extend its flexibility.
- During signal delivery, the signal action is not changed.
- During signal delivery to a user signal catcher function, the signal mask is changed to the *union* of:
  - The signal mask at the time of the interruption

- A signal mask that blocks the signal type being delivered  
The signal mask is restored when the signal catcher function returns.

BSD signals for the most part are consistent with the POSIX rules above except for the following:

- BSD signal mask is a 31-bit mask whereas the z/OS UNIX signal mask is a AMODE 64 mask. The relationship of the bits to specific signals is not the same. Therefore, we recommend you change to use the sigset manipulation functions, such as, sigadd(), sigdelete(), sigempty().
- Traditionally, for BSD to generate a signal action, the signal() function was used. However, because the signal() function is used in ANSI, BSD applications should be changed to use the bsd\_signal() function.
- During signal delivery, the signal action is not changed.
- During signal delivery to a user signal catcher function, the signal mask is changed to the union of:
  - The signal mask at the time of the interruption
  - The signal mask specified in the sa\_mask field of the sigaction() function
 The signal mask is restored once the signal catcher function returns.

For compatibility, z/OS XL C/C++ supports the three standards listed above, and additional functions provided by XPG4.

Under z/OS XL C/C++, the primary function for establishing signal action is the sigaction() function. However, there are a number of other functions that you can use to effect signal processing. All signal types are accessible regardless of the function used to establish the signal action.

Table 83 includes functions that will establish a signal handler for a signal action.

*Table 83. Functions that establish a signal handler*

<b>BSD Function</b>	<b>Purpose</b>
bsd_signal()	BSD version of signal()
sigaction()	Examine and/or change a signal action
sigignore()	Set disposition to ignore a signal
sigset()	Change a signal action and/or a thread's signal mask
signal()	Specify signal handling

Table 84 lists other signal-related functions.

*Table 84. Other signal-related functions*

<b>Signal Related Functions</b>	<b>Purpose</b>
abort()	Stop a program
kill()	Send a signal to a process
pthread_kill()	Send a signal to a thread
raise()	Send a signal to yourself
sigaddset()	Add a signal to a signal set
sigdelset()	Delete a signal from a signal set
sigemptyset()	Initialize a signal set to exclude all signals
sigfillset()	Initialize a signal set to include all signals

Table 84. Other signal-related functions (continued)

Signal Related Functions	Purpose
sighold()	Add a signal to a thread's signal mask
siginterrupt()	Allow signals to interrupt functions
sigismember()	Test if a signal is in a signal set
sigpause()	Unblock a signal and wait for a signal
sigprocmask()	Examine and/or change a thread's signal mask
sigqueue()	Queue a signal to a process
sigrelse()	Remove a signal from a thread's signal mask
sigstack()	Set and/or get signal stack context
sigaltstack()	Set and/or get signal alternate stack context
sigsuspend()	Change mask and suspend the thread
sigwait()	Wait for asynchronous signal
sigpending()	Examine pending signals
sigtimedwait()	Wait for queued signals
sigwaitinfo()	Wait for queued signals

## Asynchronous signal delivery under z/OS UNIX

Your z/OS UNIX application program might require its active processes to be able to react and respond to events occurring in the system or resulting from the actions of other processes communicating with its processes. One way of accomplishing such interprocess communication is for you to code your application program to identify signal conditions and determine how to react or respond when a signal condition is received from another application process.

Before you attempt to code your z/OS UNIX C/C++ application program to deliver and handle signals, you should identify all the processes that might cause signal conditions to be received by your application program's processes. You also need to know which signal condition codes are valid for your z/OS UNIX C/C++ application program and where the `signal.h` header file will be located and available to your application program. Your system programmer or the application program's designer should provide this information.

**Note:** Signal condition codes are defined in the `signal.h` include file.

A *signal* is a mechanism by which a process can be notified of, or affected by, an event occurring in the system. Examples of such events include hardware exceptions and specific actions by processes. The term *signal* also refers to an event itself.

The POSIX.1-defined `sigaction()` function allows a calling application process to examine a specific signal condition and specify the processing action to be associated with it.

You can code your application program to use the `sigaction()` function in different ways. Two simplistic examples of using signals within z/OS UNIX C/C++ application programs follow:

1. A process is forked but the process is *aborted* if the signal handler receives an incorrect value.



2. A request is received from a *client* process to provide information from a database. The *server* process is a single point of access to the database.

If coded properly for handling and delivering interprocess signals, your application program can receive signals from other processes and interpret those signals such that the appropriate processing procedure occurs for each specific signal condition received. Your application program also can send signals and wait for responses to signal handling events from other application processes. Note that signals are not the best method of interprocess communication, because they can easily be lost if more than one is delivered at the same time. You may want to use other methods of interprocess communication, such as pipes, message queues, shared memory, or semaphores.

For descriptions of the supported z/OS XL C/C++ signal handling functions, see *z/OS XL C/C++ Runtime Library Reference*.

**Note:** If your z/OS UNIX C/C++ application program calls a program written in a high-level language other than z/OS UNIX C/C++, you need to disable signal handling to block all signals from the z/OS UNIX C/C++ application program. If the called program encounters a program interrupt check situation, the results are unpredictable.

## C signal handling features under z/OS XL C/C++

The terms used to describe implementation features and concepts are:

- Establishing a signal handler
- Enabling a signal
- Interrupting a program
- Raising a signal

### Establishing a signal handler

A signal handler for a signal, `sig_num`, becomes established when `signal(sig_num, sig_handler)` is executed. (Two values of `sig_handler` are reserved: `SIG_IGN` and `SIG_DFL`. They are special values that establish the action taken.) `sig_handler` is a pointer to a function to be called when the signal is raised. This function is also known as a *signal handler*. Under C++, the signal handler function must have C linkage, by declaring it as `extern "C"`. Under C, the function must be written in C with the default linkage in effect. That is, `sig_handler` cannot have OS, PLI, C++, or COBOL linkage. The signal handler for the signal ceases to be established when:

- The signal is explicitly reset to the system default by using `signal(sig_num, SIG_DFL)`.
- You indicate that a signal is to be ignored by using `signal(sig_num, SIG_IGN)`.
- The signal is implicitly reset to the system default when the signal is raised. When `sig_handler` is called, signal handling is reset to the default as if an implicit `signal(sig_num, SIG_DFL)` had been executed. Depending on the purpose of the signal handler, you may want to reestablish the signal from within the signal handler.
- Under C, a loaded executable is deleted using the `release()` function and a signal handler for the signal resides in the executable. In this case, default handling will be reset for all the affected signals.
- A DLL module is explicitly loaded using `dllload()`, a function pointer in that module is obtained using `dllqueryfn()`, a signal handler is establishing using that function, and the DLL module is then explicitly deleted using `dllfree()`. Default handling will be reset for the affected signal.



**Note:** A C signal handler can be written in C, or can be written in C++ and declared as extern "C" so that it has C linkage.

### **Enabling a signal**

A signal is enabled when the occurrence of the condition will result in either the execution of an established signal handler or the default system response. The signal is disabled when the occurrence is to be ignored, such as, when the signal action is SIG\_IGN. This can be done by making the call `signal(sig_num, SIG_IGN)`. Using z/OS UNIX with POSIX(ON), SIG\_IGN may be set with several other functions, such as, `sigaction()`. In addition to changing the signal action to SIG\_IGN, the signal can be enabled or disabled (blocked) using the `sigprocmask()` function.

### **Interrupting a program**

Program interrupts or errors detected by the hardware and identified to the program by operating system mechanisms are known as hardware signals. For example, the hardware can detect a divide by zero and this result can be raised to the program.

### **Raising a signal**

Signals that are explicitly raised by the user, by using the `raise()` function or using z/OS UNIX with POSIX(ON) using the `kill()`, `killpg()`, or `pthread_kill()` functions, are known as software signals.

### **Identifying hardware and software signals**

The following signals are a list of signals supported with z/OS XL C/C++ under POSIX(OFF):

#### **SIGABND**

System abend.

#### **SIGABRT**

Abnormal termination (software only).

#### **SIGFPE**

Erroneous arithmetic operation (hardware and software).

#### **SIGILL**

Invalid object module (hardware and software).

#### **SIGINT**

Interactive attention interrupt by `raise()` (software only).

#### **SIGIOERR**

Serious software error such as a system read or write. You can assign a signal handler to determine the file in which the error occurs or whether the condition is an abort or abend. This minimizes the time required to locate the source of a serious error.

#### **SIGSEGV**

Invalid access to memory (hardware and software).

#### **SIGTERM**

Termination request sent to program (software only).

#### **SIGUSR1**

Reserved for user (software only).

#### **SIGUSR2**

Reserved for user (software only).

The following signals are a list of signals supported with z/OS XL C/C++ under POSIX(ON):

**SIGABND**

System abend.

**SIGABRT**

Abnormal termination (software only).

**SIGALRM**

Asynchronous timeout signal generated as a result of an alarm().

**SIGBUS**

Bus error.

**SIGCHLD**

Child process terminated or stopped.

**SIGCLD**

Child process terminated or stopped.

**SIGCONT**

Continue execution, if stopped.

**SIGDANGER**

Shutdown imminent.

**SIGDUMP**

Take a SYSMDUMP.

**SIGFPE**

Erroneous arithmetic operation (hardware and software).

**SIGHUP**

Hangup, when a controlling terminal is suspended or the controlling process ended.

**SIGILL**

Invalid object module (hardware and software).

**SIGINT**

Asynchronous CNTL-C from one of the z/OS UNIX shells or a software generated signal.

**SIGIO**

Completion of input or output.

**SIGIOERR**

Serious software error such as a system read or write. Assign a signal handler to determine the file in which the error occurs or whether the condition is an abort or abend. Minimize the time required to locate the source of a system error.

**SIGKILL**

An unconditional terminating signal.

**SIGPIPE**

Write on a pipe with no one to read it.

**SIGPOLL**

Pollable event.

**SIGPROF**

Profiling timer expired.

<b>SIGQUIT</b>	Terminal quit signal.
<b>SIGSEGV</b>	Invalid access to memory (hardware and software).
<b>SIGSTOP</b>	The process is stopped.
<b>SIGSYS</b>	Bad system call.
<b>SIGTERM</b>	Termination request sent to program (software only).
<b>SIGTHCONT</b>	The specific thread is resumed.
<b>SIGTHSTOP</b>	The specific thread is stopped.
<b>SIGTRACE</b>	UNIX System Services syscall trace toggle signal.
<b>SIGTRAP</b>	Debugger event.
<b>SIGTSTP</b>	Terminal stop signal.
<b>SIGTTIN</b>	Background process attempting read.
<b>SIGTTOU</b>	Background process attempting write.
<b>SIGURG</b>	High bandwidth is available at a socket.
<b>SIGUSR1</b>	Reserved for user (software only).
<b>SIGUSR2</b>	Reserved for user (software only).
<b>SIGVTALRM</b>	Virtual timer expired.
<b>SIGWINCH</b>	Window size has changed.
<b>SIGXCPU</b>	CPU time limit exceeded.
<b>SIGXFSZ</b>	File size limit exceeded.

The applicable hardware signals or exceptions are listed in Table 85 on page 417. It also lists those hardware exceptions that are not supported (for example, fixed-point overflow) and are masked.

The applicable software signals or exceptions that are supported with POSIX(OFF) are listed in Table 86 on page 417 (see Table 87 on page 419 for the POSIX(ON) signals).

Table 85. Hardware exceptions - Default runtime messages and system actions

C Signal	Hardware Exception	Default Runtime Message with z/OS Language Environment	Default System Action with z/OS Language Environment Library
SIGILL	Operation exception	CEE3201	Abnormal termination MVS rc=3000
	Privileged operation exception	CEE3202	
	Execute exception	CEE3203	
SIGSEGV	Protection exception	CEE3204	Abnormal termination MVS rc=3000
	Addressing exception	CEE3205	
	Specification exception	CEE3206	
SIGFPE	Data exception	CEE3207	Abnormal termination MVS rc=3000
	Fixed-point divide	CEE3209	
	Decimal overflow (for C only)	CEE3210	
	Decimal divide	CEE3211	
	Exponent overflow	CEE3212	
	Floating point divide	CEE3215	
	Compare and Trap Data Exception	CEE3234	

**Note:** Under TSO, SIGINT will not be raised if you press the attention key. It must be raised using raise().

The default runtime program mask is enabled for decimal overflow exceptions.

Table 86 shows software signals with POSIX(OFF) or exceptions, their origin, default runtime messages and default system actions.

Table 86. Software exceptions - Default runtime messages and system actions with POSIX(OFF)

C Signal	Software Exception	Default Runtime Message with z/OS Language Environment	Default System Action with z/OS Language Environment Library
SIGFPE	raise(SIGFPE)	EDC6000	Abnormal Termination MVS rc=3000
SIGILL	raise(SIGILL)	EDC6001	Abnormal Termination MVS rc=3000
SIGSEGV	raise(SIGSEGV)	EDC6002	Abnormal Termination MVS rc=3000
SIGFPE	raise(SIGFPE)	EDC6002	Abnormal Termination MVS rc=3000
SIGABND	raise(SIGABND)	EDC6003	Abnormal Termination MVS rc=3000
SIGTERM	raise(SIGTERM)	EDC6004	Abnormal Termination MVS rc=3000
SIGINT	raise(SIGINT)	EDC6005	Abnormal Termination MVS rc=3000

Table 86. Software exceptions - Default runtime messages and system actions with POSIX(OFF) (continued)

C Signal	Software Exception	Default Runtime Message with z/OS Language Environment	Default System Action with z/OS Language Environment Library
SIGABRT	raise(SIGABRT)	EDC6006	Abnormal Termination MVS rc=2000
SIGUSR1	raise(SIGUSR1)	EDC6007	Abnormal Termination MVS rc=3000
SIGUSR2	raise(SIGUSR2)	EDC6008	Abnormal Termination MVS rc=3000
SIGIOERR	raise(SIGIOERR)	EDC6009	Signal is ignored

### SIGABND considerations

When the SIGABND signal is registered with an address of a C handler using the `signal()` function, control cannot resume at the instruction following the `abend` or the invocation of `raise()` with SIGABND. If the C signal handler is returned, the `abend` is percolated and the default behavior occurs. The `longjmp()` or `exit()` function can be invoked from the handler to control the behavior.

If SIG\_IGN is the specified action for SIGABND and an `abend` occurs (or SIGABND was raised), the `abend` will not be ignored because a resume cannot occur. The `abend` will percolate and the default action will occur.

Two macros are available in `signal.h` header file that provide information about an `abend`. The `__abendcode()` macro returns the `abend` that occurred and `__rsncode()` returns the corresponding reason code for the `abend`. These values are available in a C signal handler that has been registered with the SIGABND signal. If you are looking for the `abend` and reason codes, using these macros, they should only be checked when in a signal handler. The values returned by the `__abendcode()` and `__rsncode()` macros are undefined if the macros are used outside a registered signal handler.

### SIGIOERR considerations

When the SIGIOERR signal is raised, codes for the last operation will be set in the `__amrc` structure to aid you in error diagnosis.

### Default handling of signals

The runtime environment performs default handling of a given signal unless the signal is established (`signal(sig_num, sig_handler)`) or the signal is disabled (`signal(sig_num, SIG_IGN)`). A user can set or reset default handling by coding `signal(sig_num, SIG_DFL)`.

The default handling depends upon the signal that was raised. For more information about the default handling of a given signal, see Table 85 on page 417, Table 86 on page 417, and Table 87 on page 419.

**Using z/OS UNIX:** Table 87 on page 419 describes the default actions for signals that may be delivered to C/C++ application programs running POSIX(ON).

Table 87. Default signal processing with POSIX(ON)

Signal	Default Action
<b>SIGABND</b>	Clean up the z/OS XL C/C++ runtime library, issue message CEE5204, and end the process. The signal exit status is returned to the parent process if it is waiting for a child process to end. If the program is not running in a forked process, so that no parent process exists to return the signal status to, the return code 3000 is returned to the system. If the signal is generated as a result of an abend condition, as opposed to being software generated by a <code>raise()</code> , <code>kill()</code> , or <code>pthread_kill()</code> function, the CEE5204 message is issued along with a trace-back message indicating a user function was in control when the abend occurred.
<b>SIGABRT</b>	Clean up the z/OS XL C/C++ runtime library, issue message CEE5207 and end the process. The signal exit status is returned to the parent process if it is waiting for a child process to end. If the program is not running in a forked process, so that no parent process exists to return the signal status to, the return code 3000 is returned to the system.
<b>SIGALRM</b>	Clean up the z/OS XL C/C++ runtime library, issue message CEE5214 and end the process. The signal exit status is returned to the parent process if it is waiting for a child process to end. If the program is not running in a forked process, so that no parent process exists to return the signal status to, the return code 3000 is returned to the system.
<b>SIGCHLD</b>	The signal is ignored.
<b>SIGCLD</b>	The signal is ignored.
<b>SIGCONT</b>	The process is continued if it was stopped. Otherwise, the signal is ignored.
<b>SIGDANGER</b>	The signal is ignored.
<b>SIGDUMP</b>	The system will obtain a user address space dump.
<b>SIGFPE</b>	Clean up the z/OS XL C/C++ runtime library, issue message CEE5201, and end the process. The signal exit status is returned to the parent process if it is waiting for a child process to end. If the program is not running in a forked process, so that no parent process exists to return the signal status to, the return code 3000 is returned to the system. If the signal is generated as a result of an abend condition, as opposed to being software generated by a <code>raise()</code> , <code>kill()</code> , or <code>pthread_kill()</code> function, the CEE5201 message is issued along with a trace-back message indicating a user function was in control when the abend occurred.
<b>SIGHUP</b>	Clean up the z/OS XL C/C++ runtime library, issue message CEE5210 and end the process. The signal exit status is returned to the parent process if it is waiting for a child process to end. If the program is not running in a forked process, so that no parent process exists to return the signal status to, the return code 3000 is returned to the system.
<b>SIGILL</b>	Clean up the z/OS XL C/C++ runtime library, issue message CEE5202, and end the process. The signal exit status is returned to the parent process if it is waiting for a child process to end. If the program is not running in a forked process, so that no parent process exists to return the signal status to, the return code 3000 is returned to the system. If the signal is generated as a result of an abend condition, as opposed to being software generated by a <code>raise()</code> , <code>kill()</code> , or <code>pthread_kill()</code> function, the CEE5202 message is issued along with a trace-back message indicating a user function was in control when the abend occurred.
<b>SIGINT</b>	Clean up the z/OS XL C/C++ runtime library, issue message CEE5206 and end the process. The signal exit status is returned to the parent process if it is waiting for a child process to end. If the program is not running in a forked process, so that no parent process exists to return the signal status to, the return code 3000 is returned to the system.
<b>SIGIO</b>	The signal is ignored.
<b>SIGIOERR</b>	The signal is ignored. In a POSIX application running on z/OS UNIX SIGIOERR is not supported directly by the kernel. Instead, z/OS XL C/C++ maps SIGIOERR to SIGIO. Any application using SIGIOERR should not also use SIGIO.
<b>SIGKILL</b>	End the process with no z/OS XL C/C++ runtime cleanup.
<b>SIGPIPE</b>	Clean up the z/OS XL C/C++ runtime library, issue message CEE5213 and end the process. The signal exit status is returned to the parent process if it is waiting for a child process to end. If the program is not running in a forked process, so that no parent process exists to return the signal status to, the return code 3000 is returned to the system.

Table 87. Default signal processing with POSIX(ON) (continued)

Signal	Default Action
<b>SIGQUIT</b>	Clean up the z/OS XL C/C++ runtime library, issue message CEE5220 and end the process. The signal exit status is returned to the parent process if it is waiting for a child process to end. If the program is not running in a forked process, so that no parent process exists to return the signal status to, the return code 3000 is returned to the system.
<b>SIGSEGV</b>	Clean up the z/OS XL C/C++ runtime library, issue message CEE5203 and end the process. The signal exit status is returned to the parent process if it is waiting for a child process to end. If the program is not running in a forked process, so that no parent process exists to return the signal status to, the return code 3000 is returned to the system.
<b>SIGSTOP</b>	The process is stopped.
<b>SIGTERM</b>	Clean up the z/OS XL C/C++ runtime library, issue message CEE5205 and end the process. The signal exit status is returned to the parent process if it is waiting for a child process to end. If the program is not running in a forked process, so that no parent process exists to return the signal status to, the return code 3000 is returned to the system.
<b>SIGTHCONT</b>	The specific thread is resumed.
<b>SIGTHSTOP</b>	The specific thread is stopped.
<b>SIGTRACE</b>	The UNIX System Services syscall trace is toggled.
<b>SIGTRAP</b>	Clean up the z/OS XL C/C++ runtime library, issue message CEE5222 and end the process. The signal exit status is returned to the parent process if it is waiting for a child process to end. If the program is not running in a forked process, so that no parent process exists to return the signal status to, the return code 3000 is returned to the system.
<b>SIGTSTP</b>	The process is stopped.
<b>SIGTTIN</b>	The process is stopped.
<b>SIGTTOU</b>	The process is stopped.
<b>SIGUSR1</b>	Clean up the z/OS XL C/C++ runtime library, issue message CEE5208 and end the process. The signal exit status is returned to the parent process if it is waiting for a child process to end. If the program is not running in a forked process, so that no parent process exists to return the signal status to, the return code 3000 is returned to the system. In past releases, the default action for this signal was to ignore the signal.
<b>SIGUSR2</b>	Clean up the z/OS XL C/C++ runtime library, issue message CEE5209 and end the process. The signal exit status is returned to the parent process if it is waiting for a child process to end. If the program is not running in a forked process, so that no parent process exists to return the signal status to, the return code 3000 is returned to the system. In past releases, the default action for this signal was to ignore the signal.
<b>SIGPOLL</b>	Clean up the z/OS XL C/C++ runtime library, issue message CEE5225 and end the process. The signal exit status is returned to the parent process if it is waiting for a child process to end. If the program is not running in a forked process, so that no parent process exists to return the signal status to, the return code 3000 is returned to the system.
<b>SIGURG</b>	The signal is ignored.
<b>SIGBUS</b>	Clean up the z/OS XL C/C++ runtime library, issue message CEE5227 and end the process. The signal exit status is returned to the parent process if it is waiting for a child process to end. If the program is not running in a forked process, so that no parent process exists to return the signal status to, the return code 3000 is returned to the system.
<b>SIGSYS</b>	Clean up the z/OS XL C/C++ runtime library, issue message CEE5228 and end the process. The signal exit status is returned to the parent process if it is waiting for a child process to end. If the program is not running in a forked process, so that no parent process exists to return the signal status to, the return code 3000 is returned to the system.
<b>SIGWINCH</b>	The signal is ignored.

Table 87. Default signal processing with POSIX(ON) (continued)

Signal	Default Action
<b>SIGXCPU</b>	Clean up the z/OS XL C/C++ runtime library, issue message CEE5230 and end the process. The signal exit status is returned to the parent process if it is waiting for a child process to end. If the program is not running in a forked process, so that no parent process exists to return the signal status to, the return code 3000 is returned to the system.
<b>SIGXFSZ</b>	Clean up the z/OS XL C/C++ runtime library, issue message CEE5231 and end the process. The signal exit status is returned to the parent process if it is waiting for a child process to end. If the program is not running in a forked process, so that no parent process exists to return the signal status to, the return code 3000 is returned to the system.
<b>SIGVTALRM</b>	Clean up the z/OS XL C/C++ runtime library, issue message CEE5232 and end the process. The signal exit status is returned to the parent process if it is waiting for a child process to end. If the program is not running in a forked process, so that no parent process exists to return the signal status to, the return code 3000 is returned to the system.
<b>SIGPROF</b>	Clean up the z/OS XL C/C++ runtime library, issue message CEE5233 and end the process. The signal exit status is returned to the parent process if it is waiting for a child process to end. If the program is not running in a forked process, so that no parent process exists to return the signal status to, the return code 3000 is returned to the system.
<b>Dubbed Process:</b>	A process that is not from a call to a fork() function or to a program main() function through an exec() function.

*Summary of C error handling:*

**Procedure**

1. Signal is raised. Is SIG\_IGN set for the signal? Or is the signal blocked?

Option	Description
Yes	See 2
No	See 5

2. Is the signal for a SIGABND?

Option	Description
Yes	See 3
No	See 4

3.
  - a. Condition is percolated for default behavior.
4.
  - a. Resume at the next instruction.
5.
  - a. Continue at 6.
6. Is the signal asynchronous (or previously blocked)?

Option	Description
Yes	See 7
No	See 12 on page 422

7. Is a C handler established for the signal?



Option	Description
Yes	See 8
No	See 11

8. Was the C handler established by `signal()` or `sigaction()` with the `SA_OLD_STYLE` or `SA_RESETHAND` flag set?

Option	Description
Yes	See 9
No	See 10

- 9.
- a. Run C handler using ANSI rules and transfer control to the next instruction following asynchronous interrupt.

- 10.
- a. Run C handler using POSIX rules and transfer control to the next instruction following the asynchronous interrupt.

- 11.
- a. Perform default processing.

12. Is z/OS Language Environment user handler registered?

Option	Description
Yes	See 13
No	See 14

- 13.
- a. Run z/OS Language Environment user handler. The handler can resume, percolate or promote the signal. See *z/OS Language Environment Programming Guide* for more details.

14. Is a C handler established for the signal by `signal()` or `sigaction()` with the `SA_OLD_STYLE` or `SA_RESETHAND` flag set?

Option	Description
Yes	See 15
No	See 16

- 15.
- a. Run C handler using ANSI rules and resume at the next instruction.

- 16.
- a. Continue at 17.

17. At stack frame 0?

Option	Description
Yes	See 18
No	See 21 on page 423

18. Was a C handler established?

Option	Description
Yes	See 19
No	See 20

19.

- a. Run C handler using POSIX signal delivery rules and resume at next instruction.

20.

- a. Perform default processing.

21.

- a. Default handling for the signal and percolate to next stack frame.

**Signal considerations using z/OS UNIX:** The following restrictions and inconsistencies exist for z/OS UNIX XL C/C++ application program signal handling:

- Signal processing is blocked by the kernel when an application program is running on a request block (RB) other than the one the `main()` routine was started on.
- An application program should not use the `longjmp()` function to exit from a signal catcher established through the use of `sigaction()`. The `sigsetjmp()` and `siglongjmp()` functions should be used instead of `setjmp()` and `longjmp()`. The `longjmp()` function can be used if the `signal()` function was used to establish the signal catcher.
- An application program must not use the macro versions of the `getc()`, `putc()`, `getchar()`, and `putchar()` functions to perform I/O to the same file from an asynchronous signal catcher function.
- Floating point registers are saved before a call to the signal catcher function and restored when the signal catcher returns. This is done for all signals.
- For z/OS UNIX XL C/C++ application programs, the `errno` value is saved before a call to the signal catcher function and restored when the signal catcher returns.

### **Example of C signal handling under z/OS XL C or z/OS XL C++**

In example program CCNGEC1 (Figure 123 on page 424), the call to `signal()` in `main()` establishes the function signal handler to process the interrupt signal when it occurs. An error value returned from this call to `signal()` causes the program to end with a printed error message. The signal handler function asks you to enter a `y` or `Y` from the keyboard if you want to halt the program. Entering any other character causes the program to resume operation.

---

```

/* this example demonstrates signal handling */

#include <stdio.h>
#include <signal.h>
#include <stdlib.h>

#ifdef __cplusplus /* __cplusplus is implicitly defined when */
    extern "C" { /* the program is compiled with the z/OS C++ */
#endif /* compiler */

void handler(int);

#ifdef __cplusplus
}
#endif

int main(void) {
    if (signal(SIGINT,handler) == SIG_ERR) {
        perror("Could not set SIGINT");
        abort();
    }
    /* add code here if desired */
    raise(SIGINT);
    /* add code here if desired */
    return(0);
}

void handler(int sig_num) {
    char ch;

    signal(SIGINT, handler);
    printf("End processing?\n");
    ch = getchar();
    if (ch == 'y' || ch == 'Y')
        exit(0);
}

```

---

*Figure 123. Example illustrating signal handling*

---

## Chapter 29. Network communications under UNIX System Services

This chapter discusses interprocess communication, including MVS Sockets for z/OS UNIX and the X/Open Transport Interface (XTI) for z/OS UNIX and the internetworking involved.

Many products today supply a socket interface. The types of application programming interfaces (APIs) for the sockets which will be covered in this chapter are:

- **X/Open Socket**
- **Berkeley Socket**

If you are running with some other socket API, this material will not necessarily apply.

Your z/OS UNIX XL C/C++ application program can take advantage of sockets or XTI to communicate with a related application (server or client).

The X/Open Transport Interface (XTI) defines an independent transport service interface that allows multiple users to communicate at the transport level of the OSI reference model. More information can be found at the end of this chapter.

---

### Understanding z/OS UNIX sockets and internetworking

z/OS UNIX provides support for an enhanced version of an industry-accepted protocol for client/server communication known as *sockets*. The three types of application programming interfaces(API), for the sockets which will be covered in this chapter are:

- **X/Open Socket:** The API type of socket as defined by X/Open in XPG4.2.
- **Berkeley Socket:** The socket API that represents a migration path for programs coded under the HOT1120 and HOT1130 elements. It allows use of the BSD4.3 interface and function in the X/Open environment. Its purpose is to expedite the porting of existing BSD4.3 applications.

The z/OS UNIX socket API provides support for both UNIX domain sockets and Internet domain sockets. UNIX domain sockets, or *local sockets*, allow interprocess communication within MVS independent of TCP/IP. Local sockets behave like traditional UNIX-domain sockets and allow processes to communicate with one another on a single system. Internet sockets allow application programs to communicate with others in the network using TCP/IP.

This chapter provides some background information about z/OS UNIX sockets and about network communication in general. It is intended to provide an overview of the programming concepts associated with using z/OS UNIX sockets and network communication.

For information about using the socket API, see *z/OS XL C/C++ Runtime Library Reference*.

---

## Basics of network communication

This section looks at network communication from a very high level and defines some terms used throughout the book. For more detailed information on z/OS network communication and TCP/IP sockets, see *z/OS Communications Server: IP Configuration Guide* and *z/OS Communications Server: IP Programmer's Guide and Reference*. For more detailed information on IPv6 network communication and AF\_INET6 sockets, see *z/OS Communications Server: IPv6 Network and Appl Design Guide*.

Network communication, or *internetworking*, defines a set of protocols (that is, rules and standards) that allow application programs to talk with each other without regard to the hardware and operating systems where they are run. Internetworking allows application programs to communicate independently of their physical network connections.

The internetworking technology called *TCP/IP* is named after its two main protocols: Transmission Control Protocol (TCP) and Internet Protocol (IP). To understand TCP/IP, you should be familiar with the following terms:

**client** A process that requests services on the network.

**server** A process that responds to a request for service from a client.

**datagram**

The basic unit of information, consisting of one or more data packets, which are passed across an Internet at the transport level.

**packet** The unit or block of a data transaction between a computer and its network. A packet usually contains a network header, at least one high-level protocol header, and data blocks. Generally, the format of data blocks does not affect how packets are handled. Packets are the exchange medium used at the Internetwork layer to send data through the network.

## Transport protocols for sockets

A *protocol* is a set of rules or standards that each host must follow to allow other hosts to receive and interpret messages sent to them. There are two general types of transport protocols:

- A *connectionless protocol* is a protocol that treats each datagram as independent from all others. Each datagram must contain all the information required for its delivery.

An example of such a protocol is *User Datagram Protocol (UDP)*. UDP is a datagram-level protocol built directly on the IP layer and used for application-to-application programs on a TCP/IP host. UDP does not guarantee data delivery, and is therefore considered unreliable. Application programs that require reliable delivery of streams of data should use TCP.

- A *connection-oriented protocol* requires that hosts establish a logical connection with each other before communication can take place. This connection is sometimes called a *virtual circuit*, although the actual data flow uses a packet-switching network. A connection-oriented exchange includes three phases:

1. Start the connection
2. Transfer data
3. End the connection

An example of such a protocol is *Transmission Control Protocol (TCP)*. TCP provides a reliable vehicle for delivering packets between hosts on an Internet.

TCP breaks a stream of data into datagrams, sends each one individually using IP, and reassembles the datagrams at the destination node. If any datagrams are lost or damaged during transmission, TCP detects this and retransmits the missing datagrams. The data stream that is received is therefore a reliable copy of the original.

These types of protocols are illustrated in Figure 125 on page 436 and in Figure 126 on page 437.

## What is a socket?

A *socket* can be thought of as an endpoint in a two-way communication channel. Socket routines create the communication channel, and the channel is used to send data between application programs either locally or over networks. Each socket within the network has a unique name associated with it called a *socket descriptor*—a fullword integer that designates a socket and allows application programs to refer to it when needed.

Using an electrical analogy, you can think of the communication channel as the electrical wire with its plug and think of the port, or socket, as the electrical socket or outlet, as shown in Figure 124.

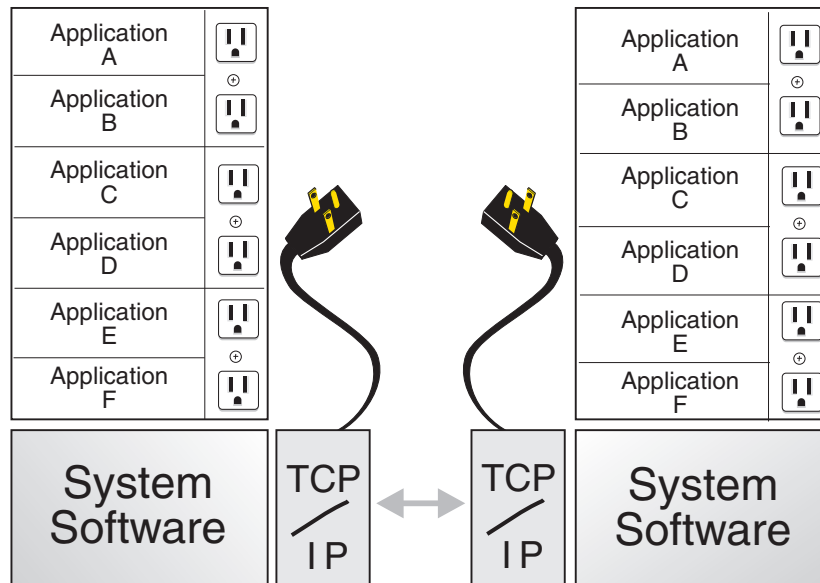

Figure 124. An electrical analogy showing the socket concept

This figure shows many application programs running on a client and many application programs on a server. When the client starts a socket call, a socket connection is made between an application on the client and an application on the server.

Another analogy used to describe socket communication is a telephone conversation. Dialing a phone number from your telephone is similar to starting a socket call. The telephone switching unit knows where to logically make the correct switch to complete the call at the remote location. During your telephone conversation, this connection is present and information is exchanged. After you hang up, the connection is broken and you must start it again. The client uses the `socket()` function call to start the logical switch mechanism to connect to the server.

As with file access, user processes ask the operating system to create a socket when one is needed. The system returns an integer, the socket descriptor (*sd*), that the application uses every time it wants to refer to that socket. The main difference between sockets and files is that the operating system binds file descriptors to a file or device when the `open()` call creates the file descriptor. With sockets, application programs can choose to either specify the destination each time they use the socket—for example, when sending datagrams—or to bind the destination address to the socket.

Sockets behave in some respects like UNIX files or devices, so they can be used with such traditional operations as `read()` or `write()`. For example, after two application programs create sockets and open a connection between them, one program can use `write()` to send a stream of data, and the other can use `read()` to receive it. Because each file or socket has a unique descriptor, the system knows exactly where to send and to receive the data.

You can wait on a socket using the following asynchronous I/O functions:

- `aioread()` - Asynchronous read from a socket
- `aiowrite()` - Asynchronous write to a socket
- `aio_cancel()` - Cancel an asynchronous I/O request
- `aio_suspend()` - Wait for an asynchronous I/O request
- `aio_error()` - Retrieve error status for an asynchronous I/O operation
- `aio_return()` - Retrieve return status for an asynchronous I/O operation

You can suspend the invoking thread until a specified asynchronous I/O event, timeout, or signal occurs. These functions are described in *z/OS XL C/C++ Runtime Library Reference*.

## z/OS UNIX Socket families

In z/OS UNIX, the following socket families are supported:

- UNIX Domain Sockets, known as *local sockets*, which are part of the UNIX Address Family (`AF_UNIX`)
- Internet Protocol Sockets, which are part of the Internet Address Family (`AF_INET` for IPv4 and `AF_INET6` for IPv6)

`AF_UNIX` sockets provide communication between processes on a single system. This socket family supports two types of sockets—stream and datagram sockets. These socket types are described in the next section.

`AF_INET` and `AF_INET6` sockets provide a means of communicating between application programs that are on different systems using the Transport Control Protocol provided by a TCP/IP product. This socket family supports both stream and datagram sockets. Each of these socket types is described in the next section.

## z/OS UNIX Socket types

The z/OS UNIX socket API provides application programs with a network interface that hides the details of the physical network. The socket API supports both *stream sockets* and *datagram sockets*, each providing different services for application programs. Stream and datagram sockets interface to the transport layer protocols, UDP and TCP. You choose the appropriate interface for an application.

### Stream sockets

*Stream sockets* act like streams of information. There are no boundaries between data, so communicating processes must agree on their own mechanism to

distinguish information. Usually, the process sending information sends the length of the data, followed by the data itself. The process receiving information reads the length and then loops, accepting data until all of it has been transferred. Stream sockets guarantee delivery of the data in the order it was sent and without duplication. The stream socket interface defines a reliable connection-oriented service. Data is sent without errors or duplication and is received in the same order as it is sent. Flow control is built in, to avoid data overruns. No boundaries are imposed on the data; the data is considered to be a stream of bytes.

Stream sockets are more common, because the burden of transferring the data reliably is handled by the system rather than by the application.

### **Datagram sockets**

The *datagram socket* interface defines a connectionless service. Datagrams are sent as independent packets. The service provides no guarantees; data can be lost or duplicated, and datagrams can arrive out of order. The size of a datagram is limited to the size that can be sent in a single transaction. No disassembly and reassembly of packets is performed.

## **Guidelines for using socket types**

This section describes criteria to help you choose the appropriate socket type for an application program.

If you are communicating with an existing application program, you must use the same protocols as the existing application program. For example, if you communicate with an application that uses TCP, you must use stream sockets. For other application programs, you should consider the following factors:

- **Reliability.** Stream sockets provide the most reliable connection. Datagram sockets are unreliable, because packets can be discarded, corrupted, or duplicated during transmission. This may be acceptable if the application program does not require reliability, or if the application program implements the reliability on top of the sockets interface. The trade-off is the increased performance available with datagram sockets.
- **Performance.** The overhead associated with reliability, flow control, packet reassembly, and connection maintenance degrade the performance of stream sockets in comparison with datagram sockets.
- **Data transfer.** Datagram sockets impose a limit on the amount of data transferred in a single transaction. If you send less than 2048 bytes at a time, use datagram sockets. As the amount of data in a single transaction increases, use stream sockets.

## **Addressing within sockets**

The following sections describe the different ways to address within the socket API.

### **Address families**

Address families define different styles of addressing. All hosts in the same address family use the same scheme for addressing socket endpoints. z/OS UNIX supports three address families—AF\_INET, AF\_INET6, and AF\_UNIX. The AF\_INET and AF\_INET6 address families define addressing in the IP domain. The AF\_UNIX address family defines addressing in the z/OS UNIX domain. In the z/OS UNIX domain, address spaces can use the socket interface to communicate with other address spaces on the same host.



**Note:** In this case, the z/OS UNIX domain is used in much the same way as the UNIX domain on other UNIX-type systems.

## Socket address

A socket address is defined by the *sockaddr* structure in the *sys/socket.h* include file. The structure has three fields, as shown in the following example:

```
struct sockaddr {
    unsigned char sa_len;
    unsigned char sa_family;
    char          sa_data[14]; /* variable length data */
};
```

The *sa\_len* field contains the length of the *sa\_data* field. The *sa\_family* field contains the address family. It is *AF\_INET* or *AF\_INET6* for the Internet domain and *AF\_UNIX* for the UNIX domain. The *sa\_data* field is different for each address family. Each address family defines its own structure, which can be overlaid on the *sockaddr* structure. See “Addressing within the *AF\_INET* domain” on page 431 and “Addressing within the *AF\_INET6* domain” on page 431 for more information about the Internet domain, and “Addressing within the *AF\_UNIX* domain” on page 432 for more information about the UNIX domain.

## Internet addresses

Internet addresses represent a network interface. Every Internet address within an administered *AF\_INET* domain must be unique. On the other hand, it is not necessary that every host have a unique Internet address; in fact, a host has as many Internet addresses as it has network interfaces.

## Ports

A port is used to distinguish between different application programs using the same network interface. It is an additional qualifier used by the system software to get data to the correct application program. Physically, a port is a 16-bit integer. Some ports are reserved for particular application programs or protocols and are called *well-known ports*.

## Network byte order

Ports and addresses are usually specified to calls using the network byte ordering convention. This convention is a method of sorting bytes under specific machine architectures. There are two common methods:

- *Big-endian* byte ordering places the most significant byte first. This method is used in IBM mainframe processors.
- *Little-endian* byte ordering places the least significant byte first. This method is used in Intel microprocessors.

Using network byte ordering for data exchanged between hosts allows hosts using different architectures to exchange address information. See references in figures Figure 128 on page 438, Figure 129 on page 439, and Figure 131 on page 440 for examples of using the *htons()* call to put ports into network byte order. For more information about network byte order, see *z/OS XL C/C++ Runtime Library Reference*.

**Note:** The socket interface does not handle application program data byte ordering differences. Application program writers must handle byte order differences themselves.

## Addressing within the AF\_INET domain

A socket address in the Internet address family comprises the following fields: the address family (AF\_INET), an Internet address, the length of that Internet address, a port, and a character array. The structure of the Internet socket address is defined by the following `sockaddr_in` structure, which is found in the `netinet/in.h` include file:

```
struct in_addr {
    ip_addr_t s_addr;

    struct sockaddr_in {
        unsigned char sin_len;
        unsigned char sin_family;
        unsigned short sin_port;
        struct in_addr sin_addr;
        unsigned char sin_zero[8];
    };
};
```

*sin\_len* set to the length of the *sockaddr\_in* structure

*sin\_family*  
set to AF\_INET

*sin\_port*  
port used by the application program, in network byte order

*sin\_zero*  
field should be set to all zeros

## Addressing within the AF\_INET6 domain

A socket address in the Internet address family comprises the following fields: the address family (AF\_INET6), an Internet address, the length of that Internet address, a port, flow information, and scope information. The structure of the Internet socket address is defined by the following `sockaddr_in6` structure, which is found in the `netinet/in.h` include file:

```
struct in6_addr {
    union {
        uint8_t _S6_u8[16];
        uint32_t _S6_u32[4];
    } _S6_un;
};
#define s6_addr _S6_un._S6_u8

struct sockaddr_in6 {
    uint8_t sin6_len;
    sa_family_t sin6_family;
    in_port_t sin6_port;
    uint32_t sin6_flowinfo;
    struct in6_addr sin6_addr;
    uint32_t sin6_scope_id;
};
```

*sin6\_len*  
Set to the length of the *sockaddr\_in6* structure

*sin6\_family*  
Set to AF\_INET

*sin6\_port*  
Port used by the application program, in network byte order

*sin6\_flowinfo*

32-bit field that contains the traffic class and the flow label

*sin6\_addr*

a single *in6\_addr* structure, which holds one 128-bit IPv6 address stored in network byte order

*sin6\_scope\_id*

a 32 bit integer that identifies a set of interfaces as appropriate for the scope of the address carried in the *sin6\_addr* field.

**Note:** IPv6 structures are exposed by defining the `_OPEN_SYS_SOCKET_IPV6` feature test macro.

### Addressing within the AF\_UNIX domain

A socket address in the AF\_UNIX address family is comprised of three fields: the length of the following pathname, the address family (AF\_UNIX), and the pathname itself. The structure of an AF\_UNIX socket address is defined as follows:

```
struct sockaddr_un {
    unsigned char  sun_len;
    unsigned char  sun_family;
    char  sun_path[108];    /* pathname */
};
```

This structure is defined in the `sockaddr_un` structure found in `sys/un.h` include file. The *sun\_len* contains the length of the pathname in *sun\_path*; *sun\_family* field is set to `AF_UNIX`; and *sun\_path* contains the null-terminated pathname.

---

## The conversation

The client and server exchange data using a number of functions. They can send data using `send()`, `sendto()`, `sendmsg()`, `write()`, or `writv()`. They can receive data using `recv()`, `recvfrom()`, `recvmsg()`, `read()`, or `readv()`. The following is an example of the `send()` and `recv()` call:

```
send(s, addr_of_data, len_of_data, 0);
recv(s, addr_of_buffer, len_of_buffer, 0);
```

The `send()` and `recv()` function calls specify the sockets on which to communicate, the address in memory of the buffer that contains, or will contain, the data (*addr\_of\_data*, *addr\_of\_buffer*), the size of this buffer (*len\_of\_data*, *len\_of\_buffer*), and a flag that tells how the data is to be sent. Using the flag `0` tells TCP/IP to transfer the data normally. The server uses the socket that is returned from the `accept()` call.

These functions return the amount of data that was either sent or received. Because stream sockets send and receive information in streams of data, it can take more than one call to `send()` or `recv()` to transfer all the data. It is up to the client and server to agree on some mechanism of signaling that all the data has been transferred.

When the conversation is over, both the client and server call the `close()` function to end the connection. The `close()` function also deallocates the socket, freeing its space in the table of connections. To end a connection with a specific client, the server closes the socket returned by `accept()`. If the server closes its original

socket, it can no longer accept new connections, but it can still converse with the clients it is connected to. The following is an example of the `close()` call:

```
close(s);
```

## The server perspective

Before the server can accept any connections with clients, it must register itself with TCP/IP and “listen” for client requests on a specific port.

### Allocation with `socket()`

The server must first allocate a socket. This socket provides an endpoint that clients connect to.

A socket is actually an index into a table of connections, so socket numbers are usually assigned in ascending order. In the C language, the programmer calls the `socket()` function to allocate a new socket, as shown in the following example:

```
s = socket(AF_INET, SOCK_STREAM, 0);
```

The `socket()` function requires the address family (`AF_INET`), the type of socket (`SOCK_STREAM`), and the particular networking protocol to use (when `0` is specified, the system automatically uses the appropriate protocol for the specified socket type). A new socket is allocated and returned.

### `bind()`

At this point, an entry in the table of communications has been reserved for your application program. However, the socket has no port or IP address associated with it until you use the `bind()` function, which requires the following:

- The socket the server was just given
- The number of the port on which the server wishes to provide its service
- The IP address of the network connection on which the server is listening (to understand what is meant by “listening”, see “listen()”)

In C language, the server puts the port number and IP address into a `sockaddr_in` structure, passing it and the socket to the `bind()` function. For example:

```
bind(s, (struct sockaddr *)&server, sizeof(struct sockaddr_in));
```

### `listen()`

After the `bind`, the server has specified a particular IP address and port. Now it must notify the system that it intends to listen for connections on this socket. In C, the `listen()` function puts the socket into passive open mode and allocates a backlog queue of pending connections. In passive open mode, the socket is open for clients to contact. For example:

```
listen(s, backlog_number);
```

The server gives the socket on which it will be listening and the number of requests that can be queued (known as the *backlog\_number*). If a connection request arrives before the server can process it, the request is queued until the server is ready.

## accept()

Up to this point, the server has allocated a socket, bound the socket to an IP address and port, and issued a passive open. The next step is for the server actually to establish a connection with a client. The `accept()` call blocks the server until a connection request arrives, or, if there are connection requests in the backlog queue, until a connection is established with the first client in the queue. The following is an example of the `accept()` call:

```
client_sock = accept(s, &clientaddr, &addrlen);
```

The server passes its socket to the `accept()` call. When the connection is established, the `accept()` call returns a new socket representing the connection with the client. When the server wishes to communicate with the client or end the connection, it uses this new socket, `client_sock`. The original socket `s` is now ready to accept connections with other clients. The original socket is still allocated, bound, and opened passively. To accept another connection, the server calls `accept()` again. By repeatedly calling `accept()`, the server can establish almost any number of connections at once.

## select()

The server is now ready to start handling requests on this port from any client with the server's IP address and port number. Up to this point, it has been assumed that the server will be handling only one socket. However, an application program is not limited to one socket. Typically, a server listens for clients on a particular socket but allocates a new socket for each client it handles. For maximum performance, a server should operate only on those sockets that are ready for communication. The `select()` call allows an application program to test for activity on a group of sockets.

**Note:** The `select()` function can also be used with other descriptors, such as file descriptors, pipes, or character special files.

To allow you to test any number of sockets with just a single call to `select()`, place the sockets to test into a bit set, passing the bit set to the `select()` call. A *bit set* is a string of bits where each possible member of the set is represented by a 0 or a 1. If the member's bit is 0, the member is not in the set. If the member's bit is 1, the member is in the set. Sockets are actually small integers. If socket 3 is a member of a bit set, then the bit that represents it is set to 1 (on).

In C, the functions to manipulate the bit sets are the following:

### FD\_SET

Sets the bit corresponding to a socket

### FD\_ISSET

Tests whether the bit corresponding to a socket is set or cleared

### FD\_ZERO

Clears the whole bit set

### FD\_CLR

Clears a bit within the bit set

To be active, a socket is ready for reading data or for writing data, or an exceptional condition may have occurred. Therefore, the server can specify three bit sets of sockets in its call to the `select()` function: one bit set for sockets on which to receive data; another for sockets on which to write data; and any sockets with exception conditions. The `select()` call tests each socket in each bit set for activity and returns only those sockets that are active.

A server that processes many clients at the same time can easily be written so that it processes only those clients that are ready for activity.

## The client perspective

The client first issues the `socket()` function call to allocate a socket on which to communicate:

```
s = socket(AF_INET, SOCK_STREAM, 0);
```

To connect to the server, the client places the port number and the IP address of the server into a `sockaddr_in` structure. If the client does not know the server's IP address, but does know the server's host name, the `gethostbyname()` function or the `getaddrinfo()` function is called to translate the host name into its IP address.

The client then calls `connect()`. The following is an example of the `connect()` call:  
`connect(s, (struct sockaddr *)&server, sizeof(struct sockaddr_in));`

When the connection is established, the client uses its socket to communicate with the server.

## A typical TCP socket session

You can use TCP sockets for both passive (server) and active (client) processes. Whereas some functions are necessary for both types, some are role-specific. After you make a connection, it exists until one of the following has occurred:

- The socket is closed by client or server
- A shutdown is performed by client or server for both read and write
- The socket is *unconnected* using a blank `sockaddr` structure with another `connect()` call to the socket

During the connection, data is either delivered or an error code is returned by TCP/IP.

See Figure 125 on page 436 for the general sequence of calls to be followed for most socket routines using TCP, or stream sockets.

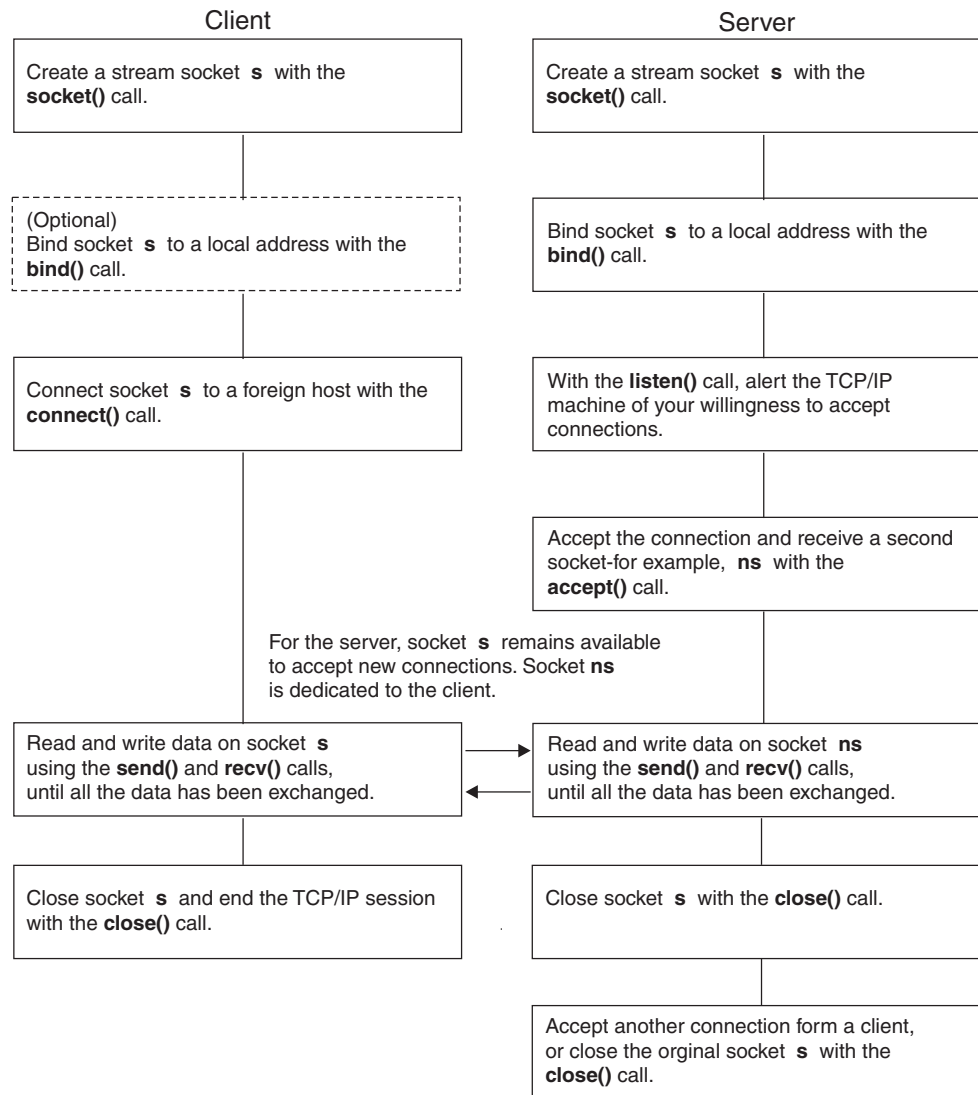

Figure 125. A typical stream socket session

## A typical UDP socket session

User Datagram Protocol (UDP) socket processes, unlike TCP socket processes, are not clearly distinguished by server and client roles. The distinction is between connected and unconnected sockets. An unconnected socket can be used to communicate with any host; but a connected socket, because it has a dedicated destination, can send data to, and receive data from, only one host.

Both connected and unconnected sockets send their data over the network without verification. Consequently, after a packet has been accepted by the UDP interface, the arrival and integrity of the packet cannot be guaranteed.

See Figure 126 on page 437 for the general sequence of calls to be followed for most socket routines using UDP, or datagram, sockets.

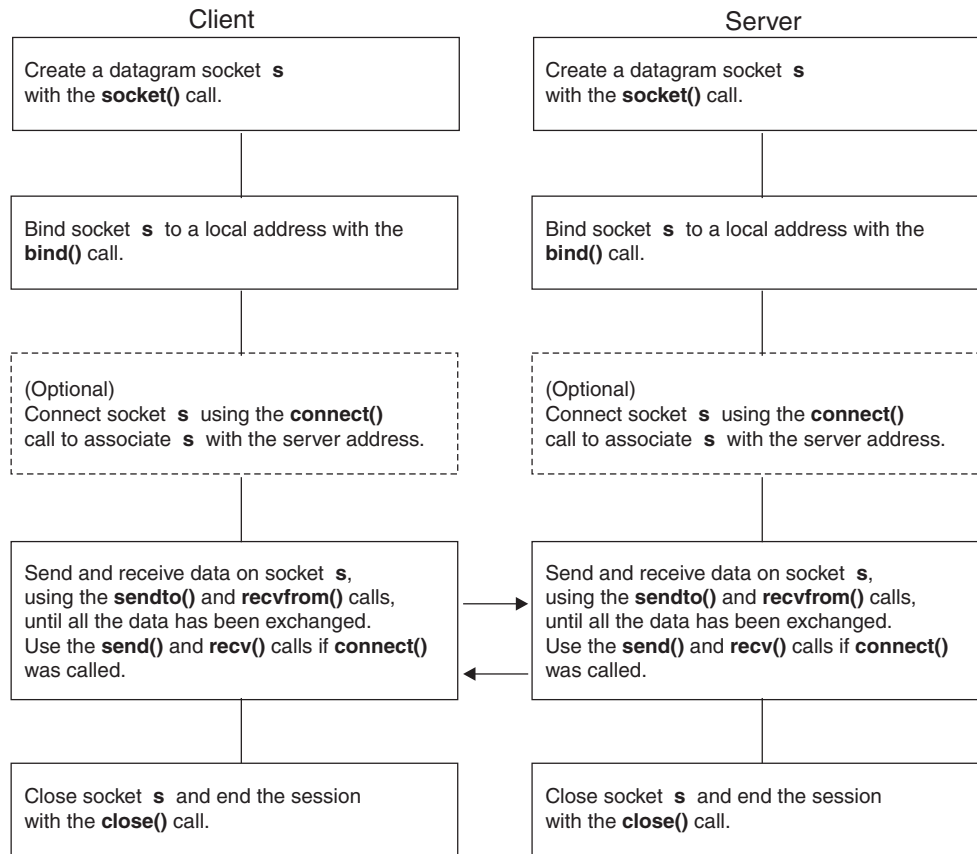

Figure 126. A typical datagram socket session

---

## Locating the server's port

In the client/server model, the server provides a resource by listening for clients on a particular port. Such application programs as FTP, SMTP, and Telnet listen on a *well-known port*—a port assigned for use to a specific application program or protocol. However, for your own client/server application programs, you need a method of assigning port numbers to represent the services you intend to provide. An easy method of defining services and their ports is to enter them into the `/etc/services` file or the `tcpip.ETC.SERVICES` data set. In C, the programmer uses the `getservbyname()` function or `getaddrinfo()` function to determine the port for a particular service. If the port number for a particular service changes, only the `/etc/services` file or the `tcpip.ETC.SERVICES` data set must be modified.

**Note:** TCP/IP is shipped with a `tcpip.ETC.SERVICES` file containing such well-known services as FTP, SMTP, and Telnet.

---

## Network application example

The following example illustrates using socket functions in a network application program. The steps are written using many of the basic socket functions, C socket syntax, and conventions described in this book.

1. First, an application program must get a socket descriptor using the `socket()` call, as in the example listed in Figure 127 on page 438. For a complete



description, see *z/OS XL C/C++ Runtime Library Reference*.

---

```
#include <sys/socket.h>
:
:
int s;
:
:
s = socket(AF_INET, SOCK_STREAM, 0);
```

---

Figure 127. An application using `socket()`

The code fragment in Figure 127 allocates a socket descriptor `s` in the Internet address family. The *domain* parameter is a constant that specifies the domain where the communication is taking place. A *domain* is the collection of application programs using the same addressing convention. *z/OS UNIX* supports three domains: `AF_INET`, `AF_INET6`, and `AF_UNIX`. The *type* parameter is a constant that specifies the type of socket, which can be `SOCK_STREAM`, or `SOCK_DGRAM`.

The *protocol* parameter is a constant that specifies the protocol to use. For `AF_INET`, it can be set to `IPPROTO_UDP` for `SOCK_DGRAM` and `IPPROTO_TCP` for `SOCK_STREAM`. Passing `0` chooses the default protocol. If successful, the `socket()` call returns a positive integer socket descriptor. For `AF_UNIX`, the protocol parameter *must* be `0`. These values are defined in the `netinet/in.h` include file.

2. After an application program has a socket descriptor, it can explicitly bind a unique address to the socket, as in the example listed in Figure 128. For a complete description, see *z/OS XL C/C++ Runtime Library Reference*.

---

```
int bind(int s, struct sockaddr *name, int namelen);
:
:
int rc;
int s;
struct sockaddr_in myname;

/* clear the structure to be sure that the sin_zero field is clear */
memset(&myname, 0, sizeof(myname));
myname.sin_family = AF_INET;
myname.sin_addr = inet_addr("129.5.24.1");
/* specific interface */
myname.sin_port = htons(1024);
:
:
rc = bind(s, (struct sockaddr *) &myname,
sizeof(myname));
```

---

Figure 128. An application using `bind()`

This example binds socket descriptor `s` to the address `129.5.24.1` and port `1024` in the Internet domain. Servers must bind to an address and port to become accessible to the network. The example in Figure 128 shows two useful utility routines:

- `inet_addr()` takes an IPv4 Internet address in dotted-decimal form and returns it in network byte order. Note that the `inet_pton()` function can take either an IPv4 or IPv6 Internet address in its standard text presentation form and return it in its numeric binary form. For a complete description, see *z/OS XL C/C++ Runtime Library Reference*.

- `htons()` takes a port number in host byte order and returns the port in network byte order. For a complete description, see *z/OS XL C/C++ Runtime Library Reference*.

Figure 129 shows another example of the `bind()` call. It uses the utility routine `gethostbyname()` to find the Internet address of the host, rather than using `inet_addr()` with a specific address.

---

```
int bind(int s, struct sockaddr_in name, int namelen);
:
:
int rc;
int s;
char *hostname = "myhost";
struct sockaddr_in myname;
struct hostent *hp;

    hp = gethostbyname(hostname);

    /*clear the structure to be sure that
the sin_zero field is clear*/
    memset(&myname,0,sizeof(myname));
    myname.sin_family = AF_INET;
    myname.sin_addr.s_addr = *((ip_addr_t
*)hp->h_addr);
    myname.sin_port = htons(1024);
:
:
rc = bind(s,(struct
sockaddr *) &myname, sizeof(myname));
```

---

Figure 129. A `bind()` function using `gethostbyname()`

3. After binding to a socket, a server that uses stream sockets must indicate its readiness to accept connections from clients. The server does this with the `listen()` call, as illustrated in the example in Figure 130.

---

```
int listen(int s, int backlog);
:
:
int s;
int rc;
:
:
rc = listen(s, 5);
```

---

Figure 130. An application using `listen()`

The `listen()` call tells the TCP/IP address space that the server is ready to begin accepting connections, and that a maximum of five connection requests can be queued for the server. Additional requests are ignored. For a complete description, see *z/OS XL C/C++ Runtime Library Reference*.

4. Clients using stream sockets begin a connection request by calling `connect()`, as shown in Figure 131 on page 440.

---

```

int connect(int s, struct sockaddr *name, int namelen);
:
:
int s;
struct sockaddr_in servername;
int rc;
:
:
memset(&servername, 0, sizeof(servername));
servername.sin_family = AF_INET;
servername.sin_addr = inet_addr("129.5.24.1");
servername.sin_port = htons(1024);
:
:
rc = connect(s, (struct sockaddr *) &servername,
sizeof(servername));

```

---

*Figure 131. An application using connect()*

The connect() call attempts to connect socket descriptor *s* to the server with an address *servername*. This could be the server that was used in the previous bind() example. The connect request is completed immediately and returns control to the caller, regardless of the server accepting the connection. After a successful return, the socket descriptor *s* is associated with the connection to the server. For a complete description, see *z/OS XL C/C++ Runtime Library Reference*.

5. Servers using stream sockets accept a connection request with the accept() call, as shown in the example listed in Figure 132.

---

```

int accept(int s, struct sockaddr *addr, int *addrlen);
:
:
int clientsocket;
int s;
struct sockaddr clientaddress;
int addrlen;
:
:
addrlen = sizeof(clientaddress);
:
:
clientsocket = accept(s, &clientaddress, &addrlen);

```

---

*Figure 132. An application using accept()*

When a connection request is accepted on socket descriptor *s*, the name of the client and length of the client name are returned, along with a new socket descriptor. The new socket descriptor is associated with the client that began the connection, and *s* is again available to accept new connections. For a complete description, see *z/OS XL C/C++ Runtime Library Reference*.

6. Clients and servers have many calls from which to choose for data transfer. The read() and write(), readv() and writev(), and send() and recv() calls can be used only on sockets that are in the connected state. The sendto() and recvfrom(), and sendmsg() and recvmsg() calls can be used at any time on datagram sockets. The example listed in Figure 133 on page 441 illustrates the use of send() and recv().

---

```

int send(int socket, char *buf, int buflen, int flags);
int recv(int socket, char *buf, int buflen, int flags);
:
:
int bytes_sent;
int bytes_received;
char data_sent[256];
char data_received[256];
int s;
:
:
bytes_sent = send(s, data_sent,
sizeof(data_sent), 0);
:
:
bytes_received = recv(s,
data_received, sizeof(data_received), 0);

```

---

Figure 133. An application using `send()` and `recv()`

The example in Figure 133 shows an application program sending data on a connected socket and receiving data in response. The flags field can be used to specify additional options to `send()` or `recv()`, such as sending out-of-band data. For more information see *z/OS XL C/C++ Runtime Library Reference*.

7. If the socket is not in a connected state, additional address information must be passed to `sendto()` and can be optionally returned from `recvfrom()`. An example of the use of the `sendto()` and `recvfrom()` calls is listed in Figure 134.

---

```

int sendto(int socket, char *buf, int buflen, int flags,
struct sockaddr *addr, int addrlen);
int recvfrom(int socket, char *buf, int buflen, int flags,
struct sockaddr *addr, int *addrlen);
:
:
int bytes_sent;
int bytes_received;
char data_sent[256];
char data_received[256];
struct sockaddr_in to;
struct sockaddr_from;
int addrlen;
int s;
:
:
memset(&to, 0, sizeof(to));
to.sin_family = AF_INET;
to.sin_addr = inet_addr("129.5.24.1");
to.sin_port = htons(1024);
:
:
bytes_sent = sendto(s, data_sent,
sizeof(data_sent), 0, &to, sizeof(to));
:
:
addrlen = sizeof(from); /* must be initialized */
bytes_received = recvfrom(s, data_received,
sizeof(data_received), 0, &from, &addrlen);

```

---

Figure 134. An application using `sendto()` and `recvfrom()`

The `sendto()` and `recvfrom()` calls take additional parameters that allow the caller to specify the recipient of the data or to be notified of the sender of the data. For more information see *z/OS XL C/C++ Runtime Library Reference*.

Usually, `sendto()` and `recvfrom()` are used for datagram sockets, and `send()` and `recv()` are used for stream sockets.

8. The `writenv()`, `readv()`, `sendmsg()`, and `recvmsg()` calls provide the additional features of *scatter and gather data*—two related operations where data is received and stored in multiple buffers (scatter data), and then taken from

multiple buffers and transmitted (gather data). Scattered data can reside in multiple data buffers. The `writv()` and `sendmsg()` calls gather the scattered data and send it. The `readv()` and `recvmsg()` calls receive data and scatter it into multiple buffers.

9. Applications can handle multiple descriptors. In such situations, use the `select()` call to determine the descriptors that have data to be read, those that are ready for data to be written, and those that have pending exceptional conditions. An example of how the `select()` call is used is listed in Figure 135.

---

```
fd_set readsocks;
fd_set writsocks;
fd_set exceptsocks;
struct timeval timeout;
int number_of_sockets;
int number_found;
:
:
/* number_of_sockets previously set to the socket number of largest
 * integer value.
 * Clear masks out.
 */
FD_ZERO(&readsocks);; FD_ZERO(&writsocks); FD_ZERO(&exceptsocks);
/* Set masks for socket s only */
FD_SET(s, &readsocks)
FD_SET(s, &writsocks)
FD_SET(s, &exceptsocks)
:
:
/* go into select wait for 5 minutes waiting for socket s to become
ready or the timer has popped*/
rc = select(number_of_sockets+1,
            &readsocks, &writsocks, &exceptsocks, &timeout);
:
:
/* Check rc for condition set upon exiting select */
number_found = select(number_of_sockets,
                     &readsocks, &writsocks, &exceptsocks, &timeout);
```

---

Figure 135. An application using `select()`

In this example, the application program uses bit sets to indicate that the sockets are being tested for certain conditions and also indicates a timeout. If the timeout parameter is `NULL`, the `select()` call blocks until a socket becomes ready. If the timeout parameter is nonzero, `select()` waits up to this amount of time for at least one socket to become ready on the indicated conditions. This is useful for application programs servicing multiple connections that cannot afford to block, waiting for data on one connection. For a complete description, see *z/OS XL C/C++ Runtime Library Reference*.

10. In addition to `select()`, application programs can use the `ioctl()` or `fcntl()` calls to help perform asynchronous (nonblocking) socket operations. An example of the use of the `ioctl()` call is listed in Figure 136 on page 443.

---

```

int ioctl(int s, unsigned long command, char *command_data);
:
:
int s;
int dontblock;
char buf[256];
int rc;
:
:
dontblock = 1;
:
:
rc = ioctl(s, FIONBIO, (char *) &dontblock);
:
:
if (((rc=recv(s, buf, sizeof(buf),
0)) < 0)&&(errno == EWOULDBLOCK))
/* no data available */
else
/* either got data or some other error occurred */

```

---

Figure 136. An Application Using `ioctl()`

This example causes the socket descriptor `s` to be placed into nonblocking mode. When this socket is passed as a parameter to calls that would block, such as `recv()` when data is not present, it causes the call to return with an error code, and the global `errno` value is set to `EWOULDBLOCK`. Setting the mode of the socket to be nonblocking allows an application program to continue processing without becoming blocked. For a complete description, see *z/OS XL C/C++ Runtime Library Reference*.

11. A socket descriptor, `s`, is deallocated with the `close()` call. Figure 137 shows an example. For a complete description, see *z/OS XL C/C++ Runtime Library Reference*.

---

```

int close(int s);
:
:
int rc;
int s;
rc = close(s);

```

---

Figure 137. An application using `close()`

---

## Using common INET

With Common INET (CINET), you have the capability to define up to 32 `AF_INET` or dual `AF_INET/AF_INET6` transport providers or stacks. The stacks can all be active at the same time. The information for modifying `BPXPRMxx` and bringing up Common INET is in *z/OS UNIX System Services Planning*.

For a server that you want to be able to listen to all of the available stacks at the same time, specify `INADDR_ANY` and it will be listening to all at once. Note that for an IPv6 server, `IN6ADDR_ANY` can be specified allowing the server to listen for IPv4 and IPv6 connections from all stacks.

The `z/OS UNIX` Common INET layer performs a multiplexing/demultiplexing function when more than one stack is activated under `z/OS UNIX`. Each stack has its own home IP addresses and when a program binds to a specific IP address that socket becomes associated with the one stack that is that IP address. When a program binds to `NADDR_ANY (0.0.0.0)` or `IN6ADDR_ANY (:::)`, the socket remains available to all the stacks.

There are three ways that an INADDR\_ANY or IN6ADDR\_ANY program can associate itself with a single stack:

- Call `setibmopt (IBMTCP_IMAGE)` - This sets a process so all future `socket ()` calls create sockets with only the one specified stack.
- The `_BPXX_SETIBMOPT_TRANSPORT` environment variable can be used in the `PARM=` parameter of an MVS started proc to effectively issue a SETIBMOPT outside of the program.
- Call `ioctl (SIOCSETRTTD)` - This associates an existing socket with the one specified stack, removing the others.

Also, you should be able to set up things so `gethostbyname ()` or `getaddrinfo ()` returns the home IP address of the local TCP/IP you are interested. With that, you can issue a specific `bind ()` to that IP address. This may not be useful though, if that stack has multiple IP addresses and you really want to use INADDR\_ANY to service all of them. Applications can bind to IN6ADDR\_ANY to service both Ipv4 and Ipv6 clients when TCP/IP is enabled for Ipv6.

---

## Compiling and binding

This section describes how to bind, load, and run z/OS XL C programs containing z/OS UNIX sockets. This information is specific to the z/OS UNIX application program interface and assumes that you are familiar with the information on compiling and binding z/OS UNIX application programs in *z/OS XL C/C++ Programming Guide* and *z/OS Language Environment Programming Guide*. C++ programs can also use z/OS UNIX sockets, but C++ programs cannot use Berkley Sockets, they must always use X/Open Sockets.

You compile and bind your sockets application program in the same way as for any other C language program. The process is shown conceptually in Figure 138 on page 445. You must make sure that the z/OS UNIX socket application programs have access to the files they need to compile and bind.

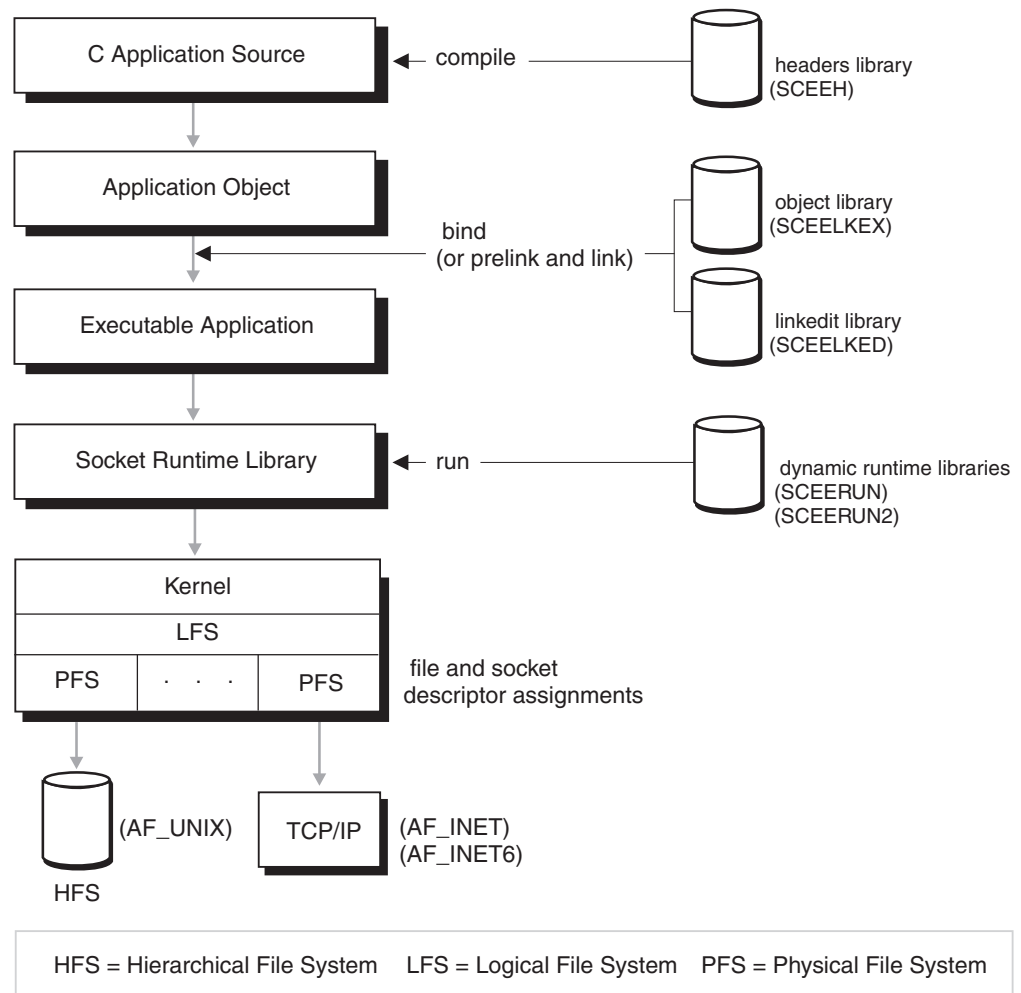

Figure 138. A conceptual overview of the compile, bind, and run steps

As shown, whether an application program's I/O request is targeted at the network (TCP/IP) or at a file, the z/OS UNIX logical file system (LFS) will route the request to the appropriate physical file system (PFS).

If your C language statements contain information, such as sequence numbers, which are not part of the input for the z/OS XL C compiler, you must include the following pragma directive in your program:

```
#pragma margins(1,72)
```

**Note:** In order to use AF\_INET sockets, you must have release 3.1 or a later level of TCP/IP installed on your system. In order to use AF\_INET6 sockets, you must have release z/OS V1R4 or later of TCP/IP installed on your system.

## Using TCP/IP APIs

If you will be using the TCP/IP socket API, also called non-Berkeley sockets, you will need to read and understand this section.

When a XL C/C++ application program running under z/OS UNIX needs to communicate with another program that is running simultaneously, it needs to



exploit, from within itself, both z/OS UNIX POSIX.1 and one or more of the following application programming interfaces (APIs) provided with the IBM product TCP/IP:

- Socket APIs
  - C sockets
  - Inter-User Communication Vehicle (IUCV) sockets
- X Window System interface
- remote procedure call (RPC)

With the exception of described restrictions, you can code z/OS UNIX XL C/C++ application programs to take advantage of the documented APIs available as part of the Communications Server IP.

z/OS UNIX application programs can use socket API calls from the TCP/IP product to access UNIX file system files or MVS data sets, communicate with other systems running TCP/IP, or establish communication with and request services from a workstation system acting as an X Windows server.

**Note:** For UNIX file system file access to TCP/IP, the TCP/IP socket API calls must be used instead of the POSIX file access functions to preserve the uniqueness of file descriptors in the UNIX file system.

Before you attempt to code your application program to use TCP/IP APIs, you should understand the X Windows protocol running on the workstations that will be used as application clients. You will also need to know how to invoke X Windows to create a connection to the server on the workstation or z/OS system.

## Restrictions for using z/OS TCP/IP API with z/OS UNIX

The restrictions can be grouped into categories:

- **Header Files**

- *Header file conflicts between TCP/IP and z/OS XL C/C++.* z/OS XL C/C++ and TCP/IP have header files with the same name and overlapping function. For example, both have a `types.h` file. If you use TCP/IP API functions in your application but the z/OS XL C/C++ header file is searched for and used, the TCP/IP function does not work as intended.

You can circumvent this problem by developing your application program with separate compilation source files for TCP/IP function and normal z/OS XL C/C++ function. You can then compile the TCP/IP source files separately from the normal z/OS XL C/C++ source files. Use the `c89 -I` option to point to the MVS data sets to search for the TCP/IP header files. Finally, you can bind all the application object files together to produce the application executable file. For the bind step, use the `c89 -l` option to point to the correct TCP/IP libraries on MVS. For example:

```
c89 -I '//tcpip.sezacmac' pgm.c -l '//tcpip.sezarnt1' ...
```

- **TCP/IP socket API.** Both z/OS UNIX POSIX.1-defined support and the TCP/IP for z/OS socket API use a small subset of common function calls that cannot be resolved correctly between them:
  - `close()`
  - `fcntl()`
  - `read()`
  - `write()`

Use of these calls should be reserved for one or the other, but not both, of these programming interfaces. For example, if an application program is written to use the `open()`, `close()`, `read()`, and `write()` functions for z/OS TCP/IP socket communication, it cannot use them for UNIX file system file access. z/OS XL C/C++ stream I/O functions (`fopen()`, `fclose()`, `fread()`, and `fwrite()`) must be used for UNIX file system file access. See *z/OS Communications Server: IP Sockets Application Programming Interface Guide and Reference* for more information.

- **Creating child processes.** Generally speaking, an application program cannot have a parent process open resources—in this case sockets—and then support those resources for a child process created through a `fork()` function or in a process following use of an `exec` function. The new child process does not inherit sockets from the parent process if forked. If the child process needs sockets, it must request TCP/IP for z/OS socket support independently of the parent process. In fact, if a child process is to be forked by an application program using TCP/IP sockets under z/OS UNIX, all MVS resources to be opened *should* be opened by the child process rather than by the parent process.

- **TCP/IP configuration file access.** An application executable file that uses TCP/IP APIs and was bound with the `c89` utility cannot locate the necessary TCP/IP configuration files, because they reside in MVS sequential data sets rather than in UNIX file system files.

To circumvent this problem, have the system programmer copy the TCP/IP configuration data sets into the `root` directory exactly as shown:

```
0PUT 'tcpip.tcpip.data' 'etc/resolv.conf' text
```

Copy the address of the name server, the name, and the domain name from `tcpip.HOST.LOCAL` to `\etc\hosts`. You should not copy the entire file directly because you only need the address and name. The entry in the `\etc\hosts` file follows the BSD format. The case of the filenames and the use of the quote characters as part of the name are *significant*. Use the TSO/E `0PUT` command to copy the MVS sequential data sets to the root directory. (Placing files in the root file system requires superuser authority.)

- **Program reentrancy.** The TCP/IP sockets and X Windows reentrant libraries must have a special C370LIB-directory member created for them before an application program using TCP/IP functions can be bound. The system administrator must run the C370LIB DIR function against the reentrant libraries to create it. The system administrator must do this once per library for an MVS system.

Specify the TCP/IP libraries to search on the `c89` utility when binding the application program. For example:

```
c89 -I'/'tcpip.sezacmac'" pgm.c -l "/'/'tcpip.sezarnt1'" ...
```

For information on C370LIB, see *z/OS XL C/C++ User's Guide*.

---

## Using z/OS UNIX sockets

To compile, each z/OS UNIX socket application program must have access to the following z/OS C include files in an MVS PDS or in the UNIX file system directory:

CEE.SCEEH.H	/usr/include
CEE.SCEEH.ARPA.H	/usr/include/arpa
CEE.SCEEH.NET.H	/usr/include/net
CEE.SCEEH.NETINET.H	/usr/include/netinet
CEE.SCEEH.SYS.H	/usr/include/sys

**Note:** The data set prefix for each of the previous files must match the name used at your installation. CEE is the default for z/OS Language Environment.

For **Berkeley SOCKETS** or **X/OPEN SOCKETS**, all you need are the z/OS C include files.

**Note:** The data set prefix for each of these files must match the name used at your installation. CEE is the default for the z/OS XL C library.

You must compile your application program using *all* include files in order to access the entire z/OS UNIX socket API. To compile a program written using a particular API, you must include certain files specific to that API even though your program may not require all of them.

See *z/OS XL C/C++ Runtime Library Reference*, which lists the header files that must be included for each type API. They may be different for **Berkeley Sockets** and **X/Open sockets**.

The following list describes the files that each z/OS UNIX socket application program must have access to in order to bind:

- CEE.SCEELKED contains stub routines in the link library that are used to resolve external references to z/OS XL C and z/OS UNIX socket APIs.
- CEE.SCEELKEX contains LONGNAME stub routine object modules for a large portion of the Language Environment function library, including the z/OS C and z/OS UNIX socket APIs. When you IPA Link your application program, place the SCEELKEX library ahead of the SCEELKED Load Module library in the search order. This preserves long runtime function names in the object module and listings generated by IPA Link. When you bind your application program, place the SCEELKEX library ahead of the SCEELKED Load Module library in the search order. This preserves long runtime function names in the executable module and listings generated by the binder.
- CEE.SCEERUN contains the z/OS XL C and z/OS UNIX socket runtime libraries.

## Compiling under MVS batch for Berkeley sockets

You can use several methods to compile, bind, and run your sockets program. This section describes one way to compile and bind your C source program, under MVS batch, using the IBM-supplied EDCCB cataloged procedure.

**Note:** If you are planning on developing your application as a C++ application and use sockets, you must use XOpen Sockets for your application. See section “Compiling under MVS batch for X/Open sockets” on page 449 for more information.

### Sample cataloged procedure additions and changes

The following steps describe how to compile, and bind your program. For more information about the z/OS XL C/C++ cataloged procedures refer to the *z/OS XL C/C++ User's Guide*.

You must make changes to the cataloged procedure, which is supplied with z/OS XL C/C++ Compiler. After you select the procedure you want to use from those available in the XL C/C++ supplied data set, CBC.SCCNPRC, you modify it. For example, if you choose EDCC then you modify it as follows:

1. Change the CPARM parameters to:  

```
CPARM='DEF(MVS,_OE_SOCKETS,_POSIX1_SOURCE=1),RENT,LO',
```

RENT is the reentrant option and L0 is the long name option. You must specify these options to use POSIX functions `read()`, `write()`, `fcntl()`, and `close()` that are all included in z/OS XL C.

You must specify the feature test macro, `_POSIX1_SOURCE=1` to access the `read()`, `write()`, `fcntl()`, and `close()` functions in the z/OS XL C include files. Or, if you choose to access all z/OS UNIX POSIX functions supported by z/OS XL C, you can specify the `_OPEN_SYS` feature test macro. The `_OE_Sockets` feature test macro exposes the socket-related definitions in all of the include files. For information on binding C code compiled with the RENT and LONGNAME options, see *z/OS XL C/C++ User's Guide*.

2. To run your program under TSO/E, type the following:

```
CALL 'USER.MYPROG.LOAD(PROGRAM1)' 'POSIX(ON)'
```

This loads the runtime library from CEE.SCEERUN and/or SCEERUN2.

To use the POSIX z/OS XL C functions, you *must* either specify the runtime option `POSIX(ON)`, or include the following statement in your C source program:

```
#pragma runopts(POSIX(ON))
```

The *z/OS XL C/C++ Runtime Library Reference* identifies the POSIX z/OS XL C functions, in the standards information at the beginning of each function description.

### **Compiling under MVS batch with X windows for Berkeley sockets**

If you are using z/OS UNIX sockets with the latest announced release level of TCP/IP X Windows, and compiling and binding under MVS batch, you *must* bind your application program with the latest announced release level of TCP/IP X Windows libraries that are enabled for use with z/OS UNIX sockets.

For a complete discussion of compiling and binding z/OS UNIX sockets with TCP/IP, see *z/OS Communications Server: IP Programmer's Guide and Reference*.

### **Compiling using the c89 utility for Berkeley sockets**

If you want to use the c89 utility to compile and bind your program, you must use the following define options on the c89 command:

```
-D MVS  
-D _OE_SOCKETS
```

For more information about compiling and binding, see *z/OS XL C/C++ User's Guide*.

### **Compiling using c89 with X Windows**

See *z/OS Communications Server: IP Programmer's Guide and Reference* for a complete discussion of compiling and binding with X Windows.

## **Compiling under MVS batch for X/Open sockets**

You can use several methods to compile, bind, and run your sockets program. This section describes one way to compile and link-edit your C source program, under MVS batch, using the IBM-supplied EDCCB cataloged procedure.

### **Sample cataloged procedure additions and changes**

The following steps describe how to compile, bind, and run your program. For more information about the z/OS XL C/C++ cataloged procedures refer to the *z/OS XL C/C++ User's Guide*.

You must make changes to the cataloged procedure, which is supplied with z/OS XL C/C++ Compiler. After you select the procedure you want to use from those available in the XL C/C++ supplied data set, CBC.SCCNPRC, you modify it. For example, if you choose EDCCB then you modify it as follows:

1. Change the CPARM parameters to:

```
CPARM='DEF(MVS,_XOPEN_SOURCE_EXTENDED=1,_POSIX1_SOURCE=1),
RENT,L0',
```

RENT is the reentrant option and L0 is the long name option. You must specify these options to use POSIX functions `read()`, `write()`, `fcntl()`, and `close()` that are all included in z/OS XL C.

You must specify the feature test macro, `_POSIX1_SOURCE=1` to access the `read()`, `write()`, `fcntl()`, and `close()` functions in the z/OS XL C include files. Or, if you choose to access all z/OS UNIX POSIX functions supported by z/OS XL C, you can specify the `_OPEN_SYS` feature test macro. The `_XOPEN_SOURCE_EXTENDED` feature test macro exposes the socket-related definitions in all of the include files.

**Note:** Because you are now required to compile with the RENT and LONGNAME options, you must bind your sockets application with the z/OS binder.

2. To run your program under TSO/E, type the following:

```
CALL 'USER.MYPROG.LOAD(PROGRAM1)' 'POSIX(ON)/'
```

To use the POSIX z/OS XL C functions, you *must* either specify the runtime option `POSIX(ON)`, or include the following statement in your C source program:

```
#pragma runopts(POSIX(ON))
```

### Using API data sets and files for sockets

- CEE.SCEELKED contains stub routines in the link library that are used to resolve external references to z/OS XL C and z/OS UNIX socket APIs.
- CEE.SCEELKEX contains LONGNAME stub routine object modules for a large portion of the Language Environment function library, including the z/OS C and z/OS UNIX socket APIs. When you IPA Link or bind your application program, place the SCEELKEX library ahead of the SCEELKED Load Module library in the search order. This preserves long runtime function names in the object module and listings generated by IPA Link or the binder.
- CEE.SCEERUN contains the z/OS XL C and z/OS UNIX socket runtime libraries.

#### Notes:

1. The data set prefix for each the previous files must match the name used at your installation. CEE is the default for z/OS Language Environment.
2. Applications developed for Open Sockets can continue to use the linkage editor but cannot be compiled.

---

## Understanding the X/Open Transport Interface (XTI)

The X/Open Transport Interface (XTI) specification defines an independent transport-service interface that allows multiple users to communicate at the transport level of the OSI reference model. Transport-layer protocols support the following characteristics:

- connection establishment
- state change support
- event handling

- data transfer
- option manipulation

Although all transport-layer protocols support these characteristics, they vary in their level of support and their interpretation of format.

## Transport endpoints

A transport endpoint specifies a communication path between a transport user and a specific transport provider, which is identified by a local file descriptor (`fd`). When a user opens a transport endpoint, a local file descriptor `fd` is returned which identifies the endpoint. A transport provider is defined to be the transport protocol that provides the services of the transport layer. All requests to the transport provider must pass through a transport endpoint. The file descriptor `fd` is returned by the function `t_open()` and is used as an argument to the subsequent functions to identify the transport endpoint. A transport endpoint can support only one established transport connection at a time.

To be active, a transport endpoint must have a transport address associated with it by the `t_bind()` function. A transport connection is characterized by the association of two active endpoints, made by using the transport connection establishment functions `t_listen()`, `t_accept()`, `t_connect()`, and `t_rcvconnect()`.

## Transport providers for X/Open Transport Interface

The transport layer may comprise one or more transport providers at the same time. The identifier parameter of the transport provider passed to the `t_open()` function determines the required transport provider. To keep the applications portable, the identifier parameter of the transport provider should not be hard-coded into the application source code.

Currently, the only valid value for the *identifier* parameter for the `t_open()` function is `/dev/tcp`, indicating the TCP transport provider. Even though no device with this pathname actually exists, the library uses this value to determine which transport provider to use.

## General restrictions for z/OS UNIX

The following restrictions apply when you use XTI under z/OS UNIX.

- The file descriptor number must not exceed the limit of 65535 for XTI endpoints.
- If an endpoint is being shared among multiple processes, events such as, `T_LISTEN`, `T_DATA`, and `T_EXDATA`, can be consumed by another process in the time between calls to `t_look()` and `t_rcv()` or `t_accept()`. In order to avoid processes not being aware of events occurring on endpoints, you should provide explicit synchronization mechanisms between processes
- If an endpoint is shared:
  - The process that issues the `t_listen()` should also issue for the pending connection `t_accept()`.
  - If any other process accesses the endpoint in the time between the listen and the accept, the behavior is undefined. In order to avoid this, you should provide explicit synchronization between processes.
- If a process dies while an endpoint it was accessing is in `T_INCON` state, it is impossible for any other sharing endpoints to bring it out of that state.

- If access to endpoints is shared, the participating processes are responsible for serialization of access to the endpoints. If no synchronization is performed, the behavior is undefined.
- Functions are thread-safed; therefore, no two threads in a process can manipulate an endpoint at the same time. Serialization of access to endpoints beyond this level is the responsibility of the threads sharing the endpoint.



---

## Chapter 30. Interprocess communication using z/OS UNIX

z/OS UNIX offers software vendors and customers several ways for programming processes to communicate:

- Message queues
- Semaphores
- Shared memory
- Memory mapping
- Issuing TSO commands from a shell

These forms of interprocess communication extend the possibilities provided by the simpler forms of communication: pipes, named pipes or FIFOs, signals, and sockets. Like these forms, message queues, semaphores, and shared memory are used for communication between processes. (Sockets are the most common form of interprocess communication across different systems.) For more information on these communication forms, see *z/OS UNIX System Services Planning*.

---

### Message queues

XPG4 provides a set of C functions that allow processes to communicate through one or more message queues in an operating system's kernel. A process can create, read from, or write to a message queue. Each message is identified with a "type" number, a length value, and data (if the length is greater than 0).

A message can be read from a queue based on its type rather than on its order of arrival. Multiple processes can share the same queue. For example, a server process can handle messages from a number of client processes and associate a particular message type with a particular client process. Or the message type can be used to assign a priority in which a message should be dequeued and handled.

A common client/server implementation on the same system uses two message queues for communication between client and server. An inbound message queue allows group write access and limits read access to the server. An outbound message queue allows universal read access and limits write access to the server. This implementation allows users to place invalid messages on the inbound queue or remove messages belonging to another process from the outbound queue. To solve this problem, you can use two new z/OS message queue types, `ipc_SndTypePID` and `ipc_RcvTypePID` to enforce source and destination process identification.

Create the inbound queue to the server with `ipc_SndTypePID` and the outbound queue from the server with `ipc_RcvTypePID`. This arrangement guarantees that the server knows the process ID of the client, and that the client is the only process that can receive the server's returned message. The server can also issue `msgrcv()` with `TYPE=0` to see if any messages belong to process IDs that have gone away. Security checks on clients are not needed, since clients are unable to receive messages intended for another process.

The `ipc_PL0` constants provide possible message queue performance improvements based on workload. For information on the `ipc_PL0` constants, see the `msgget()` function in the *z/OS XL C/C++ Runtime Library Reference*.



---

## Semaphores

Semaphores, unlike message queues and pipes, are not used for exchanging data, but as a means of synchronizing operations among processes. A semaphore value is stored in the kernel and then set, read, and reset by sharing processes according to some defined scheme. A semaphore is created or an existing one is located with the `semget()` function. Typical uses include resource counting, file locking, and the serialization of shared memory.

A semaphore can have a single value or a set of values; each value can be binary (0 or 1) or a larger value, depending on the implementation. For each value in a set, the kernel keeps track of the process ID that did the last operation on that value, the number of processes waiting for the value to increase, and the number of processes waiting for the value to become 0.

If you define a semaphore set without any special flags, `semop()` processing obtains a kernel latch to serialize the semaphore set for each `semop()` or `semctl()` call. The more semaphores you define in the semaphore set, the higher the probability that you will experience contention on the semaphore latch. One alternative is to define multiple semaphore sets with fewer semaphores in each set. To get the least amount of latch contention, define a single semaphore in each semaphore set.

z/OS has added the `__IPC_BINSEM` option to `semget()`. The `__IPC_BINSEM` option provides significant performance improvement on `semop()` processing. `__IPC_BINSEM` can only be specified if you use the semaphore as a binary semaphore and do not specify `UNDO` on any `semop()` calls. `__IPC_BINSEM` also allows `semop()` to use special hardware instructions to further reduce contention. With `__IPC_BINSEM`, you can define many semaphores in a semaphore set without impacting performance.

---

## Shared memory

Shared memory provides an efficient way for multiple processes to share data (for example, control information that all processes require access to). Commonly, the processes use semaphores to take turns getting access to the shared memory. For example, a server process can use a semaphore to lock a shared memory area, then update the area with new control information, use a semaphore to unlock the shared memory area, and then notify sharing processes. Each client process sharing the information can then use a semaphore to lock the area, read it, and then unlock it again for access by other sharing processes.

Processes can also use shared mutexes and shared read-write locks to communicate. For more information on mutexes and read-write locks see “Synchronization primitives” on page 355.

---

## Memory mapping

In z/OS, a programmer can arrange to transparently map into a UNIX file system file process storage.

The use of memory mapping can reduce the number of disk accesses required when randomly accessing a file.

The related `mmap()`, `mprotect()`, `msync()`, and `munmap()` functions that provide memory mapping are part of the X/OPEN CAE Specification.

---

## TSO commands from a shell

In z/OS UNIX, users of the z/OS UNIX shells can issue TSO/E commands. The user simply enters the shell command `tso`, followed by a TSO command string. The user can specify whether the TSO command is to be run through the shell (in which case the output will be displayed on the screen) or through a TSO environment (in which case the command output will be written to the defined standard output). For more information about running the command through the shell or through a TSO environment, see *z/OS UNIX System Services Command Reference*.



---

## Chapter 31. Using templates in C++ programs

In C++, you can use a template to declare and define a set of related:

- Classes (including structs)
- Functions
- Static data members of template classes

Within an application, you can instantiate the same template multiple times with the same arguments or with different arguments. If you use the same arguments, the repeated instantiations are redundant. These redundant instantiations increase compilation time, increase the size of the executable, and deliver no benefit.

There are several basic approaches to the problem of redundant instantiations:

### Control implicit instantiation in the source code

To use this approach, you can use either of the following methods:

- Concentrate implicit instantiations of a specialization

Organize your source code so that object files contain fewer instances of each required instantiation and fewer unused instantiations. This is the least usable approach, because you must know where each template is defined and where each template instantiation is required.

- Use explicit instantiation declarations (C++11 only)

Support for explicit instantiation declarations can be enabled by setting the `LANGLVL(EXTENDED)` or `LANGLVL(EXTENDED0X)` compiler group suboptions. Explicit instantiation declarations give you the ability to suppress implicit instantiation of templates. This helps reduce the collective size of the object files. It may also reduce the size of the final executable if the suppressed symbol definitions are meant to be found in a shared library, or if the system linker is unable to always remove additional definitions of a symbol. This approach is described in “Using explicit instantiation declarations (C++11 only)” on page 462.

### Store instantiations in an include directory

Use the `TEMPINC` compiler option. If the template header and the template definition file have the required structure (described in “Using the `TEMPINC` compiler option” on page 458), each template instantiation is stored in a template include directory. If the compiler is asked to instantiate the same template again with the same arguments, it uses the stored version instead. This is the default.

### Store instantiation information in a registry

Use the `TEMPLATEREGISTRY` compiler option. Information about each template instantiation is stored in a template registry. If the compiler is asked to instantiate the same template again with the same arguments, it points to the instantiation in the first object file instead.

The `TEMPLATEREGISTRY` compiler option provides the benefits of the `TEMPINC` compiler option but does not require a specific structure for the template header and the template definition file.

**Note:** The `NOTEMPINC` and `TEMPLATEREGISTRY` compiler options are mutually exclusive.

---

## Using the TEMPINC compiler option

To use TEMPINC, you must structure your application as follows:

- Declare your class templates and function templates in template declaration files. This file must have the same file name as the template definition file and an extension or LLQ of .h. In the following example, the template declaration file is named stack.h.

You can identify a template declaration file in either of the following ways:

- In the UNIX file system: /usr/src/stack.h
- In a PDS: MYUSERID.USER.H(STACK)

- For each template declaration file, create a template definition file. This file must have the same file name as the template declaration file and an extension or LLQ of .c. For a class template, this file defines all of the member functions and static data members. For a function template, this file defines the function.

You can identify a template definition file in either of the following ways:

- In the UNIX file system: /usr/src/stack.c
- In a PDS: MYUSERID.USER.C(STACK)

- In your source program, specify an #include statement for each template declaration file.

- In each template declaration file, conditionally include the corresponding template definition file if the \_\_TEMPINC\_\_ macro is *not* defined.

This produces the following results:

- Whenever you compile with NOTEMPINC, the template definition file is included.
- Whenever you compile with TEMPINC, the compiler does not include the template definition file. Instead, the compiler looks for a file with the same name as the template declaration file and extension .c the first time it needs a particular instantiation. If the compiler subsequently needs the same instantiation, it uses the copy stored in the template include directory.

### TEMPINC example

This section contains example files and compilation code examples that show how to use the TEMPINC compiler option. The following types of files are shown:

- Two source files: stackadd.cpp and stackops.cpp
- A template declaration file: stack.h
- The corresponding template definition file: stack.c
- A function prototype: stackops.h

In this example section, note that:

1. Both source files include the template declaration file stack.h
2. Both source files include the function prototype stackops.h
3. The template declaration file conditionally includes the template definition file stack.c if it is compiled with NOTEMPINC.

Figure 139 on page 459 shows the first source file, stackadd.cpp.

---

```

#include <iostream.h>
#include "stack.h"           // 1
#include "stackops.h"       // 2

main() {
    Stack<int, 50> s;        // create a stack of ints
    int left=10, right=20;
    int sum;

    s.push(left);          // push 10 on the stack
    s.push(right);         // push 20 on the stack
    add(s);                 // pop the 2 numbers off the stack
                           // and push the sum onto the stack
    sum = s.pop();         // pop the sum off the stack

    cout << "The sum of: " << left << " and: " << right << " is: " << sum << endl;

    return(0);
}

```

---

Figure 139. *stackadd.cpp* file (*ccntmp3.cpp*)

Figure 140 is the source file, *stackops.cpp*.

---

```

#include "stack.h"           // 1
#include "stackops.h"       // 2

void add(Stack<int, 50>& s) {
    int tot = s.pop() + s.pop();
    s.push(tot);
    return;
}

```

---

Figure 140. *stackops.cpp* file (*ccntmp4.cpp*)

Figure 141 shows *stack.h*, which is the template declaration file.

---

```

#ifndef STACK_H
#define STACK_H

template <class Item, int size> class Stack {
public:
    void push(Item item); // Push operator
    Item pop();           // Pop operator
    int isEmpty(){
        return (top==0); // Returns true if empty, otherwise false
    }
    Stack() { top = 0; } // Constructor defined inline
private:
    Item stack[size];    // The stack of items
    int top;             // Index to top of stack
};

#ifdef __TEMPINC__
#include "stack.c"
#endif
#endif

```

---

Figure 141. *stack.h* file (*ccntmp2.h*)

Figure 142 on page 460 shows *stack.c*, which is the template definition file.

---

```

//stack.c
template <class Item, int size>
void Stack<Item,size>::push(Item item) {
    if (top >= size) throw size;
    stack[top++] = item;
}
template <class Item, int size>
Item Stack<Item,size>::pop() {
    if (top <= 0) throw size;
    Item item = stack[--top];
    return(item);
}

```

---

Figure 142. stack.c file (ccntmp1.c)

The stackops.h file (Figure 143) contains the prototype for the add function, which is used in both stackadd.cpp and stackops.cpp.

---

```

void add(Stack<int, 50>& s);

```

---

Figure 143. stackops.h File (ccntmp5.h)

Figure 144 contains the JCL to compile the source files; this JCL does the following:

1. Compiles both compilation units and creates the TEMPINC destination, which is a sequential file with the following data set name MYUSERID.TEMPINC
2. Compiles the template instantiation file in the TEMPINC destination.

---

```

//CC EXEC CBCC,
// INFILE='MYUSERID.USER.CPP(STACKADD)',
// OUTFILE='MYUSERID.USER.OBJ(STACKADD),DISP=SHR',
// CPARM='LSEARCH(USER.+)'
/*-----
//CC EXEC CBCC,
// INFILE='MYUSERID.USER.CPP(STACKOPS)',
// OUTFILE='MYUSERID.USER.OBJ(STACKOPS),DISP=SHR',
// CPARM='LSEARCH(USER.+)'
/*-----
//CC EXEC CBCC,
// INFILE='MYUSERID.TEMPINC',
// OUTFILE='MYUSERID.USER.OBJ,DISP=SHR',
// CPARM='LSEARCH(USER.+)'
/*-----
//BIND EXEC CBCBG,
// INFILE='MYUSERID.USER.OBJ(STACKADD)',
// OUTFILE='MYUSERID.USER.LOAD(STACKADD),DISP=SHR'
//BIND.OBJ DD DSN=MYUSERID.USER.OBJ,DISP=SHR
//BIND.SYSIN DD *
INCLUDE OBJ(STACKOPS)
INCLUDE OBJ(STACK)
/*

```

---

Figure 144. JCL to compile source Files and TEMPINC destination

Figure 145 on page 461 shows the syntax of how to compile the program within the z/OS shell.

---

```
export _CXX_CXXSUFFIX=cpp
c++ stackadd.cpp stackops.cpp
```

---

Figure 145. z/OS UNIX Syntax

## Regenerating the template instantiation file

The compiler builds a template instantiation file, in the UNIX file system tempinc directory or the TEMPINC PDS, corresponding to each template declaration file. With each compilation, the compiler may add information to the file but it never removes information from the file.

As you develop your program, you may remove template function references or reorganize your program so that the template instantiation files become obsolete. You can periodically delete the TEMPINC destination and recompile your program.

## TEMPINC considerations for shared libraries

In a traditional application development environment, different applications can share both source files and compiled files. When you use templates, applications can share source files but cannot share compiled files.

If you use TEMPINC:

- Each application must have its own tempinc destination.
- You must compile all of the files for the application, even if some of the files have already been compiled for another application.

Under MVS or z/OS UNIX System Services, you can easily assign a separate tempinc PDS or directory for each application.

---

## Using the **TEMPLATEDEPTH** compiler option

To instantiate a large number of nested templates, you can specify the instantiation depth of recursively instantiated templates with the **TEMPLATEDEPTH** compiler option. By specifying a value between 1 and **INT\_MAX** as the suboption of the **TEMPLATEDEPTH** compiler option, you can control the maximum number of recursively instantiated template specializations that are processed by the compiler.

The default of the option is **TEMPLATEDEPTH(300)**.

---

## Using the **TEMPLATEREGISTRY** compiler option

Unlike **TEMPINC**, the **TEMPLATEREGISTRY** compiler option does not impose specific requirements on the organization of your source code. Any program that compiles successfully with **NOTEMPINC** will compile with **TEMPLATEREGISTRY**.

The template registry uses "first come first served" algorithm:

- When a program references a new instantiation for the first time, it is instantiated in the compilation unit in which it occurs.
- When another compilation unit references the same instantiation, it is not instantiated. Thus, only one copy is generated for the entire program.



The instantiation information is stored in a template registry file. You must use the same template registry file for the entire program. Two programs cannot share a template registry file.

The default file name for the template registry file is `templreg` in the UNIX file system and `TEMPLREG` in batch (a sequential file), but you can specify any other valid file name to override this default. When cleaning your program build environment before starting a fresh or scratch build, you must delete the registry file along with the old object files.

## Recompiling related compilation units

If two compilation units, A and B, reference the same instantiation, the `TEMPLATEREGISTRY` compiler option has the following effect:

- If you compile A first, the object file A contains the code for the instantiation.
- When you later compile B, the object file for B contains a reference to the object file A.
- If you later change A so that it no longer references this instantiation, the reference in object B would produce an unresolved symbol error. When you recompile A, the compiler detects this problem and handles it as follows:
  - If the `TEMPLATERECOMPILE` compiler option is in effect, the compiler automatically recompiles B using the same compiler options that were specified for A.
  - If the `NOTEMPLATERECOMPILE` compiler option is in effect, the compiler issues a warning and you must manually recompile B.

## Switching from `TEMPINC` to `TEMPLATEREGISTRY`

Because the `TEMPLATEREGISTRY` compiler option does not impose any restrictions on the file structure of your application, it has less administrative overhead than `TEMPINC`. You can make the switch as follows:

- If your application compiles successfully with both `TEMPINC` and `NOTEMPINC`, you do not need to make any changes.
- If your application compiles successfully with `TEMPINC` but not with `NOTEMPINC`, you must change it so that it will compile successfully with `NOTEMPINC`. In each template declaration file, conditionally include the corresponding template definition file if the `__TEMPINC__` macro is *not* defined. This is illustrated in “`TEMPINC` example” on page 458.

---

## Using explicit instantiation declarations (C++11 only)

Syntactically, an explicit instantiation declaration is an explicit instantiation definition preceded by the `extern` keyword. This C++11 feature is controlled by the `LANGLVL(EXTENDED)` or `LANGLVL(EXTENDED0X)` compiler group suboptions, or by individual suboptions `LANGLVL(EXTERNTEMPLATE)` and `LANGLVL(NOEXTERNTEMPLATE)`. When multiple `LANGLVL` suboptions are applied, the last one wins. For example, the support for explicit instantiation declaration is disabled when `LANGLVL(NOEXTERNTEMPLATE)` is set. The default settings for `LANGLVL(EXTERNTEMPLATE)` are as follows:

<code>compat366</code>	<code>strict98</code>	<code>extended</code>	<code>extended0x</code>
N	N	Y	Y

There are several things to be considered when using explicit instantiation declarations:

1. (IBM extension) An explicit instantiation declaration of a class template specialization does not cause implicit instantiation of said specialization.
2. If, in a translation unit, a user-defined inline function is subject to an explicit instantiation declaration and not subject to an explicit instantiation definition:
  - implicit instantiation of said function will still occur regardless of whether it will be inlined or not.
  - (IBM extension) no out-of-line copy of the function will be generated in that translation unit regardless of whether compiler option `KEEPINLINES` is enabled or not.

**Note:** This does not limit the behavior for functions implicitly generated by the compiler. Implicitly declared special members such as the default constructor, copy constructor, destructor and copy assignment operator are inline and the compiler may instantiate them. In particular, out-of-line copies may be generated.

3. Degradation of the amount of inlining achieved on functions that are not "inline" and are subject to explicit instantiation declarations may occur.
4. When a non-pure virtual member function is subject to an explicit instantiation declaration, either directly or through its class, the virtual member function must be subject to an explicit instantiation definition somewhere in the entire program or an unresolved symbol error may result at link time.
5. When implicit instantiation of a class template specialization is allowed, the user program must be written as if a use requiring the implicit instantiation of all virtual member functions of that class specialization occurs or an unresolved symbol error for a virtual member function may result at link time.
6. When implicit instantiation of a class template specialization is allowed and the specialization is subject to explicit instantiation declaration, the class template specialization must be subject to an explicit instantiation definition somewhere in the user program or an unresolved symbol error may result at link time.

The following compiler options interact with explicit instantiation declarations:

<code>INLINE</code>	All functions, subject to explicit instantiation declaration or not, will be considered for inlining.
<code>TEMPINC,</code> <code>TEMPLATEREGISTRY</code>	Explicit instantiation declarations are honored. Referenced specializations that are subject to explicit instantiation declaration but not subject to explicit instantiation definition in a translation unit will not be instantiated because of that translation unit.

The following IBM language extensions interact with explicit instantiation declarations:

<code>#pragma instantiate</code>	Semantically the same as an explicit instantiation definition.
<code>#pragma do_not_instantiate</code>	This pragma provides a subset of the functionality of standard C++ explicit instantiation declarations. It is provided for backwards compatibility purposes only. New applications should use standard C++11 explicit instantiation declarations.

#pragma ishome #pragma hashome	#pragma ishome will cause generation of the virtual function table (VFT) for a class template specialization irrespective of explicit instantiation declarations of the specialization.
-----------------------------------	---

## Examples of explicit instantiation declarations

Figure 146 shows a simple and typical use of explicit instantiation declarations. The header (sample1.h) contains explicit instantiation declaration. One translation unit (sample1a.C) contains explicit instantiation definition. Another translation unit (sample1b.C) can use the specialization without having the specialization instantiated multiple times.

---

```

sample1.h:
template <typename T, T val>
union A {
T foo();
};

extern template union A<int, 55>;

template <class T, T val>
T A<T, val>::foo(void) {
return val;
}

sample1a.C:
#include "sample1.h"

template union A<int, 55>;

sample1b.C:
#include "sample1.h"

int main(void) {
return A<int, 55>().foo();
}

```

---

*Figure 146. Simple and typical use of explicit instantiation declarations*

Figure 147 on page 465 shows an erroneous case. That is, an explicit instantiation declaration of virtual member function foo() is present; but, the explicit instantiation definition of the function is not found.

---

```
sample2.C:
template <typename T, T val>
struct A {
virtual T foo();
virtual T bar();
};

extern template int A<int, 55>::foo();

template <class T, T val>
T A<T, val>::foo(void) {
return val;
}

template <class T, T val>
T A<T, val>::bar(void) {
return val;
}

int main(void) {
return A<int, 55>().bar();
}
```

---

*Figure 147. Erroneous use of explicit instantiation declarations*



---

## Chapter 32. Using environment variables

This chapter describes environment variables that affect the z/OS XL C/C++ environment. You can use environment variables to define the characteristics of a specific environment. They may be set, retrieved, and used during the execution of a z/OS XL C/C++ program.

The following environment variables affect the z/OS XL C/C++ environment if they are on when an application program runs. The variables that begin with `_EDC_` and `_CEE_` are described in detail in “Environment variables specific to the z/OS XL C/C++ library” on page 477. See “Locale source files” on page 964 for more information on the locale-related environment variables.

**Note:** The settings of these variables affect your environment even if you are using the C++ I/O stream classes. For more detailed information on I/O streaming and the Standard C++ I/O stream classes, see *Standard C++ Library Reference*. For information on environment variables used in z/OS UNIX System Services, see *z/OS UNIX System Services Command Reference* and *z/OS V2R2.0 UNIX System Services User’s Guide*.

### `_BIDIATTR`

Used to specify the attributes which will determine the way the bidirectional layout transformation takes place, as shown in the following example. If `_BIDIATTR` is not specified or contains erroneous values, the default values will be used. For a detailed description of the bidirectional layout transformation, see Chapter 66, “Bidirectional language support,” on page 1065.

```
export _BIDIATTR="@ls typeoftext=visual:implicit, orientation=ltr:ltr,
numerals=nominal:national"
```

### `_BIDION`

Used to specify if `iconv` will perform bidirectional layout transformation beside the basic main function (code page conversion). The value of this variable is either set to `TRUE` to activate the bidirectional layout transformation, or `FALSE` to prevent the bidirectional layout transformation. If this variable is not defined in the environment it defaults to `FALSE`.

### `_BPXK_AUTOCVT`

Activates or deactivates automatic text conversion of tagged UNIX file system files. The value of this environment variable is interrogated during initialization of the C `main()`, and at each pthread initialization in order to set the autoconversion state for the thread. The autoconversion state for the thread is looked at by the logical file system (LFS) when determining if automatic text conversion should be performed during read/write operations to tagged UNIX file system files.

The default autoconversion state is unset, meaning that the LFS must look to the `BPXPRMxx AUTOCVT` parameter, which is `ON`, `OFF`, or `ALL`. When set to a valid value, this environment variable overrides the `BPXPRMxx AUTOCVT` parameter.

**Restriction:** When `_BPXK_AUTOCVT` is `ON`, automatic conversion can only take place between IBM-1047 and ISO8859-1 code sets. Other CCSID

pairs are not supported for automatic text conversion. To request automatic conversion for any CCSID pairs that Unicode service supports, set `_BPXK_AUTOCVT` to `ALL`.

During `main()` initialization, the following behavior is defined for this environment variable:

#### Setting Autoconversion State for the Thread

- ON** Activates the automatic conversion of tagged files for Enhanced ASCII. This affects conversion for I/O for regular, pipe, and character special files that are tagged.
- OFF** Deactivates the automatic conversion of tagged files.
- ALL** Activates the automatic conversion of tagged files that are supported by z/OS UNICODE. This affects conversion for I/O for regular and pipe files that are tagged. If the conversion is between EBCDIC and ASCII, it also affects conversion for I/O for character special files.

#### <other>

Treated as unset. Autoconversion defers to `BPXPRMxx AUTOCVT` parameter.

Changing the value of this environment variable using `setenv()`, `putenv()`, or `clearenv()` during execution of the application will behave in the following manner:

- Ignored after the first `pthread create`, although `getenv()` might show otherwise. The autoconversion state will remain unchanged.
- Deleting or clearing the environment variable, or setting the value to an invalid value before the first `pthread create` will change the autoconversion state to unset.
- Has no effect on initially untagged UNIX file system files that have already been opened using `fopen()` or `freopen()` on the current thread and `FILETAG(AUTOCVT)` is in effect. These files were specifically marked, or not marked, for automatic text conversion, at the file descriptor level, at the time they were opened. The text conversion state for the already opened file descriptors depended on whether or not autoconversion for the thread was activated or deactivated at the time of the open.
- The standard streams may have already been setup for automatic text conversion, before the `main()` begins execution, using EBCDIC CCSID 1047 as the File CCSID. Therefore, changing the autoconversion state using one of these methods will not affect the standard streams. Specifically, an application running with ASCII CCSID 819 as the Program CCSID will continue to have text conversion with the standard streams.

Changing the value of this environment variable using any other mechanism is ignored, although `getenv()` might show otherwise. You can use `setenv()` with a value of `NULL` to delete an environment variable.

#### `_BPXK_CCSIDS`

Defines the EBCDIC<->ASCII pair of coded character set IDs (CCSIDS) to be used when converting text data, and for automatic tagging new or empty UNIX file system files. The syntax of the environment variable value is as follows, where *e* is the EBCDIC CCSID and *a* is the ASCII CCSID.

`_BPXK_CCSDS=(e,a)`

Language Environment C/C++ applications will initialize with the default IBM-1047<->ISO8859-1 pair. This is equivalent to specifying:  
`_BPXK_CCSDS=(1047,819)` before running the application.

The value of this environment variable is interrogated during initialization of the C `main()`, and at each pthread initialization in order to set the Program CCSID for the thread. For the `main()`, the Program CCSID is set to the ASCII value of the pair when the `main()` is part of an ASCII compile unit, otherwise it is set to the EBCDIC value of the pair. The Program CCSID for a thread is set based on the compiled codeset of the thread start routine. When ASCII, the ASCII value of the CCSID pair is used, else the EBCDIC value.

**Note:** Starting from z/OS V2R1, environment variable `_BPXK_PCCSID` is introduced to represent Program CCSID. The behavior of `_BPXK_CCSDS` of the existing programs will not be affected unless `_BPXK_PCCSID` is set. If both `_BPXK_CCSDS` and `_BPXK_PCCSID` are set before a program runs, `_BPXK_PCCSID` is used as the initial value of program CCSID. When a program is running, the CCSID of a thread can be affected by calling `setenv()` or `putenv()` with either of the two environment variables.

Changing the value of this environment variable using `setenv()`, `putenv()`, or `clearenv()` during execution of the application will behave in the following manner:

- Ignored after the first pthread create, although `getenv()` might show otherwise. The current CCSID pair used for conversion & tagging purposes will remain unchanged.
- Deleting or clearing the environment variable before the first pthread create will result in the default CCSID pair (1047,819) being used for conversion and tagging purposes.
- Using improper syntax before the first pthread create will result in the CCSID pair being set to (0,0). This will prevent any further conversion.
- Has no effect on initially untagged new or empty UNIX file system files that have already been opened using `fopen()`, `fropen()`, or `popen()` on the current thread and `FILETAG(AUTOTAG)` is in effect. These files were setup for tagging upon first write at the time they were opened. The File CCSID was set to what the Program CCSID was at the time of the open.
- The standard streams may have already been setup for automatic text conversion, before the `main()` begins execution, using EBCDIC CCSID 1047 as the File CCSID, therefore changing the CCSID pair using one of these methods will not affect the standard streams.

**Note:** Changing the value of this environment variable using any other mechanism is ignored, although `getenv()` might show otherwise. You can use `setenv()` with a value of `NULL` to delete an environment variable.

## `_BPXK_PCCSID`

Identifies the program CCSID for the running thread or user. It can be used to override the internal default of 1047 (EBCDIC). Any value between 0 and 65535 can be assigned. However, to avoid any subsequent errors, only values that are supported by Unicode Services can be used. Setting or unsetting this variable has no effect when translation for a file has started. When unset, the internal value of the program CCSID reverts back to the default of 1047.



## \_BPXK\_SIGDANGER

Set to either YES or NO, this variable modifies the process termination mechanism used during UNIX System Services Shutdown. During Shutdown the kernel sends a signal to each non-permanent non-blocking process. If \_BPXK\_SIGDANGER is not in the environment, or if its value is not YES, then SIGTERM is sent to these processes. If \_BPXK\_SIGDANGER is present in the environment and has the value YES then signal SIGDANGER will be sent instead of SIGTERM. The default action for SIGTERM is to terminate the process, but the default action for SIGDANGER is to ignore the signal. The application may register a SIGDANGER signal catcher function to handle shutdowns. If the process does not end in a short while after being sent the first signal, the kernel will send SIGKILL to the process. If the process does not end in a short while after the second signal is sent, the process will be brought down using CALLRTM ABTERM=YES.

**Note:** The program should not use the environ external variable to put this or any other "\_BPXK\_" environment variable into its own environment. The Kernel will not be told about the environment variable setting when it is added to the environment this way. The program should use an environ pointer to put this variable into the environment of a new process created with spawn() or exec(). In this case the kernel will notice \_BPXK\_ environment variables being created for a new program image. In addition, the kernel will correctly detect \_BPXK\_ environment variables generated into child processes created via fork() and spawn().

## \_CEE\_DLLLOAD\_XPCOMPAT

Used to indicate whether certain 31 bit XPLINK DLL application initialization compatibility behaviors should be disabled.

## \_CEE\_DMPTARG

Used to specify the directory in which Language Environment dumps (CEEDUMPs) are written for applications that are running as the result of a fork, exec, or spawn. This environment variable is ignored if the application is not run as a result of a fork, exec, or spawn. Additionally \_CEE\_DMPTARG can be used to direct the CEEDUMPs output to a specific sysout class.

## \_CEE\_ENVFILE

Used to specify a file from which to read environment variables.

## \_CEE\_ENVFILE\_COMMENT

Used to define the comment character to be checked for when z/OS XL C/C++ reads subsequent records from the file.

## \_CEE\_ENVFILE\_CONTINUATION

Used to define the continuation character to be checked for when z/OS XL C/C++ reads subsequent records from the file.

## \_CEE\_ENVFILE\_S

Used to specify a file from which to read environment variables, stripping trailing white space from each NAME=VALUE line read.

## \_CEE\_HEAP\_MANAGER

Used to specify the DLL name for the Vendor Heap Manager to be used during execution of the application.

## \_CEE\_REALLOC\_CONTROL

Used to specify the lower bound for the tolerance percentage to be applied

and specify the percentage that the storage request will be increased if the request is greater than or equal to the lower bound specified.

#### **\_CEE\_RUNOPTS**

Used to specify Language Environment runtime options to a program invoked by using one of the exec functions, such as a program which is invoked from one of the z/OS UNIX shells.

#### **\_EDC\_ADD\_ERRNO2**

Appends errno2 information to the output of perror() and strerror().

#### **\_EDC\_ANSI\_OPEN\_DEFAULT**

Affects the characteristics of MVS text files opened with the default attributes.

#### **\_EDC\_AUTOCVT\_BINARY**

If automatic file conversion is enabled ( \_BPXK\_AUTOCVT=ON and running with FILETAG(AUTOCVT) runtime option), this environment variable activates or deactivates automatic conversion of untagged UNIX file system files opened in binary mode and not opened for record I/O.

#### **\_EDC\_BYTE\_SEEK**

Specifies that fseek() and ftell() should use relative byte offsets.

#### **\_EDC\_CLEAR\_SCREEN**

Affects the behavior of output text terminal files.

#### **\_EDC\_COMPAT**

Specifies that C/C++ should use specific functional behavior from previous releases of C/370.

#### **\_EDC\_CONTEXT\_GUARD**

Allows the user to control the method used to handle the guard page for AMODE 64 user context stacks.

#### **\_EDC\_C99\_NAN**

Sets the binary floating-point representation behavior of infinite value and Not a Number for the printf family of functions

#### **\_EDC\_DLL\_DIAG**

Indicates if additional DLL diagnostic information should be generated upon failure for the following DLL functions: dllload(), dlopen(), dllqueryfn(), dllqueryvar(), dlsym(), dllfree(), and dlclose() .

\_EDC\_DLL\_DIAG has no effect on implicit DLLs. If \_EDC\_DLL\_DIAG is not set by the user, it will default to QUIET.

#### **\_EDC\_EOVERFLOW**

Sets the behavior of the ftell(), fseek(), fstat(), lstat(), stat(), and mmap() functions. By default these functions will not check for the EOVERFLOW error condition. Setting \_EDC\_EOVERFLOW to YES enables testing for this condition, and, if overflow is detected, setting errno to EOVERFLOW and returning an error.

#### **\_EDC\_ERRNO\_DIAG**

Indicates if additional diagnostic information should be generated, when the perror() or strerror() functions are called to produce an error message.

#### **\_EDC\_FLUSH\_STDOUT\_PIPE**

Flushes the stdout stream when the stdin stream is being read. Both stdin and stdout must be pipes.

#### **\_EDC\_FLUSH\_STDOUT\_SOCKET**

Flushes the stdout stream when the stdin stream is being read. Both stdin and stdout must be sockets.

#### **\_EDC\_GLOBAL\_STREAMS**

Allows the C standard streams stdin, stdout and stderr to have global behavior. `_EDC_GLOBAL_STREAMS` is not supported in AMODE 64.

#### **\_EDC\_IEEEV1\_COMPATIBILITY\_ENV**

Used to access original versions of the fdlibm functions when the value of `_EDC_IEEEV1_COMPATIBILITY_ENV` is set to ON.

#### **\_EDC\_IO\_ABEND**

Controls if the runtime library should attempt to recover from an abend issued during OS I/O processing.

#### **\_EDC\_IO\_TRACE**

Indicates which files to perform file I/O tracing on, the level of detail to provide for file I/O tracing, and the trace buffer size to use for each file.

#### **\_EDC\_POPEN**

Specifies that `popen()` uses `spawn()` instead of `fork()`.

#### **\_EDC\_PTHREAD\_YIELD**

Used to control when `pthread_yield()` and `sched_yield()` will allow a thread to give up control of a processor so that another thread may have the opportunity to run.

#### **\_EDC\_PTHREAD\_YIELD\_MAX**

Allows a user program to define the max yield (wait) time for a particular thread.

#### **\_EDC\_PUTENV\_COPY**

Copies the `putenv()` string into storage owned by Language Environment.

#### **\_EDC\_RRDS\_HIDE\_KEY**

Relevant for VSAM RRDS files opened in record mode. Enables calls to `fread()` that specify a pointer to a character string and do not append the Relative Record Number to the beginning of the string.

#### **\_EDC\_STOR\_INCREMENT**

Sets the size of increments to the internal library storage subpool acquired above the 16M line. `_EDC_STOR_INCREMENT` is not supported in AMODE 64 applications. In AMODE 64 applications, this environment variable is replaced by the IOHEAP64 runtime option.

#### **\_EDC\_STOR\_INCREMENT\_B**

Sets the size of increments to the internal library storage subpool acquired below the 16M line. `_EDC_STOR_INCREMENT_B` is not supported in AMODE 64 applications. In AMODE 64 applications, this environment variable is replaced by the IOHEAP64 runtime option.

#### **\_EDC\_STOR\_INITIAL**

Sets the initial size of the internal library storage subpool acquired above the 16M line. `_EDC_STOR_INITIAL` is not supported in AMODE 64 applications. In AMODE 64 applications, this environment variable is replaced by the IOHEAP64 runtime option.

#### **\_EDC\_STOR\_INITIAL\_B**

Sets the initial size of the internal library storage subpool acquired below the 16M line. `_EDC_STOR_INITIAL_B` is not supported in AMODE 64

applications. In AMODE 64 applications, this environment variable is replaced by the IOHEAP64 runtime option.

#### **\_EDC\_STRPTM\_STD**

Indicates changes to `strptime()` that are provided for UNIX standard compliance.

#### **\_EDC\_SUSV3**

Indicates behavioral changes that are provided for SUSV3 compliance in an error path. The affected interfaces are typically setting *errno* to values that were not used before and, in some cases, returning failure for conditions that had not been tested before SUSV3. By default the affected interfaces will not check for these conditions. When the value of `_EDC_SUSV3` is set to 1, the SUSV3 behavior is enabled. When the value of `_EDC_SUSV3` is set to 2, all the behaviors protected by `_EDC_SUSV3=1` are exposed, and pole error related behaviors specified by SUSV3 will be enabled.

#### **\_EDC\_UMASK\_DFLT**

Allows the user to control how the C library sets the default umask used when the program runs.

#### **\_EDC\_ZERO\_RECLEN**

Enables processing of zero-length records in an MVS data set opened in variable format.

#### **\_ICONV\_MODE**

Selects the behavior mode for `iconv_open()`, `iconv()`, and `iconv_close()` family of functions.

#### **\_ICONV\_TECHNIQUE**

Determines the conversion technique used by Unicode Conversion Services. For more information regarding the Unicode conversion Services value, see *z/OS Unicode Services User's Guide and Reference*.

#### **\_ICONV\_UCS2**

Tells `iconv_open(Y, X)` what type of conversion method to setup when there is a choice between "direct" conversion from X to Y and "indirect" X to UCS-2 to Y. This variable is ignored when using Unicode Conversion Services.

#### **\_ICONV\_UCS2\_PREFIX**

Tells `iconv_open()` what z/OS dataset name prefix to use to find UCS-2 tables if they cannot be found in the HFS. This variable is ignored when using Unicode Conversion Services.

#### **LANG**

Determines the locale to use for the locale categories when neither the `LC_ALL` environment variable nor the individual locale environment variables specify locale information. This environment variable does not interact with the language setting for messages.

#### **LC\_ALL**

Determine the locale to be used to override any values for locale categories specified by the settings of the `LANG` environment variable or any individual locale environment variables.

#### **LC\_COLLATE**

Determines the behavior of ranges, equivalence classes, and multicharacter collating elements.

**LC\_CTYPE**

Determines the locale for the interpretation of byte sequences of text data as characters (for example, single-byte versus multibyte characters in arguments and input files).

**LC\_MESSAGES**

Determines the language in which messages are to be written.

**LC\_MONETARY**

Determines the locale category for monetary-related numeric formatting information.

**LC\_NUMERIC**

Determines the locale category for numeric formatting (for example, thousands separator and radix character) information.

**LC\_TIME**

Determines the locale category for date and time formatting information.

**LC\_TOD**

Determines the locale category for time of day and Daylight Savings Time formatting information.

**LIBPATH**

Allows an absolute or relative pathname to be searched when loading a DLL. If the input filename contains a slash (/), it is used as is to locate the DLL. If the input filename does not contain a slash, then LIBPATH is used to determine the pathname to load. LIBPATH specifies a list of directories separated by colons. If the LIBPATH begins or ends with a colon, then the working directory is also searched first or last, depending on the position of the stand-alone colon. The ":" specification can only occur at the beginning or end of the list of directories. If you are running POSIX(ON), then UNIX file system is searched first followed by MVS. If you are running POSIX(OFF), then MVS is searched first followed by UNIX file system. This double search can be avoided by using unambiguous DLL names.

**LOCPATH**

Tells the `setlocale()` function the name of the directory in the UNIX file system from which to load the locale object files. It specifies a colon separated list of UNIX file system directories.

If LOCPATH is defined, `setlocale()` searches UNIX file system directories in the order specified by LOCPATH for locale object files it requires. Locale object files in the UNIX file system are produced by the `localedef` utility running under z/OS UNIX.

If LOCPATH is not defined and `setlocale()` is called by a POSIX program, `setlocale()` looks in the default UNIX file system locale directory, `/usr/lib/nls/locale`, for locale object files it requires. If `setlocale()` does not find a locale object it requires in the UNIX file system, it converts the locale name to a PDS member name and searches locale PDS load libraries associated with the program calling `setlocale()`.

**Note:** XPLINK locales have an `.xplink` suffix added to the end of the locale name. For more information about XPLINK locale names, see "Locale naming conventions" on page 994

**PATH** The set of UNIX file system directories that some z/OS XL C/C++ functions, such as EXECVP, use in trying to locate an executable. The

directories are separated by a colon (:) delimiter. If the pathname contains a slash, the PATH environment variable will not be used.

### **\_\_POSIX\_SYSTEM**

Determines the behavior of the `system()` function when the `POSIX(ON)` runtime option has been specified. If `__POSIX_SYSTEM=NO`, then `system()` behaves as in Language Environment/370 1.2: it creates a nested enclave within the same process as the invoker (allowing such things as sharing of memory files). Otherwise, `system()` performs a `fork()` and `exec()`, and the target program runs in a separate process (preventing such things as sharing of memory files).

**Restriction:** `__POSIX_SYSTEM=NO` is not supported in AMODE 64 applications.

### **\_\_POSIX\_TMPNAM**

Determines the behavior of the `tmpnam()` function when the `POSIX(ON)` runtime option has been specified. If the `__POSIX_TMPNAM` environment variable is set to `NO`, `tmpnam()` behaves as if it was called under `POSIX(OFF)`. Otherwise, `tmpnam()` generates a unique file name in the UNIX file system.

### **STEPLIB**

Determines the STEPLIB environment that is created for an executable file. It can be a sequence of MVS data set names separated by a colon (:), or can contain the value `CURRENT` or `NONE`. If you do not want a STEPLIB environment propagated to the environment of the executable file, specify `NONE`. The STEPLIB environment variable defaults to the value `CURRENT`, which will propagate your current environment to that of the executable file. See *z/OS UNIX System Services Command Reference* for more information on the use of the STEPLIB variable and changing the search order for z/OS programs.

### **TZ or \_TZ**

Time zone information. The `TZ` and `_TZ` environment variables are typically set when you start a shell session, either through `/etc/profile` or `.profile` in your home directory. For more information, see Chapter 62, "Customizing a time zone," on page 1013.

---

## **Working with environment variables**

The following library functions affect environment variables:

- `setenv()`
- `clearenv()`
- `getenv()`
- `__getenv()`
- `putenv()`
- `unsetenv()`

The `setenv()` function adds, changes, and deletes environment variables in the environment variable table. The `getenv()` function retrieves the values from the table. If it does not find an environment variable, `getenv()` returns `NULL`. The `clearenv()` function clears the environment variable table, and resets to default behavior the actions affected by z/OS XL C/C++-specific environment variables. The `unsetenv()` function deletes environment variables from the table.

The `__getenv()` function behaves almost the same as `getenv()` except `getenv()` returns the address of the environment variable value string that has been copied into a buffer, whereas `__getenv()` returns the address of the actual value string in the environment variable array. Because the value is not buffered, `__getenv()` cannot be used in a multithreaded application or in a single threaded application where the function `setenv()` changes the value of the variables.

The `putenv()` function provides a subset of the function of `setenv()` and is provided for convenience in porting UNIX applications. `putenv(env_var)` is the same as `setenv(var_name, var_value, i)` where `env_var` represents the string `var_name=var_value`.

For a complete description of these functions, refer to *z/OS XL C/C++ Runtime Library Reference*.

Environment variables may be set any time in an application program or user exit. You can use the exit routine `CEEEXIT` to set environment variables through calls to `setenv()`. For more information on the z/OS Language Environment user exit `CEEEXIT`, refer to "Using runtime user exits in z/OS Language Environment" on page 837. You can also set environment variables by using the `ENVAR` runtime option. The syntax for this option is as follows:

```
ENVAR("1st_var=1st_value", "2nd_var=2nd_value")
```

For more information on this runtime option, refer to *z/OS Language Environment Programming Reference*.

Specifying the `_CEE_ENVFILE` or `_CEE_ENVFILE_S` environment variable with a filename on the `ENVAR` option enables you to read more environment variables from that file. See "Environment variables specific to the z/OS XL C/C++ library" on page 477 for more information about `_CEE_ENVFILE` and `_CEE_ENVFILE_S`.

Environment variables set with the `setenv()` function exist only for the life of the program, and are not saved before program termination. Child programs are initialized with the environment variables of the parent. However, environment variables set by a child program are not propagated back to the parent upon termination of the child program.

**Note:** If you are running with `POSIX(ON)`, environment variables are copied from a parent process to a child process when a `fork()` function is called, and are inherited by the new process image when an `EXEC` function is called.

When a parent process invokes a child process by using `system()`, using the ANSI form of the system function, the child receives its environment variables from the value of the `ENVAR` runtime option specified on the invocation of `system()`. For example:

```
system("PGM=CHILD, PARM='ENVAR(ABC=5)'/");)
```

## Naming conventions

Avoid the following when creating names for environment variables:

= Not valid and will generate an error message.

`_CBC_`

Reserved for z/OS XL C/C++ specific environment variables.

`_CCN_`

Reserved for z/OS XL C/C++ specific environment variables.



### **`_EDC_`**

Reserved for z/OS XL C/C++ specific environment variables.

### **`_CEE_`**

Reserved for z/OS XL C/C++ specific environment variables used with z/OS Language Environment. See “Environment variables specific to the z/OS XL C/C++ library” for more information.

### **`_BPX_`**

Reserved for z/OS XL C/C++ specific environment variables used in the kernel. See the spawn callable service in *z/OS UNIX System Services Programming: Assembler Callable Services Reference* for more information.

### **DBCS characters**

Multibyte and DBCS characters should not be used in environment variable names. Their use can result in unpredictable behavior. Multibyte and DBCS characters are allowed in environment variable values; however, the values are not validated, and redundant shifts are not removed.

### **white space**

Blank spaces are valid characters and should be used carefully in environment variable names and values. For example, `setenv(" my name"," David ",1)` sets the environment variable `<space>my<space>name` to `<space><space>David`. A call to `getenv("my name")`; returns `NULL` indicating that the variable was not found. You must specifically query `getenv(" my name")` to retrieve the value of `" David"`.

The environment variable names are case-sensitive. The empty string is a valid environment variable name.

**Note:** In general, it is a good idea to avoid special characters, and to use portable names containing just upper and lower case alphabetic, numeric, and underscore characters. Environment variable names containing certain special characters, such as slash (/), are not propagated by the z/OS UNIX shells. Therefore, these variable names are not available to a program called using the `POSIX system()` function.

---

## **Environment variables specific to the z/OS XL C/C++ library**

The following z/OS XL C/C++ specific environment variables are supported to provide various functions. z/OS XL C/C++ variables have the prefix `_CEE_` or `_EDC_`. You should not use these prefixes to name your own variables.

- `_CEE_DLLLOAD_XPCOMPAT`
- `_CEE_DMPTARG`
- `_CEE_ENVFILE`
- `_CEE_ENVFILE_COMMENT`
- `_CEE_ENVFILE_CONTINUATION`
- `_CEE_ENVFILE_S`
- `_CEE_HEAP_MANAGER`
- `_CEE_REALLOC_CONTROL`
- `_CEE_RUNOPTS`
- `_EDC_ADD_ERRNO2`
- `_EDC_ANSI_OPEN_DEFAULT`
- `_EDC_AUTOCVT_BINARY`
- `_EDC_BYTE_SEEK`
- `_EDC_CLEAR_SCREEN`
- `_EDC_COMPAT`



- `_EDC_CONTEXT_GUARD`
- `_EDC_C99_NAN`
- `_EDC_DLL_DIAG`
- `_EDC_EOVERFLOW`
- `_EDC_ERRNO_DIAG`
- `_EDC_FLUSH_STDOUT_PIPE`
- `_EDC_FLUSH_STDOUT_SOCKET`
- `_EDC_GLOBAL_STREAMS`
- `_EDC_IEEEV1_COMPATIBILITY_ENV`
- `_EDC_IO_ABEND`
- `_EDC_IO_TRACE`
- `_EDC_POPEN`
- `_EDC_PTHREAD_YIELD`
- `_EDC_PTHREAD_YIELD_MAX`
- `_EDC_PUTENV_COPY`
- `_EDC_RRDS_HIDE_KEY`
- `_EDC_STOR_INCREMENT`
- `_EDC_STOR_INCREMENT_B`
- `_EDC_STOR_INITIAL`
- `_EDC_STOR_INITIAL_B`
- `_EDC_STRPTM_STD`
- `_EDC_SUSV3`
- `_EDC_UMASK_DFLT`
- `_EDC_ZERO_RECLEN`

There are no default settings for the environment variables that begin with `_EDC_`. There are, however, default *actions* that occur if these environment variables are undefined or are set to invalid values. See the descriptions of each variable below.

The z/OS XL C/C++ specific environment variables may be set with the `setenv()` function.

## **`_CEE_DLLLOAD_XPCOMPAT`**

Used to indicate if certain 31-bit XPLINK DLL application initialization compatibility behaviors should be disabled.

This environment variable should only be used for applications that do not run properly when migrating from one release to another. While the correct runtime behavior is in the current release, this environment variable provides compatibility support for existing programs. The need to use these settings indicates incorrect programming within the application (for example, reliance on a particular order of C++ static construction across all DLLs that comprise the application). When possible, you should correct the application rather than use this environment variable.

- |          |  |
|----------|--|
| <b>0</b> | Always the most current behavior (e.g. no compatibility behavior enabled). This is identical to the behavior when <code>_CEE_DLLLOAD_XPCOMPAT</code> is not set. |
| <b>1</b> | Disable static initialization prerequisite XPLINK DLL load ordering introduced in z/OS V1R6.   |

- 2 Disable non-XPLINK to XPLINK DLL function pointer compatibility introduced in z/OS V1R8.
- 3 Disable both static initialization prerequisite XPLINK DLL load ordering, and non-XPLINK to XPLINK DLL function pointer compatibility. (Disables both behaviors 1 and 2.)

z/OS Language Environment converts the specified string value to a signed integer, and interprets this value as a bit mask to determine which functions to use in compatibility mode. This allows any combination of compatibility behaviors to be specified.

Here are some examples of how you might set this environment variable:

- z/OS UNIX: `export _CEE_DLLLOAD_XPCOMPAT=1` Disable behavior 1
- Batch/TSO command line: `ENVAR("_CEE_DLLLOAD_XPCOMPAT=3")` Disable behaviors 1 and 2

**Note:** Any change to the `_CEE_DLLLOAD_XPCOMPAT` environment variable after the application enclave has already been initialized, will not have any effect on the current application enclave.

For information about XPLINK function pointer compatibility see "XPLINK applications" on page 302.

## **`_CEE_DMPTARG`**

You can use this variable in two ways:

1. To specify the directory in which Language Environment dumps (CEEDUMPs) are written for applications that are running as the result of a fork, exec, or spawn.

This environment variable is ignored if the application is not run as a result of a fork, exec, or spawn. When `_CEE_DMPTARG` is set in one of these environments, its value is used as the directory name in which to place CEEDUMPs.

- If in a shell, you set the environment variable as follows. Language Environment dumps will be written to directory `/u/userid/dmpdir`.

```
export _CEE_DMPTARG=/u/userid/dmpdir
```

- If in a shell, you set the environment variable as follows. In this case, Language Environment dumps will be written to directory `"cwd"/dmpdir`, where `"cwd"` is the current working directory.

```
export _CEE_DMPTARG=dmpdir
```

2. To direct the CEEDUMPs output to a specific sysout class.

When Language Environment dumps (CEEDUMPS) are produced as a result of running a job, by default they will be written to the default sysout class. You can use `_CEE_DMPTARG` to direct the CEEDUMPS output to a specific sysout class by using this environment variable as follows, where `xis` is the output class.

```
_CEE_DMPTARG=SYSOUT(x)
```

You can also use the CEEDUMP runtime option to specify a sysout class for dynamically allocated Language environment dump reports. In addition to a sysout class, this runtime option allows you to specify a form-name. See *z/OS Language Environment Programming Reference* for further information about the CEEDUMP runtime option."

See *z/OS Language Environment Debugging Guide* and *z/OS V2R1.0 Language Environment Programming Guide for 64-bit Virtual Addressing Mode* for additional information about `_CEE_DMPTARG`.

## `_CEE_ENVFILE`

Enables a list of environment variables to be set from a specified file. This environment variable only takes effect when it is set through the runtime option `ENVAR` on initialization of a parent program. When `_CEE_ENVFILE` is defined under these conditions, its value is taken as the name of the file to be used. For example, to read the ddname `MYVARS`, you would call your program with the `ENVAR` runtime option, as follows:

```
ENVAR("_CEE_ENVFILE=DD:MYVARS")
```

When you set the environment variables with a file in the UNIX file system, you need to use the absolute path to specify the file. For example, if the absolute path of the file is `/u/DPGROSS/octest/tsthe11o/ENV`, you would call your program with the `ENVAR` runtime option as follows:

```
ENVAR("_CEE_ENVFILE=/u/DPGROSS/octest/tsthe11o/ENV")
```

The specified file is opened as a variable length record file. For an MVS data set, the data set must be allocated with `RECFM=V`. `RECFM=VBS` must not be used because environment variables may not be contained in spanned records. `RECFM=F` is not suggested because `RECFM=F` enables padding with blanks, and the blanks are counted when calculating the size of the line. Each record consists of `NAME=VALUE`. For example, a file with the following two records:

```
_EDC_RRDS_HIDE_KEY=Y  
World_Champions=New_York_Yankees
```

would set the environment variable `_EDC_RRDS_HIDE_KEY` to the value `Y`, and the environment variable `World_Champions` to the value `New_York_Yankees`.

### Notes:

1. Using `_CEE_ENVFILE` to set environment variables through a file is not supported under CICS.
2. *z/OS Language Environment* searches for an equal sign to delimit the environment variable from its value. If an equal sign is not found, the environment variable is skipped and the rest of the text is treated as comments.
3. Each record of the file is processed independently from any other record in the file. Data within a record is used exactly as input with no substitution. A file containing:

```
FRED=WILMA  
FRED=$FRED:BAMBAM
```

will result in the environment variable `FRED` being set to `$FRED:BAMBAM`, rather than to `WILMA:BAMBAM` as would be the case if the same statements were processed by a UNIX shell.

## `_CEE_ENVFILE_COMMENT`

Defines the comment character to be checked for when subsequent records are read from the file. `_CEE_ENVFILE_COMMENT` is defined within the file specified by the `_CEE_ENVFILE` or `_CEE_ENVFILE_S` environment variable. The comment character used is the first character after the `=` and it must not be a space character, as determined by the `isspace()` macro.

In the following example, the comment character is defined as \*. With this in place, any subsequent line that begins with \* in column one is treated as a comment and processing will skip to the next line.

```
_CEE_ENVFILE_COMMENT=*
* This is a comment
NAME1=VALUE1
```

**Notes:**

1. Comments cannot be placed within a set of continuation lines.
2. If `_CEE_ENVFILE_COMMENT` is encountered when the file is read, it is only used to define the comment character; the keyword is not added to the environment.

## **`_CEE_ENVFILE_CONTINUATION`**

Defines the continuation character to be checked for when subsequent records are read from the file. `_CEE_ENVFILE_CONTINUATION` is defined within the file specified by the `_CEE_ENVFILE` or `_CEE_ENVFILE_S` environment variable. The continuation character used is the first character after the = and it must not be a space character, as determined by the `isspace()` macro.

When a continuation character is defined and a name=value sequence is found, where the last non-whitespace character matches the continuation character, the next line of the file is read and appended to value. If the last non-whitespace character of the updated value matches the continuation character, the next line of the file is read and appended to value. This continues until the last non-whitespace character does not match the continuation character and then the name and value pair are set into the environment.

In the following example, the continuation character is defined as \. With this in place, the STEPLIB keyword defined on the next line is defined to have a value that spans multiple lines. When queried by the application, the value of STEPLIB is CEE.SCEERUN2:CEE.SCEERUN:MY.LOADLIB.

```
_CEE_ENVFILE_CONTINUATION=\
STEPLIB=CEE.SCEERUN2:\
CEE.SCEERUN:\
MY.LOADLIB
```

**Notes:**

1. If `_CEE_ENVFILE_CONTINUATION` is encountered when the file is read, it is only used to define the continuation character; `_CEE_ENVFILE_CONTINUATION` is not added to the environment.
2. The name= portion of the name=value sequence cannot exceed one line.
3. The length of the value is limited only by the memory available to read, concatenate the lines, and set the variable into the environment.

## **`_CEE_ENVFILE_S`**

Enables a list of environment variables to be set from a specified file, stripping trailing white space from each NAME=VALUE line read.. This environment variable only takes effect when it is set through the runtime option ENVAR on initialization of a parent program.

When `_CEE_ENVFILE_S` is defined under this condition, its value specifies the name of the file to be used. For example, to read the ddname MYVARS, you would call your program with the ENVAR runtime option as follows:

```
ENVAR("_CEE_ENVFILE_S=DD:MYVARS")
```

When you set the environment variables with a file in the UNIX file system, you need to use the absolute path to specify the file. For example, if the absolute path of the file is `/u/DPGROSS/ootest/tsthello/ENV`, you would call your program with the `ENVAR` runtime option as follows:

```
ENVAR("_CEE_ENVFILE_S=/u/DPGROSS/ootest/tsthello/ENV")
```

For an MVS data set, the data set can be allocated with any record format except `RECFM=VBS`, because environment variables may not be contained in spanned records. Each record consists of `NAME=VALUE`. For example, a file with the following two records:

```
_EDC_RRDS_HIDE_KEY=Y
World_Champions=New_York_Yankees
```

would set the environment variable `_EDC_RRDS_HIDE_KEY` to the value `Y`, and the environment variable `World_Champions` to the value `New_York_Yankees`.

**Notes:**

1. Using `_CEE_ENVFILE_S` to set environment variables through a file is not supported under CICS.
2. z/OS Language Environment searches for an equal sign to delimit the environment variable from its value. If an equal sign is not found, the environment variable is skipped and the rest of the text is treated as comments.
3. Both environment variables `_CEE_ENVFILE` and `_CEE_ENVFILE_S` can be specified. `_CEE_ENVFILE_S` takes precedence, meaning it is processed second in sequence.
4. Each record of the file is processed independently from any other record in the file. Data within a record is used exactly as input with no substitution (other than trailing white space is ignored). A file containing:

```
FRED=WILMA
FRED=$FRED:BAMBAM
```

will result in the environment variable `FRED` being set to `$FRED:BAMBAM`, rather than to `WILMA:BAMBAM` as would be the case if the same statements were processed by a UNIX shell.

## **`_CEE_HEAP_MANAGER`**

Specifies the name of the Vendor Heap Manager (VHM) DLL that will be used to manage the user heap. You set the environment variable as follows:

```
_CEE_HEAP_MANAGER=dllname
```

This environment variable must be set using one of the following mechanisms:

- `ENVAR` runtime option
- Inside the file specified by the `_CEE_ENVFILE` or `_CEE_ENVFILE_S` environment variable.

Either of these mechanisms is before any user code gets control. This means prior to the HLL user exit, static constructors, and/or main getting control. Setting of this environment variable once the user code has begun execution will not activate the VHM, but the value of the environment variable will be updated.

See *z/OS Language Environment Vendor Interfaces* for more information on the Vendor Heap Manager support.

## **\_CEE\_REALLOC\_CONTROL**

`_CEE_REALLOC_CONTROL` has two parameters. The first parameter specifies the lower bound for the tolerance percentage to be applied. This variable reflects the number of bytes that will cause the `realloc()` control feature to be activated. For instance, if an application issues a `malloc()` to request storage and a subsequent `realloc()` to change the size of that storage allocation, this parameter determines whether the request will be increased - with the intent that subsequent reallocations will not require additional storage be obtained and data copied.

The second parameter specifies the percentage that the storage request will be increased if the request is greater than or equal to the lower bound specified in the first parameter.

The format of the environment variable is:

```
_CEE_REALLOC_CONTROL=bound,percentage
```

**bound** *a*, *aK*, *ak*, in which *a* is an integer.

**percentage**

*p*, which is an integer between 0 and 100. The default value is 0, which means that this feature is not in use.

Attempting to reallocate storage to a new size of near 2GB while this environment variable is set may cause `realloc()` to report that a negative new size was provided as input.

**Note:** The following examples use storage sizes that are for illustration purposes only. The sizes are examples and do not reflect any storage rounding that might occur.

The following example shows this control feature being used within a loop and how an allocation of a new storage element can be eliminated:

```
_CEE_REALLOC_CONTROL=100,20
/* an example in C*/
char * buffer;
size_t buffsize;
int i;
buffsize = 100;
buffer = malloc(buffsize);

for ( i = 0; i <= 2; ++i ) {
buffsize += 10;
buffer = realloc(buffer,buffsize);
}

for ( i = 0; i <= 2; ++i ) {
buffsize -= 10;
buffer = realloc(buffer,buffsize);
}
```

Because the `realloc()` request is greater than the lower bound, the first pass through the first loop results in a new buffer with the same contents as before but within a storage element of size 132 ( $110+(110*.20)$ ) and `buffsize=110`. All the data in the first buffer (100 bytes) is copied to the second (new) buffer.

The second and third pass through the first loop issue the same `realloc`, but result in no action being taken because the new `buffsize` of 120 and then 130 allows the requested storage to remain within the current allocation of 132 bytes, even if both

requests are greater than the lower bound. Therefore, allocation of new storage elements and copies of data are eliminated.

Additionally, the first two paths through the second loop also result in no action because they result in a `buffsize` less than the current allocation and can also fit within the current allocation.

The last path through the second loop results in a new buffer of `buffsize 100`. Although this request is also less than the current allocation and fits in the current allocation, the assumption is that no tolerance ever occurred because the requested size plus the increase have resulted in a storage allocation less than the current allocation.

In other words, if `realloc` control feature is relevant (the requested storage allocation is greater than the lower bound), the rules are:

- If the (`realloc`) request is equal to the current allocation, use the same buffer location and size (do nothing).
- If the request is greater than the current allocation, get a new buffer of size (`request + tolerance`).
- If the request is lower than the current allocation and the current allocation is greater than (`request + tolerance`), assume tolerance never applied before and get a new buffer of size requested
- If the request is lower than the current allocation and the current allocation is not greater than (`request + tolerance`), use the same buffer and size (do nothing)

## **`_CEE_RUNOPTS`**

Used to specify invocation Language Environment runtime options for programs invoked using one of the `exec` family of functions. Mechanisms for setting the value of the `_CEE_RUNOPTS` environment variable include using the `export` command within the z/OS UNIX shell, or using the `setenv()` or `putenv()` functions within a C/C++ application. The runtime options set from the `_CEE_RUNOPTS` environment variable value that become active in the invoked program are known as *invocation command* runtime options.

**Note:** For this description, the `exec` family of functions includes the `spawn` family of functions.

The format of the environment variable is as follows, where `value` is a null-terminated character string of Language Environment runtime options.

```
_CEE_RUNOPTS=value
```

For example, you could specify the following to set the value of the environment variable within the z/OS UNIX shell.

```
export _CEE_RUNOPTS="stack(,,any,) termthdact(dump)"
```

The `_CEE_RUNOPTS` environment variable has a unique behavior. It can be unset, or modified, but will be re-created or added to across an `exec` to effect the propagation of invocation Language Environment runtime options. This behavior is designed specifically to allow runtime options such as `TRACE` to take effect for parts of an application which are not invoked directly by the user. Without this behavior, the external `TRACE` option could not be propagated to parts of an application that are executed using one of the `exec` family of functions.



At the time of the exec, any active invocation command runtime option settings, not already explicitly part of the `_CEE_RUNOPTS` environment variable, are added to its value. This new value for the `_CEE_RUNOPTS` environment variable is passed to the exec target to be used as invocation Language Environment runtime options for the invoked program. Thus, all invocation runtime options, those specified with the `_CEE_RUNOPTS` environment variable and those already active, are propagated across the exec.

When the `_CEE_RUNOPTS` environment variable is not defined at the time of the exec, but there are other active invocation command runtime options, it will be re-created with its value set to represent the active invocation command runtime option settings. This unique behavior, where the `_CEE_RUNOPTS` environment variable is added to, or re-created, across an exec, can cause unexpected results when the user attempts to unset (clear) the environment variable, or modify its value.

Figure 148 demonstrates this behavior. We enter the z/OS UNIX shell through OMVS, and a sub-shell is created using one of the exec family of functions. The propagation of the `_CEE_RUNOPTS` environment variable takes place across creation of the sub-shell.

---

```

/u/carbone>echo $_CEE_RUNOPTS
POSIX(ON) 1
/u/carbone>/bin/sh 2
/u/carbone>echo $_CEE_RUNOPTS 3
POSIX(ON)
/u/carbone>unset _CEE_RUNOPTS 4
/u/carbone>echo $_CEE_RUNOPTS

/u/carbone>env | grep _CEE_RUN 5
_CEE_RUNOPTS=POS(ON)
/u/carbone>echo $_CEE_RUNOPTS 6

/u/carbone>export _CEE_RUNOPTS="ABTERMENC(RETCODE)" 7
/u/carbone>echo $_CEE_RUNOPTS
ABTERMENC(RETCODE)
/u/carbone>env | grep _CEE_RUN 8
_CEE_RUNOPTS=ABTERMENC(RETCODE) POSIX(ON)
/u/carbone>/bin/sh 9
/u/carbone>echo $_CEE_RUNOPTS
ABTERMENC(RETCODE) POSIX(ON)
/u/carbone>unset _CEE_RUNOPTS
/u/carbone>echo $_CEE_RUNOPTS

/u/carbone>env | grep _CEE_RUN
_CEE_RUNOPTS=ABT(RETCODE) POSIX(ON)
/u/carbone>

```

---

Figure 148. `_CEE_RUNOPTS` behaviour

**Notes:**

1. The current value of the `_CEE_RUNOPTS` environment variable happens to be `POSIX(ON)`.
2. Using `/bin/sh` to create a sub-shell will go through the process where the `_CEE_RUNOPTS` environment variable is added to, or re-created, across the exec.
3. Displaying the value of the `_CEE_RUNOPTS` environment variable using `echo` in the sub-shell shows that no other invocation command runtime options were in effect at the time of the exec, since the value of the environment variable is unchanged (there were no runtime options to add).



4. Using unset to clear the `_CEE_RUNOPTS` environment variable does remove it from the sub-shell environment, as shown with the echo command, but it does not change the fact that POSIX(ON) is the active invocation command runtime option in the sub-shell.
5. To see this, we use the `env | grep _CEE_RUNOPTS` command. The env is the target of an exec. We know that the `_CEE_RUNOPTS` environment variable is re-created across the exec from the active invocation command runtime options. And as you can see, the value shows as POSIX(ON). During re-creation, Language Environment uses the minimum abbreviations for the runtime options when re-creating or adding to the `_CEE_RUNOPTS` environment variable.
6. When the env returns, the `_CEE_RUNOPTS` environment variable is still unset in the sub-shell as seen using the echo command.
7. We now use export to set a different value for the `_CEE_RUNOPTS` environment variable in the sub-shell. We see the value using the echo command.
8. Using the `env | grep _CEE_RUNOPTS` command again, we see the behavior where the active invocation command runtime options are added to the current value of the `_CEE_RUNOPTS` environment variable.
9. The rest of the example creates a second sub-shell and shows that the `_CEE_RUNOPTS` environment variable in the sub-shell was added to across the exec of the sub-shell. And again, using unset does not change the active invocation command runtime options.

## **`_EDC_ADD_ERRNO2`**

Controls whether or not `errno2` is appended to the output of `perror()`, `strerror()`, and `strerror_r()`. The `errno2` might be set by the z/OS XL C/C++ runtime library, z/OS UNIX callable services, or other callable services. The `errno2` is intended for diagnostic display purposes only and it is not a programming interface.

The variable `_EDC_ADD_ERRNO2` is not set by default. When the variable `_EDC_ADD_ERRNO2` is not set, `errno2` is added to `perror()` messages, but not to messages retrieved by using `strerror()` or `strerror_r()`. When `_EDC_ADD_ERRNO2` is set to 1, `errno2` is added to `perror()`, `strerror()`, and `strerror_r()` messages. For all other values of `_EDC_ADD_ERRNO2`, `errno2` is not added. For example, for `perror()`, if `errno` was 121, the default behavior might produce the following message "EDC5121I Invalid argument. (errno2=0x0C0F8402)".

`_EDC_ADD_ERRNO2` is set to zero with the command:

```
setenv("_EDC_ADD_ERRNO2","0",1);
```

It is suggested that applications run with `_EDC_ADD_ERRNO2` not being set. This causes `errno2` to be added only to `perror()` messages.

If an application is using `strerror()` or `strerror_r()` to retrieve messages associated with an error number, usually a saved `errno` value, it is suggested that `errno2` also be saved by using `__errno2()` at the time when `errno` is saved. The application can then process the retrieved message and saved `errno2` value as a pair.

**Note:** Not all functions set `errno2` when `errno` is set. In the cases where `errno2` is not set, the `errno2` might be a residual value. You might use the `__err2ad()` function to clear `errno2` to reduce the possibility of a residual value being returned.

## **`_EDC_ANSI_OPEN_DEFAULT`**

Affects the characteristics of MVS text files opened with the default attributes. Issuing the following command causes text files opened with the default characteristics to be opened with a record format of FIXED and a logical record length of 254 in accordance with the ANSI standard for C.

```
setenv("_EDC_ANSI_OPEN_DEFAULT","Y",1);
```

When this environment variable is not specified and a text file is created without its record format or LRECL defined, then the default is a variable record format.

## **`_EDC_AUTOCVT_BINARY`**

If automatic file conversion is enabled (`_BPXK_AUTOCVT=ON` and running with `FILETAG(AUTOCVT)` runtime option), this environment variable activates or deactivates automatic conversion of untagged UNIX file system files opened in binary mode and not opened for record I/O.

The value of this environment variable is checked every time a UNIX file system file is opened. If automatic file conversion is enabled and `_EDC_AUTOCVT_BINARY=YES`, an untagged file opened in binary mode will trigger the file to be automatically converted from the program CCSID to the EBCDIC CCSID as specified by the `_BPXK_CCSDS` environment variable. If `_BPXK_CCSDS` is not set, a default CCSID pair is used. See `_BPXK_CCSDS` environment variable for additional details.

`_EDC_AUTOCVT_BINARY` can be set to the following values to set the conversion state for binary files.

### **NO (default)**

If automatic file conversion is enabled, an untagged file opened in binary mode will not trigger the file to be automatically converted from the program CCSID to the EBCDIC CCSID as specified by the `_BPXK_CCSDS` environment variable. If `_BPXK_CCSDS` is not set, a default CCSID pair is used. See `_BPXK_CCSDS` environment variable for additional details. An untagged file opened in text mode will not be affected.

**YES** If automatic file conversion is enabled, an untagged file opened in binary mode and not opened for record I/O will trigger the file to be automatically converted from the program CCSID to the EBCDIC CCSID as specified by the `_BPXK_CCSDS` environment variable. If `_BPXK_CCSDS` is not set, a default CCSID pair is used. See `_BPXK_CCSDS` environment variable for additional details.

**Note:** If this environment variable is not set, the default behavior is chosen, which is the same as `_EDC_AUTOCVT_BINARY=NO`. Because this environment variable is checked on every file open, an application can pick up the changes to this environment variable by closing and then re-opening the file at execution time. The application itself does not need to be restarted.

## **`_EDC_BYTE_SEEK`**

Indicates to z/OS XL C/C++ that, for all binary files, `ftell()` should return relative byte offsets, and `fseek()` should use relative byte offsets as input. The default behavior is for only binary files with a fixed record format to support relative byte offsets. `_EDC_BYTE_SEEK` is set with the command:

```
setenv("_EDC_BYTE_SEEK","Y",1);
```

## **\_\_EDC\_CLEAR\_SCREEN**

Applies to output text terminal files. `__EDC_CLEAR_SCREEN` is set with the command:  
`setenv("__EDC_CLEAR_SCREEN","Y",1);`

When `__EDC_CLEAR_SCREEN` is set, writing a `\f` (form feed) character to a text terminal sends all preceding unwritten data in the terminal buffer to the screen, and then clears the screen.

When `__EDC_CLEAR_SCREEN` is not set, writing a `\f` (form feed) character to a text terminal results in the character being treated as a non-control character. The character is written to the terminal buffer as `\f`.

## **\_\_EDC\_COMPAT**

Indicates to z/OS XL C/C++ that it should use old functional behavior for various items in code ported from old releases of C/370. These functional items are specified by the value of the environment variable. `__EDC_COMPAT` is set with the following command, where *x* is an integer:

```
setenv("__EDC_COMPAT","x",1);
```

z/OS XL C/C++ converts the string "*x*" into its decimal integer equivalent, and treats this value as a bit mask to determine which functions to use in compatibility mode. The following table interprets the least significant bit as bit zero.

<b>Bit</b>	<b>Function Affected</b>
<b>0</b>	<code>ungetc()</code>
<b>1</b>	<code>ftell()</code>
<b>2</b>	<code>fclose()</code>
<b>3 through 31</b>	Unused

For this release, calls to `fseek()` with an offset of `SEEK_CUR`, `fgetpos()`, and `fflush()` take into account characters pushed back with the `ungetc()` library function. You must set the `__EDC_COMPAT` environment variable for `ungetc()` if you want these functions to ignore `ungetc()` characters as they did in old C/370 code.

For `ftell()`, z/OS XL C/C++ uses an encoding scheme that varies according to the attributes of the underlying data set. You must set the `__EDC_COMPAT` environment variable for `ftell()` if you want to use encoded `ftell()` values generated in old C/370 code.

You can set `__EDC_COMPAT` to indicate that `fclose()` should not unallocate the `SYSOUT=*` data set when it is closing "\*" data sets created under batch. This is to ensure that such data sets can be concatenated with the Job Log, if their attributes are compatible.

Here are some examples of how you can set `__EDC_COMPAT`:

- `setenv("__EDC_COMPAT","1",1);` invokes old `ungetc()` behavior.
- `setenv("__EDC_COMPAT","2",1);` invokes old `ftell()` behavior.
- `setenv("__EDC_COMPAT","3",1);` invokes both old `ungetc()` behavior and old `ftell()` behavior.
- `setenv("__EDC_COMPAT","4",1);` invokes old behavior for spool data sets created by opening "\*" in MVS or IMS batch.

## **`__EDC_CONTEXT_GUARD`**

Allows the user to control the method used to handle the guard page for AMODE 64 user context stacks.

When the value of `__EDC_CONTEXT_GUARD` is set to `ACTIVE`, the guard page for a user context stack is guarded each time the context is given control and unguarded each time the context gives up control. This is the default behavior when the value of `__EDC_CONTEXT_GUARD` is not set.

When the value of `__EDC_CONTEXT_GUARD` is set to `INUSE`, the guard page for a user context stack is guarded the first time the context is given control and unguarded when the context has run to completion, that is, when the function specified on the call to `makecontext()` returns or exits. This method of handling the guard page might provide better performance but comes with the following restrictions:

- The storage for user context stacks must be allocated from the heap.
- The storage for a user context stack cannot be reused or freed until the context runs to completion.

The `__EDC_CONTEXT_GUARD` environment variable can be set with the function:

```
setenv("__EDC_CONTEXT_GUARD", "INUSE", 1);
```

**Note:** The setting of this environment variable is only effective if it is done before the first call to `makecontext()`.

### **Value Description**

#### **ACTIVE**

The user context stack is only guarded when the context is active. This is the default value.

#### **INUSE**

The user context stack is guarded the entire time that the context is in use.

## **`__EDC_C99_NAN`**

Sets the binary floating-point representation of infinite value and Not a Number for the `printf` family of functions as follows:

- When the value of `__EDC_C99_NAN` is set to `YES`, then the `printf` family of functions use C99 compliant behavior. C99 defines the representation of infinity and Not a Number as `INF`, and `NAN` (for `E`, `F`, `G`, and `A` conversion specifiers) or `inf` and `nan` (for `e`, `f`, `g`, and `a` conversion specifiers). In C99 compliant behavior, the case of the string will be the same as the case of the conversion specifier that was used.
- When the value of `__EDC_C99_NAN` is not set, or set to a value other than `YES`, then the representation of infinity and Not a Number is `INF` and `NaN`.

The `__EDC_C99_NAN` environment variable can be set with the function:

```
setenv("__EDC_C99_NAN", "YES", 1);
```

## **`__EDC_DLL_DIAG`**

Indicates if additional DLL diagnostic information should be generated upon failure for the following DLL functions: `dllload()`, `dlopen()`, `dllqueryfn()`, `dllqueryvar()`, `dlsym()`, `dllfree()`, and `dllclose()`. `__EDC_DLL_DIAG` has no effect on implicit DLLs. If `__EDC_DLL_DIAG` is not set by the user, it will default to `QUIET`.

`_EDC_DLL_DIAG` can be set with the following command, where *x* is a string.  
`setenv("_EDC_DLL_DIAG","x",1);`

Acceptable values for *x* are as follows:

**Value Description**

**MSG** Issue DLL error messages to the Language Environment message file.

**TRACE**

Issue all DLL error messages to the Language Environment message file and call the `ctrace()` function to produce a traceback for each error.

**SIGNAL**

Issue all DLL error messages to the Language Environment message file, call the `ctrace()` function to produce a traceback for each error, and signal a condition for each error's feedback code.

**QUIET**

Turn off all `_EDC_DLL_DIAG` error diagnostics; this is the default setting.

The `_EDC_DLL_DIAG` values must be specified in capital letters in order to be recognized. See *z/OS XL C/C++ Runtime Library Reference* for details on the level of diagnostic information provided by `ctrace()`.

There is currently no way to intercept a signaled DLL condition in AMODE 64; therefore, termination is bound to happen if SIGNAL is in effect.

The following list shows examples of how to use `_EDC_DLL_DIAG`.

- Issue a DLL error message for DLL errors.  
`setenv("_EDC_DLL_DIAG","MSG",1);`
- Issue a DLL error message and call the `ctrace()` function for DLL errors.  
`setenv("_EDC_DLL_DIAG","TRACE",1);`
- Issue a DLL error message, call the `ctrace()` function, and signal a condition for DLL errors.  
`setenv("_EDC_DLL_DIAG","SIGNAL",1);`
- Turn off `_EDC_DLL_DIAG` error diagnostics.  
`setenv("_EDC_DLL_DIAG","QUIET",1);`

## **`_EDC_EOVERFLOW`**

Sets the behavior of the `ftell()`, `fseek()`, `fstat()`, `lstat()`, `stat()`, and `mmap()` functions. By default these functions will not check for the EOVERFLOW error condition. Setting `_EDC_EOVERFLOW` to YES enables testing for this condition, and, if overflow is detected, setting `errno` to EOVERFLOW and returning an error. The `_EDC_EOVERFLOW` environment variable can be set with the function:

```
setenv("_EDC_EOVERFLOW","YES", 1);
```

**Value Description**

**YES** Check for EOVERFLOW error conditions.

**<other>**

Ignore setting of EOVERFLOW; this is the default. Equivalent to unsetting the environment variable.

## **`_EDC_ERRNO_DIAG`**

Indicates if additional diagnostic information should be generated, when the `perror()` or `strerror()` functions are called to produce an error message. This environment variable also controls how much additional information is produced. `_EDC_ERRNO_DIAG` is set with the following command, where `x` is an integer and `y` is a list of integer `errno` values, for which additional diagnostic information is desired.

```
setenv("_EDC_ERRNO_DIAG", "x,y", 1);
```

The list of `errno` values must be separated by commas. If the `y` value is omitted, then additional diagnostic information is generated for all `errno` values. If a non-numeric `errno` value is found in `y`, it is treated as 0. Acceptable values for `x` are as follows:

- 0 No additional diagnostic information is generated (This is the default if `_EDC_ERRNO_DIAG` is not set).
- 1 The `ctrace()` function is called to generate additional diagnostic information.
- 2 The `csnap()` function is called to generate additional diagnostic information.
- 3 The `cdump()` function is called to generate additional diagnostic information.

See *z/OS XL C/C++ Runtime Library Reference* for details on the level of diagnostic information provided by the above functions.

The following list shows examples of how to use this environment variable.

- No additional diagnostic information is produced.  

```
setenv("_EDC_ERRNO_DIAG", "0", 1);
```
- The `ctrace()` function is called for any `errno` when `perror()` or `strerror()` are called.  

```
setenv("_EDC_ERRNO_DIAG", "1", 1);
```
- The `csnap()` function is called only when `errno` equals 121 when `perror()` or `strerror()` are called.  

```
setenv("_EDC_ERRNO_DIAG", "2,121", 1);
```
- The `cdump()` function is called only when `errno` equals either 121 or 129 when `perror()` or `strerror()` are called.  

```
setenv("_EDC_ERRNO_DIAG", "3,121,129", 1);
```

## **`_EDC_FLUSH_STDOUT_PIPE`**

Instructs the C Runtime Library to flush the `stdout` stream when the `stdin` stream is being read from. Both `stdin` and `stdout` must be pipes. `_EDC_FLUSH_STDOUT_PIPE` is set with the command:

```
setenv("_EDC_FLUSH_STDOUT_PIPE", "YES", 1);
```

The purpose of this environment variable is to better facilitate communication between two processes that use pipes. The child process is using `stdin` for the read end of one pipe and `stdout` for the write end of a different pipe. The parent process has the opposite ends of the pipes.

Note the following usage notes and examples:

- The child process wants to send a prompt to the parent process and then read the response. The parent process must see the prompt, capture a response, and then send the response back to the child.
- If the child process sends the prompt without a trailing newline or without calling `fflush`, the prompt is never placed into the pipe for the parent process to read. The child process then tries to read the response from `stdin`. The application hangs, which means that the parent process cannot read the prompt that it needs to respond to and the child process cannot read the response from the parent process.
- With the environment variable set to YES, the read from `stdin` will flush the `stdout` buffer. This allows the parent process to see the prompt, respond, and then send the response back to the child process who is waiting on the read. After the data comes back from the parent process, the child process reads the response and continues.

**Note:** The parent process must do a read by using `read()` from the pipe so that it can receive whatever data might be there without having to wait for a specific number of bytes or a newline character. Functions like `fread()` and `fgets()` will hang unless the child process wrote enough bytes or the newline character to `stdout`.

## **`_EDC_FLUSH_STDOUT_SOCKET`**

Instructs the C Runtime Library to flush the `stdout` stream when the `stdin` stream is being read from. Both `stdin` and `stdout` must be sockets.

`_EDC_FLUSH_STDOUT_SOCKET` is set with the command:

```
setenv("_EDC_FLUSH_STDOUT_SOCKET", "YES", 1);
```

The purpose of this environment variable is to better facilitate communication between two processes that use sockets. The child process is using `stdin` for the read end of one socket and `stdout` for the write end of a different socket. The parent process has the opposite ends of the sockets.

Note the following usage notes and examples:

- The child process wants to send a prompt to the parent process and then read the response. The parent process must see the prompt, capture a response, and then send the response back to the child process.
- If the child sends the prompt without a trailing newline or without calling `fflush`, the prompt is never placed into the socket for the parent process to read. The child then tries to read the response from `stdin`. The application hangs, which means that the parent process cannot read the prompt that it needs to respond to and the child process cannot read the response from the parent.
- With the environment variable set to YES, the read from `stdin` will flush the `stdout` buffer. This allows the parent to see the prompt, respond, then send the response back to the child who is waiting on the read. After the data comes back from the parent, the child reads the response and continues.

**Note:** The parent process must do a read by using `read()` from the socket so that it can receive whatever data might be there without having to wait for a specific number of bytes or a newline character. Functions like `fread()` and `fgets()` will hang unless the child wrote enough bytes or the newline character to `stdout`.



## **`_EDC_GLOBAL_STREAMS`**

Used during initialization of the first C main in the environment to allow the C standard streams `stdin`, `stdout`, and `stderr` to have global behavior. The environment variable settings and standard streams using the global behavior, are as follows:

### **Setting Standard streams using global behavior**

0	none
1	<code>stderr</code>
2	<code>stdout</code>
3	<code>stderr,stdout</code>
4	<code>stdin</code>
5	<code>stderr,stdin</code>
6	<code>stdout,stdin</code>
7	<code>stderr,stdout,stdin</code>

**Note:** The first C main would include any Pre-Init Compatibility Interface initialization.

You can use one of the following methods to set the environment variable `_EDC_GLOBAL_STREAMS`:

- CEEBXITA assembler user exit  
You can modify the sample CSECT and assemble and link with the application. The runtime options specified in the CEEBXITA assembler user exit override all other sources of runtime options except those that are specified as NONOVR. These options are honored only during initialization of the first enclave.
- `ENVAR(_EDC_GLOBAL_STREAMS=<setting>)`  
You can call your program with the `ENVAR` runtime option. This overrides the application defaults specified using `CEEUOPT` or the `#pragma runopts` directive.
- `#pragma runopts(ENVAR(_EDC_GLOBAL_STREAMS=<setting>))`  
Use the `#pragma runopts` directive in your application source code.
- `CEEUOPT` application defaults  
Modify the sample CSECT and assemble and link with the application. This overrides corresponding overrideable system-level or region-level default options.

### **Notes:**

1. `_EDC_GLOBAL_STREAMS` is not supported in AMODE 64.
2. Attempts to set this environment variable in the file specified by the `_CEE_ENVFILE` or `_CEE_ENVFILE_S` environment variable are ignored. The standard streams are initialized before that file is read.
3. You cannot use the CEEBINT user exit to set this environment variable. The CEEBINT user exit gets control after the standard streams have been initialized.

## **`_EDC_IEEEV1_COMPATIBILITY_ENV`**

In 1999, the C/C++ Runtime Library provided IEEE754 floating-point arithmetic support in support of IBM's Java™ group. The Java language had a bit-wise requirement for its math library, meaning that all platforms needed to produce the same results as Sun Microsystems' `fdlibm` (Freely Distributed LIBM) library. Therefore, Sun Microsystems' `fdlibm` code was ported to the C/C++ Runtime Library to provide IEEE754 floating-point arithmetic support. Subsequent to the C/C++ Runtime Library's 1999 release of IEEE754 floating-point math support,



IBM's Java group provided their own support of IEEE754 floating point arithmetic and no longer use the C/C++ Runtime Library for this support.

Beginning in z/OS V1R9, a subset of the original fdlibm functions are being replaced by new versions that are designed to provide improved performance and accuracy. The new versions of these functions are replaced at the existing entry points. However, as a migration aid, IBM has provided new entry points for the original fdlibm versions. Applications that take no action will automatically use the updated functions. There are two methods for accessing the original functions.

The first method is through an environment variable, described here, that can be used by applications that do one of the following:

- Do not include <math.h>.
- Include <math.h> and define the `_FP_MODE_VARIABLE` feature test macro.

Either of the above will cause the application to be running in what is called "variable" mode with respect to floating-point math functions called within the compile unit.

The second method is through the `_IEEEV1_COMPATIBILITY` feature test macro and is used for applications that include <math.h> and do not define the `_FP_MODE_VARIABLE` feature test macro. See *z/OS XL C/C++ Runtime Library Reference* for more details.

If the application conforms to the rules of the first method, then this environment variable can be used to access the original fdlibm versions of the functions shown in Table 88.

Table 88. Original versions of fdlibm functions

acos()	acosh()	asin()	asinh()	atan()	atanh()	atan2()
cbrt()	cos()	cosh()	erf()	erfc()	exp()	expm1()
gamma()	hypot()	lgamma()	log()	log1p()	log10()	pow()
rint()	sin()	sinh()	tan()	tanh()		

This environment variable will only take effect if the application is running in "variable" mode. The following list shows the acceptable values of the environment variable and the behavior for each value:

**ON** Original versions of fdlibm functions are used.

**other values**

The new versions of the functions are used. This is the default.

If the application has used `__fp_setmode()` to switch over to hexadecimal floating-point mode, the hexadecimal versions of the functions will be called no matter the setting of the environment variable.

## **`_EDC_IO_ABEND`**

When an abend condition arises during OS I/O processing, the zOS XL C/C++ runtime library ignores the condition, if possible. When the abend condition cannot be ignored, the abend is issued. This environment variable controls if the runtime library should attempt to recover from an abend issued during OS I/O processing. The acceptable values for the environment variable are as follows:

**ABEND**

Specifies that the runtime library is to ignore abend conditions that can be

ignored and that the runtime library should not attempt to recover from an abend issued during OS I/O processing. When an abend is issued during OS I/O processing, Language Environment condition handling semantics take effect. The only methods available for the application to attempt to recover are to write a Language Environment condition handler or a SIGABND signal handler. If this environment value is not set or if a value other than ABEND or RECOVER is specified, this is the default behavior.

#### RECOVER

Specifies that the runtime library is to ignore abend conditions that can be ignored and also that the runtime library should attempt to recover from an abend issued during OS I/O processing. If the library can recover, then control will be returned to the application as a failing return value, with `errno` set to 92 and diagnostic information in the `__amrc` structure. If the library cannot recover, Language Environment condition handling semantics take effect.

#### Notes:

1. The value is not case sensitive.
2. When a stream is opened, the current setting of the environment variable defines the behavior for the life of the open stream, unless overridden by the abend keyword specified in the `modestring` on the `fopen()` or `freopen()` call.
3. Changes to the environment variable do not affect existing open streams.
4. This environment variable has no effect for SPC applications.

For more information about error handling during I/O operations, refer to Chapter 10, "Performing OS I/O operations," on page 83.

The following example show one method to set this environment variable.

```
setenv("_EDC_IO_ABEND", "RECOVER", 1);
```

## \_EDC\_IO\_TRACE

Indicates which files to perform file I/O tracing on, the level of detail to provide for file I/O tracing, and the trace buffer size to use for each file. The `_EDC_IO_TRACE` format is:

```
_EDC_IO_TRACE=(Filter,Detail,Buffer Size)
```

The three values (Filter, Detail, Buffer Size) must be surrounded by parenthesis and delimited by commas. Values that are left blank use the default setting for that value.

#### Value Description

**Filter** Indicates which files to trace.

```
//DD:filter
```

Trace will include the DD names matching the specified filter string.

```
//filter
```

Trace will include the MVS data sets matching the specified filter string. Member names of partitioned data sets cannot be matched without the use of a wildcard.

```
filter
```

Trace will include the Unix files matching the specified filter string.

```
//DD:*
```

Trace will include all DD names.

- `//*` Trace will include all MVS data sets. This is the default setting.
- `/*` Trace will include all Unix files.
- `*` Trace will include all MVS data sets and Unix files.

**Detail** Indicates the level of detail provided by the trace.

- 0** No tracing will be performed. This is the default setting.
- 1** First level tracing will be performed. The trace includes the following information:
  - The file being traced.
  - The trace detail level and buffer size.
  - Details describing how the file was opened (the function called and parameters passed).
  - Formatted file data returned from `fldata()`.
  - The file pointer address.
  - The DD name, if applicable.
  - The function flow details for entry to externally documented file I/O functions.
- 2** Second level tracing will be performed. The trace includes everything that the first level tracing includes, except that the function flow details will be for entry to externally documented and internal slot, exit, OS, and open file I/O functions.

#### Buffer Size

Indicates the buffer size to use for each file's function flow details.

##### **sizeK**

Specifies the size of each file's trace buffer, where `size` is a number specified in kilobytes. The default buffer size is 16KB.

##### **sizeM**

Specifies the size of each file's trace buffer, where `size` is a number specified in megabytes.

#### Notes:

1. The wildcard character (`*`) can be used alone or as a part of a filter. If it is used as a part of a filter, it must be located at the end of the filter string.
2. The Unix file filter must either be a fully qualified name or a file name with no slashes.
3. If the trace buffer size is used up, the trace buffer will wrap, overwriting function flow details only.
4. The usage of `setenv()` with `_EDC_IO_TRACE` only has an effect on future files that are opened.

The following examples show different ways you can use this environment variable.

- The following examples demonstrate two different ways to trace the default of all MVS data sets, using level 1 tracing and the default trace table size:
 

```
export _EDC_IO_TRACE=(,1,)
setenv("_EDC_IO_TRACE", "(,1,)", 1);
```
- The following examples demonstrate two different ways to trace the UNIX file named `posix.data`, using level 1 tracing and the default trace table size:

```
export _EDC_IO_TRACE=(posix.data,1,)
setenv("_EDC_IÖ_TRACE","(posix.data,1,)",1);
```

- The following examples demonstrate two different ways to trace all MVS data sets with names that begin with POSIX.DATA, using level 1 tracing and the default trace table size:

```
export _EDC_IO_TRACE=(//POSIX.DATA*,1,)
setenv("_EDC_IÖ_TRACE","(//POSIX.DATA*,1,)",1);
```

- The following examples demonstrate two different ways to trace all MVS data sets with names that begin with POSIX.DATA, using level 1 tracing and size 24K trace tables:

```
export _EDC_IO_TRACE=(//POSIX.DATA*,1,24K)
setenv("_EDC_IÖ_TRACE","(//POSIX.DATA*,1,24K)",1);
```

## **\_\_EDC\_OPEN\_CONCAT**

Enables users to control if the C library can recognize that a data set is concatenated or not on `fopen()`.

By default, a concatenated data set can only be recognized when it is opened by DDNAME, but it cannot be recognized when it is opened by the data set name. The acceptable value for the `__EDC_OPEN_CONCAT` environment variable is:

<b>Value</b>	<b>Description</b>
--------------	--------------------

- |          |   |
|----------|---|
| <b>1</b> | The C library is able to recognize that the data set is concatenated or not when it is opened by the data set name. With this setting, repositioning operations upon a GDG data set opened by its base name will be based on the beginning of the GDG base. |
|----------|---|

The `__EDC_OPEN_CONCAT` environment variable can be set with the following function:

```
setenv("__EDC_OPEN_CONCAT","1",1);
```

## **\_\_EDC\_POPEN**

Sets the behavior of the `popen()` function. When the value of `__EDC_POPEN` is set to `FORK`, `popen()` uses `fork()` to create the child process. When the value of `__EDC_POPEN` is set to `SPAWN`, `popen()` uses `spawn()` to create the child process. If the value of `__EDC_POPEN` is not set, the default behavior is for `popen()` to use `fork()` to create the child process.

The `__EDC_POPEN` environment variable can be set with the function

```
setenv("__EDC_POPEN","SPAWN", 1);
```

## **\_\_EDC\_PTHREAD\_YIELD**

Used to control when `pthread_yield()` and `sched_yield()` will allow a thread to give up control of a processor so that another thread may have the opportunity to run. Possible values for `__EDC_PTHREAD_YIELD`:

- |           |   |
|-----------|---|
| <b>0</b>  | Control of the processor is released immediately.   |
| <b>-1</b> | Use an internal timing algorithm to determine if the processor should be released. This is the default. |
| <b>-2</b> | Take the machine speed into account when determining if the processor should be released.               |

**other negative values**

Invalid. The default (-1) will be used.

**Notes:**

1. `_EDC_PTHREAD_YIELD` may be changed by `setenv()` while the application is running. All threads will use the new value.
2. The use of `_EDC_PTHREAD_YIELD=-2` is suggested.

Examples of setting `_EDC_PTHREAD_YIELD`:

```
export _EDC_PTHREAD_YIELD=-1
set the ENVAR("_EDC_PTHREAD_YIELD=-2") runtime option
```

## **`_EDC_PTHREAD_YIELD_MAX`**

This environment variable allows a user program to define the max yield (wait) time for a particular thread. It is used to configure the speed at which the `pthread_yield()` and `sched_yield()` functions release a processor to enable another thread to run. In some cases, such as in highly-threaded applications, improved performance may result by using this environment variable to reduce the default max wait time.

### **Value Description**

#### **positive value**

An integer value to set the maximum yield time allowable for a pthread to wait. This value represents microseconds (1/1000 of a millisecond).

**Note:** Values above 32000 (which is the current max default) and values less than or equal to zero will be ignored.

Examples of setting `_EDC_PTHREAD_YIELD_MAX`:

- This example results in wait times starting at 10 milliseconds, doubling on every successive wait (as it always has) up to a maximum of 20 milliseconds for every wait after that.

```
ENVAR("_EDC_PTHREAD_YIELD_MAX=20000")
(and _EDC_PTHREAD_YIELD=-1)
```

- This example results in wait times starting at an interval determined by the hardware processor speed, and doubling at every successive wait for a maximum wait of 1000 microseconds.

```
ENVAR("_EDC_PTHREAD_YIELD_MAX=1000")
(and _EDC_PTHREAD_YIELD=-2)
```

- This example will result in wait times starting at 1 microsecond, doubling on every successive wait up to a maximum of 1 millisecond.

```
ENVAR("_EDC_PTHREAD_YIELD_MAX=1000")
(and _EDC_PTHREAD_YIELD=4096)
```

**Note:** A positive integer specified in `_EDC_PTHREAD_YIELD` determines the initial Time Unit a thread will wait for; in this example, 4096 is equivalent to 1 microsecond.

- This example results in wait times that start at 10 milliseconds and remain at that wait time for every successive wait, because the starting yield time is much longer than the intended maximum wait time.

```
ENVAR("_EDC_PTHREAD_YIELD_MAX=10")
(and _EDC_PTHREAD_YIELD=-1)
```

## **`_EDC_PUTENV_COPY`**

Sets the behavior of the `putenv()` function. When the value of `_EDC_PUTENV_COPY` is set to YES, the `putenv()` string is copied into storage owned by Language

Environment. When the value of `_EDC_PUTENV_COPY` is *not* set, or set to a value other than YES, then the `putenv()` string is placed directly into the environment, so altering the string will change the environment..

The `_EDC_PUTENV_COPY` environment variable can be set with the function

```
setenv("_EDC_PUTENV_COPY","YES", 1);
```

**Notes:**

1. Changes to z/OS specific environment variables beginning with `_BPXK_`, `_CEE_` or `_EDC_` may not be processed if the environment variable is updated directly rather than by using `setenv()` or `putenv()`. Results are unpredictable if these type of environment variables are updated directly.
2. For ASCII applications, the users string will be placed into the environment. However, updates should only be made with `setenv()` or `putenv()`. Results are unpredictable if the environment variable is updated directly.
3. If the user manually changes the environment, storage associated with the original environment may never be freed.
4. The `__putenv_la()` function will always make a copy of the user string and perform as though `_EDC_PUTENV_COPY=YES` were specified.
5. `_EDC_PUTENV_COPY` may be updated during the life of the application by `setenv()`, `putenv()` or `clearenv()`. This will affect the behavior of any subsequent call to `putenv()`, however it will not change the state of existing environment variables. `putenv()` may be used to update `_EDC_PUTENV_COPY`. The behavior requested will not take effect until the next `putenv()` call.

## **`_EDC_RRDS_HIDE_KEY`**

Applies to VSAM RRDS files opened in record mode. When this environment variable is set, you can call `fread()` with a pointer to a character string, and the Relative Record Number is not appended to the beginning of the record. The `_EDC_RRDS_HIDE_KEY` environment variable is set with the command

```
setenv("_EDC_RRDS_HIDE_KEY","Y",1);
```

By default, when you open a VSAM record in record mode, the `fread()` function is called with the RRDS record structure, and the record is preceded by the Relative Record Number.

## **`_EDC_STOR_INCREMENT`**

Sets the size of increments to the internal library storage subpool acquired above the 16M line. By default, when the storage subpool is filled, its size is incremented by 8K. When `_EDC_STOR_INCREMENT` is set, its value string is translated to its decimal integer equivalent. This integer is then the new setting of the subpool storage increment size. The setting of this environment variable is only effective if it is done before the first I/O in the enclave.

The `_EDC_STOR_INCREMENT` value must be greater than zero, and must be a multiple of 4K. If the value is less than zero, the default setting of 8K is used. If the value is not a multiple of 4K, then it is rounded up to the next 4K interval. If `_EDC_STOR_INCREMENT` is set to an invalid value that must be modified internally to be divisible by 4K, this modification is not reflected in the character string that appears in the environment variable table.

Consider the case where `setenv()` is called as follows:

```
setenv("_EDC_STOR_INCREMENT","9000",1);
```

Internally, the storage subpool increment value is set to 12288 (that is, 12K). However, the following subsequent call returns "9000", as set by the call to `setenv()`.

```
getenv("_EDC_STOR_INCREMENT");
```

**Note:** `_EDC_STOR_INCREMENT` is not supported in AMODE 64. In AMODE 64 this environment variable is replaced by the IOHEAP64 runtime option.

## **`_EDC_STOR_INCREMENT_B`**

Sets the increment size of an internal library storage subpool acquired below the 16M line. By default, when the below the line storage subpool is filled, its size is incremented by 4K. When `_EDC_STOR_INCREMENT_B` is set, its value string is translated to the decimal equivalent. These integers are then used as the new settings of the below subpool storage increment sizes. The setting of this environment variable is only effective if it is done before the first I/O in the enclave.

Consider the case where `setenv()` is called from CEEBINT (with the CEEBINT user exit linked to the application) as follows:

```
setenv("_EDC_STOR_INCREMENT_B","1000",1);
```

Internally, the storage subpool acquired from 24-bit storage will be 4096 (or 4K). However, the following subsequent call returns "1000", as set by the `setenv()` call.

```
getenv("_EDC_STOR_INCREMENT_B");
```

**Note:** `_EDC_STOR_INCREMENT_B` is not supported in AMODE 64. In AMODE 64, this environment variable is replaced by the IOHEAP64 runtime option.

## **`_EDC_STORE_INITIAL`**

Sets the initial size of the internal library storage subpool acquired above the line. The default subpool storage size is 12K. When `_EDC_STORE_INITIAL` is set, its value string is translated to its decimal integer equivalent. This integer is then the new setting of the subpool storage increment size. The setting of this environment variable is only effective if it is done before the first I/O in the enclave.

The `_EDC_STORE_INITIAL` value must be greater than zero, and must be a multiple of 4K. If the value is less than zero, the default setting of 12K is used. If the value is not a multiple of 4K, then it is rounded up to the next 4K interval. If `_EDC_STORE_INITIAL` is set to an invalid value that must be modified internally to be divisible by 4K, this modification is not reflected in the character string that appears in the environment variable table.

Consider the case where `setenv()` is called from CEEBINT as follows, and the CEEBINT user exit linked to the application:

```
setenv("_EDC_STORE_INITIAL","16000",1);
```

Internally, the storage subpool is initialized to 16384 (that is, 16K). However, the subsequent call, shown in the following example, returns "16000", as set by the `setenv()` call:

```
getenv("_EDC_STORE_INITIAL");
```

**Note:** `_EDC_STORE_INITIAL` is not supported in AMODE 64. In AMODE 64, this environment variable is replaced by the IOHEAP64 runtime option.



## **\_\_EDC\_STOR\_INITIAL\_B**

Sets the initial size of an internal library storage subpool acquired below the 16M line. The default below the line subpool storage size is 4K. When `__EDC_STOR_INITIAL_B` is set, its value string is translated to the decimal integer equivalent. This integer is then used as the new setting of the above the line subpool storage initial size. The setting of this environment variable is only effective if it is done before the first I/O in the enclave.

Consider the case where `setenv()` is called from CEEBINT as follows, and with the CEEBINT user exit linked to the application.

```
setenv("__EDC_STOR_INITIAL_B","1000",1);
```

Internally, the storage subpool acquired from 24-bit storage will be set to 4096 (that is, 4K). However, the subsequent call `getenv("__EDC_STOR_INITIAL_B");` returns "1000", as set by the `setenv()` call.

**Note:** `__EDC_STOR_INITIAL_B` is not supported in AMODE 64. In AMODE 64, this environment variable is replaced by the IOHEAP64 runtime option.

## **\_\_EDC\_STRPTM\_STD**

Indicates changes to `strptime()` that are provided for UNIX standard compliance. It would affect the behavior of the following conversion specifier of the `strptime()` function:

**%Y** When the value of `__EDC_STRPTM_STD` is set to 1, at most 4 digits will be consumed. When the value of `__EDC_STRPTM_STD` is set to other values or unset, more than 4 digits might be consumed, and if the generated value is greater than 9999, this function fails.

## **\_\_EDC\_SUSV3**

Indicates behavioral changes that are provided for SUSV3 compliance in an error path. The affected interfaces are typically setting `errno` to values that were not used before and, in some cases, returning failure for conditions that had not been tested before SUSV3. By default the affected interfaces will not check for these conditions. When the value of `__EDC_SUSV3` is set to 1, the SUSV3 behavior is enabled. When the value of `__EDC_SUSV3` is set to 2, all the behaviors protected by `__EDC_SUSV3=1` are exposed, and pole error related behaviors specified by SUSV3 will be enabled.

For the use of `__EDC_SUSV3` in individual interface, see *z/OS XL C/C++ Runtime Library Reference*. The functions that are affected by the `__EDC_SUSV3` environment variable are:

**When `__EDC_SUS3 = 1` or `__EDC_SUS3 = 2`:**

```
setenv(), readdir(), getnameinfo(), and tcgetsid()
```

**When `__EDC_SUS3 = 2`:**

```
log(), logf(), logl(), log10(), log10f(), log10l(), log1p(), log1pf(),  
log1pl(), log2(), log2f(), log2l(), pow(), and powl()
```

The `__EDC_SUSV3` environment variable can be set with the function:

```
setenv("__EDC_SUSV3","1",1);
```

**1** Enables SUSV3 behavior for `setenv()`, `readdir()`, `getnameinfo()`, and `tcgetsid()`.



- 2 Also enables SUSV3 behavior for `log()`, `logf()`, `logl()`, `log10()`, `log10f()`, `log10l()`, `log1p()`, `log1pf()`, `log1pl()`, `log2()`, `log2f()`, `log2l()`, `pow()`, and `powl()`.

## **\_\_EDC\_UMASK\_DFLT**

Allows the user to control how the C library sets the default umask that is used when the program runs. If z/OS UNIX services are available, the possible values of the `__EDC_UMASK_DFLT` environment variable are as follows:

### **NO (case insensitive)**

The C runtime library does not change the default umask value, which depends on how BPXPRMxx statement UMASK is set.

### **A valid octal value**

The library uses this octal value as the default umask value. The BPXPRMxx statement UMASK is overridden by this value.

### **Any other value**

If the BPXPRMxx statement UMASK is set to a valid value, the default umask value is the same as that value; otherwise, the C runtime library establishes a default umask value of 022.

## **\_\_EDC\_ZERO\_RECLEN**

Allows processing of zero-length records in an MVS Variable file opened in either record or text mode. For more information, see Chapter 10, "Performing OS I/O operations," on page 83. `__EDC_ZERO_RECLEN` is set with the command:

```
setenv("__EDC_ZERO_RECLEN","Y",1);
```

This environment variable has no effect on streams based on UNIX file system files. You can always read and write zero-byte records in UNIX file system files.

---

## **Propagating environment variables**

Figure 149 on page 503 shows a sample program (CCNGEV1) that sets the environment variable `__EDC_ANSI_OPEN_DEFAULT`. A child program is then initiated by a system call. This example shows that environment variables are propagated forward, but not backward.

---

```

/* this example shows how environment variables are propagated */
/* part 1 of 2-other file is CCNGEV2 */

#include <stdio.h>
#include <stdlib.h>

int main(void) {
    char *x;

    /* set the environment variable _EDC_ANSI_OPEN_DEFAULT */
    setenv("_EDC_ANSI_OPEN_DEFAULT", "Y", 1);

    /* set x to the current value of _EDC_ANSI_OPEN_DEFAULT */
    x = getenv("_EDC_ANSI_OPEN_DEFAULT");

    printf("ccngev1 _EDC_ANSI_OPEN_DEFAULT = %s\n",
        (x != NULL) ? x : "undefined");

    /* call the child program */
    system("ccngev2");

    /* set x to the current value of _EDC_ANSI_OPEN_DEFAULT */
    x = getenv("_EDC_ANSI_OPEN_DEFAULT");

    printf("ccngev1 _EDC_ANSI_OPEN_DEFAULT = %s\n",
        (x != NULL) ? x : "undefined");

    return(0);
}

```

---

*Figure 149. Environment variables example-Part 1*

Figure 150 is another sample program (CCNGEV2) to show how environment variables are propagated.

---

```

/* this example shows how environment variables are propagated */
/* part 2 of 2-other file is CCNGEV1 */

#include <stdio.h>
#include <stdlib.h>

int main(void) {
    char *x;

    /* set x to the current value of _EDC_ANSI_OPEN_DEFAULT */
    x = getenv("_EDC_ANSI_OPEN_DEFAULT");

    printf("ccngev2 _EDC_ANSI_OPEN_DEFAULT = %s\n",
        (x != NULL) ? x : "undefined");

    /* clear the Environment Variables Table */
    clearenv();

    /* set x to the current value of _EDC_ANSI_OPEN_DEFAULT */
    x = getenv("_EDC_ANSI_OPEN_DEFAULT");
    printf("ccngev2 _EDC_ANSI_OPEN_DEFAULT = %s\n",
        (x != NULL) ? x : "undefined");

    return(0);
}

```

---

*Figure 150. Environment variables example-Part 2*

The preceding program produces the following output:

```
cbcgev1 _EDC_ANSI_OPEN_DEFAULT = Y
ccngev2 _EDC_ANSI_OPEN_DEFAULT = Y
ccngev2 _EDC_ANSI_OPEN_DEFAULT = undefined
ccngev1 _EDC_ANSI_OPEN_DEFAULT = Y
```

---

## Chapter 33. Using hardware built-in functions

This section assumes the user has knowledge of assembler opcodes and assembler programming.

A built-in function is inline code that is generated in place of an actual function call. The hardware built-in functions send requests to the compiler to use instructions that are not typically generated by the compiler. Extra instructions are generated to load the parameters for the operation and to store the result. These functions require that the LANGLVL not be set to ANSI. For more information about a given instruction, refer to the *z/Architecture Principles of Operation*.

### Notes:

1. Using a built-in hardware instruction does not guarantee that a hardware instruction will be generated. The compiler can decide that it is not necessary to generate the code.
2. In some cases, the instruction will be generated as data before it is executed via an EX instruction. This occurs whenever a parameter:
  - Must be put in a mask or displacement field.
  - Is specified as a non-literal instead of a literal.

It is more efficient to execute the target instruction for a hardware built-in function without generating an EX instruction. If possible, some parameters of the built-in functions should be specified as literal for better performance. For examples, see Table 98 on page 529.

---

## General instructions

General hardware built-in functions are intended to provide access to general purpose instructions that are not normally generated by the compiler. For more information on these instructions, see chapter 7 of the *z/Architecture Principles of Operation*.

**Note:** Before you use any of the instructions listed in Table 90 on page 507 in your program, you must include the `builtin.h` header file (unless the instructions are otherwise specified) and compile the program with the `LANGLVL(EXTENDED)` option or the `LANGLVL(LIBEXT)` option.

Table 89. Standard general-instruction prototypes

PROTOTYPE and Notes	Sample Pseudo Assembly	MIN ARCH
<code>int __cds1(void* OP1, void* OP2, void* OP3)</code> <b>Note:</b> The user must include <code>stdlib.h</code> to use this built-in function. It is similar to <code>cds()</code> but does not explicitly set the type to be swapped in the prototype.	<code>CDS OP1,OP3,OP2D(OP2B)</code>	ARCH(0)
<code>int __cdsg(void* OP1, void* OP2, void* OP3)</code> <b>Note:</b> The user must include <code>stdlib.h</code> to use this built-in function. It is similar to <code>cdsg()</code> but does not explicitly set the type to be swapped in the prototype.	<code>CDSG OP1,OP3,OP2D(OP2B)</code>	ARCH(5) with LP64

Table 89. Standard general-instruction prototypes (continued)

PROTOTYPE and Notes	Sample Pseudo Assembly	MIN ARCH
int __cs1(void* OP1, void* OP2, void* OP3) <b>Notes:</b> <ul style="list-style-type: none"> <li>The user must include <code>stdlib.h</code> to use this built-in function. It is similar to <code>cs()</code> but does not explicitly set the type to be swapped in the prototype.</li> <li>OP1 and OP2 cannot be the same memory reference.</li> </ul>	CS OP1,OP3,OP2D(OP2B)	ARCH(0)
int __csg(void* OP1, void* OP2, void* OP3) <b>Note:</b> The user must include <code>stdlib.h</code> to use this built-in function. It is similar to <code>csg()</code> but does not explicitly set the type to be swapped in the prototype.	CSG OP1,OP3,OP2D(OP2B)	ARCH(5) with LP64
void __dcbf(const void* OP2)  It releases the cache line containing the specified address (OP2) from all accesses.	PFD M1,OP2 <b>Note:</b> M1 is a code generated by the compiler with a value of 7.	ARCH(8)
void __dcbst(const void* OP2)  It releases the cache line containing the specified address (OP2) from store access and retains the data in the cache line for fetch access.	PFD M1,OP2 <b>Note:</b> M1 is a code generated by the compiler with a value of 6.	ARCH(8)
void __dcbt(const void* OP2)  It prefetches the cache line containing the specified address (OP2) into the cache for fetch access.	PFD M1,OP2 <b>Note:</b> M1 is a code generated by the compiler with a value of 1.	ARCH(8)
void __dcbtst(const void* OP2)  It prefetches the cache line containing the specified address (OP2) into the cache for store access.	PFD M1,OP2 <b>Note:</b> M1 is a code generated by the compiler with a value of 2.	ARCH(8)
void __pack (unsigned char *OP1, unsigned char op1_len, unsigned char *OP2, unsigned char op2_len) <ul style="list-style-type: none"> <li>The format of OP2 is changed from zoned to signed-packed-decimal, and the result is placed at OP1 location.</li> <li>OP2 is treated as having the zoned format. The numeric bits of each byte are treated as a digit. The zone bits are ignored, except the zone bits in the rightmost byte, which are treated as a sign.</li> <li>The sign and digits are moved unchanged to OP1 and are not checked for valid codes. The sign is placed in the rightmost four bit positions of the rightmost byte of the result field, and the digits are placed adjacent to the sign and to each other in the remainder of the result field.</li> <li>The result is obtained as if the operands were processed right to left. When necessary, OP2 is considered to be extended on the left with zeros. If OP1 field is too short to contain all digits of OP2, the remaining leftmost portion of OP2 is ignored. Access exceptions for the unused portion of OP2 may or may not be indicated.</li> <li>op1_len specifies the zero-based length of OP1, which is the number of additional bytes to the right of OP1. A length of 1 is represented by 0, a length of 2 is represented by 1, and so forth. op1_len must be in the range of 0 to 15 inclusive.</li> <li>op2_len specifies the zero-based length of OP2, which is the number of additional bytes to the right of OP2. A length of 1 is represented by 0, a length of 2 is represented by 1, and so forth. op2_len must be in the range of 0 to 15 inclusive.</li> </ul>	PACK OP1D(op1_len,OP1B), OP2D(op2_len,OP2B)	ARCH(0)

Table 89. Standard general-instruction prototypes (continued)

PROTOTYPE and Notes	Sample Pseudo Assembly	MIN ARCH
<p>void __tr (unsigned char *OP1, const unsigned char *OP2, unsigned char len)</p> <ul style="list-style-type: none"> <li>The bytes of OP1 are used as eight-bit arguments to reference a list designated by the address of OP2. Each function byte selected from the list replaces the corresponding argument in OP1.</li> <li>len specifies the zero-based length of OP1, which is the number of additional bytes to the right of OP1. A length of 1 is represented by 0, a length of 2 is represented by 1, and so forth. len must be in the range of 0 to 255 inclusive.</li> <li>The bytes of OP1 are selected one by one for translation, proceeding left to right. Each argument byte is added to the initial OP2 address. The addition is performed following the rules for address arithmetic, with the argument byte treated as an eight-bit unsigned binary integer and extended with zeros on the left. The sum is used as the address of the function byte, which then replaces the original argument byte.</li> <li>The operation proceeds until the OP1 field is exhausted. The list is not altered unless an overlap occurs.</li> <li>When the operands overlap, the result is obtained as if each result byte were stored immediately after fetching the corresponding function byte.</li> </ul>	<pre>TR OP1D(len,OP1B), OP2D(OP2B)</pre>	<p>ARCH(0)</p>

Table 90. Built-in general-instruction prototypes

PROTOTYPE and Notes	Sample Pseudo Assembly	MIN ARCH
<p>int __clcle(char *OP1, unsigned long op1_len, unsigned char OP2, char *OP3, unsigned long op3_len)</p> <p>Operands:</p> <ul style="list-style-type: none"> <li>OP1 represents the first operand in the hardware instruction.</li> <li>op1_len specifies the zero-based length of OP1, which is the number of additional bytes to the right of OP1. A length of 1 is represented by 0, a length of 2 is represented by 1, and so forth.</li> <li>OP2 specifies the number of bytes to pad the shorter operand on the right.</li> <li>OP3 represents the third operand in the hardware instruction.</li> <li>op3_len specifies the zero-based length of OP3, which is the number of additional bytes to the right of OP3. A length of 1 is represented by 0, a length of 2 is represented by 1, and so forth.</li> </ul> <p><b>Note:</b> If the LP64 compiler option is in effect, the op1_len and op3_len operands are 64-bit unsigned integers. Otherwise, op1_len and op3_len are 32-bit unsigned integers. The return value is the condition code set by the CLCLE instruction.</p> <p><b>Note:</b> When the condition code is 3, the condition is handled by the compiler-generated code.</p>	<pre>L R2, OP1 L R3, op1_len L R4, OP3 L R5, op3_len CLCLE R2, R4, OP2D(OP2B)</pre>	<p>ARCH(2)</p>

Table 90. Built-in general-instruction prototypes (continued)

PROTOTYPE and Notes	Sample Pseudo Assembly	MIN ARCH
<p>int __clclu(unsigned short *OP1, unsigned long op1_len, unsigned short OP2, unsigned short *OP3, unsigned long op3_len)</p> <p>Operands:</p> <ul style="list-style-type: none"> <li>• OP1 represents the first operand in the hardware instruction.</li> <li>• op1_len specifies the zero-based length of OP1, which is the number of additional bytes to the right of OP1. A length of 1 is represented by 0, a length of 2 is represented by 1, and so forth.</li> <li>• OP2 specifies the number of bytes to pad the first operand on the right, in the event that it is shorter than the third operand.</li> <li>• OP3 represents the third operand in the hardware instruction.</li> <li>• op3_len specifies the zero-based length of OP3, which is the number of additional bytes to the right of OP3. A length of 1 is represented by 0, a length of 2 is represented by 1, and so forth.</li> </ul> <p><b>Notes:</b></p> <ul style="list-style-type: none"> <li>• If the LP64 compiler option is in effect, the op1_len and op3_len operands are 64-bit unsigned integers. Otherwise they are 32-bit unsigned integers.</li> <li>• If the operand values are odd numbers, a specification exception will be triggered by the hardware.</li> </ul> <p>The return value is the condition code set by the CLCLU instruction.  <b>Note:</b> When the condition code is 3, the condition is handled by the compiler-generated code.</p>	<pre>L R2, OP1 L R3, op1_len L R4, OP3 L R5, op3_len CLCLU R2, R4, OP2D(OP2B)</pre>	<p>ARCH(6)</p>
<p>int __cu12(unsigned short *OP1, unsigned long op1_len, char *OP2, unsigned long op2_len, char **invalid_utf8, unsigned char mask)</p> <p>Operands:</p> <ul style="list-style-type: none"> <li>• OP1 represents the first operand in the hardware instruction. OP1 points to the storage location for receiving the converted UTF-16 characters.</li> <li>• op1_len specifies the zero-based length of OP1, which is the number of additional bytes to the right of OP1. A length of 1 is represented by 0, a length of 2 is represented by 1, and so forth.</li> <li>• OP2 represents the second operand in the hardware instruction. OP2 points to the source UTF-8 characters.</li> <li>• op2_len specifies the zero-based length of OP2, which is the number of additional bytes to the right of OP2. A length of 1 is represented by 0, a length of 2 is represented by 1, and so forth.</li> <li>• invalid_utf8 points to a pointer field for receiving the address of the invalid UTF-8 character in the source when the condition code is "2".</li> <li>• mask specifies the mask encoded in the machine instruction; it must be a literal value of either 0 or 1.</li> </ul> <p><b>Note:</b> If option LP64 is specified, both op1_len and op2_len are 64-bit unsigned integers. Otherwise they are 32-bit unsigned integers.</p> <p>The return value is the condition code set by the CU12 instruction.  <b>Note:</b> When the condition code is 3, the condition is handled by the compiler-generated code.</p>	<pre>L R2, OP1 L R3, op1_len L R4, OP2 L R5, op2_len CU12 R2, R4, Mask</pre>	<p>ARCH(7)</p>

Table 90. Built-in general-instruction prototypes (continued)

PROTOTYPE and Notes	Sample Pseudo Assembly	MIN ARCH
<p>int __cu14 (unsigned int *OP1, unsigned long op1_len, char *OP2, unsigned long op2_len, unsigned char **invalid_utf8, unsigned char mask)</p> <p>Operands:</p> <ul style="list-style-type: none"> <li>• OP1 represents the first operand in the hardware instruction. OP1 points to the storage location for receiving the converted UTF-32 characters.</li> <li>• op1_len specifies the zero-based length of OP1, which is the number of additional bytes to the right of OP1. A length of 1 is represented by 0, a length of 2 is represented by 1, and so forth.</li> <li>• OP2 represents the second operand in the hardware instruction. OP2 points to the source UTF-8 characters.</li> <li>• op2_len specifies the zero-based length of OP2, which is the number of additional bytes to the right of OP2. A length of 1 is represented by 0, a length of 2 is represented by 1, and so forth.</li> <li>• invalid_utf8 points to a pointer field for receiving the address of the invalid UTF-8 character in the source when the condition code is "2".</li> <li>• mask specifies the mask encoded in the machine instruction; it must be a literal value of either 0 or 1.</li> </ul> <p><b>Note:</b> If option LP64 is specified, both op1_len and op2_len are 64-bit unsigned integers. Otherwise they are 32-bit unsigned integers.</p> <p>The return value is the condition code set by the CU14 instruction.  <b>Note:</b> When the condition code is 3, the condition is handled by the compiler-generated code.</p>	<pre>L R2, OP1 L R3, op1_len L R4, OP2 L R5, op2_len CU14 R2, R4, Mask ST *invalid_utf8,R4</pre>	<p>ARCH(7)</p>
<p>int __cu21(char *OP1, unsigned long op1_len, unsigned short *OP2, unsigned long op2_len, unsigned char mask)</p> <p>Operands:</p> <ul style="list-style-type: none"> <li>• OP1 represents the first operand in the hardware instruction. OP1 points to the storage location for receiving the converted UTF-8 characters.</li> <li>• op1_len specifies the zero-based length of OP1, which is the number of additional bytes to the right of OP1. A length of 1 is represented by 0, a length of 2 is represented by 1, and so forth.</li> <li>• OP2 represents the second operand in the hardware instruction. OP2 points to the source 2-byte Unicode characters.</li> <li>• op2_len specifies the zero-based length of OP2, which is the number of additional bytes to the right of OP2. A length of 1 is represented by 0, a length of 2 is represented by 1, and so forth.</li> <li>• mask specifies the mask encoded in the machine instruction; it must be a literal value of either 0 or 1.</li> </ul> <p><b>Note:</b> If option LP64 is specified, both op1_len and op2_len are 64-bit unsigned integers. Otherwise they are 32-bit unsigned integers.</p> <p>The return value is the condition code set by the CU21 instruction.  <b>Note:</b> When the condition code is 3, the condition is handled by the compiler-generated code.</p>	<pre>L R2, OP1 L R3, op1_len L R4, OP2 L R5, op2_len CU21 R2, R4, Mask</pre>	<p>ARCH(7)</p>



Table 90. Built-in general-instruction prototypes (continued)

PROTOTYPE and Notes	Sample Pseudo Assembly	MIN ARCH
<pre>int __cu24(unsigned int *OP1, unsigned long op1_len, unsigned short *OP2, unsigned long op2_len, unsigned char mask)</pre> <p>Operands:</p> <ul style="list-style-type: none"> <li>• OP1 represents the first operand in the hardware instruction. OP1 points to the storage location for receiving the converted UTF-32 characters.</li> <li>• op1_len specifies the zero-based length of OP1, which is the number of additional bytes to the right of OP1. A length of 1 is represented by 0, a length of 2 is represented by 1, and so forth.</li> <li>• OP2 represents the second operand in the hardware instruction. OP2 points to the source UTF-16 characters.</li> <li>• op2_len specifies the zero-based length of OP2, which is the number of additional bytes to the right of OP2. A length of 1 is represented by 0, a length of 2 is represented by 1, and so forth.</li> <li>• mask specifies the mask encoded in the machine instruction; it must be a literal value of either 0 or 1.</li> </ul> <p><b>Note:</b> If option LP64 is specified, both op1_len and op2_len are 64-bit unsigned integers. Otherwise they are 32-bit unsigned integers.</p> <p>The return value is the condition code set by the CU24 instruction.  <b>Note:</b> When the condition code is 3, the condition is handled by the compiler-generated code.</p>	<pre>L R2, OP1 L R3, op1_len L R4, OP2 L R5, op2_len CU21 R2, R4, Mask</pre>	ARCH(7)
<pre>int __cu41(char *OP1, unsigned long op1_len, unsigned int *OP2, unsigned long op2_len, unsigned int **invalid_utf32)</pre> <p>Operands:</p> <ul style="list-style-type: none"> <li>• OP1 represents the first operand in the hardware instruction. OP1 points to the storage location for receiving the converted UTF-8 characters.</li> <li>• op1_len specifies the zero-based length of OP1, which is the number of additional bytes to the right of OP1. A length of 1 is represented by 0, a length of 2 is represented by 1, and so forth.</li> <li>• OP2 represents the second operand in the hardware instruction. OP2 points to the source UTF-32 characters.</li> <li>• op2_len specifies the zero-based length of OP2, which is the number of additional bytes to the right of OP2. A length of 1 is represented by 0, a length of 2 is represented by 1, and so forth.</li> <li>• invalid_utf32 points to a pointer field for receiving the address of the invalid UTF-32 character in the source when the condition code is "2".</li> </ul> <p><b>Note:</b> If option LP64 is specified, both op1_len and op2_len are 64-bit unsigned integers. Otherwise they are 32-bit unsigned integers. The return value is the condition code set by the CU41 instruction.  <b>Note:</b> When the condition code is 3, the condition is handled by the compiler-generated code.</p>	<pre>L R2, OP1 L R3, op1_len L R4, OP2 L R5, op2_len CU41 R2, R4 ST *invalid_utf32,R4</pre>	ARCH(7)

Table 90. Built-in general-instruction prototypes (continued)

PROTOTYPE and Notes	Sample Pseudo Assembly	MIN ARCH
<p>int __cu42(unsigned short *OP1, unsigned long op1_len, unsigned int *OP2, unsigned long op2_len, unsigned int **invalid_utf32)</p> <p>Operands:</p> <ul style="list-style-type: none"> <li>• OP1 represents the first operand in the hardware instruction. OP1 points to the storage location for receiving the converted UTF-16 characters.</li> <li>• op1_len specifies the zero-based length of OP1, which is the number of additional bytes to the right of OP1. A length of 1 is represented by 0, a length of 2 is represented by 1, and so forth.</li> <li>• OP2 represents the second operand in the hardware instruction. OP2 points to the source UTF-32 characters.</li> <li>• op2_len specifies the zero-based length of OP2, which is the number of additional bytes to the right of OP2. A length of 1 is represented by 0, a length of 2 is represented by 1, and so forth.</li> <li>• invalid_utf32 points to a pointer field for receiving the address of the invalid UTF-32 character in the source when the condition code is "2".</li> </ul> <p><b>Note:</b> If option LP64 is specified, both op1_len and op2_len are 64-bit unsigned integers. Otherwise they are 32-bit unsigned integers.</p> <p>The return value is the condition code set by the CU42 instruction.  <b>Note:</b> When the condition code is 3, the condition is handled by the compiler-generated code.</p>	<p>L R2, OP1  L R3, op1_len  L R4, OP2  L R5, op2_len  CU42 R2, R4  ST *invalid_utf32, R4</p>	<p>ARCH(7)</p>
<p>int __cvb(char *OP2)</p> <p>OP2 points to an 8-byte storage area that contains a valid packed-decimal value. The return value is the converted 32-bit signed binary integer.</p>	<p>CVB R1, OP2D(OP2X, OP2B)</p>	<p>ARCH(0)</p>
<p>long long __cvbg(char *OP2)</p> <p>Operands: OP2 points to a 16-byte storage area that contains a valid packed-decimal value.</p> <p>The return value is the converted 64-bit signed binary integer.</p>	<p>CVBG R1, OP2D(OP2X, OP2B)</p>	<p>ARCH(5)</p>
<p>void __cvd(int OP1, char *OP2)</p> <ul style="list-style-type: none"> <li>• OP1 is a 32-bit signed binary integer value that gets converted into a packed-decimal value.</li> <li>• OP2 points to an 8-byte storage area that receives the converted packed-decimal value.</li> </ul>	<p>CVD OP1, OP2D(OP2X, OP2B)</p>	<p>ARCH(0)</p>
<p>void __cvdg(long long OP1, char *OP2)</p> <p>Operands:</p> <ul style="list-style-type: none"> <li>• OP1 is a 64-bit signed binary integer value that gets converted into a packed-decimal value.</li> <li>• OP2 points to a 16-byte storage area that receives the converted packed-decimal value.</li> </ul>	<p>CVDG OP1, OP2D(OP2X, OP2B)</p>	<p>ARCH(5)</p>
<p>int __lad(int* OP1, int OP3, int* OP2)</p> <p><b>Notes:</b></p> <ul style="list-style-type: none"> <li>• Return value corresponds to the condition code set by LAA.</li> <li>• The location pointed to by OP2 must be word aligned for __lad. Otherwise, a specification exception is recognized.</li> </ul>	<p>L R3, OP3  LAA R1, R3, OP2D(OP2B)  ST R1, *OP1</p>	<p>ARCH(9)</p>

Table 90. Built-in general-instruction prototypes (continued)

PROTOTYPE and Notes	Sample Pseudo Assembly	MIN ARCH
int __ladg(long* OP1, long OP3, long* OP2) <b>Notes:</b> <ul style="list-style-type: none"> <li>Return value corresponds to the condition code set by LAAG.</li> <li>The location pointed to by OP2 must be double-word aligned for __ladg. Otherwise, a specification exception is recognized.</li> </ul>	LG R3, OP3 LAAG R1, R3, OP2D(OP2B) STG R1, *OP1	ARCH(9) with LP64
int __ladl(unsigned int* OP1, unsigned int OP3, unsigned int* OP2) <b>Notes:</b> <ul style="list-style-type: none"> <li>Return value corresponds to the condition code set by LAAL.</li> <li>The location pointed to by OP2 must be word aligned for __ladl. Otherwise, a specification exception is recognized.</li> </ul>	L R3, OP3 LAAL R1, R3, OP2D(OP2B) ST R1, *OP1	ARCH(9)
int __ladlg(unsigned long* OP1, unsigned long OP3, unsigned long* OP2) <b>Notes:</b> <ul style="list-style-type: none"> <li>Return value corresponds to the condition code set by LAALG.</li> <li>The location pointed to by OP2 must be double-word aligned for __ladlg. Otherwise, a specification exception is recognized.</li> </ul>	LG R3, OP3 LAALG R1, R3, Op2D(OP2B) STG R1, *OP1	ARCH(9) with LP64
int __lan(unsigned int* OP1, unsigned int OP3, unsigned int* OP2) <b>Notes:</b> <ul style="list-style-type: none"> <li>Return value corresponds to the condition code set by LAN.</li> <li>The location pointed to by OP2 must be word aligned for __lan. Otherwise, a specification exception is recognized.</li> </ul>	L R3, OP3 LAN R1, R3, OP2D(OP2B) ST R1, *OP1	ARCH(9)
int __lang(unsigned long* OP1, unsigned long OP3, unsigned long* OP2) <b>Notes:</b> <ul style="list-style-type: none"> <li>Return value corresponds to the condition code set by LANG.</li> <li>The location pointed to by OP2 must be double-word aligned for __lang. Otherwise, a specification exception is recognized.</li> </ul>	LG R3, OP3 LANG R1, R3, OP2D(OP2B) STG R1, *OP1	ARCH(9) with LP64
int __lao(unsigned int* OP1, unsigned int OP3, unsigned int* OP2) <b>Notes:</b> <ul style="list-style-type: none"> <li>Return value corresponds to the condition code set by LAO.</li> <li>The location pointed to by OP2 must be word aligned for __lao. Otherwise, a specification exception is recognized.</li> </ul>	L R3, OP3 LAO R1, R3, OP2D(OP2B) ST R1, *OP1	ARCH(9)
int __laog(unsigned long* OP1, unsigned long OP3, unsigned long* OP2) <b>Notes:</b> <ul style="list-style-type: none"> <li>Return value corresponds to the condition code set by LAOG.</li> <li>The location pointed to by OP2 must be double-word aligned for __laog. Otherwise, a specification exception is recognized.</li> </ul>	LG R3, OP3 LAOG R1, R3, OP2D(OP2B) STG R1, *OP1	ARCH(9) with LP64
int __lax(unsigned int* OP1, unsigned int OP3, unsigned int* OP2) <b>Notes:</b> <ul style="list-style-type: none"> <li>Return value corresponds to the condition code set by LAX.</li> <li>The location pointed to by OP2 must be word aligned for __lax. Otherwise, a specification exception is recognized.</li> </ul>	L R3, OP3 LAX R1, R3, OP2D(OP2B) ST R1, *OP1	ARCH(9)

Table 90. Built-in general-instruction prototypes (continued)

PROTOTYPE and Notes	Sample Pseudo Assembly	MIN ARCH
<p>int __laxg(unsigned long* OP1, unsigned long OP3, unsigned long* OP2)</p> <p><b>Notes:</b></p> <ul style="list-style-type: none"> <li>Return value corresponds to the condition code set by LAXG.</li> <li>The location pointed to by OP2 must be double-word aligned for __laxg. Otherwise, a specification exception is recognized.</li> </ul>	<p>LG R3, OP3 LAXG R1, R3, OP2D(OP2B) STG R1, *OP1</p>	ARCH(9) with LP64
<p>unsigned int __lccb(const void* OP2, unsigned short boundary)</p> <p>Operands:</p> <ul style="list-style-type: none"> <li>OP2 represents the second operand in the hardware instruction.</li> <li>boundary represents the boundary to encode in the hardware instruction. It must be a literal value of either 64, 128, 256, 512, 1024, 2048, or 4096.</li> </ul> <p>The return value is the first operand set by the LCBB instruction. The first operand contains the number of bytes to load from the second operand location without crossing the specified block boundary. If the number of bytes is greater than 16, sixteen is placed in the first operand.</p>	<p>LCBB R1, OP2D(OP2X, OP2B), BoundaryM</p>	ARCH(11)
<p>int __lpd(unsigned int* OP3, unsigned int* OP4, unsigned int* OP1, unsigned int* OP2)</p> <p><b>Notes:</b></p> <ul style="list-style-type: none"> <li>Return value corresponds to the condition code set by LPD.</li> <li>The locations pointed to by OP1 and OP2 must be word aligned for __lpd. Otherwise, a specification exception is recognized.</li> </ul>	<p>LPD R3, OP1D(OP1B), OP2D(OP2B) ST R3, *OP3 ST R4, *OP4</p>	ARCH(9)
<p>int __lpdg(unsigned long* OP3, unsigned long* OP4, unsigned long* OP1, unsigned long* OP2)</p> <p><b>Notes:</b></p> <ul style="list-style-type: none"> <li>Return value corresponds to the condition code set by LPDG.</li> <li>The locations pointed to by OP1 and OP2 must be double-word aligned for __lpdg. Otherwise, a specification exception is recognized.</li> </ul>	<p>LPDG R3, OP1D(OP1B), OP2D(OP2B) STG R3, *OP3 STG R4, *OP4</p>	ARCH(9) with LP64
<p>unsigned int __lrv(unsigned int *OP)</p> <p>The return value is the result.</p>	<p>LRV R1, OPD(OPX,OPR)</p>	ARCH(4)
<p>unsigned long __lrvg(unsigned long *OP)</p> <p>The return value is the result.</p>	<p>LRVG R1, OPD(OPX,OPR)</p>	ARCH(5) with LP64
<p>unsigned short __lrvh(unsigned short *OP)</p> <p>The return value is the result.</p>	<p>LRVH R1, OPD(OPX,OPR)</p>	ARCH(4)

Table 90. Built-in general-instruction prototypes (continued)

PROTOTYPE and Notes	Sample Pseudo Assembly	MIN ARCH
<p>int __mvcle(char *OP1, unsigned long op1_len, unsigned char OP2, char *OP3, unsigned long op3_len)</p> <p>Operands:</p> <ul style="list-style-type: none"> <li>• OP1 represents the first operand in the hardware instruction.</li> <li>• op1_len specifies the zero-based length of OP1, which is the number of additional bytes to the right of OP1. A length of 1 is represented by 0, a length of 2 is represented by 1, and so forth.</li> <li>• OP2 specifies the byte for padding the first operand on the right, in the event that it is shorter than the third operand.</li> <li>• OP3 represents the third operand in the hardware instruction.</li> <li>• op3_len specifies the zero-based length of OP3, which is the number of additional bytes to the right of OP3. A length of 1 is represented by 0, a length of 2 is represented by 1, and so forth.</li> </ul> <p><b>Note:</b> If the LP64 compiler option is in effect, the op1_len and op3_len operands are 64-bit unsigned integers. Otherwise, op1_len and op3_len are 32-bit unsigned integers. The return value is the condition code set by the MVCLE instruction.</p> <p><b>Note:</b> When the condition code is 3, the condition is handled by the compiler-generated code.</p>	<pre>L R2, OP1 L R3, op1_len L R4, OP3 L R5, op3_len MVCLE R2, R4, OP2D(OP2B)</pre>	<p>ARCH(2)</p>
<p>int __mvclu(unsigned short *OP1, unsigned long op1_len, unsigned short OP2, unsigned short *OP3, unsigned long op3_len)</p> <p>Operands:</p> <ul style="list-style-type: none"> <li>• OP1 represents the first operand in the hardware instruction.</li> <li>• op1_len specifies the zero-based length of OP1, which is the number of additional bytes to the right of OP1. A length of 1 is represented by 0, a length of 2 is represented by 1, and so forth.</li> <li>• OP2 specifies padding the first operand with 2 bytes if it is shorter than the third operand.</li> <li>• OP3 represents the third operand in the hardware instruction.</li> <li>• op3_len specifies the zero-based length of OP3, which is the number of additional bytes to the right of OP3. A length of 1 is represented by 0, a length of 2 is represented by 1, and so forth.</li> </ul> <p><b>Notes:</b></p> <ol style="list-style-type: none"> <li>1. If the operand values are odd numbers, a specification exception will be triggered by the hardware.</li> <li>2. If the LP64 compiler option is in effect, the op1_len and op3_len operands are 64-bit unsigned integers. Otherwise they are 32-bit unsigned integers.</li> </ol> <p>The return value is the condition code set by the MVCLU instruction.</p> <p><b>Note:</b> When the condition code is 3, the condition is handled by the compiler-generated code.</p>	<pre>L R2, OP1 L R3, op1_len L R4, OP3 L R5, op3_len MVCLU R2, R4, OP2D(OP2B)</pre>	<p>ARCH(6)</p>

Table 90. Built-in general-instruction prototypes (continued)

PROTOTYPE and Notes	Sample Pseudo Assembly	MIN ARCH
<p>int __nc (unsigned char *OP1, unsigned char *OP2, unsigned char len)</p> <p>Operands:</p> <ul style="list-style-type: none"> <li>Each operand is processed left to right. When the operands overlap, the result is obtained as if the operands were processed one byte at a time and each result byte were stored immediately after fetching the necessary operand bytes.</li> <li>len specifies the zero-based length of OP1 (or OP2), which is the number of additional bytes to the right of OP1 (or OP2). A length of 1 is represented by 0, a length of 2 is represented by 1, and so forth. len+1 equals the number of bytes to perform the AND operation on OP1 and OP2. len must be in the range of 0 to 255 inclusive.</li> </ul> <p>The return value is the condition code.</p>	<p>NC OP1D(len,OP1B), OP2D(OP2B)</p>	<p>ARCH(0)</p>
<p>int __oc (unsigned char *OP1, unsigned char *OP2, unsigned char len)</p> <p>Operands:</p> <ul style="list-style-type: none"> <li>Each operand is processed left to right. When the operands overlap, the result is obtained as if the operands were processed one byte at a time and each result byte were stored immediately after fetching the necessary operand bytes.</li> <li>len specifies the zero-based length of OP1 (or OP2), which is the number of additional bytes to the right of OP1 (or OP2). A length of 1 is represented by 0, a length of 2 is represented by 1, and so forth. len+1 equals the number of bytes to perform the OR operation on OP1 and OP2. len must be in the range of 0 to 255 inclusive.</li> </ul> <p>The return value is the condition code.</p>	<p>OC OP1D(len,OP1B), OP2D(OP2B)</p>	<p>ARCH(0)</p>

Table 90. Built-in general-instruction prototypes (continued)

PROTOTYPE and Notes	Sample Pseudo Assembly	MIN ARCH
<p>void __pack (unsigned char *OP1, unsigned char op1_len, unsigned char *OP2, unsigned char op2_len)</p> <p>Operands:</p> <ul style="list-style-type: none"> <li>The format of OP2 is changed from zoned to signed-packed-decimal, and the result is placed at OP1 location.</li> <li>OP2 is treated as having the zoned format. The numeric bits of each byte are treated as a digit. The zone bits are ignored, except the zone bits in the rightmost byte, which are treated as a sign.</li> <li>The sign and digits are moved unchanged to OP1 and are not checked for valid codes. The sign is placed in the rightmost four bit positions of the rightmost byte of the result field, and the digits are placed adjacent to the sign and to each other in the remainder of the result field.</li> <li>The result is obtained as if the operands were processed right to left. When necessary, OP2 is considered to be extended on the left with zeros. If OP1 field is too short to contain all digits of OP2, the remaining leftmost portion of OP2 is ignored. Access exceptions for the unused portion of OP2 may or may not be indicated.</li> <li>op1_len specifies the zero-based length of OP1, which is the number of additional bytes to the right of OP1. A length of 1 is represented by 0, a length of 2 is represented by 1, and so forth. op1_len must be in the range of 0 to 15 inclusive.</li> <li>op2_len specifies the zero-based length of OP2, which is the number of additional bytes to the right of OP2. A length of 1 is represented by 0, a length of 2 is represented by 1, and so forth. op2_len must be in the range of 0 to 15 inclusive.</li> </ul>	<p>PACK OP1D(op1_len,OP1B), OP2D(op2_len,OP2B)</p>	<p>ARCH(0)</p>
<p>void __pka(char *OP1, char *OP2, unsigned char op2_len)</p> <ul style="list-style-type: none"> <li>OP1 points to a 16-byte storage area. The packed string is stored in the storage addressed by OP1.</li> <li>OP2 points to an ASCII string to be packed by the operation.</li> <li>op2_len specifies the zero-based length of OP2, which is the number of additional bytes to the right of OP2. A length of 1 is represented by 0, a length of 2 is represented by 1, and so forth.</li> </ul> <p><b>Notes:</b></p> <ol style="list-style-type: none"> <li>If op2_len is not between 0 and 31, a specification exception will be triggered by the hardware.</li> <li>If op2_len is not a literal, the compiler will issue an EX instruction that executes a target PKA instruction with op2_len encoded in the register used by the EX instruction.</li> </ol>	<p>PKA OP1D(OP1B), OP2D(op2_len, OP2B)</p>	<p>ARCH(6)</p>
<p>void __pku(char *OP1, unsigned short *OP2, unsigned char op2_len)</p> <ul style="list-style-type: none"> <li>OP1 points to a 16-byte storage area. The packed string is stored in the storage addressed by OP1.</li> <li>OP2 points to Unicode Basic Latin character string to be packed by the operation.</li> <li>op2_len specifies the zero-based length of OP2, which is the number of additional bytes to the right of OP2. A length of 1 is represented by 0, a length of 2 is represented by 1, and so forth.</li> </ul> <p><b>Notes:</b></p> <ol style="list-style-type: none"> <li>If op2_len is not an odd number between 0 and 63, a specification exception will be triggered by the hardware.</li> <li>If op2_len is not a literal, the compiler will issue an EX instruction that executes a target PKU instruction with op2_len encoded in the register used by the EX instruction.</li> </ol>	<p>PKU OP1D(OP1B), OP2D(op2_len, OP2B)</p>	<p>ARCH(6)</p>

Table 90. Built-in general-instruction prototypes (continued)

PROTOTYPE and Notes	Sample Pseudo Assembly	MIN ARCH
<p>unsigned long __popcnt(unsigned long OP)</p> <p>The population count instruction counts the number of bits set in each byte of a register. It then sets the corresponding byte of the result register to reflect the count.</p> <p>The instruction operates on all 64-bits of a register and thus clobbers the upper half of a register in 32-bit mode. Volatile registers R0, R1, or R15 are used for the instruction in 32-bit mode with NOHGPR.</p>	POPCNT R1, OP	ARCH(9)
<p>int __srstu (unsigned short *OP1, unsigned short *OP2, unsigned short pattern, unsigned short **found_char)</p> <p>Operands:</p> <ul style="list-style-type: none"> <li>• OP1 represents the first operand in the hardware instruction, it points at the first 2-byte character after the end of the second operand.</li> <li>• OP2 represents the second operand in the hardware instruction, it points at the start of a 2-byte character string.</li> <li>• pattern is the 2-byte character to be searched for.</li> <li>• found_char points to a pointer field for receiving the address of the 2-byte character that was found in the second operand.</li> </ul> <p>The return value is the condition code set by the SRSTU instruction.  <b>Note:</b> When the condition code is 3, the condition is handled by the compiler-generated code.</p>	<pre>L GR0, pattern L R1, OP1 SRSTU R1, OP2 ST *found_char, R1</pre>	ARCH(7)
<p>int __stck(unsigned long long *OP1)</p> <p>The return value is the condition code.</p>	STCK Op1D(OP1B)	ARCH(0)
<p>int __stcke(void *OP1)</p> <p>The return value is the condition code.</p>	STCKE Op1D(OP1B)	ARCH(4)
<p>int __stckf(unsigned long long *OP1)</p> <p>The return value is the condition code.</p>	STCKF Op1D(OP1B)	ARCH(7)
<p>void __strv(unsigned int OP1, unsigned int *OP2)</p>	STRV R1, OP2D(OP2X,OP2R)	ARCH(4)
<p>void __strvg(unsigned long OP1, unsigned long *OP2)</p>	STRVG R1, OP2D(OP2X,OP2R)	ARCH(5) with LP64
<p>void __strvh(unsigned short OP1, unsigned short *OP2)</p>	STRVH R1, OP2D(OP2X,OP2R)	ARCH(4)



Table 90. Built-in general-instruction prototypes (continued)

PROTOTYPE and Notes	Sample Pseudo Assembly	MIN ARCH
<p>void __tr (unsigned char *OP1, const unsigned char *OP2, unsigned char len)</p> <p>Operands:</p> <ul style="list-style-type: none"> <li>• The bytes of OP1 are used as eight-bit arguments to reference a list designated by the address of OP2. Each function byte selected from the list replaces the corresponding argument in OP1.</li> <li>• len specifies the zero-based length of OP1, which is the number of additional bytes to the right of OP1. A length of 1 is represented by 0, a length of 2 is represented by 1, and so forth. len must be in the range of 0 to 255 inclusive.</li> <li>• The bytes of OP1 are selected one by one for translation, proceeding left to right. Each argument byte is added to the initial OP2 address. The addition is performed following the rules for address arithmetic, with the argument byte treated as an eight-bit unsigned binary integer and extended with zeros on the left. The sum is used as the address of the function byte, which then replaces the original argument byte.</li> <li>• The operation proceeds until the OP1 field is exhausted. The list is not altered unless an overlap occurs.</li> <li>• When the operands overlap, the result is obtained as if each result byte were stored immediately after fetching the corresponding function byte.</li> </ul>	<p>TR OP1D(len,OP1B), OP2D(OP2B)</p>	<p>ARCH(0)</p>
<p>int __tre(char *OP1, unsigned long op1_len, char *OP2, unsigned char test_char)</p> <p>Operands:</p> <ul style="list-style-type: none"> <li>• OP1 represents the first operand in the hardware instruction. It points to the byte string that needs to be translated.</li> <li>• op1_len specifies the zero-based length of OP1, which is the number of additional bytes to the right of OP1. A length of 1 is represented by 0, a length of 2 is represented by 1, and so forth.</li> </ul> <p><b>Note:</b> If the LP64 compiler option is in effect, the op1_len operand is a 64-bit unsigned integer. Otherwise it is a 32-bit unsigned integer.</p> <ul style="list-style-type: none"> <li>• OP2 represents the second operand in the hardware instruction. It points to a 256-byte translation table.</li> <li>• test_char specifies the terminating character in the first operand for stopping the operation.</li> </ul> <p>The return value is the condition code set by the TRE instruction. <b>Note:</b> When the condition code is 3, the condition is handled by the compiler-generated code.</p>	<p>TRE R1, OP2</p>	<p>ARCH(5)</p>

Table 90. Built-in general-instruction prototypes (continued)

PROTOTYPE and Notes	Sample Pseudo Assembly	MIN ARCH
<p>int __troo (char *OP1, char *OP2, unsigned long op2_len, char *tr_table, unsigned char test_char, unsigned char mask)</p> <p>Operands:</p> <ul style="list-style-type: none"> <li>• OP1 represents the first operand in the hardware instruction.</li> <li>• OP2 represents the second operand in the hardware instruction.</li> <li>• op2_len specifies the zero-based length of OP2, which is the number of additional bytes to the right of OP2. A length of 1 is represented by 0, a length of 2 is represented by 1, and so forth. <b>Note:</b> If option LP64 is specified, op2_len is a 64-bit unsigned integer and the length of the first operand is considered the same as that of the second operand. If option LP64 is not specified, both operands are 32-bit unsigned integers.</li> <li>• tr_table points to a 256-byte translation table on a double-word boundary. <b>Note:</b> It is the user's responsibility to provide a double-word aligned translation table.</li> <li>• test_char specifies a 1-byte function character that can be coded in the translation table for stopping the operation.</li> <li>• mask specifies the mask encoded in the machine instruction; it must be a literal value of either 0 or 1.</li> </ul> <p>The return value is the condition code set by the TROO instruction. <b>Note:</b> When the condition code is 3, the condition is handled by the compiler-generated code.</p>	<pre>L GR0, test_char L GR1, tr_table L R2, OP1 L R3, op2_len TROO R2, OP2, Mask</pre>	<p>ARCH(7)</p>
<p>int __trot(unsigned short *OP1, char *OP2, unsigned long op2_len, char *tr_table, unsigned short test_char, unsigned char mask)</p> <p>Operands:</p> <ul style="list-style-type: none"> <li>• OP1 represents the first operand in the hardware instruction.</li> <li>• OP2 represents the second operand in the hardware instruction.</li> <li>• op2_len specifies the zero-based length of OP2, which is the number of additional bytes to the right of OP2. A length of 1 is represented by 0, a length of 2 is represented by 1, and so forth. <b>Note:</b> If option LP64 is specified, op2_len is a 64-bit unsigned integer and the length of the first operand is considered the same as that of the second operand. Otherwise, both operands are 32-bit unsigned integers.</li> <li>• tr_table points to a 512-byte translation table on a double-word boundary. <b>Note:</b> It is the user's responsibility to provide a double-word aligned translation table.</li> <li>• test_char specifies a 2-byte function character that can be coded in the translation table for stopping the operation.</li> <li>• mask specifies the mask encoded in the machine instruction; it must be a literal value of either 0 or 1.</li> </ul> <p>The return value is the condition code set by the TRTO instruction. <b>Note:</b> When the condition code is 3, the condition is handled by the compiler-generated code.</p>	<pre>L GR0, test_char L GR1, tr_table L R2, OP1 L R3, op2_len TROT R2, OP2, Mask</pre>	<p>ARCH(7)</p>

Table 90. Built-in general-instruction prototypes (continued)

PROTOTYPE and Notes	Sample Pseudo Assembly	MIN ARCH
<p>int __trto(char *OP1, unsigned short *OP2, unsigned long op2_len, char *tr_table, char test_char, unsigned char mask)</p> <p>Operands:</p> <ul style="list-style-type: none"> <li>• OP1 represents the first operand in the hardware instruction.</li> <li>• OP2 represents the second operand in the hardware instruction.</li> <li>• op2_len specifies the zero-based length of OP2, which is the number of additional bytes to the right of OP2. A length of 1 is represented by 0, a length of 2 is represented by 1, and so forth. <b>Note:</b> If option LP64 is specified, op2_len is an 64-bit unsigned integer. If option LP64 is not specified, op2_len is an 32-bit unsigned integer.</li> <li>• tr_table points to a 64-KB translation table on a double-word boundary. <b>Note:</b> It is the user's responsibility to provide a double-word aligned translation table.</li> <li>• test_char specifies a 1-byte function character, that can be coded in the translation table, for stopping the operation.</li> <li>• mask specifies the mask encoded in the machine instruction; it must be a literal value of either 0 or 1.</li> </ul> <p>The return value is the condition code set by the TROT instruction. <b>Note:</b> When the condition code is 3, the condition is handled by the compiler-generated code.</p>	<pre>L GR0, test_char L GR1, tr_table L R2, OP1 L R3, op2_len TRTO R2, OP2, Mask</pre>	<p>ARCH(7)</p>
<p>int __trt (unsigned char *OP1, const unsigned char *OP2, unsigned char len, unsigned char *R2, unsigned char **R1)</p> <p>Operands:</p> <ul style="list-style-type: none"> <li>• The bytes of OP1 are used as eight-bit arguments to select function bytes from a list designated by the address of OP2. The first nonzero function byte is inserted in general register 2, and the related argument address in general register 1.</li> <li>• len specifies the zero-based length of OP1, which is the number of additional bytes to the right of OP1. A length of 1 is represented by 0, a length of 2 is represented by 1, and so forth. len must be in the range of 0 to 255 inclusive.</li> <li>• The bytes of OP1 are selected one by one for translation, proceeding left to right. OP1 remains unchanged in storage. Calculation of the address of the function byte is performed as in the __tr instruction. The function byte retrieved from the list is inspected for a value of zero.</li> <li>• When the function byte is zero, the operation proceeds with the next byte of OP1.</li> <li>• When the function byte is nonzero, the operation is completed by inserting the function byte in general register 2 and the related argument address in general register 1. Either condition code 1 or 2 is set, depending on whether the argument byte is the rightmost byte of OP1. Condition code 1 is set if one or more argument bytes remain to be translated. Condition code 2 is set if no more argument bytes remain.</li> </ul> <p>The return value is the condition code.</p>	<pre>TRT OP1D(len,OP1B), OP2D(OP2B)</pre>	<p>ARCH(0)</p>

Table 90. Built-in general-instruction prototypes (continued)

PROTOTYPE and Notes	Sample Pseudo Assembly	MIN ARCH
<p>int __trtr (unsigned char *OP1, const unsigned char *OP2, unsigned char len, unsigned char *R2, unsigned char **R1)</p> <p>Operands:</p> <ul style="list-style-type: none"> <li>• OP1 represents the first operand in the hardware instruction; it points to the last byte of the byte string to be translated and tested.</li> <li>• OP2 represents the second operand in the hardware instruction; it points to a 256-byte table.</li> <li>• len specifies the zero-based length of OP1, which is the number of additional bytes to the right of OP1. A length of 1 is represented by 0, a length of 2 is represented by 1, and so forth. len must be in the range of 0 to 255 inclusive.</li> </ul> <p><b>Note:</b> When len is not specified as a literal, an EX instruction is generated to execute a target TRTR instruction with len encoded in the register used by the EX instruction.</p> <ul style="list-style-type: none"> <li>• R2 points to a one-byte storage for receiving the function byte in GPR 2 when the condition code is nonzero.</li> <li>• R1 points to a pointer field for receiving the address in GPR 1 when the condition code is nonzero.</li> </ul> <p>The return value is the condition code set by the TRTR instruction.</p>	<pre>TRTR OP1D(len, OP1B), OP2D(OP2B) ST *R2, GR2 ST *R1, GR1</pre>	<p>ARCH(7)</p>
<p>int __trtt(unsigned short *OP1, unsigned short *OP2, unsigned long op2_len, char*tr_table, unsigned short test_char, unsigned char mask)</p> <p>Operands:</p> <ul style="list-style-type: none"> <li>• OP1 represents the first operand in the hardware instruction.</li> <li>• OP2 represents the second operand in the hardware instruction.</li> <li>• op2_len specifies the zero-based length of OP2, which is the number of additional bytes to the right of OP2. A length of 1 is represented by 0, a length of 2 is represented by 1, and so forth.</li> </ul> <p><b>Note:</b> If option LP64 is specified, op2_len is a 64-bit unsigned integer and the length of the first operand is considered the same as that of the second operand. Otherwise, both operands are 32-bit unsigned integers.</p> <ul style="list-style-type: none"> <li>• tr_table points to a 128-KB translation table on a double-word boundary.</li> <li>• test_char specifies a 2-byte function character that can be coded in the translation table for stopping the operation.</li> <li>• mask specifies the mask encoded in the machine instruction; it must be a literal value of either 0 or 1.</li> </ul> <p>The return value is the condition code set by the TRTT instruction.</p> <p><b>Note:</b> When the condition code is 3, the condition is handled by the compiler-generated code.</p>	<pre>L GR0, test_char L GR1, tr_table L R2, OP1 L R3, op2_len TRTT R2, OP2, Mask</pre>	<p>ARCH(7)</p>

Table 90. Built-in general-instruction prototypes (continued)

PROTOTYPE and Notes	Sample Pseudo Assembly	MIN ARCH
<p>void __unpk (unsigned char *OP1, unsigned char op1_len, unsigned char *OP2, unsigned char op2_len)</p> <p>Operands:</p> <ul style="list-style-type: none"> <li>The format of OP2 is changed from signed-packed-decimal to zoned, and the result is placed at OP1 location.</li> <li>OP2 is treated as having the signed-packed-decimal format. Its digits and sign are placed unchanged in OP1 location, using the zoned format. Zone bits with coding of 1111 are supplied for all bytes except the rightmost byte, the zone of which receives the sign of OP2. The sign and digits are not checked for valid codes.</li> <li>The result is obtained as if the operands were processed right to left. When necessary, OP2 is considered to be extended on the left with zeros. If OP1 field is too short to contain all digits of OP2, the remaining leftmost portion of OP2 is ignored. Access exceptions for the unused portion of OP2 may or may not be indicated.</li> <li>op1_len specifies the zero-based length of OP1, which is the number of additional bytes to the right of OP1. A length of 1 is represented by 0, a length of 2 is represented by 1, and so forth. op1_len must be in the range of 0 to 15 inclusive.</li> <li>op2_len specifies the zero-based length of OP2, which is the number of additional bytes to the right of OP2. A length of 1 is represented by 0, a length of 2 is represented by 1, and so forth. op2_len must be in the range of 0 to 15 inclusive.</li> </ul>	<p>UNPK OP1D(op1_len,OP1B), OP2D(op2_len,OP2B)</p>	<p>ARCH(0)</p>
<p>int __unpka(char *OP1, unsigned char op1_len, char *OP2);</p> <p>Operands:</p> <ul style="list-style-type: none"> <li>OP1 points to a maximum 32-byte storage area to receive the unpacked data from the second operand.</li> <li>op1_len specifies the length encoded in the machine instruction (that is, the number of additional bytes to the right of the first operand). <b>Note:</b> If op1_len is not a literal, the compiler will issue an EX instruction that executes a target UNPKA instruction with op1_len encoded in the register used by the EX instruction.</li> <li>OP2 points to a 16-byte data string that represents 31 digits and a sign.</li> </ul> <p>The return value is the condition code set by the UNPKA instruction.</p>	<p>UNPKA OP1D(op1_len, OP1B), OP2D(OP2B)</p>	<p>ARCH(6)</p>
<p>int __unpku(unsigned short *OP1, unsigned char op1_len, char *OP2);</p> <p>Operands:</p> <ul style="list-style-type: none"> <li>OP1 points to a maximum 64-byte storage area to receive the unpacked data from the second operand.</li> <li>op1_len specifies the zero-based length of OP1, which is the number of additional bytes to the right of OP1. A length of 1 is represented by 0, a length of 2 is represented by 1, and so forth. <b>Notes:</b> <ol style="list-style-type: none"> <li>If op1_len is not a literal, the compiler will issue an EX instruction that executes a target UNPKU instruction with op1_len encoded in the register used by the EX instruction.</li> <li>If op1_len is not an odd number between 0 and 63, a specification exception will be triggered by the hardware.</li> </ol> </li> <li>OP2 points to a 16-byte data string that represents 31 digits and a sign.</li> </ul> <p>The return value is the condition code set by the UNPKU instruction.</p>	<p>UNPKU OP1D(op1_len, OP1B), OP2D(OP2B)</p>	<p>ARCH(6)</p>

Table 90. Built-in general-instruction prototypes (continued)

PROTOTYPE and Notes	Sample Pseudo Assembly	MIN ARCH
<pre>int __xc (unsigned char *OP1, unsigned char *OP2, unsigned char len)</pre> <p>Operands:</p> <ul style="list-style-type: none"> <li>Each operand is processed left to right. When the operands overlap, the result is obtained as if the operands were processed one byte at a time and each result byte were stored immediately after fetching the necessary operand bytes.</li> <li>len specifies the zero-based length of OP1 (or OP2), which is the number of additional bytes to the right of OP1 (or OP2). A length of 1 is represented by 0, a length of 2 is represented by 1, and so forth. len+1 equals the number of bytes to perform the XOR operation on OP1 and OP2. len must be in the range of 0 to 255 inclusive.</li> </ul> <p>The return value is the condition code.</p>	<pre>XC OP1D(len,OP1B), OP2D(OP2B)</pre>	<pre>ARCH(0)</pre>

## PLO - Perform Locked Operation available in ARCH(5)

With the PLO instruction, you can perform the following atomic read-modify-write operations:

- compare and load
- compare and swap
- double compare and swap
- compare swap and store
- compare swap and double store
- compare swap and triple store

To perform a particular operation, the PLO requires an address to a lock, a function code that specifies the operation to be performed and the relevant operands. Each PLO operation has four built-in functions associated with it. The functions take 32-bit, 64-bit, and 128-bit operands. Applications written with built-ins that take 64-bit or 128-bit operands need to be compiled and linked with LP64 option. In other words, PLO built-ins that end with the letter G, GR(64-bit operands), or X(128 bit operands) need to be compiled with LP64 option. For example, for the "compare and load" interface, the functions `__plo_CLGR`, `__plo_CLG`, and `__plo_CLX` need to be compiled with LP64 option.

The function prototypes, associated types, and helper macros will be declared in `builtins.h` header file. The argument names and order in the function prototypes attempt to reflect the description of the hardware instructions in *z/Architecture Principles of Operation*. A brief description is provided for each function prototype, data types, and helper macros.

**Note:** For every 8-byte PLO operation, there are two interfaces, for example, `__plo_DSCG` and `__plo_DCSGR`. The distinction between these two prototypes is that the former uses a parameter list to receive all its arguments.

All the atomic read-modify-write operations require a memory location, which is to be used as a lock and is the first argument for all the prototypes. The return type for all the functions is a signed integer, which returns the condition code set by the PLO instruction.

**Note:** There is no AR mode support. You need to enable support for the unsigned long long type to use the PLO interface. You also need to enable 64 bit mode compilation when using PLO built-ins that take 64-bit or 128-bit operands.

### Associated types and helper macros

For certain function codes, the PLO instruction takes the address to a parameter list that contains all the operands needed to perform the specified operation. The parameter list is a contiguous region in memory where the operands are stored. The parameter list has to be double word aligned, and for each atomic operation the layout of the operands in the list is different. All unused fields in the parameter list have to contain zeros.

To simplify the setup of the parameter list, an interface is provided to setup the parameter list prior to passing it to any of the built-in functions. The macros and the types are defined in `builtins.h` header file.

```
#define __PLO_PARAM_LIST_MAX_SIZE 18

typedef unsigned long long __plo_plist[ __PLO_PARAM_LIST_MAX_SIZE ]

//Compare and Load
#define __PLO_CL 0
#define __PLO_CLG 1
#define __PLO_CLGR 2
#define __PLO_CLX 3

//Compare and Swap
#define __PLO_CS 4
#define __PLO_CSG 5
#define __PLO_CSGR 6
#define __PLO_CSX 7

//Double Compare and Swap
#define __PLO_DCS 8
#define __PLO_DCSTG 9
#define __PLO_DCSTGR 10
#define __PLO_DCSX 11

//Compare Swap and Store
#define __PLO_CSST 12
#define __PLO_CSSTG 13
#define __PLO_CSSTGR 14
#define __PLO_CSSTX 15

//Compare Swap and Double Store
#define __PLO_CSDST 16
#define __PLO_CSDSTG 17
#define __PLO_CSDSTGR 18
#define __PLO_CSDSTX 19

//Compare Swap and Triple Store
#define __PLO_CSTST 20
#define __PLO_CSTSTG 21
#define __PLO_CSTSTGR 22
#define __PLO_CSTSTX 23
```

An array of fixed size is defined to correspond to the largest size the parameter list can have, and various function codes are defined.

Table 91 on page 525 describes the helper macros.

Table 91. PLO helper macros

Helper Macros	Description
<code>__PLO_INIT_PARAM_LIST(param_list)</code>	Helper macro to initialize the parameter list and must be called prior to loading the parameter list with any values.
<code>__PLO_PUTVAL_PARAM_LIST4(function_code, param_list, uint_op1c, uint_op1r, uint_op3, uint_op4_ptr, uint_op5, uint_op6_ptr, uint_op7, uint_op8_ptr)</code>	Helper macro to setup the parameter list for read-modify write operations on 32 bit operands. The macro takes the function code for the operation that will be performed on the parameter list, a superset of the operands that might be required and the parameter list itself.
<code>__PLO_PUTVAL_PARAM_LIST8(function_code, param_list, ulonglong_op1c, ulonglong_op1r, ulonglong_op3, ulonglong_op3c, ulonglong_op3r, ulonglong_op4_ptr, ulonglong_op5, ulonglong_op6_ptr, ulonglong_op7, ulonglong_op8_ptr)</code>	Helper macro to setup the parameter list for read-modify write operations on 64-bit operands.
<code>__PLO_PUTVAL_PARAM_LIST16(function_code, param_list, ulonglong_op1c_ptr, ulonglong_op1r_ptr, ulonglong_op3_ptr, ulonglong_op3c_ptr, ulonglong_op3r_ptr, ulonglong_op4_ptr, ulonglong_op5_ptr, ulonglong_op6_ptr, ulonglong_op7_ptr, ulonglong_op8_ptr)</code>	Helper macro to setup the parameter list for 128 bit operands. Note that for 128 bit operands, pointers are taken to a 16 byte region in memory as arguments.
<code>__PLO_GETVAL_PARAM_LIST8(function_code, param_list, ulonglong_op1c, ulonglong_op3, ulonglong_op3c)</code>	Helper macro to read 64-bit values that are updated by the execution of a PLO operation from the parameter list.
<code>__PLO_GETVAL_PARAM_LIST16(function_code, param_list, ulonglong_op1c_ptr, ulonglong_op3_ptr, ulonglong_op3c_ptr)</code>	Helper macro to read 128-bit values that are updated by the execution of a PLO operation from the parameter list.



## Compare and Load

Table 92 describes the prototypes for compare and load operations.

Table 92. Compare and load prototypes

PROTOTYPE and Notes	Sample Pseudo Assembly	MIN ARCH
<pre>int __plo_CL(void * lock,             unsigned int * op1c,             unsigned int * op2,             unsigned int * op3,             unsigned int * op4); int __plo_CLGR(void * lock,               unsigned long long * op1c,               unsigned long long * op2,               unsigned long long * op3,               unsigned long long * op4);</pre>	<pre>L GR1, lock L GR0, function_code(0 or 2) L R1, *op1c L R3, *op3 PLO R1, R3, op2, op4 ST *op3, R3 ST *op1c, R1</pre>	ARCH(5)
<pre>int __plo_CLG (void * lock,               unsigned long long* op2,               void * param_list); int __plo_CLX (void * lock,               void* op2,               void * param_list);</pre> <p><b>Note:</b> "void * param_list" is a pointer to the parameter list that is discussed in section <b>Associated types and helper macros</b>.</p>	<pre>L GR1, lock L GR0, function_code(1 or 3) PLO op2, param_list</pre>	ARCH(5)

## Compare and Swap

Table 93 describes the prototypes for compare and swap operations.

Table 93. Compare and swap prototypes

PROTOTYPE and Notes	Sample Pseudo Assembly	MIN ARCH
<pre>int __plo_CS(void * lock,             unsigned int * op1c,             unsigned int oplr,             unsigned int * op2); int __plo_CSGR(void * lock,               unsigned long long * op1c,               unsigned long long oplr,               unsigned long long * op2);</pre>	<pre>L GR1, lock L GR0, function_code (4 or 6) L R1, *op1c L R1+1, oplr PLO R1, op2 ST R1, *op1c</pre>	ARCH(5)
<pre>int __plo_CSG (void * lock,               unsigned long long * op2,               void * param_list); int __plo_CSX(void * lock,               void * op2,               void * param_list);</pre> <p><b>Note:</b> "void * param_list" is a pointer to the parameter list that is discussed in section <b>Associated types and helper macros</b>.</p>	<pre>L GR1, lock L GR0, function_code (5 or 7) PLO op2, param_list</pre>	ARCH(5)

## Double Compare and Swap

Table 94 on page 527 describes the prototypes for double compare and swap operations.

Table 94. Double compare and swap prototypes

PROTOTYPE and Notes	Sample Pseudo Assembly	MIN ARCH
<pre>int __plo_DCS(void * lock,              unsigned int * op1c,              unsigned int oplr,              unsigned int * op2,              unsigned int * op3c,              unsigned int op3r,              unsigned int * op4);  int __plo_DCSGR(void * lock,                unsigned long long * op1c,                unsigned long long oplr,                unsigned long long * op2,                unsigned long long * op3c,                unsigned long long op3r,                unsigned long long * op4);</pre>	<pre>L GR1, lock L GR0, function_code (8 or 10) L R1, *op1c L R1+1, oplr L R3, *op3c L R3+1, op3r PLO R1,R3, op2,op4 ST R1, *op1c ST R3, *op3c</pre>	ARCH(5)
<pre>int __plo_DCSG(void * lock,               unsigned long long * op2,               void * param_list);  int __plo_DCSX(void * lock,               void * op2,               void * param_list);</pre> <p><b>Note:</b> "void * param_list" is a pointer to the parameter list that is discussed in section <b>Associated types and helper macros</b>.</p>	<pre>L GR1, lock L GR0, function_code (9 or 11) PLO op2, param_list</pre>	ARCH(5)

## Compare and Swap and Store

Table 95 describes the prototypes for compare and swap and store operations.

Table 95. Compare and swap and store prototypes

PROTOTYPE and Notes	Sample Pseudo Assembly	MIN ARCH
<pre>int __plo_CSST (void * lock,               unsigned int * op1c,               unsigned int oplr,               unsigned int * op2,               unsigned int op3,               unsigned int * op4);  int __plo_CSSTGR (void * lock,                 unsigned long long * op1c,                 unsigned long long oplr,                 unsigned long long * op2,                 unsigned long long op3,                 unsigned long long * op4);</pre>	<pre>L GR1, lock L GR0, function_code (12 or 14) L R1, *op1c L R1+1, oplr L R3, op3 PLO R1,R3,op2,op4 ST R1, *op1c</pre>	ARCH(5)
<pre>int __plo_CSSTG (void * lock,                 unsigned long long * op2,                 void * param_list);  int __plo_CSSTX (void * lock,                 void * op2,                 void * param_list);</pre> <p><b>Note:</b> "void * param_list" is a pointer to the parameter list that is discussed in section <b>Associated types and helper macros</b>.</p>	<pre>L GR1, lock L GR0, function_code (13 or 15) PLO op2, param_list</pre>	ARCH(5)

## Compare Swap and Double Store

Table 96 on page 528 describes the prototypes for compare, swap, and double store operations.

Table 96. Compare swap and double store prototypes

PROTOTYPE and Notes	Sample Pseudo Assembly	MIN ARCH
<pre>int __plo_CSDST (void * lock,                 unsigned int * oplc,                 unsigned int oplr,                 unsigned int * op2,                 void * param_list); int __plo_CSDSTGR(void * lock,                  unsigned long long * oplc,                  unsigned long long oplr,                  unsigned long long * op2,                  void * param_list);</pre>	<pre>L GR1, lock L GR0, function_code (16 or 18) L R1, *oplc L R1+1, oplr PLO R1, op2, param_list ST R1, *oplc</pre>	ARCH(5)
<pre>int __plo_CSDSTG (void * lock,                  unsigned long long * op2,                  void * param_list); int __plo_CSDSTX(void * lock,                  void * op2,                  void * param_list);</pre> <p><b>Note:</b> "void * param_list" is a pointer to the parameter list that is discussed in section <b>Associated types and helper macros</b>.</p>	<pre>L GR1, lock L GR0, function_code (17 or 19) PLO op2, param_list</pre>	ARCH(5)

## Compare and Swap and Triple Store

Table 97 describes the prototypes for compare and swap and triple store operations.

Table 97. Compare and swap and triple store prototypes

PROTOTYPE and Notes	Sample Pseudo Assembly	MIN ARCH
<pre>int __plo_CSTST (void * lock,                 unsigned int * oplc,                 unsigned int oplr,                 unsigned int * op2,                 void * param_list); int __plo_CSTSTGR(void * lock,                  unsigned long long * oplc,                  unsigned long long oplr,                  unsigned long long * op2,                  void * param_list);</pre>	<pre>L GR1, lock L GR0, function_code (20 or 22) L R1, *oplc L R1+1, oplr PLO R1, op2, param_list ST R1, *oplc</pre>	ARCH(5)
<pre>int __plo_CSTSTG (void * lock,                  unsigned long long * op2,                  void * param_list); int __plo_CSTSTX (void * lock,                  void * op2,                  void * param_list);</pre> <p><b>Note:</b> "void * param_list" is a pointer to the parameter list that is discussed in section <b>Associated types and helper macros</b>.</p>	<pre>L GR1, lock L GR0, function_code (21 or 23) PLO op2, param_list</pre>	ARCH(5)

## Decimal instructions

Hardware packed-decimal instructions are available to C/C++ programs in the form of built-in functions. These hardware built-in functions are intended to provide access to decimal instructions that are not normally generated by the compiler.

Decimal instructions of SS format carry one or two length fields. Each length field is encoded with a binary length, that is the actual length - 1. In the function prototypes, the length parameters need to be specified as the actual length - 1. Argument names and order reflects the description of the hardware instructions in *z/Architecture Principles of Operation* (that is, op1, op2, op3, etc.) Additional arguments provide required information for setting up the actual hardware instruction. For detailed description of each decimal instruction, see *Chapter 8. Decimal Instructions of the z/Architecture Principles of Operation*.

If you want to use any of the decimal functions, your program must include `builtins.h` and be compiled with either the `LANGLVL(EXTENDED)` option or the `LANGLVL(LIBEXT)` option.

Table 98. Decimal instruction prototypes

PROTOTYPE and Notes	Sample Pseudo Assembly	MIN ARCH
<pre>int __ap (unsigned char *op1, unsigned char len1, unsigned char *op2, unsigned char len2 );</pre> <p>Operands:</p> <ul style="list-style-type: none"> <li>• op1 represents the first operand in the hardware instruction. It points to the first operand location. The result replaces the first operand.</li> <li>• len1 specifies the length encoded in the machine instruction (that is, the number of additional bytes to the left of the first operand). The value is between 0 and 15.</li> <li>• op2 represents the second operand in the hardware instruction. It points to the second operand location.</li> <li>• len2 specifies the length encoded in the machine instruction (that is, the number of additional bytes to the left of the second operand). The value is between 0 and 15.</li> </ul> <p><b>Note:</b> When either len1 or len2 is not specified as a literal, an EX instruction is generated to execute a target AP instruction with length encoded in the register used by the EX instruction.</p> <p>The return value is the condition code set by the AP instruction.</p>	<pre>AP Op1D(len1, Op1B), Op2D(len2, Op2B)</pre>	ARCH(0)
<pre>int __cp (unsigned char *op1, unsigned char len1, unsigned char *op2, unsigned char len2 );</pre> <p>Operands:</p> <ul style="list-style-type: none"> <li>• op1 represents the first operand in the hardware instruction. It points to the first operand location.</li> <li>• len1 specifies the length encoded in the machine instruction (that is, the number of additional bytes to the left of the first operand). The value is between 0 and 15.</li> <li>• op2 represents the second operand in the hardware instruction. It points to the second operand location.</li> <li>• len2 specifies the length encoded in the machine instruction (that is, the number of additional bytes to the left of the second operand). The value is between 0 and 15.</li> </ul> <p><b>Note:</b> When either len1 or len2 is not specified as a literal, an EX instruction is generated to execute a target CP instruction with length encoded in the register used by the EX instruction.</p> <p>The return value is the condition code set by the CP instruction.</p>	<pre>CP Op1D(len1, Op1B), Op2D(len2, Op2B)</pre>	ARCH(0)

Table 98. Decimal instruction prototypes (continued)

PROTOTYPE and Notes	Sample Pseudo Assembly	MIN ARCH
<p>void __dp (unsigned char *op1, unsigned char len1, unsigned char *op2, unsigned char len2 );</p> <p>Operands:</p> <ul style="list-style-type: none"> <li>• op1 represents the first operand (dividend) in the hardware instruction. It points to the first operand location. The result replaces the first operand. The quotient is placed leftmost in this location. The number of bytes in the quotient field is equal to the difference between the dividend and divisor lengths (len1 - len2). The remainder is placed rightmost in this location and has a length equal to the divisor length len2.</li> <li>• len1 specifies the length encoded in the machine instruction (that is, the number of additional bytes to the left of the first operand). The value must be greater than len2 and not greater than 15.</li> <li>• op2 represents the second operand (divisor) in the hardware instruction. It points to the second operand location.</li> <li>• len2 specifies the length encoded in the machine instruction (that is, the number of additional bytes to the left of the second operand). The value is between 0 and 7 and must be less than the value of len1.</li> </ul> <p><b>Note:</b> When either len1 or len2 is not specified as a literal, an EX instruction is generated to execute a target DP instruction with length encoded in the register used by the EX instruction.</p>	<p>DP Op1D(len1, Op1B), Op2D(len2, Op2B)</p>	<p>ARCH(0)</p>
<p>int __ed (unsigned char *OP1, unsigned char *OP2, unsigned char length);</p> <p>Operands:</p> <ul style="list-style-type: none"> <li>• op2 (the source), which normally contains one or more decimal numbers in the signed-packed-decimal or unsigned-packed-decimal format, is changed to the zoned format and modified under the control of op1 (the pattern). The edited result replaces op1.</li> <li>• len specifies the length encoded in the machine instruction (that is, the number of additional bytes to the right of the first operand).</li> <li>• The length of op2 is determined by the operation according to the contents of the pattern. The leftmost four bits of each source byte must specify a decimal-digit code (0000-1001); a sign code (1010-1111) is recognized as a data exception. The rightmost four bits may specify either a sign code or a decimal-digit code. Access and data exceptions are recognized only for those bytes in op2 which are actually required.</li> </ul> <p>The return value is the condition code.</p>	<p>ED Op1D(len,Op1B), Op2D(Op2B)</p>	<p>ARCH(0)</p>

Table 98. Decimal instruction prototypes (continued)

PROTOTYPE and Notes	Sample Pseudo Assembly	MIN ARCH
<p>int __edmk (unsigned char *OP1, unsigned char *OP2, unsigned char length, unsigned char **R1);</p> <p>Operands:</p> <ul style="list-style-type: none"> <li>• op2 (the source), which normally contains one or more decimal numbers in the signed-packed-decimal or unsigned-packed-decimal format, is changed to the zoned format and modified under the control of op1 (the pattern). The edited result replaces op1.</li> <li>• len specifies the length encoded in the machine instruction (that is, the number of additional bytes to the right of the first operand).</li> <li>• __edmk is identical to __ed except for the additional function of inserting the address of the result byte in general register 1 if the result byte is a zoned source digit and the significance indicator was off before the examination. If no result byte meets the criteria, general register 1 remains unchanged; if more than one result byte meets the criteria, the address of the rightmost such result byte is inserted.</li> <li>• In the 24-bit addressing mode, the address replaces bits 40-63 of general register 1, and bits 0-39 of the register are not changed. In the 31-bit addressing mode, the address replaces bits 33-63 of general register 1, bit 32 of the register is set to zero, and bits 0-31 of the register remain unchanged. In the 64-bit addressing mode, the address replaces bits 0-63 of general register 1.</li> </ul> <p>The return value is the condition code.</p>	<p>EDMK Op1D(len,Op1B), Op2D(Op2B)</p>	<p>ARCH(0)</p>
<p>void __mp (unsigned char *op1, unsigned char len1, unsigned char *op2, unsigned char len2 );</p> <p>Operands:</p> <ul style="list-style-type: none"> <li>• op1 represents the first operand (multiplicand) in the hardware instruction. It points to the first operand location. The result replaces the first operand. The multiplicand must have at least as many bytes of leftmost zeros as the number of bytes in the multiplier.</li> <li>• len1 specifies the length encoded in the machine instruction (that is, the number of additional bytes to the left of the first operand). The value must be greater than len2 and not greater than 15.</li> <li>• op2 represents the second operand (multiplier) in the hardware instruction. It points to the second operand location.</li> <li>• len2 specifies the length encoded in the machine instruction (that is, the number of additional bytes to the left of the second operand). The value is between 0 and 7 and must be less than the value of len1.</li> </ul> <p><b>Note:</b> When either len1 or len2 is not specified as a literal, an EX instruction is generated to execute a target MP instruction with length encoded in the register used by the EX instruction.</p>	<p>MP Op1D(len1, Op1B), Op2D(len2, Op2B)</p>	<p>ARCH(0)</p>

Table 98. Decimal instruction prototypes (continued)

PROTOTYPE and Notes	Sample Pseudo Assembly	MIN ARCH
<p>int __sp (unsigned char *op1, unsigned char len1, unsigned char *op2, unsigned char len2 );</p> <p>Operands:</p> <ul style="list-style-type: none"> <li>• op1 represents the first operand in the hardware instruction. It points to the first operand location. The result replaces the first operand.</li> <li>• len1 specifies the length encoded in the machine instruction (that is, the number of additional bytes to the left of the first operand). The value is between 0 and 15.</li> <li>• op2 represents the second operand in the hardware instruction. It points to the source location.</li> <li>• len2 specifies the length encoded in the machine instruction (that is, the number of additional bytes to the left of the second operand). The value is between 0 and 15.</li> </ul> <p><b>Note:</b> When either len1 or len2 is not specified as a literal, an EX instruction is generated to execute a target SP instruction with length encoded in the register used by the EX instruction.</p> <p>The return value is the condition code set by the SP instruction.</p>	<p>SP Op1D(len1, Op1B), Op2D(len2, Op2B)</p>	<p>ARCH(0)</p>
<p>int __srp (unsigned char *op1, unsigned char len1, signed char op2, unsigned char op3 );</p> <p>Operands:</p> <ul style="list-style-type: none"> <li>• op1 represents the first operand in the hardware instruction. It points to the source location. The result replaces the first operand.</li> <li>• len1 specifies the length encoded in the machine instruction (that is, the number of additional bytes to the left of the first operand). The value is between 0 and 15.</li> <li>• op2 represents the second operand in the hardware instruction. It is a shift value between -32 and 31. Positive shift values specify shifting to the left. Negative shift values specify shifting to the right.</li> <li>• op3 represents the third operand in the hardware instruction. It is used as a decimal rounding digit.</li> </ul> <p><b>Note:</b> When either len1 or op3 is not specified as a literal, an EX instruction is generated to execute a target SRP instruction with len1 or op3 encoded in the register used by the EX instruction.</p> <p>The return value is the condition code set by the SRP instruction.</p>	<p>SRP Op1D(len1, Op1B), Op2D(Op2B), Op3</p>	<p>ARCH(0)</p>

Table 98. Decimal instruction prototypes (continued)

PROTOTYPE and Notes	Sample Pseudo Assembly	MIN ARCH
<pre>int __tp(char *op1, unsigned char op1_len);</pre> <p>Operands:</p> <ul style="list-style-type: none"> <li>• op1 points to a byte string to be tested for a valid packed-decimal value.</li> <li>• op1_len specifies the length encoded in the machine instruction (that is, the number of additional bytes to the left of the first operand used in the machine instruction). The value is between 0 and 15.</li> </ul> <p><b>Note:</b> When op1_len is not specified as a literal, an EX instruction is generated to execute a target TP instruction with op1_len encoded in the register used by the EX instruction.</p> <p>The return value is the condition code set by the TP instruction.</p>	<pre>TP Op1D(Op1_len, Op1B)</pre>	ARCH(6)
<pre>int __zap(unsigned char *op1, unsigned char len1, unsigned char *op2, unsigned char len2 );</pre> <p>Operands:</p> <ul style="list-style-type: none"> <li>• op1 represents the first operand in the hardware instruction. It points to the location to receive the result.</li> <li>• len1 specifies the length encoded in the machine instruction (that is, the number of additional bytes to the left of the sign byte of the first operand). The value is between 0 and 15.</li> </ul> <p><b>Note:</b> When len1 is not specified as a literal, an EX instruction is generated to execute a target ZAP instruction with len1 encoded in the register used by the EX instruction.</p> <ul style="list-style-type: none"> <li>• op2 represents the second operand in the hardware instruction. It points to the start location.</li> <li>• len2 specifies the length encoded in the machine instruction (that is, the number of additional bytes to the left of the sign byte of the second operand). The value is between 0 and 15.</li> </ul> <p><b>Note:</b> When len2 is not specified as a literal, an EX instruction is generated to execute a target ZAP instruction with len2 encoded in the register used by the EX instruction.</p> <p>The return value is the condition code set by the ZAP instruction.</p>	<pre>ZAP Op1D(len1, Op1B), Op2D(len2, Op2B)</pre>	ARCH(0)

## Floating-point support instructions

These functions are intended to help convert between the two floating point formats. For more information on these instructions, see chapter 9 of *z/Architecture Principles of Operation*.

If you want to use any of the following instructions, your program must include the `builtins.h` header file and be compiled with `LANGLVL(EXTENDED)` or `LANGLVL(LIBEXT)`.

Table 99. Floating-point instruction prototypes

PROTOTYPE and Notes	Sample Pseudo Assembly	MIN ARCH
<pre>int __tldr(double *Op1, int M3, double Op2)</pre> <p>The return value is the condition code.</p>	<pre>TBDR F1,M3,Op2 LDR *Op1,F1</pre>	ARCH(3)



Table 99. Floating-point instruction prototypes (continued)

PROTOTYPE and Notes	Sample Pseudo Assembly	MIN ARCH
<pre>int __tbedr(double *Op1, int M3, float Op2)</pre> <p>The return value is the condition code.</p>	<pre>TBEDR F1,M3,Op2 LDR *Op1,F1</pre>	ARCH(3)
<pre>int __thder(double *Op1, float Op2)</pre> <p>The return value is the condition code.</p>	<pre>THDER F1,Op2 LDR *Op1,F1</pre>	ARCH(3)
<pre>int __thdr(double *Op1, double Op2)</pre> <p>The return value is the condition code.</p>	<pre>THDR F1,Op2 LDR *Op1,F1</pre>	ARCH(3)

## Decimal floating-point built-in functions

Decimal floating-point built-in functions are provided for each DFP hardware instruction. XL C/C++ developers can use the decimal floating-point built-in functions and macros, or named constants, by calling the functions with appropriate parameters. It is not necessary to include a header file before using decimal floating-point built-in functions. They will be automatically defined by the compiler when DFP is enabled.

All decimal floating-point built-in functions require a hardware level of at least ARCH(7).

Single precision support is limited, as noted in Table 100.

Table 100. Decimal floating-point instruction prototypes for IEEE operations

PROTOTYPE and Notes	Description
<pre>_Decimal32 __d32_abs (_Decimal32); _Decimal64 __d64_abs (_Decimal64); _Decimal128 __d128_abs (_Decimal128);</pre> <p><b>Note:</b> Also see functions that return the negative absolute value and functions that return the absolute value of the first parameter with the sign of the second parameter.</p>	These functions return the absolute value of the parameter.
<pre>_Decimal32 __d32_copysign (_Decimal32 exponent_and_fraction, _Decimal32 sign); _Decimal64 __d64_copysign (_Decimal64 exponent_and_fraction, _Decimal64 sign); _Decimal128 __d128_copysign (_Decimal128 exponent_and_fraction, _Decimal128 sign);</pre>	These functions return the absolute value of the first parameter, with the sign of the second parameter.
<pre>_Decimal32 __d32_sNaN (void); _Decimal64 __d64_sNaN (void); _Decimal128 __d128_sNaN (void); _Decimal32 __d32_qNaN (void); _Decimal64 __d64_qNaN (void); _Decimal128 __d128_qNaN (void);</pre>	These functions create quiet or signaling NaNs of the specified precision, with positive signs and zero payloads.

Table 100. Decimal floating-point instruction prototypes for IEEE operations (continued)

PROTOTYPE and Notes	Description
<pre> _Decimal64  __d64_integral (_Decimal64); _Decimal128 __d128_integral (_Decimal128); _Decimal64  __d64_integral_no_inexact (_Decimal64); _Decimal128 __d128_integral_no_inexact (_Decimal128); </pre> <p>The functions <code>__d64_integral</code> and <code>__d128_integral</code> allow an inexact exception. The instruction M4 bit 21 is set to 0.</p> <p>The functions <code>__d64_integral_no_inexact</code> and <code>__d128_integral_no_inexact</code> suppress any inexact exception. The instruction M4 bit 21 is set to 1.</p> <p>All these functions set the instruction M4 bit 20 to 0. If the input is a signaling NaN it is converted to a quiet NaN.</p>	<p>These functions round a decimal floating point value to an integer value in decimal floating point format; any digits after the decimal point are discarded. The current rounding mode is used.</p>
<pre> _Decimal64  __d64_quantize (_Decimal64, _Decimal64, long round_mode); _Decimal128 __d128_quantize (_Decimal128, _Decimal128, long round_mode); </pre> <p>The <code>round_mode</code> parameter must be a compile-time constant expression. Use either of the following:</p> <ul style="list-style-type: none"> <li>• <code>DFP_ROUND_USING_CURRENT_MODE</code> (8) to use the current rounding mode.</li> <li>• One of the values that can be set by <code>__dfp_set_round_mode</code> to temporarily override the current rounding mode. See “Definitions that support FPC register-rounding macros” on page 542.</li> </ul>	<p>These functions return the arithmetic value of the first parameter, with the exponent adjusted to match the second parameter. They can temporarily override the current rounding mode and use the specified rounding mode.</p>
<pre> bool  __d64_same_quantum (_Decimal64, _Decimal64); bool  __d128_same_quantum (_Decimal128, _Decimal128); </pre>	<p>These functions compare the exponents of two parameters. If the exponents are the same, the functions return "true".</p>
<pre> long  __d64_compare_signaling (_Decimal64, _Decimal64); long  __d128_compare_signaling (_Decimal128, _Decimal128); </pre> <p>These functions normally return <code>&lt;0</code>, <code>==0</code> or <code>&gt;0</code> to indicate the relation. If either value is a NaN, they return "-2" (unordered).</p>	<p>These functions compare two decimal floating-point values. Unlike a comparison using standard equality or relational operators, they also raise an Invalid Operation exception when either operand is either a quiet Nan or a signaling NaN.</p>

Table 100. Decimal floating-point instruction prototypes for IEEE operations (continued)

PROTOTYPE and Notes	Description
<pre>long long __d64_to_long_long (_Decimal64); long long __d128_to_long_long (_Decimal128);  long long __d64_to_long_long_rounding (_Decimal64, long round_mode); long long __d128_to_long_long_rounding (_Decimal128, long round_mode);</pre> <p>The functions <code>__d64_to_long_long ( )</code> and <code>__d128_to_long_long ( )</code> use the current decimal rounding mode, while a cast always rounds towards zero.</p> <p>The functions <code>__d64_to_long_long_rounding ( )</code> and <code>__d128_to_long_long_rounding ( )</code> can temporarily override the current rounding mode and use the specified rounding mode.</p> <p>The <code>round_mode</code> parameter must be a compile-time constant expression. Use either of the following:</p> <ul style="list-style-type: none"> <li>• <code>DFP_ROUND_USING_CURRENT_MODE</code> (8) to use the current rounding mode.</li> <li>• One of the values that can be set by <code>__dfp_set_round_mode</code> to temporarily override the current rounding mode. See “Definitions that support FPC register-rounding macros” on page 542.</li> </ul>	<p>These functions convert a decimal floating point value to a 64-bit signed binary integer with rounding mode options.</p>
<pre>unsigned long __dfp_get_round_mode (void);</pre> <p><b>Note:</b> See “Definitions that support FPC register-rounding macros” on page 542.</p>	<p>This function gets the current decimal rounding mode from the z/Architecture® FPC register.</p>
<pre>void __dfp_set_round_mode (unsigned long round_mode);</pre> <p>If the rounding mode is changed within a function, it must be restored before the function returns.</p> <p><b>Note:</b> See “Definitions that support FPC register-rounding macros” on page 542.</p>	<p>This function sets the specified decimal rounding mode in the z/Architecture FPC register, making it the current mode.</p>

Table 101. Decimal floating-point instruction prototypes for IEEE . . . is operations

PROTOTYPE and Notes	Description
<pre>bool __d32_isfinite (_Decimal32); bool __d64_isfinite (_Decimal64); bool __d128_isfinite (_Decimal128);</pre>	<p>These functions return "true" if the parameter is not positive or negative infinity, and is not a NaN.</p>
<pre>bool __d32_isinf (_Decimal32); bool __d64_isinf (_Decimal64); bool __d128_isinf (_Decimal128);</pre>	<p>These functions return "true" if the parameter is positive or negative infinity.</p>
<pre>bool __d32_isnormal (_Decimal32); bool __d64_isnormal (_Decimal64); bool __d128_isnormal (_Decimal128);</pre>	<p>These functions return "true" if the parameter is in the normal range, not a subnormal, infinity or NaN.</p>
<pre>bool __d32_issignaling (_Decimal32); bool __d64_issignaling (_Decimal64); bool __d128_issignaling (_Decimal128);</pre>	<p>These functions return "true" if the parameter is positive or negative signaling NaN.</p>
<pre>bool __d32_issigned (_Decimal32); bool __d64_issigned (_Decimal64); bool __d128_issigned (_Decimal128);</pre>	<p>These instructions return "true" if the parameter is negative, including negative zero, negative infinity and negative NaN.</p>
<pre>bool __d32_issubnormal (_Decimal32); bool __d64_issubnormal (_Decimal64); bool __d128_issubnormal (_Decimal128);</pre>	<p>These functions return "true" if the parameter is a subnormal.</p>

Table 101. Decimal floating-point instruction prototypes for IEEE . . . is operations (continued)

PROTOTYPE and Notes	Description
<pre>bool __d32_iszero (_Decimal32); bool __d64_iszero (_Decimal64); bool __d128_iszero (_Decimal128);</pre>	These functions return "true" if the parameter is positive or negative zero.

Table 102. Decimal floating-point instruction prototypes for IBM Instructions

PROTOTYPE and Notes	Description
<pre>_Decimal32 __d32_nabs (_Decimal32); _Decimal64 __d64_nabs (_Decimal64); _Decimal128 __d128_nabs (_Decimal128);</pre> <p><b>Note:</b> Also see functions that return the absolute value and functions that return the absolute value of the first parameter with the sign of the second parameter.</p>	These functions return the negative of the absolute value of the parameter.
<pre>long long __d32_to_gpr (_Decimal32); long long __d64_to_gpr (_Decimal64); void __d128_to_gprs (_Decimal128, long long *upper, long long *lower);</pre> <p><b>Note:</b> Also see functions that transfer a value from GPRs.</p>	These functions transfer a value from an FPR or FPR pair to a GPR, GPR pair, or four GPRs.
<pre>_Decimal32 __gpr_to_d32 (long long); _Decimal64 __gpr_to_d64 (long long); _Decimal128 __gprs_to_d128 (long long upper, long long lower);</pre> <p><b>Note:</b> Also see functions that transfer a value to GPRs.</p>	These functions transfer a value from a GPR, GPR pair, or four GPRs to an FPR or FPR pair.
<pre>_Decimal32 __d64_round_to_d32 (_Decimal64, unsigned long round_mode, bool suppress_invalid);  _Decimal64 __d128_round_to_d64 (_Decimal128, unsigned long round_mode, bool suppress_invalid);</pre> <p>The round_mode parameter must be a compile-time constant expression. Use either of the following:</p> <ul style="list-style-type: none"> <li>• DFP_ROUND_USING_CURRENT_MODE (8) to use the current rounding mode.</li> <li>• One of the values that can be set by __dfp_set_round_mode to temporarily override the current rounding mode. See "Definitions that support FPC register-rounding macros" on page 542.</li> </ul> <p>If the input value is a signaling NaN, and:</p> <ul style="list-style-type: none"> <li>• If suppress_invalid is false, the result will be a quiet NaN and an invalid operation exception will be raised.</li> <li>• If suppress_invalid is true, the result will be a signaling NaN and no exception will be raised.</li> </ul>	These functions convert a value to a narrower format, with rounding control and invalid exception control that is unavailable when using a cast.

Table 102. Decimal floating-point instruction prototypes for IBM Instructions (continued)

PROTOTYPE and Notes	Description
<pre>long long __d64_to_signed_BCD (_Decimal64, bool CF);</pre> <pre>void __d128_to_signed_BCD (_Decimal128, bool CorF,                           unsigned long long *upper,                           unsigned long long *lower);</pre> <p><code>__d64_to_signed_BCD</code> produces 15 decimal digits followed by a decimal sign in a 64-bit result.</p> <p><code>__d128_to_signed_BCD</code> produces 31 decimal digits followed by a decimal sign in a 128-bit result.</p> <p>Negative values will be given the sign 0xD.</p> <p>If CorF is false, positive values will be given the sign 0xC.</p> <p>If CorF is true, positive values will be given the sign 0xF.</p>	<p>These functions convert the lower digits of the parameter to signed packed format.</p>
<pre>_Decimal64 __signed_BCD_to_d64 (signed long long);</pre> <pre>_Decimal128 __signed_BCD_to_d128 (signed long long upper,                                    signed long long lower);</pre> <p>The signs 0xA, 0xC, 0xE, and 0xF will be treated as positive, and 0xB and 0xD as negative.</p> <p><code>__signed_BCD_to_d64</code> converts 15 decimal digits followed by a decimal sign in a 64-bit input.</p> <p><code>__signed_BCD_to_d128</code> converts 31 decimal digits followed by a decimal sign in a 128-bit input.</p>	<p>These functions convert signed packed decimal to decimal floating point.</p>
<pre>_Decimal64 __unsigned_BCD_to_d64 (unsigned long long);</pre> <pre>_Decimal128 __unsigned_BCD_to_d128 (unsigned long long upper,                                      unsigned long long lower);</pre> <p><code>__unsigned_BCD_to_d64</code> converts 16 decimal digits with no sign in a 64-bit input.</p> <p><code>__unsigned_BCD_to_d128</code> converts 32 decimal digits with no sign in a 128-bit input.</p>	<p>These functions convert the lower digits of the parameter to unsigned packed format.</p>
<pre>_Decimal64 __d64_reround (_Decimal64, unsigned long number_of_digits, unsigned long round_mode);</pre> <pre>_Decimal128 __d128_reround (_Decimal128, unsigned long number_of_digits, unsigned long round_mode);</pre> <p>The <code>round_mode</code> parameter must be a compile-time constant expression. Use either of the following:</p> <ul style="list-style-type: none"> <li>• <code>DFP_ROUND_USING_CURRENT_MODE</code> (8) to use the current rounding mode.</li> <li>• One of the values that can be set by <code>__dfp_set_round_mode</code> to temporarily override the current rounding mode. See “Definitions that support FPC register-rounding macros” on page 542.</li> </ul>	<p>These functions round a value to fewer digits. They can temporarily override the current rounding mode. For correct rounding, the input value must have been calculated using</p> <p><code>ROUND_TO_PREPARE_FOR_SHORTER_PRECISION</code></p> <p>For details, see “Definitions that support FPC register-rounding macros” on page 542.</p>

Table 102. Decimal floating-point instruction prototypes for IBM Instructions (continued)

PROTOTYPE and Notes	Description
<pre> _Decimal64 __d64_insert_biased_exponent (_Decimal64, long biased_exponent);  _Decimal128 __d128_insert_biased_exponent (_Decimal128, long biased_exponent); </pre> <p><b>Notes:</b></p> <ol style="list-style-type: none"> <li>1. Also see the functions that return the exponent of a specified parameter.</li> <li>2. For the type definitions of infinity, quiet NaN, or signaling NaN, see “Biased exponent definitions” on page 542.</li> </ol>	<p>These functions return the digits and sign of the first parameter with the biased exponent of the second parameter, with special values for infinity, quiet NaN, or signaling NaN.</p>
<pre> _Decimal64 __d64_shift_left (_Decimal64, unsigned long number_of_digits);  _Decimal128 __d128_shift_left (_Decimal128, unsigned long number_of_digits); </pre> <p><b>Note:</b> Also see functions that return the parameter with the coefficient shifted to the right.</p>	<p>These functions return the parameter with the coefficient shifted to the left. The sign and exponent are unchanged. The shift count must be in the 0-to-63 range; otherwise the result is undefined.</p>
<pre> _Decimal64 __d64_shift_right (_Decimal64, unsigned long number_of_digits);  _Decimal128 __d128_shift_right (_Decimal128, unsigned long number_of_digits); </pre> <p><b>Note:</b> Also see functions that return the parameter with the coefficient shifted to the left.</p>	<p>These functions return the parameter with the coefficient shifted to the right. The sign and exponent are unchanged. The shift count must be in the 0-to-63 range; otherwise the result is undefined.</p>
<pre> long __d32_test_data_class (_Decimal32, unsigned long data_class_mask);  long __d64_test_data_class (_Decimal64, unsigned long data_class_mask);  long __d128_test_data_class (_Decimal128, unsigned long data_class_mask); </pre> <p>These functions:</p> <ul style="list-style-type: none"> <li>• Determine the exponent type (zero, subnormal, normal, infinity, quiet NaN or signaling NaN) and sign of the value.</li> <li>• Return a long integer that indicates whether the exponent matches the mask specifications. If there is a match, the function returns "1"; if there is no match, the function returns "0".</li> </ul> <p><b>Note:</b> The mask must be a constant expression at compile time. See “Test Data Class masks” on page 543.</p> <p>Also see test data group functions.</p>	<p>These functions determine whether a parameter is in a defined data class or a set of data classes, by testing its exponent and sign.</p>

Table 102. Decimal floating-point instruction prototypes for IBM Instructions (continued)

PROTOTYPE and Notes	Description
<pre>long __d32_test_data_group (_Decimal32, unsigned long data_group_mask);  long __d64_test_data_group (_Decimal64, unsigned long data_group_mask);  long __d128_test_data_group (_Decimal128, unsigned long data_group_mask);</pre> <p>These functions:</p> <ul style="list-style-type: none"> <li>Determine the exponent type (safe zero, subnormal, normal with no leading zero, or an infinity or NaN), as well as the sign and first digit of the parameter. <b>Notes:</b> <ol style="list-style-type: none"> <li>A "safe zero" has leading zero digits and a non-extreme exponent.</li> <li>A "subnormal" can appear as either an extreme non-zero or a safe non-zero.</li> </ol> </li> <li>Return a long integer that indicates whether the exponent matches the mask specifications. If there is a match, the function returns "1"; if there is no match, the function returns "0". <b>Note:</b> The mask must be a constant expression at compile time. For the statements that define these masks, see "Test Data Group masks" on page 543.</li> </ul> <p>Also see the test data class functions.</p>	<p>These functions determine whether a parameter is in a defined data group or set of data groups, by testing its exponent, sign and first digit.</p>
<pre>long __d64_biased_exponent (_Decimal64); long __d128_biased_exponent (_Decimal128);</pre> <p><b>Notes:</b></p> <ol style="list-style-type: none"> <li>Also see functions that return the digits and sign of the first parameter with the biased exponent of the second parameter.</li> <li>See "Biased exponent definitions" on page 542.</li> </ol>	<p>These functions return the exponent of the parameter as an integer.</p>
<pre>unsigned long long __d64_to_unsigned_BCD (_Decimal64);  void __d128_to_unsigned_BCD (_Decimal128,                              bool CorF,                              unsigned long long *upper,                              unsigned long long *lower);</pre> <p>Positive values will be given the sign 0xC if CorF is false or 0xF if it is true. Negative values will be given the sign 0xD.</p> <p><code>__d64_to_unsigned_BCD</code> produces 16 decimal digits with no sign in a 64-bit result.</p> <p><code>__d128_to_unsigned_BCD</code> produces 32 decimal digits with no sign in a 128-bit result.</p> <p><b>Note:</b> Any digits to the left of those are ignored. To access the ignored digits, use the appropriate <code>__d#_shift_right</code> function.</p>	<p>These functions convert the lower digits of the parameter to unsigned packed format.</p>
<pre>long __d64_compare_exponents (_Decimal64, _Decimal64); long __d128_compare_exponents (_Decimal128, _Decimal128);</pre> <p>If both exponents are finite, these return "&lt;0", "==0" or "&gt;0" to indicate the relation between the exponents.</p> <p>If both exponents are infinite, they return "0".</p> <p>If one exponent is infinite and the other is finite, they return "-2" (unordered).</p>	<p>These functions compare exponents to one another.</p>

Table 102. Decimal floating-point instruction prototypes for IBM Instructions (continued)

PROTOTYPE and Notes	Description
<pre>long  __d64_extract_significance (_Decimal64); long  __d128_extract_significance (_Decimal128);</pre>	<p>These functions normally return the number of significant digits in the input value.</p> <p>Exceptions:</p> <ul style="list-style-type: none"> <li>• When the input is a zero, the return value is "0".</li> <li>• When the input is an infinity, the return value is "-1".</li> <li>• When the input is a quiet NaN, the return value is "-2".</li> <li>• When the input is a signaling NaN, the return value is "-3".</li> </ul>
<pre>void  __SFASR (unsigned long);</pre> <p><b>Note:</b> See "Definitions that support FPC register-rounding macros" on page 542.</p>	<p>This function modifies the Floating Point Control (FCP) register, and could raise an exception.</p>

IBM zEnterprise® EC12 provides hardware instructions for conversions between decimal floating-point and zoned types. When both the DFP and ARCH(10) compiler options are in effect, the following hardware built-in functions are available:

Table 103. Instruction prototypes for conversions between decimal floating-point and zoned types

PROTOTYPE and Notes	Description
<pre>_Decimal64 __cdzt(void* source,                  unsigned char length,                  const unsigned char mask);  _Decimal128 __cxzt(void* source,                   unsigned char length,                   const unsigned char mask);</pre> <p>The source points to the memory location that contains data in valid zoned format.</p> <p>The length specifies the length of the source field encoded in the machine instruction. The range of the length value can be "0-15" for __cdzt and "0-33" for __cxzt. When the length value is not a literal, an EX instruction is generated to execute a target CDZT or CXZT instruction.</p> <p>The mask value provides the M3 value encoded in the machine instruction. The mask value must be provided as a literal.</p> <p>The return value is the converted decimal floating-point value.</p>	<p>These functions convert zoned type to decimal floating-point type.</p>



Table 103. Instruction prototypes for conversions between decimal floating-point and zoned types (continued)

PROTOTYPE and Notes	Description
<pre>int __czdt(_Decimal64 source,            void* result,            unsigned char length,            const unsigned char mask);  int __czxt(_Decimal128 source,            void* result,            unsigned char length,            const unsigned char mask);</pre> <p>The source contains the decimal floating-point value to be converted.</p> <p>The result points to the memory location that receives the converted data in zoned format.</p> <p>The length specifies the number of rightmost digits of the decimal floating-point value to be converted. The length value specifies the length of the result field encoded in the machine instruction in bytes. The range of the length value can be "0-15" for __czdt and "0-33" for __czxt. When the length value is not a literal, an EX instruction is generated to execute a target CZDT or CZXT instruction.</p> <p>The mask value provides the M3 value encoded in the machine instruction. The mask value must be provided as a literal.</p> <p>The return value is the condition code set by the instruction.</p>	<p>These functions convert decimal floating-point type to zoned type.</p>

## Macros for use with decimal floating-point built-in functions

You do not need to include a header file before you can use these macros.

### Definitions that support FPC register-rounding macros

Hardware built-in functions described in Table 100 on page 534 use the specified decimal rounding mode in the z/Architecture FPC register, making it the current mode. Figure 151 lists the statements that define those decimal rounding modes.

```
#define DFP_ROUND_TO_NEAREST_WITH_TIES_TO_EVEN      0
#define DFP_ROUND_TOWARD_ZERO                      1
#define DFP_ROUND_TOWARD_POSITIVE_INFINITY         2
#define DFP_ROUND_TOWARD_NEGATIVE_INFINITY         3
#define DFP_ROUND_TO_NEAREST_WITH_TIES_AWAY_FROM_ZERO 4
#define DFP_ROUND_TO_NEAREST_WITH_TIES_TOWARD_ZERO 5
#define DFP_ROUND_AWAY_FROM_ZERO                   6
#define DFP_ROUND_TO_PREPARE_FOR_SHORTER_PRECISION 7
#define DFP_ROUND_USING_CURRENT_MODE                8
```

Figure 151. z/Architecture FPC register-rounding mode definitions

**Note:** DFP\_ROUND\_USING\_CURRENT\_MODE applies the rounding mode currently set in the z/Architecture FPC register. It is for use in functions that can temporarily override the specified rounding mode.

### Biased exponent definitions

Hardware built-in functions that return biased exponents use special values to identify or specify the exponent type. An exponent type could be integer, infinity, quiet NaN, or signaling NaN. These functions are described in Table 102 on page 537.

Figure 152 lists the statements that define those special values.

```
#define DFP_BIASED_EXPONENT_FINITE      0      /* integer type exponent plus bias */
#define DFP_BIASED_EXPONENT_INFINITY  -1
#define DFP_BIASED_EXPONENT_QNAN      -2
#define DFP_BIASED_EXPONENT_SNaN      -3
```

Figure 152. Biased exponent type definitions

### Test Data Class masks

Test Data Class functions, which test the exponent of a parameter, must be used with at least one Test Data Class mask. Test Data Class functions are described in Table 102 on page 537.

The following supplied masks look for an exponent with a specific type and sign:

```
DFP_Z_DATA_CLASS_POSITIVE_ZERO
DFP_Z_DATA_CLASS_NEGATIVE_ZERO
DFP_Z_DATA_CLASS_POSITIVE_SUBNORMAL
DFP_Z_DATA_CLASS_NEGATIVE_SUBNORMAL
DFP_Z_DATA_CLASS_POSITIVE_NORMAL
DFP_Z_DATA_CLASS_NEGATIVE_NORMAL
DFP_Z_DATA_CLASS_POSITIVE_INFINITY
DFP_Z_DATA_CLASS_NEGATIVE_INFINITY
DFP_Z_DATA_CLASS_POSITIVE_QUIET_NAN
DFP_Z_DATA_CLASS_NEGATIVE_QUIET_NAN
DFP_Z_DATA_CLASS_POSITIVE_SIGNALING_NAN
DFP_Z_DATA_CLASS_NEGATIVE_SIGNALING_NAN
```

Figure 153. Test Data Class masks

**Note:** A subnormal is also known as *denorm*.

To get a Test Data Class function to perform a desired test more efficiently, OR several of supplied masks together. For example, to determine whether the exponent of a parameter is any positive value, OR the following masks together:

- DFP\_Z\_DATA\_CLASS\_POSITIVE\_ZERO
- DFP\_Z\_DATA\_CLASS\_POSITIVE\_SUBNORMAL
- DFP\_Z\_DATA\_CLASS\_POSITIVE\_NORMAL
- DFP\_Z\_DATA\_CLASS\_POSITIVE\_INFINITY
- DFP\_Z\_DATA\_CLASS\_POSITIVE\_QUIET\_NAN
- DFP\_Z\_DATA\_CLASS\_POSITIVE\_SIGNALING\_NAN

### Test Data Group masks

Test Data Group functions, which test the exponent of a parameter, must be used with at least one Test Data Group mask. Test Data Group functions are described in Table 102 on page 537.

The following supplied Test Data Group masks look for an exponent that matches a specific type, sign, and first digit:

```

DFP_Z_DATA_GROUP_POSITIVE_ZERO_WITH_NONEXTREME_EXPONENT
DFP_Z_DATA_GROUP_NEGATIVE_ZERO_WITH_NONEXTREME_EXPONENT
DFP_Z_DATA_GROUP_POSITIVE_ZERO_WITH_EXTREME_EXPONENT
DFP_Z_DATA_GROUP_NEGATIVE_ZERO_WITH_EXTREME_EXPONENT
DFP_Z_DATA_GROUP_POSITIVE_SUBNORMAL_OR_EXTREME_EXPONENT
DFP_Z_DATA_GROUP_NEGATIVE_SUBNORMAL_OR_EXTREME_EXPONENT
DFP_Z_DATA_GROUP_POSITIVE_NONEXTREME_EXP_LEFTMOST_ZERO
DFP_Z_DATA_GROUP_NEGATIVE_NONEXTREME_EXP_LEFTMOST_ZERO
DFP_Z_DATA_GROUP_POSITIVE_NONEXTREME_EXP_LEFTMOST_NONZERO
DFP_Z_DATA_GROUP_NEGATIVE_NONEXTREME_EXP_LEFTMOST_NONZERO
DFP_Z_DATA_GROUP_POSITIVE_INFINITY_OR_NAN
DFP_Z_DATA_GROUP_NEGATIVE_INFINITY_OR_NAN

```

Figure 154. Test Data Group masks

To get a Test Group Class function to perform a desired test more efficiently, OR several of supplied masks together. For example, to determine whether a parameter is an extreme exponent, OR the following masks together:

- DFP\_Z\_DATA\_GROUP\_POSITIVE\_ZERO\_WITH\_EXTREME\_EXPONENT
- DFP\_Z\_DATA\_GROUP\_NEGATIVE\_ZERO\_WITH\_EXTREME\_EXPONENT

## Hexadecimal floating-point instructions

If the FLOAT(HEX) option is in effect, these functions are intended to generate hexadecimal floating-point instructions. For more information about the instructions themselves, see chapter 18 of *z/Architecture Principles of Operation*.

If you want to use any of the following functions, your program must include `builtins.h` and be compiled with either the `LANGLVL(EXTENDED)` option or the `LANGLVL(LIBEXT)` and `FLOAT(HEX)` options.

**Note:** Some of these instructions also require that the `ARCH` option is set to a minimum level.

Table 104. Hexadecimal floating-point instruction prototypes

PROTOTYPE and Notes	Sample Pseudo Assembly	MIN ARCH
<pre>int __cfer(int *Op1, int M3, float Op2)</pre> <p>The return value is the condition code.</p>	<pre>CFER R2,M3,Op2 LR *Op3,R2</pre>	ARCH(3)
<pre>int __cfdr(int *Op1, int M3, double Op2)</pre> <p>The return value is the condition code.</p>	<pre>CFDR R2,M3,Op2 LR *Op3,R2</pre>	ARCH(3)
<pre>int __cfxr(int *Op1, int M3, long double Op2)</pre> <p>The return value is the condition code.</p>	<pre>CFXR R2,M3,Op2 LR *Op3,R2</pre>	ARCH(3)
<pre>float __fier(float Op2)</pre> <p>The return value is the result.</p>	<pre>FIER F1,Op2</pre>	ARCH(3)
<pre>double __fidr(double Op2)</pre> <p>The return value is the result.</p>	<pre>FIDR F1,Op2</pre>	ARCH(3)
<pre>long double __fixr(long double Op2)</pre> <p>The return value is the result.</p>	<pre>FIXR F1,Op2</pre>	ARCH(3)
<pre>int __lnxr(long double *Op1, long double Op2)</pre> <p>The return value is the condition code.</p>	<pre>LDR F1,*Op1 LNXR F1,Op2 LDR *Op1,F1</pre>	ARCH(3)

Table 104. Hexadecimal floating-point instruction prototypes (continued)

PROTOTYPE and Notes	Sample Pseudo Assembly	MIN ARCH
int __lndr(double *Op1, double Op2) The return value is the condition code.	LDR F1,*Op1 LNDR F1,Op2 LDR *Op1,F1	ARCH(0)
int __lpdr(double *Op1, double Op2) The return value is the condition code.	LDR F1,*Op1 LPDR F1,Op2 LDR *Op1,F1	ARCH(0)
int __lpxr(long double *Op1, long double Op2) The return value is the condition code.	LDR F1,*Op1 LPXR F1,Op2 LDR *Op1,F1	ARCH(3)
int __lner(float *Op1, float Op2) The return value is the condition code.	LER F1,*Op1 LNER F1,Op2 LER *Op1,F1	ARCH(0)
int __lper(float *Op1, float Op2) The return value is the condition code.	LER F1,*Op1 LPER F1,Op2 LER *Op1,F1	ARCH(0)
float __sqer(float Op2) The return value is the square root.	SQER F1,Op2	ARCH(0) or above
double __sqdr(double Op2) The return value is the square root.	SQDR F1,Op2	ARCH(0) or above
long double __sqxr(long double Op2) The return value is the square root.	SQXR F1,Op2	ARCH(3)

## Binary floating-Point instructions

These functions are intended to generate binary floating-point instructions. These instructions will only be generated if the `FLOAT(IEEE)` option is in effect. For more information about the instructions themselves, see chapter 19 of *z/Architecture Principles of Operation*.

If you want to use any of the following functions, your program must include `builtins.h` and be compiled with either the `LANGLVL(EXTENDED)` option or the `LANGLVL(LIBEXT)` and `FLOAT(IEEE)` options.

Table 105. Binary floating-point instruction prototypes

PROTOTYPE and Notes	Sample Pseudo Assembly	MIN ARCH
int __cfdbf(int *Op1, int M3, double Op2) The return value is the condition code.	CFDBR R2,M3,Op2 LR *Op3,R2	ARCH(3)
int __cfefbr(int *Op1, int M3, float Op2) The return value is the condition code.	CFEBR R2,M3,Op2 LR *Op3,R2	ARCH(3)
int __cfxbr(int *Op1, int M3, long double Op2) The return value is the condition code.	CFXBR R2,M3,Op2 LR *Op3,R2	ARCH(3)
int __efpc(void) The return value is the z/Architecture FPC. <b>Note:</b> Also see functions that get and set FPC rounding modes and “Definitions that support FPC register-rounding macros” on page 542.	EFPC R1	ARCH(3)

Table 105. Binary floating-point instruction prototypes (continued)

PROTOTYPE and Notes	Sample Pseudo Assembly	MIN ARCH
float __fiebr(int M3, float Op2) The return value is the result.	FIEBR F1,M3,Op2	ARCH(3)
float __fmadds(float Op1, float Op2, float Op3) The return value is the result.	FMADDS Op1,Op3,Op2	ARCH(3)
double __fidbr(int M3, double Op2) The return value is the result.	FIDBR F1,M3,Op2	ARCH(3)
long double __fixbr(int M3, long double Op2) The return value is the result.	FIXBR F1,M3,Op2	ARCH(3)
int __didbr(double *rem, double *quotient, double Op3, double Op4 int M4) The return value is the condition code.	LDR F1,Op3 DIDBR F1,F3,Op4,M4 LDR *rem,F1 LDR *quotient,F3	ARCH(3)
int __lndbr(double *Op1, double Op2) The return value is the condition code.	LDR F1,*Op1 LNDBR F1,Op2 LDR *Op1,F1	ARCH(3)
int __lnxbr(long double *Op1, long double Op2) The return value is the condition code.	LDR F1,*Op1 LNDBR F1,Op2 LDR *Op1,F1	ARCH(3)
int __lpdbr(double *Op1, double Op2) The return value is the condition code.	LDR F1,*Op1 LPDBR F1,Op2 LDR *Op1,F1	ARCH(3)
int __lpxbr(long double *Op1, long double Op2) The return value is the condition code.	LDR F1,*Op1 LPDBR F1,Op2 LDR *Op1,F1	ARCH(3)
int __diebr(float *rem, float *quotient, float Op3, float Op4, int M4) The return value is the condition code.	LER F1,Op3 DIEBR F1,F3,Op4,M4 LER *rem,F1 LER *quotient,F3	ARCH(3)
int __lnebr(float *Op1, float Op2) The return value is the condition code.	LER F1,*Op1 LNEBR F1,Op2 LER *Op1,F1	ARCH(3)
int __lpebr(float *Op1, float Op2) The return value is the condition code.	LER F1,*Op1 LPEBR F1,Op2 LER *Op1,F1	ARCH(3)
double __madbr(double Op1, double Op2, double Op3) The return value is the result.	MADBR Op1,Op3,Op2	ARCH(3)
float __maebr(float Op1, float Op2, float Op3) The return value is the result.	MAEBR Op1,Op3,Op2	ARCH(3)
double __msdbr(double Op1, double Op2, double Op3) The return value is the condition code.	MSDBR Op1,Op3,Op2	ARCH(3)
float __msebr(float Op1, float Op2, float Op3) The return value is the result.	MSEBR Op1,Op3,Op2	ARCH(3)

Table 105. Binary floating-point instruction prototypes (continued)

PROTOTYPE and Notes	Sample Pseudo Assembly	MIN ARCH
void __sfpc(int Op1)  Only a constant literal can be passed to this built-in function. <b>Note:</b> See “Definitions that support FPC register-rounding macros” on page 542.	SFPC Op1	ARCH(3)
float __sqebr(float Op2)  The return value is the square root.	SQEBR F1,Op2	ARCH(3)
double __sqdbr(double Op2)  The return value is the square root.	SQDBR F1,Op2	ARCH(3)
long double __sqxbr(long double Op2)  The return value is the square root.	SQXBR F1,Op2	ARCH(3)
void __srnm(int Op1)	SRNM Op1	ARCH(3)
int __tceb(float Op1, int Op2)  The return value is the condition code.	TCEB Op1,Op2(0,0)	ARCH(3)
int __tcdb(double Op1, int Op2)  The return value is the condition code.	TCDB Op1,Op2(0,0)	ARCH(3)
int __tcxb(long double Op1, int Op2)  The return value is the condition code.	TCXB Op1,Op2(0,0)	ARCH(3)

## Built-in functions for transaction execution

Transactional memory is a model for controlling concurrent memory accesses in the scope of parallel programming. In this model, you can designate a block of instructions or statements to be treated atomically. Such a block is called a transaction.

When a thread of execution executes a transaction, it is seen by other threads as an atomic block. That is, all of the memory operations within the transaction are seen to occur simultaneously. At the end of the transaction, a decision is made to commit or abort the transaction. If the transaction is committed, results are written and the execution moves on. If it is aborted, the execution branches back to the beginning of the transaction and the original register state is restored, except for a single bit to indicate that a failure has occurred. The program can decide to retry or skip the transaction.

For parallel programming, a transaction implementation can be tremendously more efficient than other implementation methods. The following built-in functions provide the ability to mark the beginning and end of transactions, and to diagnose the reasons for failure. All the functions and types here will be defined in `builtins.h`.

Table 106. Built-in functions for transactional memory

PROTOTYPE and Notes	Description
<pre>long __TM_simple_begin(); long __TM_begin(void* const TM_buff);</pre> <p>The <code>__TM_simple_begin()</code> function leads to the cheap kind of transaction. Cheap transactions have higher performance, but if the transaction fails, the failure information available is only the two-bit cc returned by the <code>tbegin</code> hardware instruction.</p> <p>The <code>__TM_begin(const void* TM_buff)</code> function leads to the expensive kind of transaction. The address provided (<code>TM_buff</code>) must be valid. It points to a 256-byte transaction diagnostic block (TDB) containing various debug information. If the transaction fails, the TDB is populated with lots of information.</p> <p><b>Note:</b> Extensive control is provided over what state is saved and restored. These built-ins save all gpr's, and no fpr's or ar's. Using float values or ar-mode is not supported, and the facility of filtering some interrupts is not provided.</p>	<p>These functions start a transaction, a cheap transaction or an expensive one, corresponding to only some debugging capability or full debugging capability.</p> <p>The return value is "0" or non-zero indicating success or failure of the transaction.</p>
<pre>long __TM_end();</pre>	<p>This function marks the end of a transaction.</p> <p>The return value is non-zero if the thread was not in transactional state before the instruction started, and "0" otherwise.</p>
<pre>void __TM_abort(); void __TM_named_abort(unsigned char const code);</pre>	<p>These functions abort a transaction with a failure code, or "0" if none is provided.</p> <p>Providing a code enables the named abort functionality. The parameter code is constrained to be <math>0 \leq \text{code} \leq 255</math>.</p>
<pre>void __TM_abort_assist(unsigned int opl);</pre>	<p>This function requests assistance from the processor in performing a transaction-abort assist function.</p> <p>"opl" specifies the number of times the transaction has aborted.</p>
<pre>long __TM_is_user_abort(void* const TM_buff); long __TM_is_named_user_abort(void* const TM_buff, unsigned char* code);</pre>	<p>These functions return "1" if the transaction failed due to a user abort instruction, otherwise "0". The value returned in the parameter code is the code that was passed to the <code>tabort</code> instruction, or "0" if none was passed.</p> <p>If the TDB specified by <code>TM_buff</code> is valid and the transaction abort code is <math>\geq 256</math>, return "true" and set code to the transaction abort code minus 256, otherwise return "0".</p>
<pre>long __TM_is_illegal(void* const TM_buff);</pre>	<p>Returns "1" if the TDB specified by <code>TM_buff</code> is valid and the transaction aborted due to trying to do something illegal (an instruction not permitted in transactional mode or some other kind of illegal access.)</p> <p>Returns "1" if the TDB specified by <code>TM_buff</code> is valid and the transaction abort code is "11" or "4".</p>

Table 106. Built-in functions for transactional memory (continued)

PROTOTYPE and Notes	Description
long __TM_is_footprint_exceeded(void* const TM_buff);	<p>Returns "1" if the TDB specified by TM_buff is valid and the transaction aborted due to reaching the maximum number of cache lines, otherwise "0".</p> <p>Returns "1" if the TDB pointed at by TM_buff is valid and the transaction abort code is "7" or "8", otherwise returns "0".</p>
long __TM_nesting_depth(void* const TM_buff);	Returns the current nesting depth. If the thread is not in transactional mode, returns the depth at which the most recent transaction aborted, or "0" if it is completed successfully.
long __TM_is_nested_too_deep(void* const TM_buff);	<p>Returns "1" if the transaction aborted due to reaching the maximum nesting depth.</p> <p>Returns "1" if the TDB pointed at by TM_buff is valid and the transaction abort code is "13".</p>
long __TM_is_conflict(void* const TM_buff);	<p>Returns "1" if the transaction aborted due to a conflict.</p> <p>Returns "1" if the TDB pointed at by TM_buff is valid and the transaction abort code is "9" or "10", otherwise returns "0".</p>
long __TM_is_failure_persistent(long const result);	<p>Returns "1" if the transaction aborted due to a reason that is persistent.</p> <p>Returns "1" if result==3 (result should be the CC value returned by tbegin, which is stored in the int return value of tbegin), otherwise returns "0".</p>
long __TM_failure_address(void* const TM_buff);	<p>Returns the code address at which the most recent transaction aborted.</p> <p>For 64 bit: returns the fourth doubleword of the TDB.</p> <p>For 31 bit or 24 bit: returns the rightmost word of the TDB.</p>
long long __TM_failure_code(void* const TM_buff);	<p>Returns the raw failure code.</p> <p>Returns bytes 8-15 of the TDB.</p>
void __TM_non_transactional_store(void* const addr, long long const value);	This function indicates that 8 bytes provided by value are stored at the address pointed at by addr. The store is non-transactional.





---

## Chapter 34. Using runtime check library

The runtime check library provides a library routine that identifies the target hardware model to the application during its execution. This runtime check library also provides built-in functions that are associated with individual architectures to check for safety of the **arch\_section** directive during application execution.

If you have code sections that are customized for specific hardware, you can use these built-in functions to perform a fast and efficient safety check before entering the customized sections. For more information about the **arch\_section** directive, see #pragma arch\_section in *z/OS XL C/C++ User's Guide*.

### Check the type of CPU

```
void __builtin_cpu_init (void);
```

This built-in function runs the CPU detection code to check the type of CPU. This function must be invoked along with the `__builtin_cpu_is` and `__builtin_cpu_supports` built-in functions to check CPU type and features. This function must be run first so that CPU type is available to `__builtin_cpu_is` and `__builtin_cpu_supports`.

### Check features the CPU supports

```
int __builtin_cpu_supports(const char* feature);
```

This built-in function returns a positive integer if the runtime CPU supports the specified feature; otherwise, it returns 0. The following features are supported:

- "1" through "11"
- "dfp"
- "dfpzoned"
- "etf3"
- "htm"
- "interlocked"
- "loadstoreoncond"
- "loadstoreoncond2"
- "longdisplacemnt"
- "popcount"
- "prefetch"
- "storeclockfast"
- "vector128"

### Check the CPU model

```
int __builtin_cpu_is(const char* cpumodel);
```

This built-in function returns a positive integer if the runtime CPU is of type `cpumodel`; otherwise, it returns 0. Supported CPU is one of the models associate with "1", "2", "3", "4", "5", "6", "7", "8", "9", "10", and "11".

## Example

The following example shows the usage of the runtime check routine and built-in functions:

```
int main() {
    __builtin_cpu_init();
    if (__builtin_cpu_supports("dfp"))
        #pragma arch_section(7)
        // ....
    return SUCCESS;
}
```

---

## Chapter 35. Using vector programming support

XL C/C++ V2R1M1 web deliverable for z/OS 2.1 includes vector programming support for programmers by making use of the Vector Facility for z/Architecture.

The compiler supports vector processing technologies through language extensions, based on the AltiVec Programming Interface specification with suitable changes and extensions.

This chapter describes IBM XL C/C++ language extensions for vector processing support, including compiler options, vector data types and operators, macro, and built-in functions.

---

### Options

The vector language extensions are enabled only when all of the following conditions are met:

- The ARCH(11) option is specified.
- The FLOAT(AFP(NOVOLATILE)) option is in effect.
- The VECTOR option is specified.
- The TARGET(zOSV2R1) option or higher level is specified.

#### Notes:

- The VECTOR option requires z/OS V2R1 (or newer versions) with IBM z Systems™ z13™ (or newer hardware) support.
- The VECTOR option implies LANGLVL(LONGLONG), which enables the vector bool long long, vector signed long long, vector unsigned long long, \_\_vector bool long long, \_\_vector signed long long, and \_\_vector unsigned long long data types.
- The vector double and \_\_vector double data types are only available with FLOAT(IEEE).
- The SIMD or Vector code must run in a runtime environment that supports vector instructions and vector context switching. SIMD or Vector code that is compiled by z/OS V2R2 XL C/C++ might run into a runtime abend in the following environment:
  - z/OS image running on z/VM®
  - z/OS version older than V2R1 with PTF PI12281
  - CICS

For more information about these compiler options, see *z/OS XL C/C++ User's Guide*.

---

### Macro

The `__VEC__` macro is introduced for the vector processing support, which indicates support for vector data types. The predefined value of `__VEC__` is 10205.

## Vector data types

XL C/C++ V2R1M1 web deliverable for z/OS V2R1 includes vector programming support, which provides an efficient and expressive mechanism for programmers to make use of the Vector Facility for z/Architecture from the C and C++ programming languages. This section describes the supported vector data types.

In this syntax, type qualifiers and storage class specifiers can precede the keyword `vector` (or its alternative spelling, `__vector`) in a declaration. Most of the legal forms of the syntax are captured in the following diagram. Some variations have been omitted from the diagram for the sake of clarity: type qualifiers such as `const` and storage class specifiers such as `static` can appear in any order within the declaration, as long as neither immediately follows the keyword `vector` (or `__vector`).

### Vector declaration syntax

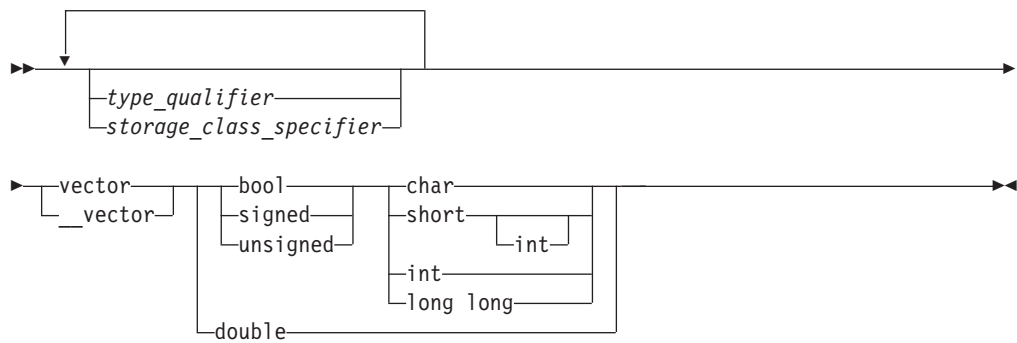

### Notes:

1. The keyword `__vector` is recognized with the option `VECTOR`, regardless of its suboptions.
2. The keyword `vector` is recognized with option `VECTOR(TYPE)`.
3. The keyword `bool` is recognized as a valid type specifier only when preceded by the keyword `vector` or `__vector`.
4. Duplicate type specifiers are ignored in a vector declaration context.
5. The vector `double` and `__vector double` data types are only available with `FLOAT(IEEE)`. The use of `vector double` or `__vector double` without `FLOAT(IEEE)` would result in a syntax error on the declaration.
6. The vector `bool long long`, `vector signed long long`, `vector unsigned long long`, `__vector bool long long`, `__vector signed long long`, and `__vector unsigned long long` data types are only available with `LANGLVL(LONGLONG)`, which is implied by the `VECTOR` option.

The following table lists the supported vector data types, the size and possible values for each type.

Table 107. Vector data types

Type	Interpretation of content	Range of values
vector unsigned char	16 unsigned char	0..255
vector signed char	16 signed char	-128..127

Table 107. Vector data types (continued)

Type	Interpretation of content	Range of values
vector bool char	16 unsigned char	0 (FALSE), 255 (TRUE)
vector unsigned short	8 unsigned short	0..65535
vector unsigned short int		
vector signed short	8 signed short	-32768..32767
vector signed short int		
vector bool short	8 unsigned short	0 (FALSE), 65535 (TRUE)
vector bool short int		
vector unsigned int	4 unsigned int	$0..2^{32}-1$
vector signed int	4 signed int	$-2^{31}..2^{31}-1$
vector bool int	4 unsigned int	0 (FALSE), $2^{32}-1$ (TRUE)
vector unsigned long long	2 unsigned long long	$0..2^{64}-1$
vector signed long long	2 signed long long	$-2^{63}..2^{63}-1$
vector bool long long	2 unsigned long long	0 (FALSE), $2^{64}-1$ (TRUE)
vector double	2 double	IEEE-754 double (64 bit) precision floating-point values

All vector types are aligned on an 8-byte boundary. An aggregate that contains one or more vector types is aligned on an 8-byte boundary, and padded, if necessary, so that each member of vector type is also 8-byte aligned.

## Language extensions

The C/C++ language is extended to support expressions and operations that are required to act on vector data types.

### Vector literals

A vector literal is a constant expression for which the value is interpreted as a vector type. The data type of a vector literal is represented by a parenthesized vector type, and its value is a set of constant expressions that represent the vector elements and are enclosed in parentheses or braces. When all vector elements have the same value, the value of the literal can be represented by a single constant expression. You can initialize vector types with vector literals.

#### Vector literal syntax

►► (—vector\_type—) { (—literal\_list—) }  
 { (—literal\_list—) }

#### literal\_list:

constant\_expression

The *vector\_type* is a supported vector type; see “Vector data types” on page 554 for a list of these.

The *literal\_list* can be either of the following expressions:

- A single expression.  
If the single expression is enclosed with parentheses, all elements of the vector are initialized to the specified value. If the single expression is enclosed with braces, the first element of the vector is initialized to the specified value, and the remaining elements of the vector are initialized to 0.
- A comma-separated list of expressions. Each element of the vector is initialized to the respectively specified value.

The number of constant expressions is determined by the type of the vector and whether it is enclosed with braces or parentheses.

If the comma-separated list of expressions is enclosed with braces, the number of constant expressions can be equal to or less than the number of elements in the vector. If the number of constant expressions is less than the number of elements in the vector, the values of the unspecified elements are 0.

If the comma-separated list of expressions is enclosed with parentheses, the number of constant expressions must match the number of elements in the vector as follows:

- 2 For vector unsigned long long, vector signed long long, vector bool long long, and vector double types.
- 4 For vector unsigned int, vector signed int, and vector bool int types.
- 8 For vector unsigned short, vector signed short, and vector bool short types.
- 16 For vector unsigned char, vector signed char, and vector bool char types.

The following table shows the supported vector literals and how the compiler interprets them to determine their values.

Table 108. Vector literals

Syntax	Interpreted by the compiler as
(vector unsigned char)( <i>unsigned int</i> )	A list of 16 unsigned 8-bit quantities that all have the value of the single integer.
(vector unsigned char)( <i>unsigned int</i> , ...) (vector unsigned char){ <i>unsigned int</i> , ...}	A list of 16 unsigned 8-bit quantities with the value specified by each of the 16 integers.
(vector signed char)( <i>int</i> )	A list of 16 signed 8-bit quantities that all have the value of the single integer.
(vector signed char)( <i>int</i> , ...) (vector signed char){ <i>int</i> , ...}	A list of 16 signed 8-bit quantities with the value specified by each of the 16 integers.
(vector bool char)( <i>unsigned int</i> )	A list of 16 unsigned 8-bit quantities that all have the value of the single integer.
(vector bool char)( <i>unsigned int</i> , ...) (vector bool char){ <i>unsigned int</i> , ...}	A list of 16 unsigned 8-bit quantities with a value specified by each of 16 integers.
(vector unsigned short)( <i>unsigned int</i> )	A list of 8 unsigned 16-bit quantities that all have the value of the single integer.
(vector unsigned short)( <i>unsigned int</i> , ...) (vector unsigned short){ <i>unsigned int</i> , ...}	A list of 8 unsigned 16-bit quantities with a value specified by each of the 8 integers.

Table 108. Vector literals (continued)

Syntax	Interpreted by the compiler as
(vector signed short)( <i>int</i> )	A list of 8 signed 16-bit quantities that all have the value of the single integer.
(vector signed short)( <i>int</i> , ...) (vector signed short){ <i>int</i> , ...}	A list of 8 signed 16-bit quantities with a value specified by each of the 8 integers.
(vector bool short)( <i>unsigned int</i> )	A list of 8 unsigned 16-bit quantities that all have the value of the single integer.
(vector bool short)( <i>unsigned int</i> , ...) (vector bool short){ <i>unsigned int</i> , ...}	A list of 8 unsigned 16-bit quantities with a value specified by each of the 8 integers.
(vector unsigned int)( <i>unsigned int</i> )	A list of 4 unsigned 32-bit quantities that all have the value of the single integer.
(vector unsigned int)( <i>unsigned int</i> , ...) (vector unsigned int){ <i>unsigned int</i> , ...}	A list of 4 unsigned 32-bit quantities with a value specified by each of the 4 integers.
(vector signed int)( <i>int</i> )	A list of 4 signed 32-bit quantities that all have the value of the single integer.
(vector signed int)( <i>int</i> , ...) (vector signed int){ <i>int</i> , ...}	A list of 4 signed 32-bit quantities with a value specified by each of the 4 integers.
(vector bool int)( <i>unsigned int</i> )	A list of 4 unsigned 32-bit quantities that all have the value of the single integer.
(vector bool int)( <i>unsigned int</i> , ...) (vector bool int){ <i>unsigned int</i> , ...}	A list of 4 unsigned 32-bit quantities with a value specified by each of the 4 integers.
(vector unsigned long long)( <i>unsigned long long</i> )	A list of 2 unsigned 64-bit quantities that both have the value of the single long long.
(vector unsigned long long)( <i>unsigned long long</i> , ...) (vector unsigned long long){ <i>unsigned long long</i> , ...}	A list of 2 unsigned 64-bit quantities specified with a value by each of the 2 unsigned long longs.
(vector signed long long)( <i>signed long long</i> )	A list of 2 signed 64-bit quantities that both have the value of the single long long.
(vector signed long long)( <i>signed long long</i> , ...) (vector signed long long){ <i>signed long long</i> , ...}	A list of 2 signed 64-bit quantities with a value specified by each of the 2 long longs.
(vector bool long long)( <i>unsigned long long</i> )	A list of 2 boolean 64-bit quantities with a value specified by the single unsigned long long.
(vector bool long long)( <i>unsigned long long</i> , ...) (vector bool long long){ <i>unsigned long long</i> , ...}	A list of 2 boolean 64-bit quantities with a value specified by each of the 2 unsigned long longs.
(vector double)( <i>double</i> )	A list of 2 64-bit IEEE-754 double-precision floating-point quantities that both have the value of the single double.



Table 108. Vector literals (continued)

Syntax	Interpreted by the compiler as
(vector double)(double, double)	A list of 2 64-bit IEEE-754 double-precision floating-point quantities with a value specified by each of the 2 doubles.
(vector double){double, double}	

**Note:** The value of an element in a vector bool is FALSE if each bit of the element is set to 0 and TRUE if each bit of the element is set to 1.

For example, for an unsigned integer vector type, the literal could be either of the following:

```
(vector unsigned int)(10) /* initializes all four elements to a value of 10 */
(vector unsigned int)(14, 82, 73, 700) /* initializes the first element
                                         to 14, the second element to 82,
                                         the third element to 73, and the
                                         fourth element to 700 */
```

You can cast vector literals with the Cast operator(). Enclosing the vector literal to be cast in parentheses can improve the readability of the code. For example, you can use the following code to cast a vector signed int literal to a vector unsigned char literal:

```
(vector unsigned char)((vector signed int)(-1, -1, 0, 0))
```

## Initialization of vectors

A vector type can be initialized by a vector literal, or any expression having the same vector type. For example:

```
vector unsigned int v1;
vector unsigned int v2 = (vector unsigned int)(10);
v1 = v2;
```

A vector type can also be initialized by an initializer list.

### Vector initializer list syntax

```
▶▶ vector_type identifier = { (initializer_list) }; ▶▶
                             [ { initializer_list } ]
```

An initializer list enclosed with parentheses must have the same number of value as the number of elements of the vector type. The number of values in a braced initializer list must be less than or equal to the number of elements of the vector type. Any uninitialized element will be initialized to zero.

The following examples show vector initialization using initializer lists:

```
vector unsigned int v1 = {1}; // initialize the first element (4 bytes) of v1
                             // with 1 and the remaining 3 elements (12 bytes)
                             // with zeros

vector unsigned int v2 = {1,2}; // initialize the first element (4 bytes) of v2
                                // with 1, the next element (4 bytes) with 2,
                                // and the remaining elements (8 bytes) with zeros

vector unsigned int v3 = {1,2,3,4}; // equivalent to the vector literal
                                    // (vector unsigned int) (1,2,3,4)
```

Unlike vector literals, the values in the initializer list do not have to be constant expressions unless the initialized vector variable has static duration. Thus, the following code is valid:

```
int i=1;
int function() { return 2; }
int main()
{
    vector unsigned int v1 = {i, function()};
    return 0;
}
```

## typedef definitions for vector types

With a typedef declaration, you can define your own identifiers that can be used in place of type specifiers.

typedef definitions are extended to handle vector types, provided that vector support is enabled. A vector type can be used in a typedef definition, and the new type name can be used in the usual ways, except for declaring other vectors. In a vector declaration context, a typedef name is disallowed as a type specifier.

The following example illustrates a typical usage of typedef with vector types:

```
typedef vector unsigned short vushort4;
vushort4 v1;
```

For more information about typedef declaration, see typedef definitions in *z/OS XL C/C++ Language Reference*.

## Pointers

If you dereference a pointer to a vector data type, the standard behavior of either a load or a copy of the corresponding type is performed.

Pointer arithmetic can be used on vector data types. The result of the operation `p+1` is a pointer to the next vector after the vector pointed to by `p`.

See Pointers in *z/OS XL C/C++ Language Reference* for general details.

## Unary expressions

Some unary expressions are extended for the vector data types.

### Unary operators ++ -- + - ~

Vector data types can use some of the unary operators that are used with primitive data types, as outlined in the table below. These operators are not supported at global scope or for objects with static duration, and there is no constant folding. Each element in the vector has the operation applied to it.

Table 109. Unary operators

Operator	Integer vector types	Vector double	Bool vector types
++	Yes	Yes	No
--	Yes	Yes	No
+	Yes	Yes	No
-	Yes (except unsigned vectors)	Yes	No
~	Yes	No	Yes

**Note:** Unary minus operator - on vector double will not cause IEEE exception.

For detailed information about unary operators, see *Unary expressions in z/OS XL C/C++ Language Reference*.

### **Address operator &**

The & (address) operator can be used on the vector data types. It yields a pointer to the corresponding vector data type. See *Address operator & in z/OS XL C/C++ Language Reference* for details on the operator.

### **The `__alignof__` operator**

The `__alignof__` operator is a language extension to C99 and Standard C++ that returns the position to which its operand is aligned. See the `__alignof__` operator in the *z/OS XL C/C++ Language Reference* for details.

The operand of `__alignof__` can be a vector type, provided that vector support is enabled. For example,

```
vector unsigned int v1 = (vector unsigned int)(10);
vector unsigned int *pv1 = &v1;
__alignof__(v1); // vector type alignment: 8.
__alignof__(&v1); // address of vector alignment: 4 (with ILP32) or 8 (with LP64).
__alignof__(*pv1); // dereferenced pointer to vector alignment: 8.
__alignof__(pv1); // pointer to vector alignment: 4 (with ILP32) or 8 (with LP64)
__alignof__(vector signed char); // vector type alignment: 8.
```

When `__attribute__((aligned))` is used to increase the alignment of a variable of vector type, the value that is returned by the `__alignof__` operator is the alignment factor that is specified by `__attribute__((aligned))`.

### **The `sizeof` operator**

The `sizeof` operator yields the size in bytes of the operand. See the `sizeof` operator in the *z/OS XL C/C++ Language Reference* for details.

The operand of the `sizeof` operator can be a vector variable, a vector type, or the result of dereferencing a pointer to vector type, provided that vector support is enabled. In these cases, the return value of `sizeof` is always 16. For example,

```
vector bool int v1;
vector bool int *pv1 = &v1;
sizeof(v1); // vector type: 16.
sizeof(&v1); // address of vector: 4 (with ILP32) or 8 (with LP64).
sizeof(*pv1); // dereferenced pointer to vector: 16.
sizeof(pv1); // pointer to vector: 4 (with ILP32) or 8 (with LP64).
sizeof(vector double); // vector type: 16.
```

### **The `typeof` operator**

The `typeof` operator returns the type of its argument, which can be an expression or a type. See the `typeof` operator in the *z/OS XL C/C++ Language Reference* for details.

It is extended to accept a vector type as its operand, when vector support is enabled.

### **The `vec_step` operator**

The `vec_step` operator takes a vector type operand and returns an integer value representing the amount by which a pointer to a vector element should be incremented in order to move by 16 bytes (the size of a vector), or equivalently, the number of elements in the vector. The following table provides a summary of values by data type.

Table 110. Increment value for `vec_step` by data type

vec_step expression	Value
<code>vec_step(vector unsigned char)</code>	16
<code>vec_step(vector signed char)</code>	
<code>vec_step(vector bool char)</code>	
<code>vec_step(vector unsigned short)</code>	8
<code>vec_step(vector signed short)</code>	
<code>vec_step(vector bool short)</code>	
<code>vec_step(vector unsigned int)</code>	4
<code>vec_step(vector signed int)</code>	
<code>vec_step(vector bool int)</code>	
<code>vec_step(vector unsigned long long)</code>	2
<code>vec_step(vector signed long long)</code>	
<code>vec_step(vector bool long long)</code>	
<code>vec_step(vector double)</code>	2

## Binary expressions

Some binary expressions that are used with primitive data types are extended for the vector data types.

For binary operators, each element has the operation applied to it with the same position element in the second operand. Binary operators also include assignment operators.

Table 111. Binary operators

Operator	Integer vector types	Vector double	Bool vector types
<code>*</code>	Yes	Yes	No
<code>/</code>	Yes	Yes	No
<code>%</code>	Yes	No	No
<code>+</code>	Yes	Yes	No
<code>-</code>	Yes	Yes	No
<code>&lt;&lt;</code>	Yes	No	No
<code>&gt;&gt;</code>	Yes	No	No
<code>&amp;</code>	Yes	Yes	Yes
<code>^</code>	Yes	Yes	Yes
<code> </code>	Yes	Yes	Yes
<code>[]</code>	Yes	Yes	Yes

### Notes:

- The `[]` operator returns the vector element at the position specified.
- These operators might not be portable.

For relational operators, each element has the operation applied to it with the same position element in the second operand and the results have the AND operator applied to them to get a final result of a single value. The following table provides a summary on the binary operators that can operate on some of the vector data types.

Table 112. Relational operators

Operator	Integer vector types	Vector double	Bool vector types
==	Yes	Yes	Yes
!=	Yes	Yes	Yes
<	Yes	Yes	No
>	Yes	Yes	No
<=	Yes	Yes	No
>=	Yes	Yes	No

These operators are not supported at global scope or for objects with static duration, and there is no constant folding.

The following sections provide details on each of the supported binary operators with the vector data types. For general detailed information about binary operators, see Binary expressions in *z/OS XL C/C++ Language Reference*.

### Assignment operator =

An assignment operator stores a value in the object designated by the left operand. If either side of an assignment expression is a vector type, both sides of the expression must be of the same vector type. Therefore, the expression `a = b` is valid and represents assignment if `a` and `b` are of the same vector type. Otherwise, the expression is invalid, and the compiler reports an error about inconsistent data types.

### Multiplication operator \*

The `*` (multiplication) operator yields the product of its operands.

**Note:** This function emulates the operation on vector unsigned long long and vector signed long long.

The following table lists the vector data types accepted as the operands, and the corresponding returned vector data types:

Table 113. Accepted vector data types for multiplication operator \*

Result types	Left operand types	Right operand types
vector unsigned char	vector unsigned char	vector unsigned char
vector signed char	vector signed char	vector signed char
vector unsigned short	vector unsigned short	vector unsigned short
vector signed short	vector signed short	vector signed short
vector unsigned int	vector unsigned int	vector unsigned int
vector signed int	vector signed int	vector signed int
vector unsigned long long	vector unsigned long long	vector unsigned long long
vector signed long long	vector signed long long	vector signed long long
vector double	vector double	vector double

## Division operator /

The / (division) operator yields the algebraic quotient of its operands.

**Note:** This function emulates the operation on integer vector types.

The following table lists the vector data types accepted as the operands, and the corresponding returned vector data types:

*Table 114. Accepted vector data types for division operator /*

Result types	Left operand types	Right operand types
vector signed char	vector signed char	vector signed char
vector unsigned char	vector unsigned char	vector unsigned char
vector signed short	vector signed short	vector signed short
vector unsigned short	vector unsigned short	vector unsigned short
vector signed int	vector signed int	vector signed int
vector unsigned int	vector unsigned int	vector unsigned int
vector signed long long	vector signed long long	vector signed long long
vector unsigned long long	vector unsigned long long	vector unsigned long long
vector double	vector double	vector double

## Remainder operator %

The % (remainder) operator yields the remainder from the division of the left operand by the right operand.

The following table lists the vector data types accepted as the operands, and the corresponding returned vector data types:

*Table 115. Accepted vector data types for remainder operator %*

Result types	Left operand types	Right operand types
vector signed char	vector signed char	vector signed char
vector unsigned char	vector unsigned char	vector unsigned char
vector signed short	vector signed short	vector signed short
vector unsigned short	vector unsigned short	vector unsigned short
vector signed int	vector signed int	vector signed int
vector unsigned int	vector unsigned int	vector unsigned int
vector signed long long	vector signed long long	vector signed long long
vector unsigned long long	vector unsigned long long	vector unsigned long long

## Addition operator +

The + (addition) operator yields the sum of its operands.

The following table lists the vector data types accepted as the operands, and the corresponding returned vector data types:

Table 116. Accepted vector data types for addition operator +

Result types	Left operand types	Right operand types
vector signed char	vector signed char	vector signed char
	vector signed char	vector bool char
	vector bool char	vector signed char
vector unsigned char	vector unsigned char	vector unsigned char
	vector unsigned char	vector bool char
	vector bool char	vector unsigned char
vector signed short	vector signed short	vector signed short
	vector signed short	vector bool short
	vector bool short	vector signed short
vector unsigned short	vector unsigned short	vector unsigned short
	vector unsigned short	vector bool short
	vector bool short	vector unsigned short
vector signed int	vector signed int	vector signed int
	vector signed int	vector bool int
	vector bool int	vector signed int
vector unsigned int	vector unsigned int	vector unsigned int
	vector unsigned int	vector bool int
	vector bool int	vector unsigned int
vector signed long long	vector signed long long	vector signed long long
vector unsigned long long	vector unsigned long long	vector unsigned long long
vector double	vector double	vector double

### Subtraction operator -

The - (subtraction) operator yields the difference of its operands.

The following table lists the vector data types accepted as the operands, and the corresponding returned vector data types:

Table 117. Accepted vector data types for subtraction operator -

Result types	Left operand types	Right operand types
vector signed char	vector signed char	vector signed char
	vector signed char	vector bool char
	vector bool char	vector signed char
vector unsigned char	vector unsigned char	vector unsigned char
	vector unsigned char	vector bool char
	vector bool char	vector unsigned char
vector signed short	vector signed short	vector signed short
	vector signed short	vector bool short
	vector bool short	vector signed short

Table 117. Accepted vector data types for subtraction operator - (continued)

Result types	Left operand types	Right operand types
vector unsigned short	vector unsigned short	vector unsigned short
	vector unsigned short	vector bool short
	vector bool short	vector unsigned short
vector signed int	vector signed int	vector signed int
	vector signed int	vector bool int
	vector bool int	vector signed int
vector unsigned int	vector unsigned int	vector unsigned int
	vector unsigned int	vector bool int
	vector bool int	vector unsigned int
vector signed long long	vector signed long long	vector signed long long
vector unsigned long long	vector unsigned long long	vector unsigned long long
vector double	vector double	vector double

### Bitwise left shift operator <<

The << (bitwise left shift operator) performs a left shift for each element of a vector. Each element of the result vector is the result of left shifting the corresponding element of the left operand by the number of bits specified by the value specified on the right operand, or the value of the corresponding element of the right operand, modulo the number of bits in the element. The bits that are shifted out are replaced by zeros.

The following table lists the vector data types accepted as the operands, and the corresponding returned vector data types:

Table 118. Accepted vector data types for bitwise left shift operator <<

Result types	Left operand types	Right operand types
vector unsigned char	vector unsigned char	vector unsigned char
vector signed char	vector signed char	
vector unsigned short	vector unsigned short	vector unsigned short
vector signed short	vector signed short	
vector unsigned int	vector unsigned int	vector unsigned int
vector signed int	vector signed int	
vector unsigned long long	vector unsigned long long	vector unsigned long long
vector signed long long	vector signed long long	
vector unsigned char	vector unsigned char	unsigned long
vector signed char	vector signed char	
vector unsigned short	vector unsigned short	unsigned long
vector signed short	vector signed short	
vector unsigned int	vector unsigned int	unsigned long
vector signed int	vector signed int	
vector unsigned long long	vector unsigned long long	unsigned long
vector signed long long	vector signed long long	



## Bitwise right shift operator >>

The >> (bitwise right shift operator) performs a logical or an algebraic right shift for each element of a vector. Each element of the result vector is the result of right shifting the corresponding element of the left operand by the number of bits specified by the value of the corresponding element of the right operand, modulo the number of bits in the element. When the right operand is an unsigned vector type, the bits that are shifted out are replaced by zeroes. While if the left operand is a signed vector type, the bits that are shifted out are replaced by copies of the most significant bit of the element of the left operand.

The following table lists the vector data types accepted as the operands, and the corresponding returned vector data types:

Table 119. Accepted vector data types for bitwise right shift operator >>

Result types	Left operand types	Right operand types
vector unsigned char	vector unsigned char	vector unsigned char
vector unsigned short	vector unsigned short	vector unsigned short
vector unsigned int	vector unsigned int	vector unsigned int
vector unsigned long long	vector unsigned long long	vector unsigned long long
vector unsigned char	vector unsigned char	unsigned long
vector unsigned short	vector unsigned short	unsigned long
vector unsigned int	vector unsigned int	unsigned long
vector unsigned long long	vector unsigned long long	unsigned long
vector signed char	vector signed char	vector signed char vector unsigned char
vector signed short	vector signed short	vector signed short vector unsigned short
vector signed int	vector signed int	vector signed int vector unsigned int
vector signed long long	vector signed long long	vector signed long long vector unsigned long long
vector signed char	vector signed char	unsigned long
vector signed short	vector signed short	unsigned long
vector signed int	vector signed int	unsigned long
vector signed long long	vector signed long long	unsigned long

## Relational less than operator <

The < (relational less than operator) tests whether all elements of the left operand are less than the corresponding elements of the right operand. The result is 1 if all elements of the left operand are less than the corresponding elements of the right operand. Otherwise, the result is 0.

**Note:** A signed comparison is performed, if either of the operands is a signed integer vector.

The following table lists the vector data types accepted as the operands:

Table 120. Accepted vector data types for relational less than operator <

Left operand types	Right operand types
vector bool char	vector bool char
	vector signed char
	vector unsigned char
vector signed char	vector bool char
	vector signed char
vector unsigned char	vector bool char
	vector unsigned char
vector bool short	vector bool short
	vector signed short
	vector unsigned short
vector signed short	vector bool short
	vector signed short
vector unsigned short	vector bool short
	vector unsigned short
vector bool int	vector bool int
	vector signed int
	vector unsigned int
vector signed int	vector bool int
	vector signed int
vector unsigned int	vector bool int
	vector unsigned int
vector bool long long	vector bool long long
	vector signed long long
	vector unsigned long long
vector signed long long	vector bool long long
	vector signed long long
vector unsigned long long	vector bool long long
	vector unsigned long long
vector double	vector double

### Relational greater than operator >

The > (relational greater than operator) tests whether all elements of the left operand are greater than the corresponding elements of the right operand. The result is 1 if all elements of the left operand are greater than the corresponding elements of the right operand. Otherwise, the result is 0.

**Note:** A signed comparison is performed, if either of the operands is a signed integer vector.

The following table lists the vector data types accepted as the operands:

Table 121. Accepted vector data types for relational greater than operator >

Left operand types	Right operand types
vector bool char	vector bool char
	vector signed char
	vector unsigned char
vector signed char	vector bool char
	vector signed char
vector unsigned char	vector bool char
	vector unsigned char
vector bool short	vector bool short
	vector signed short
	vector unsigned short
vector signed short	vector bool short
	vector signed short
vector unsigned short	vector bool short
	vector unsigned short
vector bool int	vector bool int
	vector signed int
	vector unsigned int
vector signed int	vector bool int
	vector signed int
vector unsigned int	vector bool int
	vector unsigned int
vector bool long long	vector bool long long
	vector signed long long
	vector unsigned long long
vector signed long long	vector bool long long
	vector signed long long
vector unsigned long long	vector bool long long
	vector unsigned long long
vector double	vector double

### Relational less than or equal to operator <=

The <= (relational less than or equal to operator) tests whether all elements of the left operand are less than or equal to the corresponding elements of the right operand. The result is 1 if all elements of the left operand are less than or equal to the corresponding elements of the right operand. Otherwise, the result is 0.

**Note:** A signed comparison is performed, if either of the operands is a signed integer vector.

The following table lists the vector data types accepted as the operands:

Table 122. Accepted vector data types for relational less than or equal to operator <=

Left operand types	Right operand types
vector bool char	vector bool char
	vector signed char
	vector unsigned char
vector signed char	vector bool char
	vector signed char
vector unsigned char	vector bool char
	vector unsigned char
vector bool short	vector bool short
	vector signed short
	vector unsigned short
vector signed short	vector bool short
	vector signed short
vector unsigned short	vector bool short
	vector unsigned short
vector bool int	vector bool int
	vector signed int
	vector unsigned int
vector signed int	vector bool int
	vector signed int
vector unsigned int	vector bool int
	vector unsigned int
vector bool long long	vector bool long long
	vector signed long long
	vector unsigned long long
vector signed long long	vector bool long long
	vector signed long long
vector unsigned long long	vector bool long long
	vector unsigned long long
vector double	vector double

### Relational greater than or equal to operator >=

The >= (relational greater than or equal to operator) tests whether all elements of the left operand are greater than or equal to the corresponding elements of the right operand. The result is 1 if all elements of the left operand are greater than or equal to the corresponding elements of the right operand. Otherwise, the result is 0.

**Note:** A signed comparison is performed, if either of the operands is a signed integer vector.

The following table lists the vector data types accepted as the operands:

Table 123. Accepted vector data types for relational greater than or equal to operator >=

Left operand types	Right operand types
vector bool char	vector bool char
	vector signed char
	vector unsigned char
vector signed char	vector bool char
	vector signed char
vector unsigned char	vector bool char
	vector unsigned char
vector bool short	vector bool short
	vector signed short
	vector unsigned short
vector signed short	vector bool short
	vector signed short
vector unsigned short	vector bool short
	vector unsigned short
vector bool int	vector bool int
	vector signed int
	vector unsigned int
vector signed int	vector bool int
	vector signed int
vector unsigned int	vector bool int
	vector unsigned int
vector bool long long	vector bool long long
	vector signed long long
	vector unsigned long long
vector signed long long	vector bool long long
	vector signed long long
vector unsigned long long	vector bool long long
	vector unsigned long long
vector double	vector double

### Equality operator ==

The == (equality operator) tests whether all sets of corresponding elements of the given vectors are equal. The result is 1 if each element of the left operand is equal to the corresponding element of the right operand. Otherwise, the result is 0.

The following table lists the vector data types accepted as the operands:

Table 124. Accepted vector data types for equality operator ==

Left operand types	Right operand types
vector bool char	vector bool char
	vector signed char
	vector unsigned char

Table 124. Accepted vector data types for equality operator == (continued)

Left operand types	Right operand types
vector signed char	vector bool char
	vector signed char
vector unsigned char	vector bool char
	vector unsigned char
vector bool short	vector bool short
	vector signed short
	vector unsigned short
vector signed short	vector bool short
	vector signed short
vector unsigned short	vector bool short
	vector unsigned short
vector bool int	vector bool int
	vector signed int
	vector unsigned int
vector signed int	vector bool int
	vector signed int
vector unsigned int	vector bool int
	vector unsigned int
vector bool long long	vector bool long long
	vector signed long long
	vector unsigned long long
vector signed long long	vector bool long long
	vector signed long long
vector unsigned long long	vector bool long long
	vector unsigned long long
vector double	vector double

### Inequality operator !=

The != (inequality operator) tests whether all sets of corresponding elements of the given vectors are not equal. The result is 1 if each element of the left operand is not equal to the corresponding element of the right operand. Otherwise, the result is 0.

The following table lists the vector data types accepted as the operands:

Table 125. Accepted vector data types for inequality operator !=

Left operand types	Right operand types
vector bool char	vector bool char
	vector signed char
	vector unsigned char
vector signed char	vector bool char
	vector signed char

Table 125. Accepted vector data types for inequality operator != (continued)

Left operand types	Right operand types
vector unsigned char	vector bool char
	vector unsigned char
vector bool short	vector bool short
	vector signed short
	vector unsigned short
vector signed short	vector bool short
	vector signed short
vector unsigned short	vector bool short
	vector unsigned short
vector bool int	vector bool int
	vector signed int
	vector unsigned int
vector signed int	vector bool int
	vector signed int
vector unsigned int	vector bool int
	vector unsigned int
vector bool long long	vector bool long long
	vector signed long long
	vector unsigned long long
vector signed long long	vector bool long long
	vector signed long long
vector unsigned long long	vector bool long long
	vector unsigned long long
vector double	vector double

### Bitwise AND operator &

The & (bitwise AND) operator compares each bit of its first operand to the corresponding bit of the second operand.

The following table lists the vector data types accepted as the operands, and the corresponding returned vector data types:

Table 126. Accepted vector data types for bitwise AND operator &

Result types	Left operand types	Right operand types
vector bool char	vector bool char	vector bool char
vector signed char	vector bool char	vector signed char
	vector signed char	vector signed char
		vector bool char
vector unsigned char	vector bool char	vector unsigned char
	vector unsigned char	vector unsigned char
		vector bool char
vector bool short	vector bool short	vector vector bool short

Table 126. Accepted vector data types for bitwise AND operator & (continued)

Result types	Left operand types	Right operand types
vector signed short	vector bool short	vector signed short
	vector signed short	vector signed short
		vector bool short
vector unsigned short	vector bool short	vector unsigned short
	vector unsigned short	vector unsigned short
		vector bool short
vector bool int	vector bool int	vector bool int
vector signed int	vector bool int	vector signed int
	vector signed int	vector signed int
		vector bool int
vector unsigned int	vector bool int	vector unsigned int
	vector unsigned int	vector unsigned int
		vector bool int
vector bool long long	vector bool long long	vector bool long long
vector signed long long	vector bool long long	vector signed long long
	vector signed long long	vector signed long long
		vector bool long long
vector unsigned long long	vector bool long long	vector unsigned long long
	vector unsigned long long	vector unsigned long long
		vector bool long long
vector double	vector bool long long	vector double
	vector double	vector double
		vector bool long long

### Bitwise exclusive OR operator ^

The ^ (bitwise exclusive OR) operator compares each bit of its first operand to the corresponding bit of the second operand.

**Note:** vector double will not cause IEEE exception.

The following table lists the vector data types accepted as the operands, and the corresponding returned vector data types:

Table 127. Accepted vector data types for bitwise exclusive OR operator ^

Result types	Left operand types	Right operand types
vector bool char	vector bool char	vector bool char
vector signed char	vector bool char	vector signed char
	vector signed char	vector signed char
		vector bool char
vector unsigned char	vector bool char	vector unsigned char
	vector unsigned char	vector unsigned char
		vector bool char



Table 127. Accepted vector data types for bitwise exclusive OR operator ^ (continued)

Result types	Left operand types	Right operand types
vector bool short	vector bool short	vector vector bool short
vector signed short	vector bool short	vector signed short
	vector signed short	vector signed short
		vector bool short
vector unsigned short	vector bool short	vector unsigned short
	vector unsigned short	vector unsigned short
		vector bool short
vector bool int	vector bool int	vector bool int
vector signed int	vector bool int	vector signed int
	vector signed int	vector signed int
		vector bool int
vector unsigned int	vector bool int	vector unsigned int
	vector unsigned int	vector unsigned int
		vector bool int
vector bool long long	vector bool long long	vector bool long long
vector signed long long	vector bool long long	vector signed long long
	vector signed long long	vector signed long long
		vector bool long long
vector unsigned long long	vector bool long long	vector unsigned long long
	vector unsigned long long	vector unsigned long long
		vector bool long long
vector double	vector bool long long	vector double
	vector double	vector double
		vector bool long long

## Bitwise inclusive OR operator |

The | (bitwise inclusive OR) operator compares the values (in binary format) of each operand and yields a value whose bit pattern shows which bits in either of the operands has the value 1.

**Note:** vector double will not cause IEEE exception.

The following table lists the vector data types accepted as the operands, and the corresponding returned vector data types:

Table 128. Accepted vector data types for bitwise inclusive OR operator |

Result types	Left operand types	Right operand types
vector bool char	vector bool char	vector bool char
vector signed char	vector bool char	vector signed char
	vector signed char	vector signed char
		vector bool char

Table 128. Accepted vector data types for bitwise inclusive OR operator | (continued)

Result types	Left operand types	Right operand types
vector unsigned char	vector bool char	vector unsigned char
	vector unsigned char	vector unsigned char
		vector bool char
vector bool short	vector bool short	vector vector bool short
vector signed short	vector bool short	vector signed short
	vector signed short	vector signed short
		vector bool short
vector unsigned short	vector bool short	vector unsigned short
	vector unsigned short	vector unsigned short
		vector bool short
vector bool int	vector bool int	vector bool int
vector signed int	vector bool int	vector signed int
	vector signed int	vector signed int
		vector bool int
vector unsigned int	vector bool int	vector unsigned int
	vector unsigned int	vector unsigned int
		vector bool int
vector bool long long	vector bool long long	vector bool long long
vector signed long long	vector bool long long	vector signed long long
	vector signed long long	vector signed long long
		vector bool long long
vector unsigned long long	vector bool long long	vector unsigned long long
	vector unsigned long long	vector unsigned long long
		vector bool long long
vector double	vector bool long long	vector double
	vector double	vector bool long long
		vector double

### Vector subscripting operator []

The [] (subscripting) operator accesses individual elements of a vector data type, similar to how array elements are accessed. The vector data type is followed by a set of square brackets containing the position of the element. The position of the first element is 0. The type of the result is the type of the elements contained in the vector type.

**Note:** If the position specified is outside of the valid range, the behavior is undefined.

Example:

```
vector unsigned int v1 = {1,2,3,4};
unsigned int u1, u2, u3, u4;
u1 = v1[0]; // u1=1
u2 = v1[1]; // u2=2
u3 = v1[2]; // u3=3
u4 = v1[3]; // u4=4
```

**Note:** You can also access and manipulate individual elements of vectors with the following intrinsic functions:

- `vec_extract`
- `vec_insert`
- `vec_promote`
- `vec_splats`

## Cast expressions

The cast operator () is extended to support explicit type conversions from one vector data type to another vector data type. The exact same bit pattern is retained from the cast, and no conversion of the vector elements value takes place.

C++ `static_cast` is also extended to support type conversions between different vector types, just explicit cast operator ().

Casting between any scalar types and vector types are not allowed. To manipulate a vector element, the vector subscripting operator [], or the set of gather and scatter vector built-in functions should be used.

For more general information about casting, See Cast expression in *z/OS XL C/C++ Language Reference*.

## Compound literal expressions

A *compound literal* is a postfix expression that provides an unnamed object whose value is given by an initializer list. The C99 language feature allows you to pass parameters to functions without the need for temporary variables.

A static vector variable can be initialized with a compound literal of the same type, provided that all the initializers in the initializer list are constant expressions.

For more general information about compound literal expressions, see Compound literal expressions in *z/OS XL C/C++ Language Reference*.

## Other extensions for vector types

The following runtime library functions are also extended to support vector processing:

- `setjmp()` — Preserve stack environment
- `longjmp()` — Restore stack environment
- `fprintf()`, `printf()`, `sprintf()` — Format and write data
- `fscanf()`, `scanf()`, `sscanf()` — Read and format data
- `va_arg()`, `va_copy()`, `va_end()`, `va_start()` — Access function arguments

For detailed information about these runtime library functions, see *z/OS XL C/C++ Runtime Library Reference*.

---

## Vector built-in functions

Individual elements of vectors can be accessed and manipulated by using the vector built-in functions. You must enable the vector support to use these built-in functions. This section provides description of the supported vector built-in functions.

This section uses pseudo code description to represent the built-in function syntax, as shown below:

```
d = builtin_name(a, b, c)
```

In the description,

- d represents the return value of the built-in function.
- a, b, and c represent the arguments of the built-in function.
- builtin\_name is the name of the built-in function.

For example, the syntax for the built-in function `vector double vec_xld2(long, double*)`; is represented by `d = vec_xld2(a, b)`.

Allowed data types for the return value and arguments of the built-in functions are provided in the table after the description of the built-in functions.

### Header file

To use the vector built-in functions, you must include `builtins.hand` compile the program with the `LANGLVL(EXTENDED)` or `LANGLVL(LIBEXT)` option.

**Note:** The vector built-in functions are only visible when vector support is enabled. In addition, the vector built-in functions with `vector bool long long`, `vector signed long long`, or `vector unsigned long long` require the `LANGLVL(LONGLONG)` compiler option in effect to be visible, and the vector built-in functions with `vector double` require the `FLOAT(IEEE)` compiler option in effect to be visible.

### Summary of vector built-in functions

The tables below summarize and categorize the vector built-in functions.

#### Arithmetic

Table 129. Vector built-in functions for arithmetic

Function name	Short name description	More information
<code>vec_abs</code>	Vector Absolute Value	See detail
<code>vec_add_u128</code>	Vector Add unsigned 128-bits	See detail
<code>vec_addc</code>	Vector Add Carryout	See detail
<code>vec_addc_u128</code>	Vector Add Compute Carryout unsigned 128-bits	See detail
<code>vec_adde_u128</code>	Vector Add With Carry unsigned 128-bits	See detail
<code>vec_addec_u128</code>	Vector Add With Carry Compute Carry unsigned 128-bits	See detail
<code>vec_andc</code>	Vector AND With Complement	See detail
<code>vec_avg</code>	Vector Average	See detail

Table 129. Vector built-in functions for arithmetic (continued)

Function name	Short name description	More information
vec_checksum	Vector Checksum	See detail
vec_gfmsum	Vector Galois Field Multiply Sum	See detail
vec_gfmsum_128	Vector Galois Field Multiply Sum 128-bits	See detail
vec_gfmsum_accum	Vector Galois Field Multiply Sum and Accumulate	See detail
vec_gfmsum_accum_128	Vector Galois Field Multiply Sum and Accumulate 128-bits	See detail
vec_madd	Vector Multiply Add	See detail
vec_max	Vector Maximum	See detail
vec_meadd	Vector Multiply and Add Even	See detail
vec_mhadd	Vector Multiply and Add High	See detail
vec_min	Vector Minimum	See detail
vec_mladd	Vector Multiply and Add Low	See detail
vec_moadd	Vector Multiply and Add Odd	See detail
vec_msub	Vector Multiply Subtract	See detail
vec_mule	Vector Multiply Even	See detail
vec_mulh	Vector Multiply High	See detail
vec_mulo	Vector Multiply Odd	See detail
vec_nabs	Vector Negative Absolute	See detail
vec_sqrt	Vector Square Root	See detail
vec_sub_u128	Vector Subtract unsigned 128-bits	See detail
vec_subc	Vector Subtract Carryout	See detail
vec_subc_u128	Vector Subtract Carryout unsigned 128-bits	See detail
vec_sube_u128	Vector Subtract with Carryout	See detail
vec_subec_u128	Vector Subtract with Carryout, Carryout	See detail
vec_sum_u128	Vector Sum Across Quadword	See detail
vec_sum2	Vector Sum Across Doubleword	See detail
vec_sum4	Vector Sum Across Word	See detail

## Compare

Table 130. Vector built-in functions for comparing elements

Function name	Short name description	More information
vec_cmpeq	Vector Compare Equal	See detail
vec_cmpeq_idx	Vector Compare Equal Index	See detail
vec_cmpeq_idx_cc	Vector Compare Equal Index with Condition Code	See detail
vec_cmpeq_or_0_idx	Vector Compare Equal or Zero Index	See detail

Table 130. Vector built-in functions for comparing elements (continued)

Function name	Short name description	More information
vec_cmpeq_or_0_idx_cc	Vector Compare Equal or Zero Index with Condition Code	See detail
vec_cmpge	Vector Compare Greater Than or Equal	See detail
vec_cmpgt	Vector Compare Greater Than	See detail
vec_cmple	Vector Compare Less Than or Equal	See detail
vec_cmplt	Vector Compare Less Than	See detail
vec_cmpne_idx	Vector Compare Not Equal Index	See detail
vec_cmpne_idx_cc	Vector Compare Not Equal Index with Condition Code	See detail
vec_cmpne_or_0_idx	Vector Compare Not Equal or Zero Index	See detail
vec_cmpne_or_0_idx_cc	Vector Compare Not Equal or Zero Index with Condition Code	See detail

## Compare Ranges

Table 131. Vector built-in functions for comparing ranges

Function name	Short name description	More information
vec_cmpnrg	Vector Compare Not in Ranges	See detail
vec_cmpnrg_cc	Vector Compare Not in Ranges with Condition Code	See detail
vec_cmpnrg_idx	Vector Compare Not in Ranges Index	See detail
vec_cmpnrg_idx_cc	Vector Compare Not in Ranges Index with Condition Code	See detail
vec_cmpnrg_or_0_idx	Vector Compare Not in Ranges or Zero Index	See detail
vec_cmpnrg_or_0_idx_cc	Vector Compare Not in Ranges or Zero Index with Condition Code	See detail
vec_cmprg	Vector Compare Ranges	See detail
vec_cmprg_cc	Vector Compare Ranges with Condition Code	See detail
vec_cmprg_idx	Vector Compare Ranges Index	See detail
vec_cmprg_idx_cc	Vector Compare Ranges Index with Condition Code	See detail
vec_cmprg_or_0_idx	Vector Compare Ranges or Zero Index	See detail
vec_cmprg_or_0_idx_cc	Vector Compare Ranges or Zero Index with Condition Code	See detail

## Find Any Element

Table 132. Vector built-in functions for element searching

Function name	Short name description	More information
vec_find_any_eq	Vector Find Any Element Equal	See detail

Table 132. Vector built-in functions for element searching (continued)

Function name	Short name description	More information
vec_find_any_eq_cc	Vector Find Any Element Equal with Condition Code	See detail
vec_find_any_eq_idx	Vector Find Any Element Equal Index	See detail
vec_find_any_eq_idx_cc	Vector Find Any Element Equal Index with Condition Code	See detail
vec_find_any_eq_or_0_idx	Vector Find Any Element Equal or Zero Index	See detail
vec_find_any_eq_or_0_idx_cc	Vector Find Any Element Equal or Zero Index with Condition Code	See detail
vec_find_any_ne	Vector Find Any Element Not Equal	See detail
vec_find_any_ne_cc	Vector Find Any Element Not Equal with Condition Code	See detail
vec_find_any_ne_idx	Vector Find Any Element Not Equal Index	See detail
vec_find_any_ne_idx_cc	Vector Find Any Element Not Equal Index with Condition Code	See detail
vec_find_any_ne_or_0_idx	Vector Find Any Element Not Equal or Zero Index	See detail
vec_find_any_ne_or_0_idx_cc	Vector Find Any Element Not Equal or Zero Index with Condition Code	See detail

## Gather and Scatter

Table 133. Vector built-in functions for gathering and scattering elements

Function name	Short name description	More information
vec_extract	Vector Extract	See detail
vec_gather_element	Vector Gather Element	See detail
vec_insert	Vector Insert	See detail
vec_insert_and_zero	Vector Insert and Zero	See detail
vec_perm	Vector Permute	See detail
vec_permi	Vector Permute Immediate	See detail
vec_promote	Vector Promote	See detail
vec_scatter_element	Vector Scatter Element	See detail
vec_sel	Vector Select	See detail

## Generate Mask

Table 134. Vector built-in functions for generating mask

Function name	Short name description	More information
vec_genmask	Vector Generate Byte Mask	See detail
vec_genmasks_8	Vector Generate Mask (Byte)	See detail
vec_genmasks_16	Vector Generate Mask (Halfword)	See detail

Table 134. Vector built-in functions for generating mask (continued)

Function name	Short name description	More information
vec_genmasks_32	Vector Generate Mask (Word)	See detail
vec_genmasks_64	Vector Generate Mask (Doubleword)	See detail

## Copy until Zero

Table 135. Vector built-in functions for copying until a zero is encountered

Function name	Short name description	More information
vec_cp_until_zero	Vector Copy Until Zero	See detail
vec_cp_until_zero_cc	Vector Copy Until Zero	See detail

## Load and Store

Table 136. Vector built-in functions for loading and storing vectors

Function name	Short name description	More information
vec_ld2f	Vector Load 2 float	See detail
vec_load_bndry	Vector Load to Block Boundary	See detail
vec_load_len	Vector Load with Length	See detail
vec_load_pair	Vector Load Pair	See detail
vec_st2f	Vector Store 2 float	See detail
vec_store_len	Vector Store with Length	See detail
vec_xld2	Vector Load 2 Doubleword	See detail
vec_xlw4	Vector Load 4 Word	See detail
vec_xstd2	Vector Store 2 Doubleword	See detail
vec_xstw4	Vector Store 4 Word	See detail

## Logical

Table 137. Vector built-in functions for logical calculation

Function name	Short name description	More information
vec_cntlz	Vector Count Leading Zeros	See detail
vec_cnttz	Vector Count Trailing Zeros	See detail
vec_nor	Vector NOR	See detail
vec_popcnt	Vector Population Count	See detail

## Merge

Table 138. Vector built-in functions for merging vectors

Function name	Short name description	More information
vec_mergeh	Vector Merge High	See detail



Table 138. Vector built-in functions for merging vectors (continued)

Function name	Short name description	More information
vec_mergel	Vector Merge Low	See detail

## Pack and Unpack

Table 139. Vector built-in functions for pack and unpack

Function name	Short name description	More information
vec_pack	Vector Pack	See detail
vec_packs	Vector Pack Saturate	See detail
vec_packs_cc	Vector Pack Saturate Condition Code	See detail
vec_packsu	Vector Pack Saturated Unsigned	See detail
vec_packsu_cc	Vector Pack Saturated Unsigned Condition Code	See detail
vec_unpackh	Vector Unpack High Element	See detail
vec_unpackl	Vector Unpack Low Element	See detail

## Replicate

Table 140. Vector built-in functions for replicating vector elements

Function name	Short name description	More information
vec_splat	Vector Splat	See detail
vec_splat_s8	Vector Splat Signed Byte	See detail
vec_splat_s16	Vector Splat Signed Halfword	See detail
vec_splat_s32	Vector Splat Signed Word	See detail
vec_splat_s64	Vector Splat Signed Doubleword	See detail
vec_splat_u8	Vector Splat Unsigned Byte	See detail
vec_splat_u16	Vector Splat Unsigned Halfword	See detail
vec_splat_u32	Vector Splat Unsigned Word	See detail
vec_splat_u64	Vector Splat Doubleword	See detail
vec_splats	Vector Splats	See detail

## Rotate and Shift

Table 141. Vector built-in functions for rotate and shift

Function name	Short name description	More information
vec_rl	Vector Element Rotate Left	See detail
vec_rl_mask	Vector Element Rotate and Insert Under Mask	See detail
vec_rli	Vector Element Rotate Left Immediate	See detail
vec_slb	Vector Shift Left by Byte	See detail
vec_sld	Vector Shift Left Double by Byte	See detail

Table 141. Vector built-in functions for rotate and shift (continued)

Function name	Short name description	More information
vec_sldw	Vector Shift Left Double by Word	See detail
vec_sll	Vector Shift Left	See detail
vec_srab	Vector Shift Right Arithmetic by Byte	See detail
vec_sral	Vector Shift Right Arithmetic	See detail
vec_srb	Vector Shift Right by Byte	See detail
vec_srl	Vector Shift Right	See detail

## Rounding and Conversion

Table 142. Vector built-in functions for rounding and conversion

Function name	Short name description	More information
vec_ceil	Vector Ceiling	See detail
vec_ctd	Vector Convert to Double	See detail
vec_ctsl	Vector Convert to signed long long	See detail
vec_ctul	Vector Convert to unsigned long long	See detail
vec_extend_s64	Vector Sign Extend to Doubleword	See detail
vec_floor	Vector Floor	See detail
vec_round	Vector Round to Nearest	See detail
vec_roundc	Vector Round to Current	See detail
vec_roundm	Vector Round toward Negative Infinity	See detail
vec_roundp	Vector Round toward Positive Infinity	See detail
vec_roundz	Vector Round toward Zero	See detail
vec_trunc	Vector Truncate	See detail

## Test

Table 143. Vector built-in functions for testing

Function name	Short name description	More information
vec_fp_test_data_class	Vector Floating-Point Test Data Class	See detail
vec_test_mask	Vector Test under Mask	See detail

## All Predicates

Table 144. Vector built-in functions for searching and comparing all elements

Function name	Short name description	More information
vec_all_eq	All Elements Equal	See detail
vec_all_ge	All Elements Greater Than or Equal	See detail
vec_all_gt	All Elements Greater Than	See detail
vec_all_le	All Elements Less Than or Equal	See detail

Table 144. Vector built-in functions for searching and comparing all elements (continued)

Function name	Short name description	More information
vec_all_lt	All Elements Less Than	See detail
vec_all_nan	All Elements Not a Number	See detail
vec_all_ne	All Elements Not Equal	See detail
vec_all_nge	All Elements Not Greater Than or Equal	See detail
vec_all_ngt	All Elements Not Greater Than	See detail
vec_all_nle	All Elements Not Less Than or Equal	See detail
vec_all_nlt	All Elements Not Less Than	See detail
vec_all_numeric	All Elements Numeric	See detail

## Any Predicates

Table 145. Vector built-in functions for searching and comparing any elements

Function name	Short name description	More information
vec_any_eq	Any Element Equal	See detail
vec_any_ge	Any Element Greater Than or Equal	See detail
vec_any_gt	Any Element Greater Than	See detail
vec_any_le	Any Element Less Than or Equal	See detail
vec_any_lt	Any Element Less Than	See detail
vec_any_nan	Any Element Not a Number	See detail
vec_any_ne	Any Element Not Equal	See detail
vec_any_nge	Any Element Not Greater Than or Equal	See detail
vec_any_ngt	Any Element Not Greater Than	See detail
vec_any_nle	Any Element Not Less Than or Equal	See detail
vec_any_nlt	Any Element Not Less Than	See detail
vec_any_numeric	Any Element Numeric	See detail

## Arithmetic

This section describes built-in functions for arithmetic.

### vec\_abs: Vector Absolute Value

$d = \text{vec\_abs}(a)$

Returns a vector containing the absolute values of the contents of the given vector. The value of each element of the result is the absolute value of the corresponding element of *a*.

**Note:** vector double will not cause IEEE exception.

Table 146. Vector Absolute Value

<b>d</b>	<b>a</b>
vector signed char	vector signed char
vector signed short	vector signed short

Table 146. Vector Absolute Value (continued)

d	a
vector signed int	vector signed int
vector signed long long	vector signed long long
vector double	vector double

### vec\_add\_u128: Vector Add unsigned 128-bits

d = vec\_add\_u128(a, b)

Adds unsigned quadword values.

The function operates on vectors as 128-bit unsigned integers. It returns low 128 bits of a + b.

Table 147. Vector Add unsigned 128-bits

d	a	b
vector unsigned char	vector unsigned char	vector unsigned char

### vec\_addc: Vector Add Carryout

d = vec\_addc(a, b)

Returns a vector containing the carry produced by adding each set of corresponding elements of the given vectors.

Each resulting element is set to 1 if there is a carry, and 0 otherwise.

Table 148. Vector Add Carryout

d	a	b
vector unsigned char	vector unsigned char	vector unsigned char
vector unsigned short	vector unsigned short	vector unsigned short
vector unsigned int	vector unsigned int	vector unsigned int
vector unsigned long long	vector unsigned long long	vector unsigned long long

### vec\_addc\_u128: Vector Add Compute Carryout unsigned 128-bits

d = vec\_addc\_u128(a, b)

Gets the carry bit of the 128-bit addition of two quadword values.

This function operates on the vectors as 128-bit unsigned integers. It returns the carry out of a + b.

If there is a carry on the addition, the 127-bit of d is set to 1, otherwise 0. All other bits of d are 0.

Table 149. Vector Add Compute Carryout unsigned 128-bits

d	a	b
vector unsigned char	vector unsigned char	vector unsigned char

### **vec\_adde\_u128: Vector Add With Carry unsigned 128-bits**

`d = vec_adde_u128(a, b, c)`

Adds unsigned quadword values with carry bit from the previous operation.

This function operates on the vectors as 128-bit unsigned integers. It returns low 128 bits of  $a + b + (c \& 1)$ .

**Note:** Only the carry bit (127-bit) of *c* is used, and the other bits are ignored.

*Table 150. Vector Add With Carry unsigned 128-bits*

<b>d</b>	<b>a</b>	<b>b</b>	<b>c</b>
vector unsigned char	vector unsigned char	vector unsigned char	vector unsigned char

### **vec\_addec\_u128: Vector Add With Carry Compute Carry unsigned 128-bits**

`d = vec_addec_u128(a, b, c)`

Gets the carry bit of the 128-bit addition of two quadword values with carry bit from a previous operation.

This function operates on the vectors as 128-bit unsigned integers. It returns the carry out of  $a + b + (c \& 1)$ .

If there is a carry on this addition, the 127-bit of *d* is 1, otherwise 0. All other bits of *d* are 0.

**Note:** Only the carry bit (127-bit) of *c* is used, and the other bits are ignored.

*Table 151. Vector Add With Carry Compute Carry unsigned 128-bits*

<b>d</b>	<b>a</b>	<b>b</b>	<b>c</b>
vector unsigned char	vector unsigned char	vector unsigned char	vector unsigned char

### **vec\_andc: Vector AND With Complement**

`d = vec_andc(a, b)`

Returns the bitwise AND of the first argument *a* with the bitwise complement of the second argument *b*.

*Table 152. Vector AND With Complement*

<b>d</b>	<b>a</b>	<b>b</b>
vector bool char	vector bool char	vector bool char
vector signed char	vector bool char	vector signed char
	vector signed char	vector signed char
		vector bool char
vector unsigned char	vector bool char	vector unsigned char
	vector unsigned char	vector unsigned char
		vector bool char
vector bool short	vector bool short	vector bool short

Table 152. Vector AND With Complement (continued)

d	a	b
vector signed short	vector bool short	vector signed short
	vector signed short	vector signed short
		vector bool short
vector unsigned short	vector bool short	vector unsigned short
	vector unsigned short	vector unsigned short
		vector bool short
vector bool int	vector bool int	vector bool int
vector signed int	vector bool int	vector signed int
	vector signed int	vector signed int
		vector bool int
vector unsigned int	vector bool int	vector unsigned int
	vector unsigned int	vector unsigned int
		vector bool int
vector bool long long	vector bool long long	vector bool long long
vector signed long long	vector bool long long	vector signed long long
	vector signed long long	vector signed long long
		vector bool long long
vector unsigned long long	vector bool long long	vector unsigned long long
	vector unsigned long long	vector unsigned long long
		vector bool long long
vector double	vector bool long long	vector double
	vector double	vector bool long long
		vector double

### vec\_avg: Vector Average

$d = \text{vec\_avg}(a, b)$

Returns a vector containing the average of each set of the corresponding elements of the given vectors.

Table 153. Vector Average

d	a	b
vector signed char	vector signed char	vector signed char
vector signed short	vector signed short	vector signed short
vector signed int	vector signed int	vector signed int
vector signed long long	vector signed long long	vector signed long long
vector unsigned char	vector unsigned char	vector unsigned char
vector unsigned short	vector unsigned short	vector unsigned short
vector unsigned int	vector unsigned int	vector unsigned int
vector unsigned long long	vector unsigned long long	vector unsigned long long

### **vec\_checksum: Vector Checksum**

d = vec\_checksum(a, b)

Returns a vector with the 1-indexed element containing a checksum computed from the summation of all vector elements in a and the 1-indexed element of b. All other vector elements will be 0.

*Table 154. Vector Checksum*

d	a	b
vector unsigned int	vector unsigned int	vector unsigned int

### **vec\_gfmsum: Vector Galois Field Multiply Sum**

d = vec\_gfmsum(a, b)

Performs a Galois field multiply sum on each element of the given vectors.

Each element of a is multiplied in a Galois field with the corresponding element of b. The Galois field has an order of two. This multiplication is similar to standard binary multiplication, but instead of adding the shifted multiplicand it is exclusive ORed. The resulting even-odd pairs of double element-sized products are exclusive ORed with each other and placed in the corresponding double-wide element of the returned vector.

*Table 155. Vector Galois Field Multiply Sum*

d	a	b
vector unsigned short	vector unsigned char	vector unsigned char
vector unsigned int	vector unsigned short	vector unsigned short
vector unsigned long long	vector unsigned int	vector unsigned int

### **vec\_gfmsum\_128: Vector Galois Field Multiply Sum 128-bits**

d = vec\_gfmsum\_128(a, b)

Performs a Galois field multiply sum on the 2 elements of the given vectors.

Each element of a is multiplied in a Galois field with the corresponding element of b. The Galois field has an order of two. This multiplication is similar to standard binary multiplication, but instead of adding the shifted multiplicand it is exclusive ORed. The resulting 128-bits products are exclusive ORed with each other and return as a vector unsigned char.

*Table 156. Vector Galois Field Multiply Sum 128-bits*

d	a	b
vector unsigned char	vector unsigned long long	vector unsigned long long

### **vec\_gfmsum\_accum: Vector Galois Field Multiply Sum and Accumulate**

d = vec\_gfmsum\_accum(a, b, c)

Performs a Galois field multiply sum and accumulate on each element of the given vectors.

Each element of *a* is multiplied in a Galois field with the corresponding element of *b*. The Galois field has an order of two. This multiplication is similar to standard binary multiplication, but instead of adding the shifted multiplicand it is exclusive ORed. The resulting even-odd pairs of double element-sized products are exclusive ORed with each other and exclusive ORed with the corresponding double-wide element of *c*, and returned by the function.

*Table 157. Vector Galois Field Multiply Sum and Accumulate*

<b>d</b>	<b>a</b>	<b>b</b>	<b>c</b>
vector unsigned short	vector unsigned char	vector unsigned char	vector unsigned short
vector unsigned int	vector unsigned short	vector unsigned short	vector unsigned int
vector unsigned long long	vector unsigned int	vector unsigned int	vector unsigned long long

### **vec\_gfmsum\_accum\_128: Vector Galois Field Multiply Sum and Accumulate 128-bits**

`d = vec_gfmsum_accum_128(a, b, c)`

Performs a Galois field multiply sum and accumulate on the 2 elements of the given vectors.

Each element of *a* is multiplied in a Galois field with the corresponding element of *b*. The Galois field has an order of two. This multiplication is similar to standard binary multiplication, but instead of adding the shifted multiplicand it is exclusive ORed. The resulting 128-bits products are exclusive ORed with each other and exclusive ORed with the 128-bits *c*, and returned by the function.

*Table 158. Vector Galois Field Multiply Sum and Accumulate 128-bits*

<b>d</b>	<b>a</b>	<b>b</b>	<b>c</b>
vector unsigned char	vector unsigned long long	vector unsigned long long	vector unsigned char

### **vec\_madd: Vector Multiply Add**

`d = vec_madd(a, b, c)`

Returns a vector containing the results of performing a fused multiply-add operation for each corresponding set of elements of the given vectors. The value of each element of the result is the product of the values of the corresponding elements of *a* and *b*, added to the value of the corresponding element of *c*.

*Table 159. Vector Multiply Add*

<b>d</b>	<b>a</b>	<b>b</b>	<b>c</b>
vector double	vector double	vector double	vector double

### **vec\_max: Vector Maximum**

`d = vec_max(a, b)`

Returns a vector containing the maximum value from each set of corresponding elements of the given vectors. The value of each element of the result is the maximum of the values of the corresponding elements of *a* and *b*.

This function emulates the operation on vector double.



Table 160. Vector Maximum

<b>d</b>	<b>a</b>	<b>b</b>
vector signed char	vector bool char	vector signed char
	vector signed char	vector signed char
		vector bool char
vector unsigned char	vector bool char	vector unsigned char
	vector unsigned char	vector unsigned char
		vector bool char
vector signed short	vector bool short	vector signed short
	vector signed short	vector signed short
		vector bool short
vector unsigned short	vector bool short	vector unsigned short
	vector unsigned short	vector unsigned short
		vector bool short
vector signed int	vector bool int	vector signed int
	vector signed int	vector signed int
		vector bool int
vector unsigned int	vector bool int	vector unsigned int
	vector unsigned int	vector unsigned int
		vector bool int
vector signed long long	vector bool long long	vector signed long long
	vector signed long long	vector signed long long
		vector bool long long
vector unsigned long long	vector bool long long	vector unsigned long long
	vector unsigned long long	vector unsigned long long
		vector bool long long
vector double	vector double	vector double

### **vec\_meadd: Vector Multiply and Add Even**

`d = vec_meadd(a, b, c)`

Returns a vector containing a double element-sized results of performing a multiply-and-add operation for each of the even-indexed elements on the given vectors. The value of each element is the value of the double element-sized of the product of the values of the even-indexed elements of a and b, added to the value of the corresponding element of c.

Table 161. Vector Multiply and Add Even

<b>d</b>	<b>a</b>	<b>b</b>	<b>c</b>
vector unsigned short	vector unsigned char	vector unsigned char	vector unsigned short
vector signed short	vector signed char	vector signed char	vector signed short
vector unsigned int	vector unsigned short	vector unsigned short	vector unsigned int
vector signed int	vector signed short	vector signed short	vector signed int
vector unsigned long long	vector unsigned int	vector unsigned int	vector unsigned long long

Table 161. Vector Multiply and Add Even (continued)

d	a	b	c
vector signed long long	vector signed int	vector signed int	vector signed long long

### vec\_mhadd: Vector Multiply and Add High

d = vec\_mhadd(a, b, c)

Returns a vector containing the most significant ("high") half of the double element-sized results of performing a multiply-and-add operation for each corresponding set of elements of the given vectors. The value of each element of the result is the value of the most significant half of the double element-sized of the product of the values of the corresponding elements of a and b, added to the value of the corresponding element of c.

Table 162. Vector Multiply and Add High

d	a	b	c
vector unsigned char	vector unsigned char	vector unsigned char	vector unsigned char
vector signed char	vector signed char	vector signed char	vector signed char
vector unsigned short	vector unsigned short	vector unsigned short	vector unsigned short
vector signed short	vector signed short	vector signed short	vector signed short
vector unsigned int	vector unsigned int	vector unsigned int	vector unsigned int
vector signed int	vector signed int	vector signed int	vector signed int

### vec\_min: Vector Minimum

d = vec\_min(a, b)

Returns a vector containing the minimum value from each set of corresponding elements of the given vectors. The value of each element of the result is the minimum of the values of the corresponding elements of a and b.

This function emulates the operation on vector double.

Table 163. Vector Minimum

d	a	b
vector signed char	vector bool char	vector signed char
	vector signed char	vector signed char
		vector bool char
vector unsigned char	vector bool char	vector unsigned char
	vector unsigned char	vector unsigned char
		vector bool char
vector signed short	vector bool short	vector signed short
	vector signed short	vector signed short
		vector bool short
vector unsigned short	vector bool short	vector unsigned short
	vector unsigned short	vector unsigned short
		vector bool short

Table 163. Vector Minimum (continued)

d	a	b
vector signed int	vector bool int	vector signed int
	vector signed int	vector signed int
		vector bool int
vector unsigned int	vector bool int	vector unsigned int
	vector unsigned int	vector unsigned int
		vector bool int
vector signed long long	vector bool long long	vector signed long long
	vector signed long long	vector signed long long
		vector bool long long
vector unsigned long long	vector bool long long	vector unsigned long long
	vector unsigned long long	vector unsigned long long
		vector bool long long
vector double	vector double	vector double

### vec\_mladd: Vector Multiply and Add Low

`d = vec_mladd(a, b, c)`

Returns a vector containing the least significant ("low") half of the double element-sized results of performing a multiply-and-add operation for each corresponding set of elements of the given vectors. The value of each element of the result is the value of the least significant half of the double element-sized of the product of the values of the corresponding elements of a and b, added to the value of the corresponding element of c.

Table 164. Vector Multiply and Add Low

d	a	b	c
vector unsigned char	vector unsigned char	vector unsigned char	vector unsigned char
vector signed char	vector unsigned char	vector signed char	vector signed char
	vector signed char	vector unsigned char	vector unsigned char
	vector signed char	vector signed char	vector signed char
vector unsigned short	vector unsigned short	vector unsigned short	vector unsigned short
vector signed short	vector unsigned short	vector signed short	vector signed short
	vector signed short	vector unsigned short	vector unsigned short
	vector signed short	vector signed short	vector signed short
vector unsigned int	vector unsigned int	vector unsigned int	vector unsigned int
vector signed int	vector unsigned int	vector signed int	vector signed int
	vector signed int	vector unsigned int	vector unsigned int
	vector signed int	vector signed int	vector signed int

### vec\_moadd: Vector Multiply and Add Odd

`d = vec_moadd(a, b, c)`

Returns a vector containing a double element-sized results of performing a multiply-and-add operation for each of the odd-indexed elements on the given

vectors. The value of each element is the value of the double element-sized of the product of the values of the odd-indexed elements of a and b, added to the value of the corresponding element of c.

Table 165. Vector Multiply and Add Odd

d	a	b	c
vector unsigned short	vector unsigned char	vector unsigned char	vector unsigned short
vector signed short	vector signed char	vector signed char	vector signed short
vector unsigned int	vector unsigned short	vector unsigned short	vector unsigned int
vector signed int	vector signed short	vector signed short	vector signed int
vector unsigned long long	vector unsigned int	vector unsigned int	vector unsigned long long
vector signed long long	vector signed int	vector signed int	vector signed long long

### vec\_msub: Vector Multiply Subtract

$d = \text{vec\_msub}(a, b, c)$

Returns a vector containing the results of performing a multiply-subtract operation using the given vectors. This function multiplies each element in a by the corresponding element in b, and then subtracts the corresponding element in c from the result.

Table 166. Vector Multiply Subtract

d	a	b	c
vector double	vector double	vector double	vector double

### vec\_mule: Vector Multiply Even

$d = \text{vec\_mule}(a, b)$

Returns a vector containing the results of performing a multiply operation for each corresponding set of even-indexed elements of the given vectors, and extended to double element-sized of the elements.

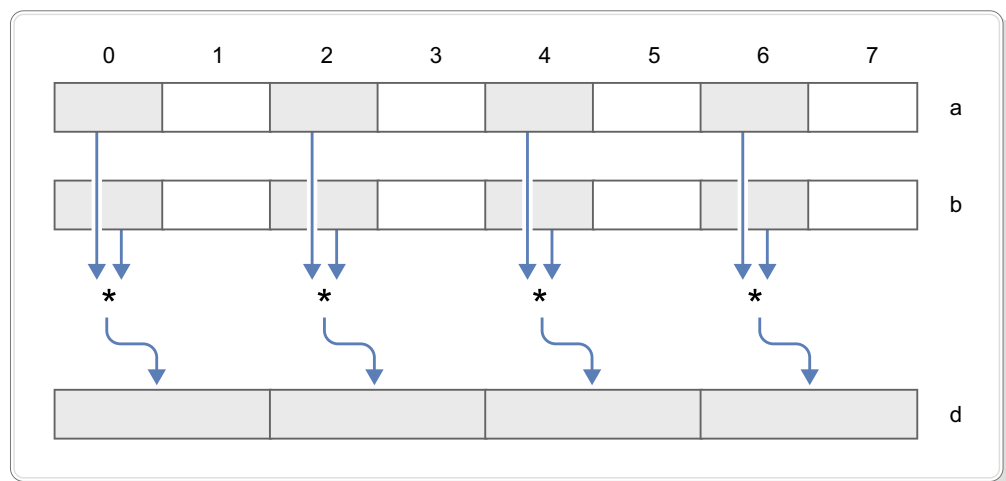

Figure 155. Even multiply of 4 integer elements (16-bit)

Table 167. Vector Multiply Even

d	a	b
vector unsigned short	vector unsigned char	vector unsigned char
vector signed short	vector signed char	vector signed char
vector unsigned int	vector unsigned short	vector unsigned short
vector signed int	vector signed short	vector signed short
vector unsigned long long	vector unsigned int	vector unsigned int
vector signed long long	vector signed int	vector signed int

### **vec\_mulh: Vector Multiply High**

`d = vec_mulh(a, b)`

Returns a vector containing the most significant ("high") half of results of performing a multiply operation using the given vectors. This function multiplies corresponding elements in the given vectors, the most significant half of the double element-sized product is assigned to the result of the corresponding elements in the result vector.

Table 168. Vector Multiply High

d	a	b
vector unsigned char	vector unsigned char	vector unsigned char
vector signed char	vector signed char	vector signed char
vector unsigned short	vector unsigned short	vector unsigned short
vector signed short	vector signed short	vector signed short
vector unsigned int	vector unsigned int	vector unsigned int
vector signed int	vector signed int	vector signed int

### **vec\_mulo: Vector Multiply Odd**

`d = vec_mulo(a, b)`

Returns a vector containing the results of performing a multiply operation for each corresponding set of odd-indexed elements of the given vectors, and extended to double element-sized of the elements.

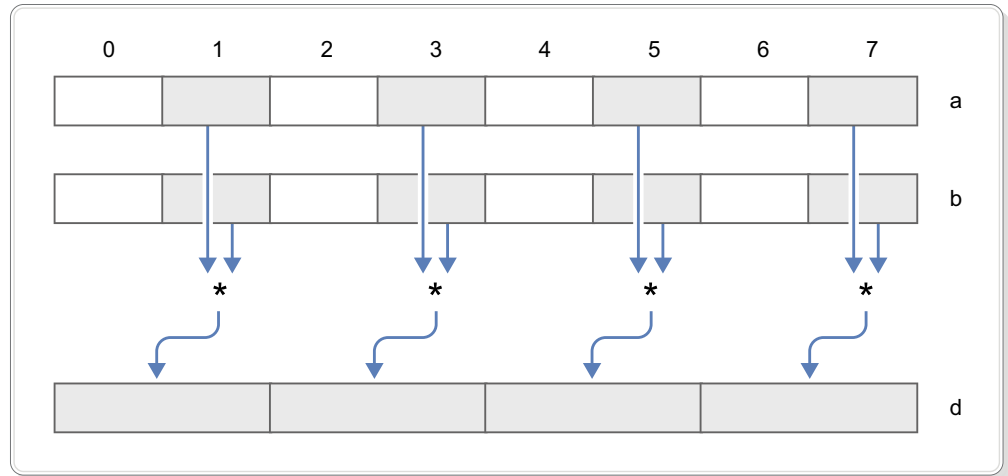

Figure 156. Odd multiply of 4 integer elements (16-bit)

Table 169. Vector Multiply Odd

d	a	b
vector unsigned short	vector unsigned char	vector unsigned char
vector signed short	vector signed char	vector signed char
vector unsigned int	vector unsigned short	vector unsigned short
vector signed int	vector signed short	vector signed short
vector unsigned long long	vector unsigned int	vector unsigned int
vector signed long long	vector signed int	vector signed int

### vec\_nabs: Vector Negative Absolute

d = vec\_nabs(a)

Returns a vector containing the results of performing a negative-absolute operation using the given vector. This function computes the absolute value of each element in the given vector and then assigns the negated value of the result to the corresponding elements in the result vector.

**Note:** This built-in function will not cause IEEE exception.

Table 170. Vector Negative Absolute

d	a
vector double	vector double

### vec\_sqrt: Vector Square Root

d = vec\_sqrt(a)

Returns a vector containing the square root of each element in the given vector.

Table 171. Vector Square Root

d	a
vector double	vector double

## **vec\_sub\_u128: Vector Subtract unsigned 128-bits**

`d = vec_sub_u128(a, b)`

Subtracts unsigned quadword values.

This function operates on the vectors as 128-bit unsigned integers. It returns low 128 bits of  $a - b$ .

*Table 172. Vector Subtract unsigned 128-bits*

<b>d</b>	<b>a</b>	<b>b</b>
vector unsigned char	vector unsigned char	vector unsigned char

## **vec\_subc: Vector Subtract Carryout**

`d = vec_subc(a, b)`

Returns a vector containing the borrow produced by subtracting each of corresponding elements of  $b$  from  $a$ .

On each resulting element, the value is 0 if a borrow occurred, or 1 if no borrow occurred.

*Table 173. Vector Subtract Carryout*

<b>d</b>	<b>a</b>	<b>b</b>
vector unsigned char	vector unsigned char	vector unsigned char
vector unsigned short	vector unsigned short	vector unsigned short
vector unsigned int	vector unsigned int	vector unsigned int
vector unsigned long long	vector unsigned long long	vector unsigned long long

## **vec\_subc\_u128: Vector Subtract Carryout unsigned 128-bits**

`d = vec_subc_u128(a, b)`

Gets the carry bit of the 128-bit subtraction of two quadword values.

This function operates on the vectors as 128-bit unsigned integers. It returns a vector containing the borrow produced by subtracting  $b$  from  $a$ , as unsigned 128-bits integers.

If no borrow occurred, the 127-bit of  $d$  is 1, otherwise 0. All other bits of  $d$  are 0.

*Table 174. Vector Subtract Carryout unsigned 128-bits*

<b>d</b>	<b>a</b>	<b>b</b>
vector unsigned char	vector unsigned char	vector unsigned char

## **vec\_sube\_u128: Vector Subtract with Carryout**

`d = vec_sube_u128(a, b, c)`

Subtracts unsigned quadword values with carry bit from a previous operation.

This function operates on the vectors as 128-bit unsigned integers. It returns a vector containing the result of subtracting of  $b$  from  $a$ , and the carryout bit from a previous operation.

**Note:** Only the borrow indication bit (127-bit) of c is used, and the other bits are ignored.

*Table 175. Vector Subtract with Carryout*

d	a	b	c
vector unsigned char	vector unsigned char	vector unsigned char	vector unsigned char

### **vec\_subec\_u128: Vector Subtract with Carryout, Carryout**

$d = \text{vec\_subec\_u128}(a, b, c)$

Gets the carry bit of the 128-bit subtraction of two quadword values with carry bit from the previous operation.

It returns a vector containing the carryout produced from the result of subtracting of b from a, and the carryout bit from a previous operation. If no borrow occurred, the 127-bit of d is 1, otherwise 0. All other bits of d are 0.

**Note:** Only the borrow indication bit (127-bit) of c is used, and the other bits are ignored.

*Table 176. Vector Subtract with Carryout, Carryout*

d	a	b	c
vector unsigned char	vector unsigned char	vector unsigned char	vector unsigned char

### **vec\_sum\_u128: Vector Sum Across Quadword**

$d = \text{vec\_sum\_u128}(a, b)$

Returns a vector containing the results of performing a sum across all the elements in each of the quadword of vector a, and the rightmost word or doubleword element of the b. The result is an unsigned 128-bit integer. The result vector is obtained as follow:

For vector unsigned int operands:

$d = a[0] + a[1] + a[2] + a[3] + b[3]$

For vector unsigned long long operands:

$d = a[0] + a[1] + b[1]$

*Table 177. Vector Sum Across Quadword*

d	a	b
vector unsigned char	vector unsigned int	vector unsigned int
	vector unsigned long long	vector unsigned long long

### **vec\_sum2: Vector Sum Across Doubleword**

$d = \text{vec\_sum2}(a, b)$

Returns a vector containing the results of performing a sum across all the elements in each of the doubleword of vector a, and the rightmost sub-element of the corresponding doubleword of b.



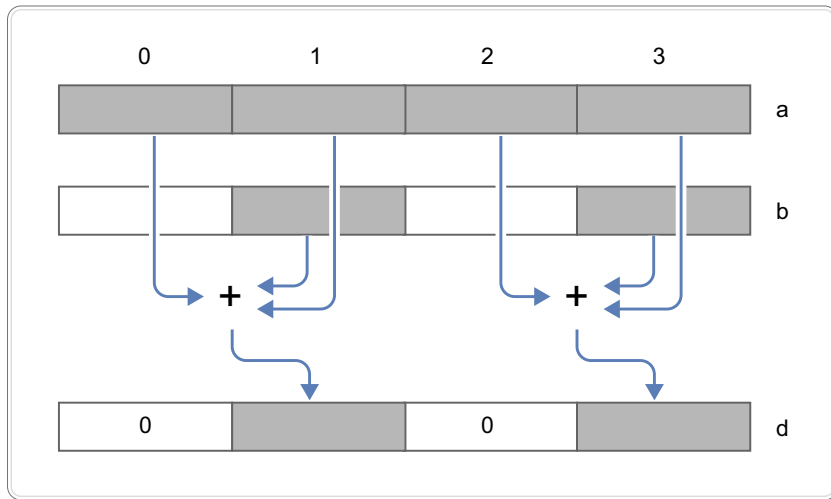

Figure 157. Two sums in the 4 unsigned integer elements (32-bit)

The result vector is obtained as follows:

For vector unsigned short operands:

$$d[0] = a[0] + a[1] + a[2] + a[3] + b[3]$$

$$d[1] = a[4] + a[5] + a[6] + a[7] + b[7]$$

For vector unsigned int operands:

$$d[0] = a[0] + a[1] + b[1]$$

$$d[1] = a[2] + a[3] + b[3]$$

Table 178. Vector Sum Across Doubleword

d	a	b
vector unsigned long long	vector unsigned short	vector unsigned short
	vector unsigned int	vector unsigned int

### vec\_sum4: Vector Sum Across Word

`d = vec_sum4(a, b)`

Returns a vector containing the results of performing a sum across all the elements in each of the word of vector `a`, and the rightmost sub-element of the corresponding word of `a`. The result vector is obtained as follow:

For vector unsigned char operands:

$$d[0] = a[0] + a[1] + a[2] + a[3] + b[3]$$

$$d[1] = a[4] + a[5] + a[6] + a[7] + b[7]$$

$$d[2] = a[8] + a[8] + a[10] + a[11] + b[11]$$

$$d[3] = a[12] + a[13] + a[14] + a[15] + b[15]$$

For vector unsigned short operands:

$$d[0] = a[0] + a[1] + b[1]$$

$$d[1] = a[2] + a[3] + b[3]$$

$$d[2] = a[4] + a[5] + b[5]$$

$$d[3] = a[6] + a[7] + b[7]$$

Table 179. Vector Sum Across Word

d	a	b
vector unsigned int	vector unsigned char	vector unsigned char
	vector unsigned short	vector unsigned short

## Compare

This section describes vector built-in functions for comparing elements.

### vec\_cmpeq: Vector Compare Equal

`d = vec_cmpeq(a, b)`

Returns a vector containing the results of comparing each set of corresponding elements of the given vectors for equality. For each element of the result, the value of each bit is 1 if the corresponding elements of a and b are equal. Otherwise, the value of each bit is 0.

Table 180. Vector Compare Equal

d	a	b
vector bool char	vector bool char	vector bool char
	vector signed char	vector signed char
	vector unsigned char	vector unsigned char
vector bool short	vector bool short	vector bool short
	vector signed short	vector signed short
	vector unsigned short	vector unsigned short
vector bool int	vector bool int	vector bool int
	vector signed int	vector signed int
	vector unsigned int	vector unsigned int
vector bool long long	vector bool long long	vector bool long long
	vector signed long long	vector signed long long
	vector unsigned long long	vector unsigned long long
	vector double	vector double

### vec\_cmpeq\_idx: Vector Compare Equal Index

`d = vec_cmpeq_idx(a, b)`

Returns the lowest byte-index of comparing each set of corresponding elements of the given vectors for equality. If the two vectors are not equal, the result is 16.

The result is placed into byte element seven of the returned vector, and all other bytes are set to 0.

Table 181. Vector Compare Equal Index

d	a	b
vector signed char	vector signed char	vector signed char
vector unsigned char	vector bool char	vector bool char
	vector unsigned char	vector unsigned char
vector signed short	vector signed short	vector signed short

Table 181. Vector Compare Equal Index (continued)

d	a	b
vector unsigned short	vector bool short	vector bool short
	vector unsigned short	vector unsigned short
vector signed int	vector signed int	vector signed int
vector unsigned int	vector bool int	vector bool int
	vector unsigned int	vector unsigned int

### vec\_cmpeq\_idx\_cc: Vector Compare Equal Index with Condition Code

d = vec\_cmpeq\_idx\_cc(a, b, c)

Returns the lowest byte-index of comparing each set of corresponding elements of the given vectors for equality. If the two vectors are not equal, the result is 16. c is set to 1, if there is any elements of a equals the corresponding element of b, otherwise c is set to 3.

The result is placed into byte element seven of the returned vector, and all other bytes are set to 0.

Table 182. Vector Compare Equal Index with Condition Code

d	a	b	c
vector signed char	vector signed char	vector signed char	int *
vector unsigned char	vector bool char	vector bool char	
	vector unsigned char	vector unsigned char	
vector signed short	vector signed short	vector signed short	
vector unsigned short	vector bool short	vector bool short	
	vector unsigned short	vector unsigned short	
vector signed int	vector signed int	vector signed int	
vector unsigned int	vector bool int	vector bool int	
	vector unsigned int	vector unsigned int	

### vec\_cmpeq\_or\_0\_idx: Vector Compare Equal or Zero Index

d = vec\_cmpeq\_or\_0\_idx(a, b)

Returns the lowest byte-index of comparing each set of corresponding elements of the given vectors for equality, and comparing each elements of a against 0. If the two vectors are not equal, and no elements of a is 0, the result is 16.

The result is placed into byte element seven of the returned vector, and all other bytes are set to 0.

Table 183. Vector Compare Equal or Zero Index

d	a	b
vector signed char	vector signed char	vector signed char
vector unsigned char	vector bool char	vector bool char
	vector unsigned char	vector unsigned char
vector signed short	vector signed short	vector signed short

Table 183. Vector Compare Equal or Zero Index (continued)

d	a	b
vector unsigned short	vector bool short	vector bool short
	vector unsigned short	vector unsigned short
vector signed int	vector signed int	vector signed int
vector unsigned int	vector bool int	vector bool int
	vector unsigned int	vector unsigned int

### **vec\_cmpeq\_or\_0\_idx\_cc: Vector Compare Equal or Zero Index with Condition Code**

`d = vec_cmpeq_or_0_idx_cc(a, b, c)`

Returns the lowest byte-index of comparing each set of corresponding elements of the given vectors for equality, and comparing each elements of a against 0. If the two vectors are not equal, and no elements of a is 0, the result is 16.

c would be set to one of the following values:

- 0 - if no elements of the 2 vectors are equal, and at least one element from a with a value of 0.
- 1 - if at least one element of a equals the corresponding element of b, and no elements of a has a value of 0.
- 2 - if at least one element of a equals the corresponding element of b with an equal value, and there is at least one element from a has a value of 0.
- 3 - if no element of a equals the corresponding element of b, and there is no element from a with a value of 0.

The result is placed into byte element seven of the returned vector, and all other bytes are set to 0.

Table 184. Vector Compare Equal or Zero Index with Condition Code

d	a	b	c
vector signed char	vector signed char	vector signed char	int *
vector unsigned char	vector bool char	vector bool char	
	vector unsigned char	vector unsigned char	
vector signed short	vector signed short	vector signed short	
vector unsigned short	vector bool short	vector bool short	
	vector unsigned short	vector unsigned short	
vector signed int	vector signed int	vector signed int	
vector unsigned int	vector bool int	vector bool int	
	vector unsigned int	vector unsigned int	

### **vec\_cmpge: Vector Compare Greater Than or Equal**

`d = vec_cmpge(a, b)`

Returns a vector containing the results of a greater-than-or-equal-to comparison between each set of corresponding elements of the given vectors. For each element

of the result, the value of each bit is 1 if the value of the corresponding element of a is greater than or equal to the value of the corresponding element of b. Otherwise, the value of each bit is 0.

This function emulates the operation on the integer vectors.

*Table 185. Vector Compare Greater Than or Equal*

<b>d</b>	<b>a</b>	<b>b</b>
vector bool char	vector signed char	vector signed char
	vector unsigned char	vector unsigned char
vector bool short	vector signed short	vector signed short
	vector unsigned short	vector unsigned short
vector bool int	vector signed int	vector signed int
	vector unsigned int	vector unsigned int
vector bool long long	vector signed long long	vector signed long long
	vector unsigned long long	vector unsigned long long
	vector double	vector double

### **vec\_cmpgt: Vector Compare Greater Than**

`d = vec_cmpgt(a, b)`

Returns a vector containing the results of a greater-than comparison between each set of corresponding elements of the given vectors. For each element of the result, the value of each bit is 1 if the value of the corresponding element of a is greater than the value of the corresponding element of b. Otherwise, the value of each bit is 0.

*Table 186. Vector Compare Greater Than*

<b>d</b>	<b>a</b>	<b>b</b>
vector bool char	vector signed char	vector signed char
	vector unsigned char	vector unsigned char
vector bool short	vector signed short	vector signed short
	vector unsigned short	vector unsigned short
vector bool int	vector signed int	vector signed int
	vector unsigned int	vector unsigned int
vector bool long long	vector signed long long	vector signed long long
	vector unsigned long long	vector unsigned long long
	vector double	vector double

### **vec\_cmple: Vector Compare Less Than or Equal**

`d = vec_cmple(a, b)`

Returns a vector containing the results of a less-than-or-equal-to comparison between each set of corresponding elements of the given vectors. For each element of the result, the value of each bit is 1 if the value of the corresponding element of a is less than or equal to the value of the corresponding element of b. Otherwise, the value of each bit is 0.

Table 187. Vector Compare Less Than or Equal

<b>d</b>	<b>a</b>	<b>b</b>
vector bool char	vector signed char	vector signed char
	vector unsigned char	vector unsigned char
vector bool short	vector signed short	vector signed short
	vector unsigned short	vector unsigned short
vector bool int	vector signed int	vector signed int
	vector unsigned int	vector unsigned int
vector bool long long	vector signed long long	vector signed long long
	vector unsigned long long	vector unsigned long long
	vector double	vector double

### **vec\_cmplt: Vector Compare Less Than**

`d = vec_cmplt(a, b)`

Returns a vector containing the results of a less-than comparison between each set of corresponding elements of the given vectors. For each element of the result, the value of each bit is 1 if the value of the corresponding element of a is less than the value of the corresponding element of b. Otherwise, the value of each bit is 0.

This operation emulates the operation on the integer vectors.

Table 188. Vector Compare Less Than

<b>d</b>	<b>a</b>	<b>b</b>
vector bool char	vector signed char	vector signed char
	vector unsigned char	vector unsigned char
vector bool short	vector signed short	vector signed short
	vector unsigned short	vector unsigned short
vector bool int	vector signed int	vector signed int
	vector unsigned int	vector unsigned int
vector bool long long	vector signed long long	vector signed long long
	vector unsigned long long	vector unsigned long long
	vector double	vector double

### **vec\_cmpne\_idx: Vector Compare Not Equal Index**

`d = vec_cmpne_idx(a, b)`

Returns the lowest byte-index of comparing each set of corresponding elements of the given vectors for inequality. If the two vectors are equal, the result is 16.

The result is placed into byte element seven of the returned vector, all other bytes are set to 0.

Table 189. Vector Compare Not Equal Index

<b>d</b>	<b>a</b>	<b>b</b>
vector signed char	vector signed char	vector signed char

Table 189. Vector Compare Not Equal Index (continued)

d	a	b
vector unsigned char	vector bool char	vector bool char
	vector unsigned char	vector unsigned char
vector signed short	vector signed short	vector signed short
vector unsigned short	vector bool short	vector bool short
	vector unsigned short	vector unsigned short
vector signed int	vector signed int	vector signed int
vector unsigned int	vector bool int	vector bool int
	vector unsigned int	vector unsigned int

### **vec\_cmpne\_idx\_cc: Vector Compare Not Equal Index with Condition Code**

`d = vec_cmpne_idx_cc(a, b, c)`

Returns the lowest byte-index of comparing each set of corresponding elements of the given vectors for inequality. If the two vectors are equal, the result is 16.

`c` is set to the following value:

- 1 - if there is a mismatch and that first element from the 0-index of `a` is less than the corresponding element of `b`.
- 2 - if there is a mismatch and that element from the 0-index of `a` is greater than the corresponding element of `b`.
- 3 - if the two vectors are equal.

The result is placed into byte element seven of the returned vector, and all other bytes are set to 0.

Table 190. Vector Compare Not Equal Index with Condition Code

d	a	b	c
vector signed char	vector signed char	vector signed char	int *
vector unsigned char	vector bool char	vector bool char	
	vector unsigned char	vector unsigned char	
vector signed short	vector signed short	vector signed short	
vector unsigned short	vector bool short	vector bool short	
	vector unsigned short	vector unsigned short	
vector signed int	vector signed int	vector signed int	
vector unsigned int	vector bool int	vector bool int	
	vector unsigned int	vector unsigned int	

### **vec\_cmpne\_or\_0\_idx: Vector Compare Not Equal or Zero Index**

`d = vec_cmpne_or_0_idx(a, b)`

Returns the lowest byte-index of comparing each set of corresponding elements of the given vectors for inequality, and comparing each elements of `a` against 0. If the two vectors are equal, and no elements of `a` is 0, the result is 16.

The result is placed into byte element seven of the returned vector, and all other bytes are set to 0.

*Table 191. Vector Compare Not Equal or Zero Index*

<b>d</b>	<b>a</b>	<b>b</b>
vector signed char	vector signed char	vector signed char
vector unsigned char	vector bool char	vector bool char
	vector unsigned char	vector unsigned char
vector signed short	vector signed short	vector signed short
vector unsigned short	vector bool short	vector bool short
	vector unsigned short	vector unsigned short
vector signed int	vector signed int	vector signed int
vector unsigned int	vector bool int	vector bool int
	vector unsigned int	vector unsigned int

### **vec\_cmpne\_or\_0\_idx\_cc: Vector Compare Not Equal or Zero Index with Condition Code**

`d = vec_cmpne_or_0_idx_cc(a, b, c)`

Returns the lowest byte-index of comparing each set of corresponding elements of the given vectors for inequality, and comparing each elements of a against 0. If the two vectors are equal, and no elements of a is 0, the result is 16.

c is set to the following value:

- 0 - if zero is found on an element of a, starting from the 0-index, before there is a mismatch between the corresponding elements of a and b.
- 1 - if there is a mismatch, and that first element, from the 0-index, of a is less than the corresponding element of b, and prior to the mismatch a is not 0.
- 2 - if there is a mismatch, and that element, from the 0-index, of a is greater than the corresponding element of b, and prior to the mismatch a is not 0.
- 3 - if the two vectors are equal, and there is no element from a with a value of 0.

The result is placed into byte element seven of the returned vector, and all other bytes are set to 0.

*Table 192. Vector Compare Not Equal or Zero Index with Condition Code*

<b>d</b>	<b>a</b>	<b>b</b>	<b>c</b>
vector signed char	vector signed char	vector signed char	int *
vector unsigned char	vector bool char	vector bool char	
	vector unsigned char	vector unsigned char	
vector signed short	vector signed short	vector signed short	
vector unsigned short	vector bool short	vector bool short	
	vector unsigned short	vector unsigned short	
vector signed int	vector signed int	vector signed int	
vector unsigned int	vector bool int	vector bool int	
	vector unsigned int	vector unsigned int	



## Compare Ranges

This section describes vector built-in functions for comparing ranges.

### **vec\_cmpnrg: Vector Compare Not in Ranges**

`d = vec_cmpnrg(a, b, c)`

Check if each element of `a` is not within any of the ranges specified by `b` and `c`. Each even-odd element pairs of `b` define values for the limits of the ranges. The corresponding even-odd pairs of elements in `c` control how the comparison to be performed, in the following way:

Comparison	for vector unsigned char	for vector unsigned short	for vector unsigned int
ignore - result of comparison always TRUE	0	0	0
equal	0x80	0x8000	0x80000000
not equal	0x60	0x6000	0x60000000
greater than	0x20	0x2000	0x20000000
greater than or equal	0xA0	0xA000	0xA0000000
less than	0x40	0x4000	0x40000000
less than and equal	0xC0	0xC000	0xC0000000
force to FALSE	0xE0	0xE000	0xE0000000

For each element of the result, the value of each bit is 1 if the corresponding element of `a` was not contained in any of the specified ranges. Otherwise, the value of each bit is 0.

*Table 193. Vector Compare Not in Ranges*

<b>d</b>	<b>a</b>	<b>b</b>	<b>c</b>
vector bool char	vector unsigned char	vector unsigned char	vector unsigned char
vector bool short	vector unsigned short	vector unsigned short	vector unsigned short
vector bool int	vector unsigned int	vector unsigned int	vector unsigned int

#### Example 1: Comparing 2 ranges

```
vector unsigned int a = {11, 22, 33, 44};
vector unsigned int b = {10, 20, 30, 40};
vector unsigned int c = {0x20000000, 0x40000000, 0x20000000,
                        0x40000000}; // {GT, LT, GT, LT}
```

```
vector bool int d = vec_cmpnrg(a, b, c);
// d = {0, 0xFFFFFFFF, 0, 0xFFFFFFFF}
```

In this example, each element of `a` is checked to be (> 10 AND < 20) OR (> 30 AND < 40).

#### Example 2: Comparing a single range, and a specific value

```
vector unsigned int a = {11, 22, 33, 30};
vector unsigned int b = {10, 20, 30, 30};
vector unsigned int c = {0x20000000, 0x40000000, 0x80000000,
```

```

                                0x80000000}); // {GT, LT, EQ, EQ}

vector<bool> d = vec_cmpnrg(a, b, c);
// d = {0, 0xFFFFFFFF, 0xFFFFFFFF, 0}

```

In this example, each element of a is checked to be (> 10 AND < 20) OR equals to 30.

Example 3: Comparing a single range

```

vector<unsigned int> a = {11, 22, 33, 44};
vector<unsigned int> b = {10, 20, 30, 40};
vector<unsigned int> c = {0x20000000, 0x40000000, 0x00000000,
                        0x00000000}; // {GT, LT, X, X}

```

```

vector<bool> d = vec_cmpnrg(a, b, c);
// d = {0, 0xFFFFFFFF, 0xFFFFFFFF, 0xFFFFFFFF}

```

In this example, each element of a is checked to be (> 10 AND < 20) only.

### **vec\_cmpnrg\_cc: Vector Compare Not in Ranges with Condition Code**

```
e = vec_cmpnrg_cc(a, b, c, d)
```

Check if each element of a is not within any of the ranges specified by b and c. Each even-odd element pairs of b define values for the limits of the ranges. The corresponding even-odd pairs of elements in c control how the comparison to be performed, in the following way:

Comparison	for vector unsigned char	for vector unsigned short	for vector unsigned int
ignore - result of comparison always TRUE	0	0	0
equal	0x80	0x8000	0x80000000
not equal	0x60	0x6000	0x60000000
greater than	0x20	0x2000	0x20000000
greater than or equal	0xA0	0xA000	0xA0000000
less than	0x40	0x4000	0x40000000
less than and equal	0xC0	0xC000	0xC0000000
force to FALSE	0xE0	0xE000	0xE0000000

For each element of the result, the value of each bit is 1 if the corresponding element of a was not contained in any of the specified ranges. Otherwise, the value of each bit is 0.

d is set to 1, if there is at least one element of a is found not within any of the ranges. Otherwise, d is set to 3.

Table 194. Vector Compare Not in Ranges with Condition Code

e	a	b	c	d
vector bool char	vector unsigned char	vector unsigned char	vector unsigned char	int *
vector bool short	vector unsigned short	vector unsigned short	vector unsigned short	
vector bool int	vector unsigned int	vector unsigned int	vector unsigned int	

### vec\_cmpnrg\_idx: Vector Compare Not in Ranges Index

d = vec\_cmpnrg\_idx(a, b, c)

Returns the lowest byte-index of the element of a that is not within any of the ranges specified by b and c. Each even-odd element pairs of b define values for the limits of the ranges. The corresponding even-odd pairs of elements in c control how the comparison to be performed, in the following way:

Comparison	for vector unsigned char	for vector unsigned short	for vector unsigned int
ignore - result of comparison always TRUE	0	0	0
equal	0x80	0x8000	0x80000000
not equal	0x60	0x6000	0x60000000
greater than	0x20	0x2000	0x20000000
greater than or equal	0xA0	0xA000	0xA0000000
less than	0x40	0x4000	0x40000000
less than and equal	0xC0	0xC000	0xC0000000
force to FALSE	0xE0	0xE000	0xE0000000

The result is the lowest byte-index from element of a that is not contained in any of the specified ranges. Otherwise, the result is 16.

The result is placed into byte element seven of the returned vector, and all other bytes are set to 0.

Table 195. Vector Compare Not in Ranges Index

d	a	b	c
vector unsigned char	vector unsigned char	vector unsigned char	vector unsigned char
vector unsigned short	vector unsigned short	vector unsigned short	vector unsigned short
vector unsigned int	vector unsigned int	vector unsigned int	vector unsigned int

Example:

```
vector unsigned int a = {1, 11, 22, 33};
vector unsigned int b = {10, 20, 30, 40};
vector unsigned int c = {0x20000000, 0x40000000, 0x20000000,
                        0x40000000}; // {GT, LT, GT, LT}
```

```
vector unsigned int d = vec_cmpnrg_idx(a, b, c); // byte 7 of d = 0
```

In this example, each element of a is tested to be NOT((> 10 AND < 20) OR (>30 AND < 40)), the first element (byte index 0) is the first element satisfying the condition.

### **vec\_cmpnrg\_idx\_cc: Vector Compare Not in Ranges Index with Condition Code**

`e = vec_cmpnrg_idx_cc(a, b, c, d)`

Returns the lowest byte-index of the element of a that is not within any of the ranges specified by b and c. Each even-odd element pairs of b define values for the limits of the ranges. The corresponding even-odd pairs of elements in c control how the comparison to be performed, in the following way:

Comparison	for vector unsigned char	for vector unsigned short	for vector unsigned int
ignore - result of comparison always TRUE	0	0	0
equal	0x80	0x8000	0x80000000
not equal	0x60	0x6000	0x60000000
greater than	0x20	0x2000	0x20000000
greater than or equal	0xA0	0xA000	0xA0000000
less than	0x40	0x4000	0x40000000
less than and equal	0xC0	0xC000	0xC0000000
force to FALSE	0xE0	0xE000	0xE0000000

d is set to 1, if there is at least one element of a is found not within any of the ranges. Otherwise, d is set to 3.

The result is placed into byte element seven of the returned vector, and all other bytes are set to 0.

*Table 196. Vector Compare Not in Ranges Index with Condition Code*

e	a	b	c	d
vector unsigned char	vector unsigned char	vector unsigned char	vector unsigned char	int *
vector unsigned short	vector unsigned short	vector unsigned short	vector unsigned short	
vector unsigned int	vector unsigned int	vector unsigned int	vector unsigned int	

### **vec\_cmpnrg\_or\_0\_idx: Vector Compare Not in Ranges or Zero Index**

`d = vec_cmpnrg_or_0_idx(a, b, c)`

Returns the lowest byte-index of the element of a that is 0 or not within any of the ranges specified by b and c. Each even-odd element pairs of b define values for the limits of the ranges. The corresponding even-odd pairs of elements in c control how the comparison to be performed, in the following way:

Comparison	for vector unsigned char	for vector unsigned short	for vector unsigned int
ignore - result of comparison always TRUE	0	0	0
equal	0x80	0x8000	0x80000000
not equal	0x60	0x6000	0x60000000
greater than	0x20	0x2000	0x20000000
greater than or equal	0xA0	0xA000	0xA0000000
less than	0x40	0x4000	0x40000000
less than and equal	0xC0	0xC000	0xC0000000
force to FALSE	0xE0	0xE000	0xE0000000

The result is the lowest byte-index from element of a that is 0 or not contained in any of the specified ranges. Otherwise, the result is 16.

The result is placed into byte element seven of the returned vector, and all other bytes are set to 0.

Table 197. Vector Compare Not in Ranges or Zero Index

d	a	b	c
vector unsigned char	vector unsigned char	vector unsigned char	vector unsigned char
vector unsigned short	vector unsigned short	vector unsigned short	vector unsigned short
vector unsigned int	vector unsigned int	vector unsigned int	vector unsigned int

Example:

```
vector unsigned int a = {11, 33, 0, 22};
vector unsigned int b = {10, 20, 30, 40};
vector unsigned int c = {0x20000000, 0x40000000, 0x20000000,
                        0x40000000}; // {GT, LT, GT, LT}
```

```
vector unsigned int d = vec_cmpnrg_or_0_idx(a, b, c); // byte 7 of d = 8
```

In this example, each element of a is tested to be (equals 0) OR NOT((> 10 AND < 20) OR (>30 AND < 40)), the third element (byte index 8) is the first element satisfying the condition.

### **vec\_cmpnrg\_or\_0\_idx\_cc: Vector Compare Not in Ranges or Zero Index with Condition Code**

```
e = vec_cmpnrg_or_0_idx_cc(a, b, c, d)
```

Returns the lowest byte-index of the element of a that is 0 or not within any of the ranges specified by b and c. Each even-odd element pairs of b define values for the limits of the ranges. The corresponding even-odd pairs of elements in c control how the comparison to be performed, in the following way:

Comparison	for vector unsigned char	for vector unsigned short	for vector unsigned int
ignore - result of comparison always TRUE	0	0	0
equal	0x80	0x8000	0x80000000
not equal	0x60	0x6000	0x60000000
greater than	0x20	0x2000	0x20000000
greater than or equal	0xA0	0xA000	0xA0000000
less than	0x40	0x4000	0x40000000
less than and equal	0xC0	0xC000	0xC0000000
force to FALSE	0xE0	0xE000	0xE0000000

d is set to one of the following:

- 0 - if 0 was found on an element of a, before an element was not found within the specified range.
- 1 - if no element of a is 0, and there is at least one element of a found not in any of the ranges.
- 2 - if 0 was found on an element of a after an element was found not within the specified range.
- 3 - no element is 0 and found to be not within any of the specified range.

The result is placed into byte element seven of the returned vector, and all other bytes are set to 0.

Table 198. Vector Compare Not in Ranges or Zero Index with Condition Code

e	a	b	c	d
vector unsigned char	vector unsigned char	vector unsigned char	vector unsigned char	int *
vector unsigned short	vector unsigned short	vector unsigned short	vector unsigned short	
vector unsigned int	vector unsigned int	vector unsigned int	vector unsigned int	

## vec\_cmprg: Vector Compare Ranges

d = vec\_cmprg(a, b, c)

Check if each element of a is within any of the ranges specified by b and c. Each even-odd element pairs of b define values for the limits of the ranges. The corresponding even-odd pairs of elements in c control how the comparison to be performed, in the following way:

Comparison	for vector unsigned char	for vector unsigned short	for vector unsigned int
ignore - result of comparison always TRUE	0	0	0
equal	0x80	0x8000	0x80000000
not equal	0x60	0x6000	0x60000000

Comparison	for vector unsigned char	for vector unsigned short	for vector unsigned int
greater than	0x20	0x2000	0x20000000
greater than or equal	0xA0	0xA000	0xA0000000
less than	0x40	0x4000	0x40000000
less than and equal	0xC0	0xC000	0xC0000000
force to FALSE	0xE0	0xE000	0xE0000000

For each element of the result, the value of each bit is 1 if the corresponding element of a was contained in any of the specified ranges. Otherwise, the value of each bit is 0.

Table 199. Vector Compare Ranges

d	a	b	c
vector bool char	vector unsigned char	vector unsigned char	vector unsigned char
vector bool short	vector unsigned short	vector unsigned short	vector unsigned short
vector bool int	vector unsigned int	vector unsigned int	vector unsigned int

#### Example 1: Comparing 2 ranges

```
vector unsigned int a = {11, 22, 33, 44};
vector unsigned int b = {10, 20, 30, 40};
vector unsigned int c = {0x20000000, 0x40000000, 0x20000000,
                        0x40000000}; // {GT, LT, GT, LT}

vector bool int d = vec_cmprg(a, b, c);
// d = {0xFFFFFFFF, 0, 0xFFFFFFFF, 0}
```

In this example, each element of a is checked to be (> 10 AND < 20) OR (> 30 AND < 40).

#### Example 2: Comparing a single range, and a specific value

```
vector unsigned int a = {11, 22, 33, 30};
vector unsigned int b = {10, 20, 30, 30};
vector unsigned int c = {0x20000000, 0x40000000, 0x80000000,
                        0x80000000}; // {GT, LT, EQ, EQ}

vector bool int d = vec_cmprg(a, b, c);
// d = {0xFFFFFFFF, 0, 0, 0xFFFFFFFF}
```

In this example, each element of a is checked to be (> 10 AND < 20) OR equals to 30.

#### Example 3: Comparing a single range

```
vector unsigned int a = {11, 22, 33, 44};
vector unsigned int b = {10, 20, 30, 40};
vector unsigned int c = {0x20000000, 0x40000000, 0x00000000,
                        0x00000000}; // {GT, LT, X, X}

vector bool int d = vec_cmprg(a, b, c);
// d = {0xFFFFFFFF, 0, 0, 0}
```

In this example, each element of a is checked to be (> 10 AND < 20) only.

## vec\_cmprg\_cc: Vector Compare Ranges with Condition Code

e = vec\_cmprg\_cc(a, b, c, d)

Check if each element of a is within any of the ranges specified by b and c. Each even-odd element pairs of b define values for the limits of the ranges. The corresponding even-odd pairs of elements in c control how the comparison to be performed, in the following way:

Comparison	for vector unsigned char	for vector unsigned short	for vector unsigned int
ignore - result of comparison always TRUE	0	0	0
equal	0x80	0x8000	0x80000000
not equal	0x60	0x6000	0x60000000
greater than	0x20	0x2000	0x20000000
greater than or equal	0xA0	0xA000	0xA0000000
less than	0x40	0x4000	0x40000000
less than and equal	0xC0	0xC000	0xC0000000
force to FALSE	0xE0	0xE000	0xE0000000

For each element of the result, the value of each bit is 1 if the corresponding element of a was contained in any of the specified ranges. Otherwise, the value of each bit is 0.

d is set to 1, if there is at least one element of a found in any of the ranges. Otherwise, d is set to 3.

Table 200. Vector Compare Ranges with Condition Code

e	a	b	c	d
vector bool char	vector unsigned char	vector unsigned char	vector unsigned char	int *
vector bool short	vector unsigned short	vector unsigned short	vector unsigned short	
vector bool int	vector unsigned int	vector unsigned int	vector unsigned int	

## vec\_cmprg\_idx: Vector Compare Ranges Index

d = vec\_cmprg\_idx(a, b, c)

Returns the lowest byte-index of the element of a that is within any of the ranges specified by b and c. Each even-odd element pairs of b define values for the limits of the ranges. The corresponding even-odd pairs of elements in c control how the comparison to be performed, in the following way:

Comparison	for vector unsigned char	for vector unsigned short	for vector unsigned int
ignore - result of comparison always TRUE	0	0	0
equal	0x80	0x8000	0x80000000



Comparison	for vector unsigned char	for vector unsigned short	for vector unsigned int
not equal	0x60	0x6000	0x60000000
greater than	0x20	0x2000	0x20000000
greater than or equal	0xA0	0xA000	0xA0000000
less than	0x40	0x4000	0x40000000
less than and equal	0xC0	0xC000	0xC0000000
force to FALSE	0xE0	0xE000	0xE0000000

The result is the lowest byte-index from element of a that is contained in any of the specified ranges. Otherwise, the result is 16.

The result is placed into byte element seven of the returned vector, and all other bytes are set to 0.

Table 201. Vector Compare Ranges Index

d	a	b	c
vector unsigned char	vector unsigned char	vector unsigned char	vector unsigned char
vector unsigned short	vector unsigned short	vector unsigned short	vector unsigned short
vector unsigned int	vector unsigned int	vector unsigned int	vector unsigned int

Example:

```
vector unsigned int a = {1, 11, 22, 33};
vector unsigned int b = {10, 20, 30, 40};
vector unsigned int c = {0x20000000, 0x40000000, 0x20000000,
                        0x40000000}; // {GT, LT, GT, LT}
```

```
vector unsigned int d = vec_cmprg_idx(a, b, c); // byte 7 of d = 4
```

In this example, each element of a is tested to be ((> 10 AND < 20) OR (>30 AND < 40)), the second element (byte index 4) is the first element satisfying the condition.

### vec\_cmprg\_idx\_cc: Vector Compare Ranges Index with Condition Code

```
e = vec_cmprg_idx_cc(a, b, c, d)
```

Returns the lowest byte-index of the element of a that is within any of the ranges specified by b and c. Each even-odd element pairs of b define values for the limits of the ranges. The corresponding even-odd pairs of elements in c control how the comparison to be performed, in the following way:

Comparison	for vector unsigned char	for vector unsigned short	for vector unsigned int
ignore - result of comparison always TRUE	0	0	0
equal	0x80	0x8000	0x80000000
not equal	0x60	0x6000	0x60000000
greater than	0x20	0x2000	0x20000000

Comparison	for vector unsigned char	for vector unsigned short	for vector unsigned int
greater than or equal	0xA0	0xA000	0xA0000000
less than	0x40	0x4000	0x40000000
less than and equal	0xC0	0xC000	0xC0000000
force to FALSE	0xE0	0xE000	0xE0000000

d is set to 1, if there is at least one element of a found in any of the ranges. Otherwise, d is set to 3.

The result is placed into byte element seven of the returned vector, and all other bytes are set to 0.

Table 202. Vector Compare Ranges Index with Condition Code

e	a	b	c	d
vector unsigned char	vector unsigned char	vector unsigned char	vector unsigned char	int *
vector unsigned short	vector unsigned short	vector unsigned short	vector unsigned short	
vector unsigned int	vector unsigned int	vector unsigned int	vector unsigned int	

### vec\_cmprg\_or\_0\_idx: Vector Compare Ranges or Zero Index

d = vec\_cmprg\_or\_0\_idx(a, b, c)

Returns the lowest byte-index of the element of a that is 0 or within any of the ranges specified by b and c. Each even-odd element pairs of b define values for the limits of the ranges. The corresponding even-odd pairs of elements in c control how the comparison to be performed, in the following way:

Comparison	for vector unsigned char	for vector unsigned short	for vector unsigned int
ignore - result of comparison always TRUE	0	0	0
equal	0x80	0x8000	0x80000000
not equal	0x60	0x6000	0x60000000
greater than	0x20	0x2000	0x20000000
greater than or equal	0xA0	0xA000	0xA0000000
less than	0x40	0x4000	0x40000000
less than and equal	0xC0	0xC000	0xC0000000
force to FALSE	0xE0	0xE000	0xE0000000

The result is the lowest byte-index from element of a that is 0 or contained in any of the specified ranges. Otherwise, the result is 16.

The result is placed into byte element seven of the returned vector, and all other bytes are set to 0.

Table 203. Vector Compare Ranges or Zero Index

d	a	b	c
vector unsigned char	vector unsigned char	vector unsigned char	vector unsigned char
vector unsigned short	vector unsigned short	vector unsigned short	vector unsigned short
vector unsigned int	vector unsigned int	vector unsigned int	vector unsigned int

Example:

```
vector unsigned int a = {1, 0, 22, 33};
vector unsigned int b = {10, 20, 30, 40};
vector unsigned int c = {0x20000000, 0x40000000, 0x20000000,
                        0x40000000}; // {GT, LT, GT, LT}
```

```
vector unsigned int d = vec_cmprg_or_0_idx(a, b, c); // byte 7 of d = 4
```

In this example, each element of a is tested to be (equals to 0) OR (> 10 AND < 5) OR (>30 AND < 40), the second element (byte index 4) is the first element satisfying the condition.

### **vec\_cmprg\_or\_0\_idx\_cc: Vector Compare Ranges or Zero Index with Condition Code**

```
e = vec_cmprg_or_0_idx_cc(a, b, c, d)
```

Returns the lowest byte-index of the element of a that is 0 or within any of the ranges specified by b and c. Each even-odd element pairs of b define values for the limits of the ranges. The corresponding even-odd pairs of elements in c control how the comparison to be performed, in the following way:

Comparison	for vector unsigned char	for vector unsigned short	for vector unsigned int
ignore - result of comparison always TRUE	0	0	0
equal	0x80	0x8000	0x80000000
not equal	0x60	0x6000	0x60000000
greater than	0x20	0x2000	0x20000000
greater than or equal	0xA0	0xA000	0xA0000000
less than	0x40	0x4000	0x40000000
less than and equal	0xC0	0xC000	0xC0000000
force to FALSE	0xE0	0xE000	0xE0000000

d is set to one of the following:

- 0 - if 0 was found on an element of a, before an element was found within the specified range.
- 1 - if no element of a is 0, and there is at least one element of a found in any of the ranges.
- 2 - if 0 was found on an element of a after an element was found within the specified range.
- 3 - no element is 0 and found to be within any of the specified range.

The result is placed into byte element seven of the returned vector, and all other bytes are set to 0.

Table 204. Vector Compare Ranges or Zero Index with Condition Code

e	a	b	c	d
vector unsigned char	vector unsigned char	vector unsigned char	vector unsigned char	int *
vector unsigned short	vector unsigned short	vector unsigned short	vector unsigned short	
vector unsigned int	vector unsigned int	vector unsigned int	vector unsigned int	

## Find Any Element

This section describes vector built-in functions for element searching.

### **vec\_find\_any\_eq: Vector Find Any Element Equal**

```
d = vec_find_any_eq(a, b)
```

Find element of a from any element of b with an equal value.

For each element of the result, the value of each bit is 1 if the corresponding elements of a equal any element of b. Otherwise, the value of each bit is 0.

Table 205. Vector Find Any Element Equal

d	a	b
vector bool char	vector signed char	vector signed char
	vector bool char	vector bool char
	vector unsigned char	vector unsigned char
vector bool short	vector signed short	vector signed short
	vector bool short	vector bool short
	vector unsigned short	vector unsigned short
vector bool int	vector signed int	vector signed int
	vector bool int	vector bool int
	vector unsigned int	vector unsigned int

Example:

```
vector signed int a = {1, -2, 3, -4};
vector signed int b = {-5, 3, -7, 8};
```

```
vector bool int d = vec_find_any_eq(a, b); // d = {0, 0, 0xFFFFFFFF, 0}
```

### **vec\_find\_any\_eq\_cc: Vector Find Any Element Equal with Condition Code**

```
d = vec_find_any_eq_cc(a, b, c)
```

Find element of a from any element of b with an equal value.

For each element of the result, the value of each bit is 1 if the corresponding elements of a equal any element of b. Otherwise, the value of each bit is 0. c is set to 1, if there is at least one element of a find a match with b, otherwise c is set to 3.

Table 206. Vector Find Any Element Equal with Condition Code

d	a	b	c
vector bool char	vector signed char	vector signed char	int *
	vector bool char	vector bool char	
	vector unsigned char	vector unsigned char	
vector bool short	vector signed short	vector signed short	
	vector bool short	vector bool short	
	vector unsigned short	vector unsigned short	
vector bool int	vector signed int	vector signed int	
	vector bool int	vector bool int	
	vector unsigned int	vector unsigned int	

### vec\_find\_any\_eq\_idx: Vector Find Any Element Equal Index

d = vec\_find\_any\_eq\_idx(a, b)

Find the lowest byte-index of element of a from any element of b with an equal value. The result is the lowest byte-index from element of a, if it is found. Otherwise, the result is 16.

The result is placed into byte element seven of the returned vector, and all other bytes are set to 0.

Table 207. Vector Find Any Element Equal Index

d	a	b
vector signed char	vector signed char	vector signed char
vector unsigned char	vector bool char	vector bool char
	vector unsigned char	vector unsigned char
vector signed short	vector signed short	vector signed short
vector unsigned short	vector bool short	vector bool short
	vector unsigned short	vector unsigned short
vector signed int	vector signed int	vector signed int
vector unsigned int	vector bool int	vector bool int
	vector unsigned int	vector unsigned int

Example 1:

```
vector unsigned int a = {1, 2, 3, 4};
vector unsigned int b = {5, 3, 7, 8};
```

```
vector unsigned int d = vec_find_any_eq_idx(a,b); // byte 7 of d = 8
```

In this example, the third element (byte index 8) of a was found in the vector b.

Example 2:

```
vector unsigned int a = {1, 2, 3, 4};
vector unsigned int b = {5, 6, 7, 8};
```

```
vector unsigned int d = vec_find_any_eq_idx(a,b); // byte 7 of d = 16
```

In this example, no element from a was found in b, so 16 is returned.

## vec\_find\_any\_eq\_idx\_cc: Vector Find Any Element Equal Index with Condition Code

```
d = vec_find_any_eq_idx_cc(a, b, c)
```

Find the lowest byte-index of element of a from any element of b with an equal value. If it is found, the result is the lowest byte-index from element of a, and c is set to 1. Otherwise, the result is 16, with c set to 3.

The result is placed into byte element seven of the returned vector, and all other bytes are set to 0.

Table 208. Vector Find Any Element Equal Index with Condition Code

d	a	b	c
vector signed char	vector signed char	vector signed char	int *
vector unsigned char	vector bool char	vector bool char	
	vector unsigned char	vector unsigned char	
vector signed short	vector signed short	vector signed short	
vector unsigned short	vector bool short	vector bool short	
	vector unsigned short	vector unsigned short	
vector signed int	vector signed int	vector signed int	
vector unsigned int	vector bool int	vector bool int	
	vector unsigned int	vector unsigned int	

Example 1:

```
vector unsigned int a = {1, 2, 3, 4};  
vector unsigned int b = {5, 3, 7, 8};  
int c = 0;
```

```
vector unsigned int d = vec_find_any_eq_idx_cc(a,b,&c); // byte 7 of d = 8, c = 1
```

In this example, the third element (byte index 8) of a was found in the vector b.

Example 2:

```
vector unsigned int a = {1, 2, 3, 4};  
vector unsigned int b = {5, 6, 7, 8};  
int c = 0;
```

```
vector unsigned int d = vec_find_any_eq_idx_cc(a,b,&c); // byte 7 of d = 16, c = 3
```

In this example, the no element from a was found in b, so 16 is returned.

## vec\_find\_any\_eq\_or\_0\_idx: Vector Find Any Element Equal or Zero Index

```
d = vec_find_any_eq_or_0_idx(a, b)
```

Find the byte-index of element of a from any element of b with an equal value, or the byte-index of element of a is 0. The result is the lowest byte-index from element of a, if it is found to match those conditions. Otherwise, the result is 16.

The result is placed into byte element seven of the returned vector, and all other bytes are set to 0.

Table 209. Vector Find Any Element Equal or Zero Index

d	a	b
vector signed char	vector signed char	vector signed char
vector unsigned char	vector bool char	vector bool char
	vector unsigned char	vector unsigned char
vector signed short	vector signed short	vector signed short
vector unsigned short	vector bool short	vector bool short
	vector unsigned short	vector unsigned short
vector signed int	vector signed int	vector signed int
vector unsigned int	vector bool int	vector bool int
	vector unsigned int	vector unsigned int

Example:

```
vector unsigned int a = {1, 2, 0, 4};
vector unsigned int b = {5, 6, 7, 8};
```

```
vector unsigned int d = vec_find_any_eq_or_0_idx(a,b); // byte 7 of d = 8
```

In this example, the first and second elements of a are not found in the vector b, and the third element (byte index 8) is a 0.

### **vec\_find\_any\_eq\_or\_0\_idx\_cc: Vector Find Any Element Equal or Zero Index with Condition Code**

```
d = vec_find_any_eq_or_0_idx_cc(a, b, c)
```

Find the byte-index of element of a from any element of b with an equal value, or the byte-index of element of a is 0. The result is the lowest byte-index from element of a, if it is found to match those conditions. Otherwise, the result is 16.

c would be set to one of the following values:

- 0 - if no element of a matches any element of b with an equal value, and there is at least one element from a with a value of 0.
- 1 - if at least one element of a matches any element of b with an equal value, and no elements of a with a value of 0.
- 2 - if at least one element of a matches any element of b with an equal value, and there is at least one element from a has a value of 0.
- 3 - if no element of a matches any element of b with an equal value, and there is no element from a with a value of 0.

The result is placed into byte element seven of the returned vector, and all other bytes are set to 0.

Table 210. Vector Find Any Element Equal or Zero Index with Condition Code

d	a	b	c
vector signed char	vector signed char	vector signed char	int *
vector unsigned char	vector bool char	vector bool char	
	vector unsigned char	vector unsigned char	
vector signed short	vector signed short	vector signed short	
vector unsigned short	vector bool short	vector bool short	
	vector unsigned short	vector unsigned short	
vector signed int	vector signed int	vector signed int	
vector unsigned int	vector bool int	vector bool int	
	vector unsigned int	vector unsigned int	

### vec\_find\_any\_ne: Vector Find Any Element Not Equal

`d = vec_find_any_ne(a, b)`

Find element of a from any element of b with a not equal value.

For each element of the result, the value of each bit is 1 if the corresponding elements of a does not equal to any element of b. Otherwise, the value of each bit is 0.

Table 211. Vector Find Any Element Not Equal

d	a	b
vector bool char	vector signed char	vector signed char
	vector bool char	vector bool char
	vector unsigned char	vector unsigned char
vector bool short	vector signed short	vector signed short
	vector bool short	vector bool short
	vector unsigned short	vector unsigned short
vector bool int	vector signed int	vector signed int
	vector bool int	vector bool int
	vector unsigned int	vector unsigned int

Example:

```
vector signed int a = {1, -2, 3, -4};
vector signed int b = {-5, 3, -7, 8};
```

```
vector bool int d = vec_find_any_ne(a, b);
// d = {0xFFFFFFFF, 0xFFFFFFFF, 0, 0xFFFFFFFF}
```

### vec\_find\_any\_ne\_cc: Vector Find Any Element Not Equal with Condition Code

`d = vec_find_any_ne_cc(a, b, c)`

Find element of a from any element of b with a not equal value.



For each element of the result, the value of each bit is 1 if the corresponding elements of a does not equal to any element of b. Otherwise, the value of each bit is 0. c is set to 1, if there is at least one element of a didn't find a match with b, otherwise c is set to 3.

Table 212. Vector Find Any Element Not Equal with Condition Code

d	a	b	c
vector bool char	vector signed char	vector signed char	int *
	vector bool char	vector bool char	
	vector unsigned char	vector unsigned char	
vector bool short	vector signed short	vector signed short	
	vector bool short	vector bool short	
	vector unsigned short	vector unsigned short	
vector bool int	vector signed int	vector signed int	
	vector bool int	vector bool int	
	vector unsigned int	vector unsigned int	

### vec\_find\_any\_ne\_idx: Vector Find Any Element Not Equal Index

d = vec\_find\_any\_ne\_idx(a, b)

Find the lowest byte-index of element of a from any element of b with a not equal value. The result is the lowest byte-index from element of a, if it is found. Otherwise, the result is 16.

The result is placed into byte element seven of the returned vector, and all other bytes are set to 0.

Table 213. Vector Find Any Element Not Equal Index

d	a	b
vector signed char	vector signed char	vector signed char
vector unsigned char	vector bool char	vector bool char
	vector unsigned char	vector unsigned char
vector signed short	vector signed short	vector signed short
vector unsigned short	vector bool short	vector bool short
	vector unsigned short	vector unsigned short
vector signed int	vector signed int	vector signed int
vector unsigned int	vector bool int	vector bool int
	vector unsigned int	vector unsigned int

Example 1:

```
vector unsigned int a = {1, 2, 3, 4};
vector unsigned int b = {1, 5, 3, 4};
```

```
vector unsigned int d = vec_find_any_ne_idx(a,b); // byte 7 of d = 4
```

In this example, the second element (byte index 4) of a was found to be not equal to any element in b.

Example 2:

```
vector unsigned int a = {1, 2, 3, 4};
vector unsigned int b = {1, 2, 3, 4};
```

```
vector unsigned int d = vec_find_any_ne_idx(a,b); // byte 7 of d = 16
```

In this example, no element from a was found to be not equal to any element in b, so 16 is returned.

### **vec\_find\_any\_ne\_idx\_cc: Vector Find Any Element Not Equal Index with Condition Code**

```
d = vec_find_any_ne_idx_cc(a, b, c)
```

Find the lowest byte-index of element of a from any element of b with a not equal value. If it is found, the result is the lowest byte-index from element of a, and c is set to 1. Otherwise, the result is 16, with c set to 3.

The result is placed into byte element seven of the returned vector, and all other bytes are set to 0.

*Table 214. Vector Find Any Element Not Equal Index with Condition Code*

<b>d</b>	<b>a</b>	<b>b</b>	<b>c</b>
vector signed char	vector signed char	vector signed char	int *
vector unsigned char	vector bool char	vector bool char	
	vector unsigned char	vector unsigned char	
vector signed short	vector signed short	vector signed short	
vector unsigned short	vector bool short	vector bool short	
	vector unsigned short	vector unsigned short	
vector signed int	vector signed int	vector signed int	
vector unsigned int	vector bool int	vector bool int	
	vector unsigned int	vector unsigned int	

Example 1:

```
vector unsigned int a = {1, 2, 3, 4};
vector unsigned int b = {1, 5, 3, 4};
int c = 0;
```

```
vector unsigned int d = vec_find_any_ne_idx_cc(a,b,&c); // byte 7 of d = 4, c = 1
```

In this example, the second element (byte index 4) of a was found to be not equal to any element in the vector b.

Example 2:

```
vector unsigned int a = {1, 2, 3, 4};
vector unsigned int b = {1, 2, 3, 4};
int c = 0;
```

```
vector unsigned int d = vec_find_any_ne_idx_cc(a,b,&c); // byte 7 of d = 16, c = 3
```

### **vec\_find\_any\_ne\_or\_0\_idx: Vector Find Any Element Not Equal or Zero Index**

```
d = vec_find_any_ne_or_0_idx(a, b)
```

Find the byte-index of element of a from any element of b with a not equal value, or the byte-index of element of a is 0. The result is the lowest byte-index from element of a, if it is found to match those conditions. Otherwise, the result is 16.

The result is placed into byte element seven of the returned vector, and all other bytes are set to 0.

Table 215. Vector Find Any Element Not Equal or Zero Index

d	a	b
vector signed char	vector signed char	vector signed char
vector unsigned char	vector bool char	vector bool char
	vector unsigned char	vector unsigned char
vector signed short	vector signed short	vector signed short
vector unsigned short	vector bool short	vector bool short
	vector unsigned short	vector unsigned short
vector signed int	vector signed int	vector signed int
vector unsigned int	vector bool int	vector bool int
	vector unsigned int	vector unsigned int

Example:

```
vector unsigned int a = {1, 2, 0, 4};
```

```
vector unsigned int b = {1, 2, 3, 4};
```

```
vector unsigned int d = vec_find_any_ne_or_0_idx(a,b); // byte 7 of d = 8
```

In this example, the first and second elements of a are found in the vector b, and the third element (byte index 8) is a 0.

### **vec\_find\_any\_ne\_or\_0\_idx\_cc: Vector Find Any Element Not Equal or Zero Index with Condition Code**

```
d = vec_find_any_ne_or_0_idx_cc(a, b, c)
```

Find the byte-index of element of a from any element of b with a not equal value, or the byte-index of element of a is 0. The result is the lowest byte-index from element of a, if it is found to match those conditions. Otherwise, the result is 16.

c would be set to one of the following values:

- 0 - if no element of a matches any element of b with a not equal value, and there is at least one element from a with a value of 0.
- 1 - if at least one element of a matches any element of b with a not equal value, and no elements of a with a value of 0.
- 2 - if at least one element of a matches any element of b with a not equal value, and there is at least one element from a has a value of 0.
- 3 - if no element of a matches any element of b with a not equal value, and there is no element from a with a value of 0.

The result is placed into byte element seven of the returned vector, and all other bytes are set to 0.

Table 216. Vector Find Any Element Not Equal or Zero Index with Condition Code

d	a	b	c
vector signed char	vector signed char	vector signed char	int *
vector unsigned char	vector bool char	vector bool char	
	vector unsigned char	vector unsigned char	
vector signed short	vector signed short	vector signed short	
vector unsigned short	vector bool short	vector bool short	
	vector unsigned short	vector unsigned short	
vector signed int	vector signed int	vector signed int	
vector unsigned int	vector bool int	vector bool int	
	vector unsigned int	vector unsigned int	

## Gather and Scatter

This section describes vector built-in functions for gathering and scattering elements.

### vec\_extract: Vector Extract

`d = vec_extract(a, b)`

Returns the value of element `b` from the vector `a`. This function uses the modulo arithmetic on `b` to determine the element number. For example, if `b` is out of range, the compiler uses `b` modulo the number of elements in the vector to determine the element position.

Table 217. Vector Extract

d	a	b
signed char	vector signed char	signed int
unsigned char	vector bool char	
	vector unsigned char	
signed short	vector signed short	
unsigned short	vector bool short	
	vector unsigned short	
signed int	vector signed int	
unsigned int	vector bool int	
	vector unsigned int	
signed long long	vector signed long long	
unsigned long long	vector bool long long	
	vector unsigned long long	
double	vector double	

### vec\_gather\_element: Vector Gather Element

`e = vec_gather_element(a, b, c, d)`

Returns a copy of the vector `a` with the value of its element `d` replaced by `*(c+b[d])`.

Table 218. Vector Gather Element

e	a	b	c	d
vector signed int	vector signed int	vector unsigned int	const signed int *	0-3
vector bool int	vector bool int		const unsigned int *	
vector unsigned int	vector unsigned int			
vector signed long long	vector signed long long	vector unsigned long long	const signed long long *	0-1
vector bool long long	vector bool long long		const unsigned long long *	
vector unsigned long long	vector unsigned long long			
vector double	vector double	vector unsigned long long	const double *	0-1

Example:

```
unsigned int a1[10] = {10, 11, 12, 13, 14, 15, 16, 17, 18, 19};
unsigned int a2[10] = {20, 21, 22, 23, 24, 25, 26, 27, 28, 29};
vector unsigned int v1= {1, 2, 3, 4}, v2 = {1, 2, 3, 4};
vector unsigned int v3 = {5 * sizeof(int), 8 * sizeof(int),
                        9 * sizeof(int), 6 * sizeof(int)};
```

```
v1 = vec_gather_element (v1, v3, a1, 0); // v1 = {15, 2, 3, 4}
v2 = vec_gather_element (v2, v3, a2, 0); // v2 = {25, 2, 3, 4}
```

### vec\_insert: Vector Insert

```
d = vec_insert(a, b, c)
```

Returns a copy of the vector b with the value of its element c replaced by a. This function uses the modulo arithmetic on c to determine the element number. For example, if c is out of range, the compiler uses c modulo the number of elements in the vector to determine the element position.

Table 219. Vector Insert

d	a	b	c
vector signed char	signed char	vector signed char	signed int
vector unsigned char	unsigned char	vector bool char	
		vector unsigned char	
vector signed short	signed short	vector signed short	
vector unsigned short	unsigned short	vector bool short	
		vector unsigned short	
vector signed int	signed int	vector signed int	
vector unsigned int	unsigned int	vector bool int	
		vector unsigned int	
vector signed long long	signed long long	vector signed long long	
vector unsigned long long	unsigned long long	vector bool long long	
		vector unsigned long long	
vector double	double	vector double	

### vec\_insert\_and\_zero: Vector Insert and Zero

d = vec\_insert\_and\_zero(a)

Returns vector d with the rightmost sub-element or element of the leftmost doubleword element set to what is pointed to by a. The bit positions of all other elements are set to zero.

Table 220. Vector Insert and Zero

d	a
vector unsigned char	const unsigned char *
vector signed char	const signed char *
vector unsigned short	const unsigned short *
vector signed short	const signed short *
vector unsigned int	const unsigned int *
vector signed int	const signed int *
vector unsigned long long	const unsigned long long *
vector signed long long	const signed long long *
vector double	const double *

### vec\_perm: Vector Permute

d = vec\_perm(a, b, c)

Returns a vector that contains some elements of two vectors, in the order specified by a third vector.

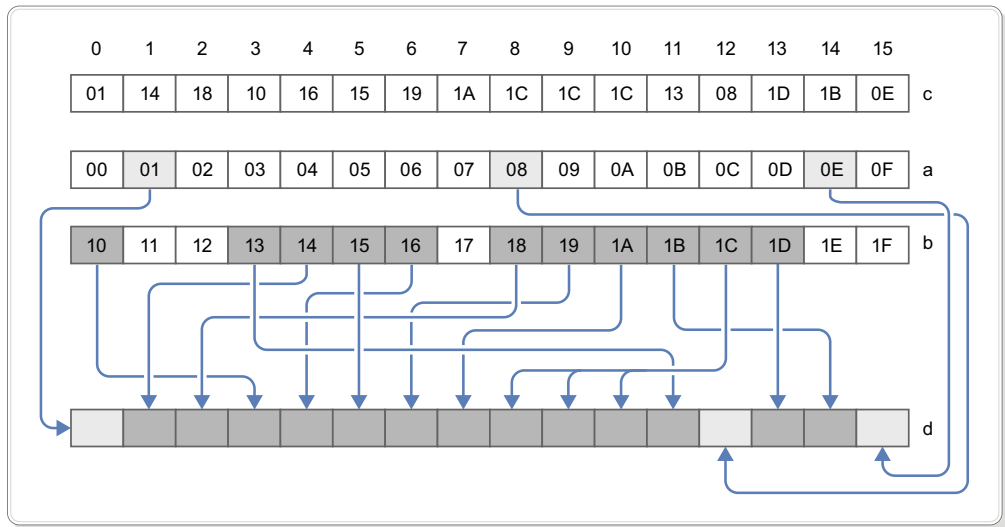

Figure 158. Permute 16 integer elements (8-bit)

Each byte of the result is selected by using the least significant 5 bits of the corresponding byte of *c* as an index into the concatenated bytes of *a* and *b*.

**Note:** The vector generate mask built-in functions could help generate the mask *c*.

Table 221. Vector Permute

d	a	b	c
vector signed char	vector signed char	vector signed char	vector unsigned char
vector bool char	vector bool char	vector bool char	
vector unsigned char	vector unsigned char	vector unsigned char	
vector signed short	vector signed short	vector signed short	
vector bool short	vector bool short	vector bool short	
vector unsigned short	vector unsigned short	vector unsigned short	
vector signed int	vector signed int	vector signed int	
vector bool int	vector bool int	vector bool int	
vector unsigned int	vector unsigned int	vector unsigned int	
vector signed long long	vector signed long long	vector signed long long	
vector bool long long	vector bool long long	vector bool long long	
vector unsigned long long	vector unsigned long long	vector unsigned long long	
vector double	vector double	vector signed double	

### vec\_permi: Vector Permute Immediate

$d = \text{vec\_permi}(a, b, c)$

Returns a vector by permuting and combining the two eight-byte-long vector elements in *a* and *b* based on the value of *c*.

If you use `a[0]` and `a[1]` to represent the first and second eight-byte-long elements in `a`, and likewise use `b[0]` and `b[1]` for elements in `b`, this function determines the elements in the result vector based on the binary value of `c`.

The value of `c` can be:

- 0 (b'00') - `a[0]`, `b[0]`
- 1 (b'01') - `a[0]`, `b[1]`
- 2 (b'10') - `a[1]`, `b[0]`
- 3 (b'11') - `a[1]`, `b[1]`

Table 222. Vector Permute Immediate

d	a	b	c
vector bool long long	vector bool long long	vector bool long long	0 - 3
vector signed long long	vector signed long long	vector signed long long	
vector unsigned long long	vector unsigned long long	vector unsigned long long	
vector double	vector double	vector double	

### **vec\_promote: Vector Promote**

`d = vec_promote(a, b)`

Returns a vector with `a` in element position `b`. The result is a vector with `a` in element position `b`. This function uses modulo arithmetic on `b` to determine the element number. For example, if `b` is out of range, the compiler uses `b` modulo the number of elements in the vector to determine the element position. The other elements of the vector are undefined.

Table 223. Vector Promote

d	a	b
vector signed char	signed char	signed int
vector unsigned char	unsigned char	
vector signed short	signed short	
vector unsigned short	unsigned short	
vector signed int	signed int	
vector unsigned int	unsigned int	
vector signed long long	signed long long	
vector unsigned long long	unsigned long long	
vector double	double	

### **vec\_scatter\_element: Vector Scatter Element**

`vec_scatter_element(a, b, c, d)`

Store vector element `a[d]` to `*(c+b[d])`.



Table 224. Vector Scatter Element

a	b	c	d
vector signed int	vector unsigned int	signed int *	0 - 3
vector bool int		unsigned int *	
vector unsigned int			
vector signed long long	vector unsigned long long	signed long long *	0 - 1
vector bool long long		unsigned long long *	
vector unsigned long long			
vector double	vector unsigned long long	double *	0 - 1

### vec\_sel: Vector Select

`d = vec_sel(a, b, c)`

Returns a vector containing the value of either a or b depending on the value of c. Each bit of the result vector has the value of the corresponding bit of a if the corresponding bit of c is 0, or the value of the corresponding bit of b otherwise.

Table 225. Vector Select

d	a	b	c
vector bool char	vector bool char	vector bool char	vector bool char
			vector unsigned char
vector signed char	vector signed char	vector signed char	vector bool char
			vector unsigned char
vector unsigned char	vector unsigned char	vector unsigned char	vector bool char
			vector unsigned char
vector bool short	vector bool short	vector bool short	vector bool short
			vector unsigned short
vector signed short	vector signed short	vector signed short	vector bool shot
			vector unsigned short
vector unsigned short	vector unsigned short	vector unsigned short	vector bool short
			vector unsigned short
vector bool int	vector bool int	vector bool int	vector bool int
			vector unsigned int
vector signed int	vector signed int	vector signed int	vector bool int
			vector unsigned int
vector unsigned int	vector unsigned int	vector unsigned int	vector bool int
			vector unsigned int
vector bool long long	vector bool long long	vector bool long long	vector bool long long
			vector unsigned long long

Table 225. Vector Select (continued)

d	a	b	c
vector signed long long	vector signed long long	vector signed long long	vector bool long long
			vector unsigned long long
vector unsigned long long	vector unsigned long long	vector unsigned long long	vector bool long long
			vector unsigned long long
vector double	vector double	vector double	vector bool long long
			vector unsigned long long

Example:

```
vector signed int a = {1, 2, 3, 4};
vector signed int b = {5, 6, 7, 8};
```

```
vector unsigned int e = {9, 10, 11, 12};
vector unsigned int f = {9, 9, 11, 11};
```

```
vector bool int c = vec_cmpeq(e, f); // c = {0xFFFFFFFF, 0, 0xFFFFFFFF, 0};
vector signed int d = vec_sel(a, b, c); // d = {5, 2, 7, 4}
```

## Generate Mask

This section describes vector built-in functions for generating mask.

### vec\_genmask: Vector Generate Byte Mask

```
d = vec_genmask(a)
```

Generates byte masks for elements in the return vector. For each bit in a, if the bit is one, all bit positions in the corresponding byte element of d are set to ones. Otherwise, if the bit is zero, the corresponding byte element is set to zero.

Table 226. Vector Generate Byte Mask

d	a
vector unsigned char	unsigned short literal

### vec\_genmasks\_8: Vector Generate Mask (Byte)

```
d = vec_genmasks_8(a, b)
```

Generates bit masks for elements in the return vector. For each byte element in d, a bit mask is generated. The mask consists of bits set to one starting at the bit position specified by a and ending with the bit position specified by b. All other bit positions are set to zero.

#### Notes:

- If a or b is greater than 8, the operation is performed as if the value gets modulo by 8.
- If a is greater than b, the operation is performed as if b equals 7.

Table 227. Vector Generate Mask (Byte)

d	a	b
vector unsigned char	0-255	0-255

### vec\_genmasks\_16: Vector Generate Mask (Halfword)

d = vec\_genmasks\_16(a, b)

Generates bit masks for elements in the return vector. For each halfword element in d, a bit mask is generated. The mask consists of bits set to one starting at the bit position specified by a and ending with the bit position specified by b. All other bit positions are set to zero.

**Notes:**

- If a or b is greater than 16, the operation is performed as if the value gets modulo by 16.
- If a is greater than b, the operation is perform as if b equals 15.

Table 228. Vector Generate Mask (Halfword)

d	a	b
vector unsigned short	0 - 255	0 - 255

### vec\_genmasks\_32: Vector Generate Mask (Word)

d = vec\_genmasks\_32(a, b)

Generates bit masks for elements in the return vector. For each element in d, a bit mask is generated. The mask consists of bits set to one starting at the bit position specified by a and ending with the bit position specified by b. All other bit positions are set to zero.

**Notes:**

- If a or b is greater than 32, the operation is performed as if the value gets modulo by 32.
- If a is greater than b, the operation is perform as if b equals 31.

Table 229. Vector Generate Mask (Word)

d	a	b
vector unsigned int	0-255	0-255

### vec\_genmasks\_64: Vector Generate Mask (Doubleword)

d = vec\_genmasks\_64(a, b)

Generates bit masks for elements in the return vector. For each doubleword element in d, a bit mask is generated. The mask consists of bits set to one starting at the bit position specified by a and ending with the bit position specified by b. All other bit positions are set to zero.

**Notes:**

- If a or b is greater than 64, the operation is performed as if the value gets modulo by 64.
- If a is greater than b, the operation is perform as if b equals 63.

Table 230. Vector Generate Mask (Doubleword)

d	a	b
vector unsigned long long	0-255	0-255

## Copy until Zero

This section describes vector built-in functions for copying until a zero is encountered.

### **vec\_cp\_until\_zero: Vector Copy Until Zero**

`d = vec_cp_until_zero(a)`

Copies the vector elements from a to d, starting from vector element 0, until the vector element from a contains a value of 0, or the entire vector is copied. The remaining vector elements in d are set to 0.

Table 231. Vector Copy Until Zero

d	a
vector signed char	vector signed char
vector bool char	vector bool char
vector unsigned char	vector unsigned char
vector signed short	vector signed short
vector bool short	vector bool short
vector unsigned short	vector unsigned short
vector signed int	vector signed int
vector bool int	vector bool int
vector unsigned int	vector unsigned int

### **vec\_cp\_until\_zero\_cc: Vector Copy Until Zero**

`d = vec_cp_until_zero_cc(a, b)`

Copies the vector elements from a to d, starting from vector element 0, until the vector element from a contains a value of 0, or the entire vector is copied. The remaining vector elements in d are set to 0.

c is set to 0, if the entire vector was not copied, due to an element from a contains a value of 0. Otherwise, if all elements of a are non-zero, c is set to 3.

Table 232. Vector Copy Until Zero

d	a	b
vector signed char	vector signed char	int *
vector bool char	vector bool char	
vector unsigned char	vector unsigned char	
vector signed short	vector signed short	
vector bool short	vector bool short	
vector unsigned short	vector unsigned short	
vector signed int	vector signed int	
vector bool int	vector bool int	
vector unsigned int	vector unsigned int	

## Load and Store

This section describes vector built-in functions for loading and storing vectors.

### vec\_ld2f: Vector Load 2 float

d = vec\_ld2f(a)

Loads 2 consecutive float (total 8-bytes) from the address specified in a, and extended them as a vector double.

**Note:** This function is emulated.

Table 233. Vector Load 2 float

d	a
vector double	const float *

### vec\_load\_bndry: Vector Load to Block Boundary

d = vec\_load\_bndry(a, b)

Returns a vector with content loaded from \*a, filling the vector starting at byte 0, up to 16 bytes or the byte boundary specified by b. When a boundary condition is encountered, the rest of the bytes in the resulting vector are undefined.

Table 234. Vector Load to Block Boundary

d	a	b
vector signed char	const signed char *	64, 128, 256, 512, 1024, 2048, or 4096
vector unsigned char	const unsigned char *	
vector signed short	const signed short *	
vector unsigned short	const unsigned short *	
vector signed int	const signed int *	
vector unsigned int	const unsigned int *	
vector signed long long	const signed long long *	
vector unsigned long long	const unsigned long long *	
vector double	const double *	

## vec\_load\_len: Vector Load with Length

d = vec\_load\_len(a, b)

Returns a vector with content loaded from \*a, filling the vector starting at byte 0, up to the number of bytes specified by b+1. When b is less than 15, the remaining bytes of the returned vector are set to zero. When b is greater than 15, only 16 bytes are loaded.

Table 235. Vector Load with Length

d	a	b
vector signed char	const signed char *	unsigned int
vector unsigned char	const unsigned char *	
vector signed short	const signed short *	
vector unsigned short	const unsigned short *	
vector signed int	const signed int *	
vector unsigned int	const unsigned int *	
vector signed long long	const signed long long *	
vector unsigned long long	const unsigned long long *	
vector double	const double *	

## vec\_load\_pair: Vector Load Pair

d = vec\_load\_pair(a, b)

Returns a vector with a on the 0-indexed element, and b on the 1-indexed element.

**Note:** This function might be emulated.

Table 236. Vector Load Pair

d	a	b
vector signed long long	signed long long	signed long long
vector unsigned long long	unsigned long long	unsigned long long

## vec\_st2f: Vector Store 2 float

vec\_st2f(a, b)

Rounds the vector double a as 2 float, and stores them to 2 consecutive location (total 8-bytes) as specified by b.

**Note:** This function is emulated.

Table 237. Vector Store 2 float

a	b
vector double	float *

## vec\_store\_len: Vector Store with Length

vec\_store\_len(a, b, c)

Store c+1 number of bytes to \*b from the vector a.

**Note:** If c is greater than 15, only 16 bytes will be stored.

Table 238. Vector Store with Length

a	b	c
vector signed char	signed char *	unsigned int
vector unsigned char	unsigned char *	
vector signed short	signed short *	
vector unsigned short	unsigned short *	
vector signed int	signed int *	
vector unsigned int	unsigned int *	
vector signed long long	signed long long *	
vector unsigned long long	unsigned long long *	
vector double	double *	

### vec\_xld2: Vector Load 2 Doubleword

d = vec\_xld2(a, b)

Loads a 16-byte vector from two 8-byte elements at the memory address specified by the displacement a and the pointer b. This function adds the displacement and the pointer R-value to obtain the address for the load operation.

Table 239. Vector Load 2 Doubleword

d	a	b
vector signed char	long	signed char *
vector unsigned char		unsigned char *
vector signed short		signed short *
vector unsigned short		unsigned short *
vector signed int		signed int *
vector unsigned int		unsigned int *
vector signed long long		signed long long *
vector unsigned long long		unsigned long long *
vector double		double *

### vec\_xlw4: Vector Load 4 Word

d = vec\_xlw4(a, b)

Loads a 16-byte vector from four 4-byte elements at the memory address specified by the displacement a and the pointer b. This function adds the displacement and the pointer R-value to obtain the address for the load operation.

Table 240. Vector Load 4 Word

d	a	b
vector signed char	long	signed char *
vector unsigned char		unsigned char *
vector signed short		signed short *
vector unsigned short		unsigned short *
vector signed int		signed int *
vector unsigned int		unsigned int *

## vec\_xstd2: Vector Store 2 Doubleword

d = vec\_xstd2(a, b, c)

Puts a 16-byte vector a as two 8-byte elements to the memory address specified by the displacement b and the pointer c. This function adds the displacement and the pointer R-value to obtain the address for the store operation.

Table 241. Vector Store 2 Doubleword

d	a	b	c
void	vector signed char	long	signed char *
	vector unsigned char		unsigned char *
	vector signed short		signed short *
	vector unsigned short		unsigned short *
	vector signed int		signed int *
	vector unsigned int		unsigned int *
	vector signed long long		signed long long *
	vector unsigned long long		unsigned long long *
	vector double		double *

## vec\_xstw4: Vector Store 4 Word

d = vec\_xstw4(a, b, c)

Puts a 16-byte vector a to four 4-byte elements at the memory address specified by the displacement b and the pointer c. This function adds the displacement and the pointer R-value to obtain the address for the store operation.

Table 242. Vector Store 4 Word

d	a	b	c
void	vector signed char	long	signed char *
	vector unsigned char		unsigned char *
	vector signed short		signed short *
	vector unsigned short		unsigned short *
	vector signed int		signed int *
	vector unsigned int		unsigned int *

## Logical

This section describes vector built-in functions for logical calculation.

### vec\_cntlz: Vector Count Leading Zeros

d = vec\_cntlz(a)

Computes the count of leading zero bits of each element of the input.

Each element of the result is set to the number of leading zeros of the corresponding element of a.



Table 243. Vector Count Leading Zeros

d	a
vector unsigned char	vector unsigned char
	vector signed char
vector unsigned short	vector unsigned short
	vector signed short
vector unsigned int	vector unsigned int
	vector signed int
vector unsigned long long	vector unsigned long long
	vector signed long long

### vec\_cnttz: Vector Count Trailing Zeros

d = vec\_cnttz(a)

Computes the count of trailing zero bits of each element of the input.

Each element of the result is set to the number of trailing zeros of the corresponding element of a.

Table 244. Vector Count Trailing Zeros

d	a
vector unsigned char	vector unsigned char
	vector signed char
vector unsigned short	vector unsigned short
	vector signed short
vector unsigned int	vector unsigned int
	vector signed int
vector unsigned long long	vector unsigned long long
	vector signed long long

### vec\_nor: Vector NOR

d = vec\_nor(a, b)

Performs a bitwise NOR of the given vectors a and b.

**Note:** This function will not cause IEEE exception on vector double.

Table 245. Vector NOR

d	a	b
vector bool char	vector bool char	vector bool char
vector signed char	vector bool char	vector signed char
	vector signed char	vector signed char
		vector bool char
vector unsigned char	vector bool char	vector unsigned char
	vector unsigned char	vector unsigned char
		vector bool char

Table 245. Vector NOR (continued)

d	a	b
vector bool short	vector bool short	vector vector bool short
vector signed short	vector bool short	vector signed short
	vector signed short	vector signed short
vector unsigned short	vector bool short	vector bool short
	vector unsigned short	vector unsigned short
vector bool int	vector bool int	vector bool int
vector signed int	vector bool int	vector signed int
	vector signed int	vector signed int
vector unsigned int	vector bool int	vector bool int
	vector unsigned int	vector unsigned int
vector bool long long	vector bool long long	vector bool long long
vector signed long long	vector bool long long	vector signed long long
	vector signed long long	vector signed long long
vector unsigned long long	vector bool long long	vector bool long long
	vector unsigned long long	vector unsigned long long
vector double	vector bool long long	vector bool long long
	vector double	vector double

## vec\_popcnt: Vector Population Count

d = vec\_popcnt(a)

Computes the population count (number of set bits) in each element of the input.

Each element of the result is set to the number of set bits in the corresponding element of the input.

**Note:** This function emulates the operation, except for vector signed char and vector unsigned char.

Table 246. Vector Population Count

d	a
vector unsigned char	vector signed char
	vector unsigned char
vector unsigned short	vector signed short
	vector unsigned short

Table 246. Vector Population Count (continued)

d	a
vector unsigned int	vector signed int
	vector unsigned int
vector unsigned long long	vector signed long long
	vector unsigned long long

## Merge

This section describes vector built-in functions for merging vectors.

### vec\_mergeh: Vector Merge High

`d = vec_mergeh(a, b)`

Merges the most significant ("high") halves of two vectors.

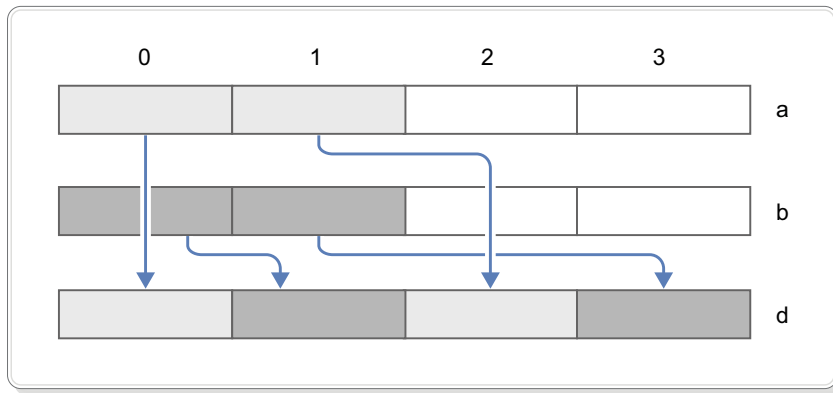

Figure 159. Merge 2 high-order elements (32-bit)

Assume that the elements of each vector are numbered beginning with 0. The even-numbered elements of the result are taken, in order, from the elements in the most significant half of a. The odd-numbered elements of the result are taken, in order, from the elements in the most significant half of b.

Table 247. Vector Merge High

d	a	b
vector bool char	vector bool char	vector bool char
vector signed char	vector signed char	vector signed char
vector unsigned char	vector unsigned char	vector unsigned char
vector bool short	vector bool short	vector bool short
vector signed short	vector signed short	vector signed short
vector unsigned short	vector unsigned short	vector unsigned short
vector bool int	vector bool int	vector bool int
vector signed int	vector signed int	vector signed int
vector unsigned int	vector unsigned int	vector unsigned int
vector bool long long	vector bool long long	vector bool long long
vector signed long long	vector signed long long	vector signed long long

Table 247. Vector Merge High (continued)

d	a	b
vector unsigned long long	vector unsigned long long	vector unsigned long long
vector double	vector double	vector double

### vec\_merge1: Vector Merge Low

`d = vec_merge1(a, b)`

Merges the least significant ("low") halves of two vectors.

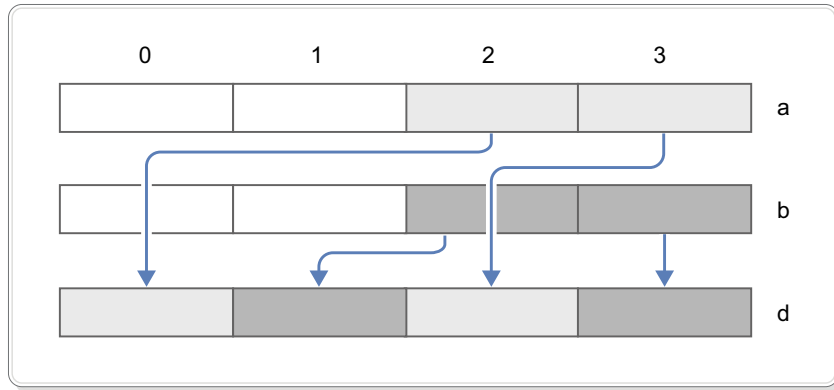

Figure 160. Merge 2 low-order elements (32-bit)

Assume that the elements of each vector are numbered beginning with 0. The even-numbered elements of the result are taken, in order, from the elements in the least significant half of a. The odd-numbered elements of the result are taken, in order, from the elements in the least significant half of b.

Table 248. Vector Merge Low

d	a	b
vector bool char	vector bool char	vector bool char
vector signed char	vector signed char	vector signed char
vector unsigned char	vector unsigned char	vector unsigned char
vector bool short	vector bool short	vector bool short
vector signed short	vector signed short	vector signed short
vector unsigned short	vector unsigned short	vector unsigned short
vector bool int	vector bool int	vector bool int
vector signed int	vector signed int	vector signed int
vector unsigned int	vector unsigned int	vector unsigned int
vector bool long long	vector bool long long	vector bool long long
vector signed long long	vector signed long long	vector signed long long
vector unsigned long long	vector unsigned long long	vector unsigned long long
vector double	vector double	vector double

## Pack and Unpack

This section describes vector built-in functions for pack and unpack.

## vec\_pack: Vector Pack

`d = vec_pack(a, b)`

The value of each element of the result vector is taken from the low-order half of the corresponding element of the result of concatenating a and b.

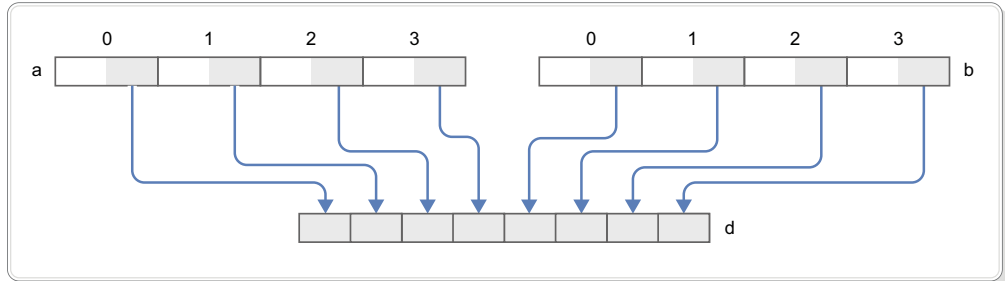

Figure 161. Pack 8 integer elements (32-bit) to 8 integer elements (16-bit)

Table 249. Vector Pack

d	a	b
vector signed char	vector signed short	vector signed short
vector bool char	vector bool short	vector bool short
vector unsigned char	vector unsigned short	vector unsigned short
vector signed short	vector signed int	vector signed int
vector bool short	vector bool int	vector bool int
vector unsigned short	vector unsigned int	vector unsigned int
vector signed int	vector signed long long	vector signed long long
vector bool int	vector bool long long	vector bool long long
vector unsigned int	vector unsigned long long	vector unsigned long long

## vec\_packs: Vector Pack Saturate

`d = vec_packs(a, b)`

The value of each element of the result vector is the saturated value of the corresponding element of the result of concatenating a and b.

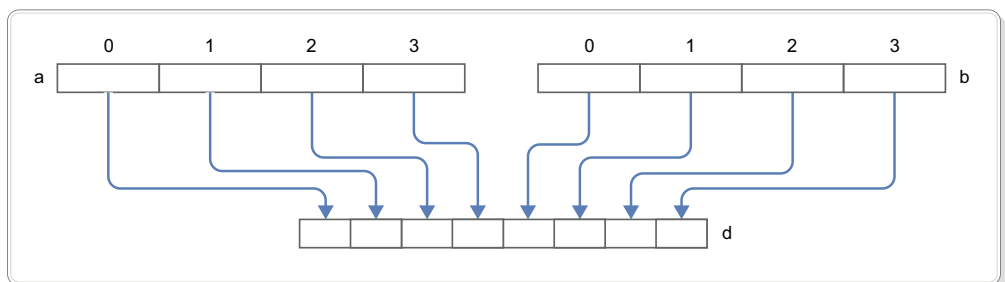

Figure 162. Pack 8 integer elements (32-bit) to 8 integer elements (16-bit)

Table 250. Vector Pack Saturate

d	a	b
vector signed char	vector signed short	vector signed short
vector unsigned char	vector unsigned short	vector unsigned short
vector signed short	vector signed int	vector signed int
vector unsigned short	vector unsigned int	vector unsigned int
vector signed int	vector signed long long	vector signed long long
vector unsigned int	vector unsigned long long	vector unsigned long long

### vec\_packs\_cc: Vector Pack Saturate Condition Code

d = vec\_packs\_cc(a, b, c)

The value of each element of the result vector is the saturated value of the corresponding element of the result of concatenating a and b. The resulting condition code is returned through parameter c. For the signed types, the resulting condition code is from the VECTOR PACK SATURATE (VPKS) instruction. For the unsigned types, the resulting condition code is from the VECTOR PACK LOGICAL SATURATE (VPKLS) instruction.

Table 251. Vector Pack Saturate Condition Code

d	a	b	c
vector signed char	vector signed short	vector signed short	int *
vector unsigned char	vector unsigned short	vector unsigned short	
vector signed short	vector signed int	vector signed int	
vector unsigned short	vector unsigned int	vector unsigned int	
vector signed int	vector signed long long	vector signed long long	
vector unsigned int	vector unsigned long long	vector unsigned long long	

### vec\_packsu: Vector Pack Saturated Unsigned

d = vec\_packsu(a, b)

The value of each element of the result vector is the saturated unsigned value of the corresponding element of the result of concatenating a and b.

Table 252. Vector Pack Saturated Unsigned

d	a	b
vector unsigned char	vector signed short	vector signed short
	vector unsigned short	vector unsigned short
vector unsigned short	vector signed int	vector signed int
	vector unsigned int	vector unsigned int
vector unsigned int	vector signed long long	vector signed long long
	vector unsigned long long	vector unsigned long long

### vec\_packsu\_cc: Vector Pack Saturated Unsigned Condition Code

d = vec\_packsu\_cc(a, b, c)

The value of each element of the result vector is the saturated unsigned value of the corresponding element of the result of concatenating a and b. The resulting condition code from the VECTOR PACK LOGICAL SATURATE (VPKLS) instruction is returned through parameter c.

Table 253. Vector Pack Saturated Unsigned Condition Code

d	a	b	c
vector unsigned char	vector unsigned short	vector unsigned short	int *
vector unsigned short	vector unsigned int	vector unsigned int	
vector unsigned int	vector unsigned long long	vector unsigned long long	

### vec\_unpackh: Vector Unpack High Element

d = vec\_unpackh(a)

Unpacks the most significant ("high") half of a vector into a vector with larger elements. The value of each element of the result is the value of the corresponding element of the most significant half of a.

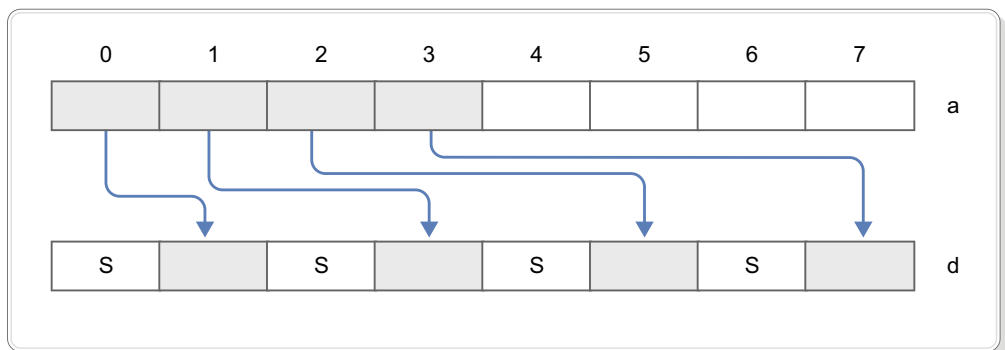

Figure 163. Unpack high-order integer elements (16-bit) to integer elements (32-bit)

Table 254. Vector Unpack High Element

d	a
vector signed short	vector signed char
vector bool short	vector bool char
vector signed int	vector signed short
vector bool int	vector bool short
vector signed long long	vector signed int
vector bool long long	vector bool int
vector unsigned short	vector unsigned char
vector unsigned int	vector unsigned short
vector unsigned long long	vector unsigned int

### vec\_unpackl: Vector Unpack Low Element

d = vec\_unpackl(a)

Unpacks the least significant ("low") half of a vector into a vector with larger elements. The value of each element of the result is the value of the corresponding

element of the least significant half of a.

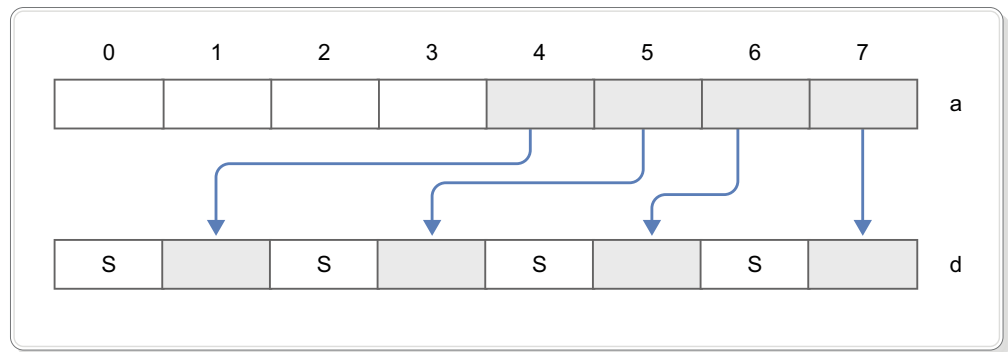

Figure 164. Unpack low-order integer elements (16-bit) to integer elements (32-bit)

Table 255. Vector Unpack Low Element

d	a
vector signed short	vector signed char
vector bool short	vector bool char
vector signed int	vector signed short
vector bool int	vector bool short
vector signed long long	vector signed int
vector bool long long	vector bool int
vector unsigned short	vector unsigned char
vector unsigned int	vector unsigned short
vector unsigned long long	vector unsigned int

## Replicate

This section describes vector built-in functions for replicating vector elements.

### vec\_splat: Vector Splat

`d = vec_splat(a, b)`

Returns a vector that has all of its elements set to a given value. The value of each element of the result is the value of the element of a specified by b.

Table 256. Vector Splat

d	a	b
vector bool char	vector bool char	0 - 15
vector signed char	vector signed char	
vector unsigned char	vector unsigned char	
vector bool short	vector bool short	0 - 7
vector signed short	vector signed short	
vector unsigned short	vector unsigned short	
vector bool int	vector bool int	0 - 3
vector signed int	vector signed int	
vector unsigned int	vector unsigned int	



Table 256. Vector Splat (continued)

d	a	b
vector bool long long	vector bool long long	0 - 1
vector signed long long	vector signed long long	
vector unsigned long long	vector unsigned long long	
vector double	vector double	

### vec\_splat\_s8: Vector Splat Signed Byte

d = vec\_splat\_s8(a)

Returns a vector with each of the 16 signed 8-bits element equal to the given value.

Table 257. Vector Splat Signed Byte

d	a
vector signed char	-128 - 127

### vec\_splat\_s16: Vector Splat Signed Halfword

d = vec\_splat\_s16(a)

Returns a vector with each of the 8 signed 16-bits element equal to the given value.

Table 258. Vector Splat Signed Halfword

d	a
vector signed short	$-2^{15} - 2^{15}-1$

### vec\_splat\_s32: Vector Splat Signed Word

d = vec\_splat\_s32(a)

Returns a vector with each of the 4 signed 32-bits element equal to the given value.

Table 259. Vector Splat Signed Word

d	a
vector signed int	$-2^{15} - 2^{15}-1$

### vec\_splat\_s64: Vector Splat Signed Doubleword

d = vec\_splat\_s64(a)

Returns a vector with each of the 2 signed 64-bits element equal to the given value.

Table 260. Vector Splat Signed Doubleword

d	a
vector signed long long	$-2^{15} - 2^{15}-1$

### vec\_splat\_u8: Vector Splat Unsigned Byte

d = vec\_splat\_u8(a)

Returns a vector with each of the 16 unsigned 8-bits element equal to the given value.

Table 261. Vector Splat Unsigned Byte

d	a
vector unsigned char	0 - 255

### vec\_splat\_u16: Vector Splat Unsigned Halfword

d = vec\_splat\_u16(a)

Returns a vector with each of the 8 unsigned 16-bits element equal to the given value.

Table 262. Vector Splat Unsigned Halfword

d	a
vector unsigned short	0 - $2^{16}-1$

### vec\_splat\_u32: Vector Splat Unsigned Word

d = vec\_splat\_u32(a)

Returns a vector with each of the 4 unsigned 32-bits element equal to the given value.

Table 263. Vector Splat Unsigned Word

d	a
vector unsigned int	$-2^{15} - 2^{15}-1$

### vec\_splat\_u64: Vector Splat Unsigned Doubleword

d = vec\_splat\_u64(a)

Returns a vector with each of the 2 unsigned 64-bits element equal to the given value.

Table 264. Vector Splat Doubleword

d	a
vector unsigned long long	$-2^{15} - 2^{15}-1$

### vec\_splats: Vector Splats

d = vec\_splats(a)

Returns a vector of which the value of each element is set to a.

Table 265. Vector Splats

d	a
vector signed char	signed char
vector unsigned char	unsigned char
vector signed short	signed short
vector unsigned short	unsigned short
vector signed int	signed int
vector unsigned int	unsigned int
vector signed long long	signed long long

Table 265. Vector Splats (continued)

d	a
vector unsigned long long	unsigned long long
vector double	double

## Rotate and Shift

This section describes vector built-in functions for rotate and shift.

### vec\_rl: Vector Element Rotate Left

$d = \text{vec\_rl}(a, b)$

Rotates each element of a vector left by a given number of bits. Each element of the result is obtained by rotating the corresponding element of a left by the number of bits specified by the corresponding element of *b*, modulo the number of bits in the element.

Table 266. Vector Element Rotate Left

d	a	b
vector unsigned char	vector unsigned char	vector unsigned char
vector signed char	vector signed char	
vector unsigned short	vector unsigned short	vector unsigned short
vector signed short	vector signed short	
vector unsigned int	vector unsigned int	vector unsigned int
vector signed int	vector signed int	
vector unsigned long long	vector unsigned long long	vector unsigned long long
vector signed long long	vector signed long long	

### vec\_rl\_mask: Vector Element Rotate and Insert Under Mask

$d = \text{vec\_rl\_mask}(a, b, c)$

Rotates each element of vector *a* left by a given number of bits *c*, modulo the number of bits in the element, and overlay with the original vector *a* depends on the mask *b*. Each bit of the result is obtained where if the corresponding bit the mask *b* is 1, it will get the corresponding bit from the intermediate result. Otherwise, if the corresponding bit the mask *b* is 0, it will get the corresponding bit from *a*, before the rotation.

Table 267. Vector Element Rotate and Insert Under Mask

d	a	b	c
vector unsigned char	vector unsigned char	vector unsigned char	unsigned char literal 0 - 255
vector signed char	vector signed char	vector unsigned char	
vector unsigned short	vector unsigned short	vector unsigned short	
vector signed short	vector signed short	vector unsigned short	
vector unsigned int	vector unsigned int	vector unsigned int	
vector signed int	vector signed int	vector unsigned int	
vector unsigned long long	vector unsigned long long	vector unsigned long long	
vector signed long long	vector signed long long	vector unsigned long long	

### vec\_rli: Vector Element Rotate Left Immediate

$d = \text{vec\_rli}(a, b)$

Rotates each element of a vector left by a given number of bits. Each element of the result is obtained by rotating the corresponding element of a left by the number of bits specified by *b*, modulo the number of bits in the element.

Table 268. Vector Element Rotate Left Immediate

d	a	b
vector unsigned char	vector unsigned char	unsigned long
vector signed char	vector signed char	
vector unsigned short	vector unsigned short	unsigned long
vector signed short	vector signed short	
vector unsigned int	vector unsigned int	unsigned long
vector signed int	vector signed int	
vector unsigned long long	vector unsigned long long	unsigned long
vector signed long long	vector signed long long	

### vec\_slb: Vector Shift Left by Byte

$d = \text{vec\_slb}(a, b)$

Performs a left shift for a vector by a given number of bytes. Each element of the result is obtained by shifting the corresponding element of a left by the number of bytes specified by bits 1-4 of byte element seven of *b*. The bits that are shifted out are replaced by zeros.

Table 269. Vector Shift Left by Byte

d	a	b
vector unsigned char	vector unsigned char	vector unsigned char
		vector signed char
vector signed char	vector signed char	vector unsigned char
		vector signed char
vector unsigned short	vector unsigned short	vector unsigned short
		vector signed short

Table 269. Vector Shift Left by Byte (continued)

d	a	b
vector signed short	vector signed short	vector unsigned short
		vector signed short
vector unsigned int	vector unsigned int	vector unsigned int
		vector signed int
vector signed int	vector signed int	vector unsigned int
		vector signed int
vector unsigned long long	vector unsigned long long	vector unsigned long long
		vector signed long long
vector signed long long	vector signed long long	vector unsigned long long
		vector signed long long
vector double	vector double	vector signed long long
		vector unsigned long long

### vec\_sld: Vector Shift Left Double by Byte

`d = vec_sld(a, b, c)`

Performs a left shift for two concatenated vectors by a given number of bytes. The result is the most significant 16 bytes obtained by concatenating a and b, and shifting left by the number of bytes specified by c.

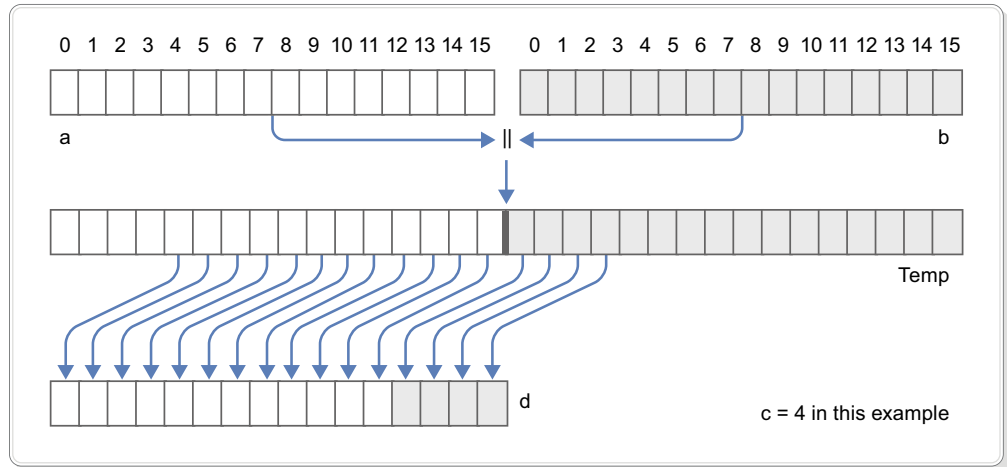

Figure 165. Bit-wise conditional select of vector contents (128-bit)

Table 270. Vector Shift Left Double by Byte

d	a	b	c
vector unsigned char	vector unsigned char	vector unsigned char	0 - 15
vector signed char	vector signed char	vector signed char	
vector unsigned short	vector unsigned short	vector unsigned short	
vector signed short	vector signed short	vector signed short	
vector unsigned int	vector unsigned int	vector unsigned int	
vector signed int	vector signed int	vector signed int	
vector unsigned long long	vector unsigned long long	vector unsigned long long	
vector signed long long	vector signed long long	vector signed long long	
vector double	vector double	vector double	

### vec\_sldw: Vector Shift Left Double by Word

d = vec\_sldw(a, b, c)

Returns a vector by concatenating a and b, and then left shifts the result vector by multiples of 4 bytes. c specifies the offset for the shifting operation. After left-shifting the concatenated a and b by multiples of 4 bytes specified by c, the function takes the four leftmost 4-byte values and forms the result vector.

Table 271. Vector Shift Left Double by Word

d	a	b	c
vector unsigned char	vector unsigned char	vector unsigned char	0 - 3
vector signed char	vector signed char	vector signed char	
vector unsigned short	vector unsigned short	vector unsigned short	
vector signed short	vector signed short	vector signed short	
vector unsigned int	vector unsigned int	vector unsigned int	
vector signed int	vector signed int	vector signed int	
vector unsigned long long	vector unsigned long long	vector unsigned long long	
vector signed long long	vector signed long long	vector signed long long	
vector double	vector double	vector double	

### vec\_sll: Vector Shift Left

d = vec\_sll(a, b)

Performs a left shift for a vector by a given number of bits. Each element of the result is obtained by shifting the corresponding element of a left by the number of bits specified by the last 3 bits of every byte of b. The bits that are shifted out are replaced by zeros.

**Note:** The low-order 3 bits of all byte elements in b must be the same, otherwise the result is undefined.

Table 272. Vector Shift Left

d	a	b
vector unsigned char	vector unsigned char	vector unsigned char
		vector unsigned short
		vector unsigned int
vector signed char	vector signed char	vector unsigned char
		vector unsigned short
		vector unsigned int
vector bool char	vector bool char	vector unsigned char
		vector unsigned short
		vector unsigned int
vector unsigned short	vector unsigned short	vector unsigned char
		vector unsigned short
		vector unsigned int
vector signed short	vector signed short	vector unsigned char
		vector unsigned short
		vector unsigned int
vector bool short	vector bool short	vector unsigned char
		vector unsigned short
		vector unsigned int
vector unsigned int	vector unsigned int	vector unsigned char
		vector unsigned short
		vector unsigned int
vector signed int	vector signed int	vector unsigned char
		vector unsigned short
		vector unsigned int
vector bool int	vector bool int	vector unsigned char
		vector unsigned short
		vector unsigned int
vector unsigned long long	vector unsigned long long	vector unsigned char
		vector unsigned short
		vector unsigned int
vector signed long long	vector signed long long	vector unsigned char
		vector unsigned short
		vector unsigned int
vector bool long long	vector bool long long	vector unsigned char
		vector unsigned short
		vector unsigned int

**vec\_srab: Vector Shift Right Arithmetic by Byte**

d = vec\_srab(a, b)

Performs an algebraic right shift for a vector by a given number of bytes. Each element of the result is obtained by shifting the corresponding element of a right by the number of bytes specified by bits 1-4 of byte element seven of b. The bits that are shifted out are replaced by copies of the most significant bit of the element of a.

Table 273. Vector Shift Right Arithmetic by Byte

d	a	b
vector unsigned char	vector unsigned char	vector unsigned char
		vector signed char
vector signed char	vector signed char	vector unsigned char
		vector signed char
vector unsigned short	vector unsigned short	vector unsigned short
		vector signed short
vector signed short	vector signed short	vector unsigned short
		vector signed short
vector unsigned int	vector unsigned int	vector unsigned int
		vector signed int
vector signed int	vector signed int	vector unsigned int
		vector signed int
vector unsigned long long	vector unsigned long long	vector unsigned long long
		vector signed long long
vector signed long long	vector signed long long	vector unsigned long long
		vector signed long long
vector double	vector double	vector unsigned long long
		vector signed long long

### vec\_sral: Vector Shift Right Arithmetic

$d = \text{vec\_sral}(a, b)$

Performs an algebraic right shift for a vector by a given number of bits. Each element of the result is obtained by shifting the corresponding element of a right by the number of bits specified by the last 3 bits of every byte of b. The bits that are shifted out are replaced by copies of the most significant bit of the element of a.

**Note:** The low-order 3 bits of all byte elements in b must be the same, otherwise the result is undefined.

Table 274. Vector Shift Right Arithmetic

d	a	b
vector unsigned char	vector unsigned char	vector unsigned char
		vector unsigned short
		vector unsigned int
vector signed char	vector signed char	vector unsigned char
		vector unsigned short
		vector unsigned int



Table 274. Vector Shift Right Arithmetic (continued)

d	a	b
vector bool char	vector bool char	vector unsigned char
		vector unsigned short
		vector unsigned int
vector unsigned short	vector unsigned short	vector unsigned char
		vector unsigned short
		vector unsigned int
vector signed short	vector signed short	vector unsigned char
		vector unsigned short
		vector unsigned int
vector bool short	vector bool short	vector unsigned char
		vector unsigned short
		vector unsigned int
vector unsigned int	vector unsigned int	vector unsigned char
		vector unsigned short
		vector unsigned int
vector signed int	vector signed int	vector unsigned char
		vector unsigned short
		vector unsigned int
vector bool int	vector bool int	vector unsigned char
		vector unsigned short
		vector unsigned int
vector unsigned long long	vector unsigned long long	vector unsigned char
		vector unsigned short
		vector unsigned int
vector signed long long	vector signed long long	vector unsigned char
		vector unsigned short
		vector unsigned int
vector bool long long	vector bool long long	vector unsigned char
		vector unsigned short
		vector unsigned int

### **vec\_srb: Vector Shift Right by Byte**

`d = vec_srb(a, b)`

Performs a right shift for a vector by a given number of bytes. Each element of the result is obtained by shifting the corresponding element of a right by the number of bytes specified by bits 1-4 of byte element seven of `b`. The bits that are shifted out are replaced by zeros.

Table 275. Vector Shift Right by Byte

d	a	b
vector unsigned char	vector unsigned char	vector unsigned char
		vector signed char
vector signed char	vector signed char	vector unsigned char
		vector signed char
vector unsigned short	vector unsigned short	vector unsigned short
		vector signed short
vector signed short	vector signed short	vector unsigned short
		vector signed short
vector unsigned int	vector unsigned int	vector unsigned int
		vector signed int
vector signed int	vector signed int	vector unsigned int
		vector signed int
vector unsigned long long	vector unsigned long long	vector unsigned long long
		vector signed long long
vector signed long long	vector signed long long	vector unsigned long long
		vector signed long long
vector double	vector double	vector unsigned long long
		vector signed long long

### vec\_srl: Vector Shift Right

$d = \text{vec\_srl}(a, b)$

Performs a right shift for a vector by a given number of bits. Each element of the result is obtained by shifting the corresponding element of a right by the number of bits specified by the last 3 bits of every byte of b. The bits that are shifted out are replaced by zeros.

**Note:** The low-order 3 bits of all byte elements in b must be the same, otherwise the result is undefined.

Table 276. Vector Shift Right

d	a	b
vector unsigned char	vector unsigned char	vector unsigned char
		vector unsigned short
		vector unsigned int
vector signed char	vector unsigned char	vector unsigned char
		vector unsigned short
		vector unsigned int
vector bool char	vector bool char	vector unsigned char
		vector unsigned short
		vector unsigned int

Table 276. Vector Shift Right (continued)

d	a	b
vector unsigned short	vector unsigned short	vector unsigned char
		vector unsigned short
		vector unsigned int
vector signed short	vector signed short	vector unsigned char
		vector unsigned short
		vector unsigned int
vector bool short	vector bool short	vector unsigned char
		vector unsigned short
		vector unsigned int
vector unsigned int	vector unsigned int	vector unsigned char
		vector unsigned short
		vector unsigned int
vector signed int	vector signed int	vector unsigned char
		vector unsigned short
		vector unsigned int
vector bool int	vector bool int	vector unsigned char
		vector unsigned short
		vector unsigned int
vector unsigned long long	vector unsigned long long	vector unsigned char
		vector unsigned short
		vector unsigned int
vector signed long long	vector signed long long	vector unsigned char
		vector unsigned short
		vector unsigned int
vector bool long long	vector bool long long	vector unsigned char
		vector unsigned short
		vector unsigned int

## Rounding and Conversion

This section describes vector built-in functions for rounding and conversion.

### **vec\_ceil: Vector Ceiling**

`d = vec_ceil(a)`

Returns a vector containing the smallest representable floating-point integral values greater than or equal to the values of the corresponding elements of the given vector.

**Note:** `vec_ceil` provides the same functionality as `vec_roundp`, except that `vec_ceil` could trigger the IEEE-inexact exception.

Table 277. Vector Ceiling

d	a
vector double	vector double

### vec\_ctd: Vector Convert to Double

$d = \text{vec\_ctd}(a, b)$

Converts the type of each element in a from integer to floating-point double precision and divides the result by 2 to the power of b.

**Note:** Current BFP rounding mode is used on the conversion.

Table 278. Vector Convert to Double

d	a	b
vector double	vector signed long long	0 - 31
	vector unsigned long long	

### vec\_ctsl: Vector Convert to signed long long

$d = \text{vec\_ctsl}(a, b)$

Multiplies each element in a by 2 to the power of b and rounds the result toward 0 into an integer.

Table 279. Vector Convert to signed long long

d	a	b
vector signed long long	vector double	0 - 31

### vec\_ctul: Vector Convert to unsigned long long

$d = \text{vec\_ctul}(a, b)$

Multiplies each element in a by 2 to the power of b and rounds the result toward 0 into an unsigned integer.

Table 280. Vector Convert to unsigned long long

d	a	b
vector unsigned long long	vector double	0 - 31

### vec\_extend\_s64: Vector Sign Extend to Doubleword

$d = \text{vec\_extend\_s64}(a)$

Returns a vector with sign-extended on the rightmost element-sized sub-element of each doubleword.

Table 281. Extend Sign to Doubleword

d	a
vector signed long long	vector signed char
vector signed long long	vector signed short
vector signed long long	vector signed int

## **vec\_floor: Vector Floor**

`d = vec_floor(a)`

Returns a vector containing the largest representable floating-point integral values less than or equal to the values of the corresponding elements of the given vector.

**Note:** `vec_floor` provides the same functionality as `vec_roundm`, except that `vec_floor` could trigger the IEEE-inexact exception.

*Table 282. Vector Floor*

<b>d</b>	<b>a</b>
vector double	vector double

## **vec\_round: Vector Round to Nearest**

`d = vec_round(a)`

Returns a vector containing the rounded values to the nearest representable floating-point integer, using IEEE round-to-nearest rounding, of the corresponding elements of the given vector.

**Note:** IEEE-inexact exception is suppressed.

*Table 283. Vector Round to Nearest*

<b>d</b>	<b>a</b>
vector double	vector double

## **vec\_roundc: Vector Round to Current**

`d = vec_roundc(a)`

Returns a vector by using the current rounding mode to round every double-precision floating-point element in the given vector to integer.

**Note:** IEEE-inexact exception is suppressed.

*Table 284. Vector Round to Current*

<b>d</b>	<b>a</b>
vector double	vector double

## **vec\_roundm: Vector Round toward Negative Infinity**

`d = vec_roundm(a)`

Returns a vector containing the largest representable floating-point integral values less than or equal to the values of the corresponding elements of the given vector.

**Note:** `vec_roundm` provides the same functionality as `vec_floor`, except that `vec_roundm` would not trigger the IEEE-inexact exception.

*Table 285. Vector Round toward Negative Infinity*

<b>d</b>	<b>a</b>
vector double	vector double

### **vec\_roundp: Vector Round toward Positive Infinity**

`d = vec_roundp(a)`

Returns a vector containing the smallest representable floating-point integral values greater than or equal to the values of the corresponding elements of the given vector.

**Note:** `vec_roundp` provides the same functionality as `vec_ceil`, except that `vec_roundp` would not trigger the IEEE-inexact exception.

*Table 286. Vector Round toward Positive Infinity*

<b>d</b>	<b>a</b>
vector double	vector double

### **vec\_roundz: Vector Round toward Zero**

`d = vec_roundz(a)`

Returns a vector containing the truncated values of the corresponding elements of the given vector. Each element of the result contains the value of the corresponding element of `a`, truncated to an integral value.

**Note:** `vec_roundz` provides the same functionality as `vec_trunc`, except that `vec_roundz` would not trigger the IEEE-inexact exception.

*Table 287. Vector Round toward Zero*

<b>d</b>	<b>a</b>
vector double	vector double

### **vec\_trunc: Vector Truncate**

`d = vec_trunc(a)`

Returns a vector containing the truncated values of the corresponding elements of the given vector. Each element of the result contains the value of the corresponding element of `a`, truncated to an integral value.

**Note:** `vec_trunc` provides the same functionality as `vec_roundz`, except that `vec_trunc` could trigger the IEEE-inexact exception.

*Table 288. Vector Truncate*

<b>d</b>	<b>a</b>
vector double	vector double

## **Test**

This section describes vector built-in functions for testing.

### **vec\_fp\_test\_data\_class: Vector Floating-Point Test Data Class**

`d = vec_fp_test_data_class (a, b, c)`

Performs a test of the BFP element class on the vector element `a`, based on the specified condition `b`, using the VECTOR FP TEST DATA CLASS IMMEDIATE (VFTCIDB) instruction. The condition code set by the VFTCIDB instruction is returned through `c`.

d represents the first operand in the instruction.

a represents the second operand in the instruction.

b represents the third operand in the instruction.

Table 289. Vector Floating-Point Test Data Class

d	a	b	c
vector bool long long	vector double	0 - 4095	int *

### vec\_test\_mask: Vector Test under Mask

d = vec\_test\_mask(a, b)

Returns the condition code set by the Vector Test Under Mask (VTM) instruction. a is the first operand, and b is the second operand on the instruction.

Table 290. Vector Test under Mask

d	a	b
int	vector signed char	vector unsigned char
	vector unsigned char	
	vector signed short	vector unsigned short
	vector unsigned short	
	vector signed int	vector unsigned int
	vector unsigned int	
	vector signed long long	vector unsigned long long
	vector unsigned long long	
	vector double	vector unsigned long long

## All Predicates

This section describes vector built-in functions for searching and comparing all elements.

### vec\_all\_eq: All Elements Equal

d = vec\_all\_eq(a, b)

Tests whether all sets of corresponding elements of the given vectors are equal. The result is 1 if each element of a is equal to the corresponding element of b. Otherwise, the result is 0.

Table 291. All Elements Equal

d	a	b
int	vector bool char	vector bool char
		vector signed char
		vector unsigned char
	vector signed char	vector bool char
		vector signed char
	vector unsigned char	vector bool char
		vector unsigned char
	vector bool short	vector bool short
		vector signed short
		vector unsigned short
	vector signed short	vector bool short
		vector signed short
	vector unsigned short	vector bool short
		vector unsigned short
	vector bool int	vector bool int
		vector signed int
		vector unsigned int
	vector signed int	vector bool int
		vector signed int
	vector unsigned int	vector bool int
		vector unsigned int
	vector bool long long	vector bool long long
		vector signed long long
		vector unsigned long long
	vector signed long long	vector bool long long
		vector signed long long
	vector unsigned long long	vector bool long long
		vector unsigned long long
	vector double	vector double

### **vec\_all\_ge: All Elements Greater Than or Equal**

`d = vec_all_ge(a, b)`

Tests whether all elements of the first argument are greater than or equal to the corresponding elements of the second argument. The result is 1 if all elements of a are greater than or equal to the corresponding elements of b. Otherwise, the result is 0.



Table 292. All Elements Greater Than or Equal

d	a	b
int	vector signed char	vector signed char
		vector bool char
	vector bool char	vector bool char
		vector signed char
		vector unsigned char
	vector unsigned char	vector unsigned char
		vector bool char
	vector signed short	vector signed short
		vector bool short
	vector bool short	vector bool short
		vector signed short
		vector unsigned short
	vector unsigned short	vector unsigned short
		vector bool short
	vector signed int	vector signed int
		vector bool int
	vector bool int	vector bool int
		vector signed int
		vector unsigned int
	vector unsigned int	vector unsigned int
		vector bool int
	vector signed long long	vector signed long long
		vector bool long long
	vector bool long long	vector bool long long
		vector signed long long
		vector unsigned long long
	vector unsigned long long	vector unsigned long long
		vector bool long long
	vector double	vector double

### **vec\_all\_gt: All Elements Greater Than**

`d = vec_all_gt(a, b)`

Tests whether all elements of the first argument are greater than the corresponding elements of the second argument. The result is 1 if all elements of a are greater than the corresponding elements of b. Otherwise, the result is 0.

Table 293. All Elements Greater Than

d	a	b
int	vector signed char	vector signed char
		vector bool char
	vector bool char	vector bool char
		vector signed char
		vector unsigned char
	vector unsigned char	vector unsigned char
		vector bool char
	vector signed short	vector signed short
		vector bool short
	vector bool short	vector bool short
		vector signed short
		vector unsigned short
	vector unsigned short	vector unsigned short
		vector bool short
	vector signed int	vector signed int
		vector bool int
	vector bool int	vector bool int
		vector signed int
		vector unsigned int
	vector unsigned int	vector unsigned int
		vector bool int
	vector signed long long	vector signed long long
		vector bool long long
	vector bool long long	vector bool long long
		vector signed long long
		vector unsigned long long
	vector unsigned long long	vector unsigned long long
		vector bool long long
	vector double	vector double

### **vec\_all\_le: All Elements Less Than or Equal**

`d = vec_all_le(a, b)`

Tests whether all elements of the first argument are less than or equal to the corresponding elements of the second argument. The result is 1 if all elements of a are less than or equal to the corresponding elements of b. Otherwise, the result is 0.

Table 294. All Elements Less Than or Equal

d	a	b
int	vector signed char	vector signed char
		vector bool char
	vector bool char	vector bool char
		vector signed char
		vector unsigned char
	vector unsigned char	vector unsigned char
		vector bool char
	vector signed short	vector signed short
		vector bool short
	vector bool short	vector bool short
		vector signed short
		vector unsigned short
	vector unsigned short	vector unsigned short
		vector bool short
	vector signed int	vector signed int
		vector bool int
	vector bool int	vector bool int
		vector signed int
		vector unsigned int
	vector unsigned int	vector unsigned int
		vector bool int
	vector signed long long	vector signed long long
		vector bool long long
	vector bool long long	vector bool long long
		vector signed long long
		vector unsigned long long
	vector unsigned long long	vector unsigned long long
		vector bool long long
	vector double	vector double

### vec\_all\_lt: All Elements Less Than

`d = vec_all_lt(a, b)`

Tests whether all elements of the first argument are less than the corresponding elements of the second argument. The result is 1 if all elements of a are less than the corresponding elements of b. Otherwise, the result is 0.

Table 295. All Elements Less Than

d	a	b
int	vector signed char	vector signed char
		vector bool char
	vector bool char	vector bool char
		vector signed char
		vector unsigned char
	vector unsigned char	vector unsigned char
		vector bool char
	vector signed short	vector signed short
		vector bool short
	vector bool short	vector bool short
		vector signed short
		vector unsigned short
	vector unsigned short	vector unsigned short
		vector bool short
	vector signed int	vector signed int
		vector bool int
	vector bool int	vector bool int
		vector signed int
		vector unsigned int
	vector unsigned int	vector unsigned int
		vector bool int
	vector signed long long	vector signed long long
		vector bool long long
	vector bool long long	vector bool long long
		vector signed long long
		vector unsigned long long
	vector unsigned long long	vector unsigned long long
		vector bool long long
vector double	vector double	

### vec\_all\_nan: All Elements Not a Number

d = vec\_all\_nan(a)

Tests whether each element of the given vector is a NaN. The result is 1 if each element of a is a NaN. Otherwise, the result is 0.

Table 296. All Elements Not a Number

d	a
int	vector double

### vec\_all\_ne: All Elements Not Equal

d = vec\_all\_ne(a, b)

Tests whether all sets of corresponding elements of the given vectors are not equal. The result is 1 if each element of a is not equal to the corresponding element of b. Otherwise, the result is 0.

Table 297. All Elements Not Equal

d	a	b
int	vector bool char	vector signed char
		vector bool char
		vector unsigned char
	vector signed char	vector bool char
		vector signed char
	vector unsigned char	vector bool char
		vector unsigned char
	vector bool short	vector signed short
		vector bool short
		vector unsigned short
	vector signed short	vector bool short
		vector signed short
	vector unsigned short	vector bool short
		vector unsigned short
	vector bool int	vector signed int
		vector bool int
		vector unsigned int
	vector signed int	vector bool int
		vector signed int
	vector unsigned int	vector bool int
		vector unsigned int
	vector bool long long	vector signed long long
		vector bool long long
		vector unsigned long long
	vector signed long long	vector bool long long
		vector signed long long
	vector unsigned long long	vector bool long long
		vector unsigned long long
	vector double	vector double

### vec\_all\_nge: All Elements Not Greater Than or Equal

d = vec\_all\_nge(a, b)

Tests whether each element of the first argument is not greater than or equal to the corresponding element of the second argument. The result is 1 if each element of a is not greater than or equal to the corresponding element of b. Otherwise, the result is 0.

Table 298. All Elements Not Greater Than or Equal

<b>d</b>	<b>a</b>	<b>b</b>
int	vector double	vector double

### **vec\_all\_ngt: All Elements Not Greater Than**

`d = vec_all_ngt(a, b)`

Tests whether each element of the first argument is not greater than the corresponding element of the second argument. The result is 1 if each element of a is not greater than the corresponding element of b. Otherwise, the result is 0.

Table 299. All Elements Not Greater Than

<b>d</b>	<b>a</b>	<b>b</b>
int	vector double	vector double

### **vec\_all\_nle: All Elements Not Less Than or Equal**

`d = vec_all_nle(a, b)`

Tests whether each element of the first argument is not less than or equal to the corresponding element of the second argument. The result is 1 if each element of a is not less than or equal to the corresponding element of b. Otherwise, the result is 0.

Table 300. All Elements Not Less Than or Equal

<b>d</b>	<b>a</b>	<b>b</b>
int	vector double	vector double

### **vec\_all\_nlt: All Elements Not Less Than**

`d = vec_all_nlt(a, b)`

Tests whether each element of the first argument is not less than the corresponding element of the second argument. The result is 1 if each element of a is not less than the corresponding element of b. Otherwise, the result is 0.

Table 301. All Elements Not Less Than

<b>d</b>	<b>a</b>	<b>b</b>
int	vector double	vector double

### **vec\_all\_numeric: All Elements Numeric**

`d = vec_all_numeric(a)`

Tests whether each element of the given vector is numeric (not a NaN). The result is 1 if each element of a is numeric (not a NaN). Otherwise, the result is 0.

Table 302. All Elements Numeric

<b>d</b>	<b>a</b>
int	vector double

## Any Predicates

This section describes vector built-in functions for searching and comparing any elements.

### **vec\_any\_eq: Any Element Equal**

`d = vec_any_eq(a, b)`

Tests whether any set of corresponding elements of the given vectors are equal. The result is 1 if any element of a is equal to the corresponding element of b. Otherwise, the result is 0.

*Table 303. Any Element Equal*

d	a	b
int	vector bool char	vector bool char
		vector signed char
		vector unsigned char
	vector signed char	vector bool char
		vector signed char
	vector unsigned char	vector bool char
		vector unsigned char
	vector bool short	vector bool short
		vector signed short
		vector unsigned short
	vector signed short	vector bool short
		vector signed short
	vector unsigned short	vector bool short
		vector unsigned short
	vector bool int	vector bool int
		vector signed int
		vector unsigned int
	vector signed int	vector bool int
		vector signed int
	vector unsigned int	vector bool int
		vector unsigned int
	vector bool long long	vector bool long long
		vector signed long long
		vector unsigned long long
	vector signed long long	vector bool long long
		vector signed long long
	vector unsigned long long	vector bool long long
		vector unsigned long long
	vector double	vector double

### **vec\_any\_ge: Any Element Greater Than or Equal**

`d = vec_any_ge(a, b)`

Tests whether any element of the first argument is greater than or equal to the corresponding element of the second argument. The result is 1 if any element of a is greater than or equal to the corresponding element of b. Otherwise, the result is 0.

*Table 304. Any Element Greater Than or Equal*

<b>d</b>	<b>a</b>	<b>b</b>
int	vector signed char	vector signed char
		vector bool char
	vector bool char	vector signed char
		vector unsigned char
	vector unsigned char	vector unsigned char
		vector bool char
	vector signed short	vector signed short
		vector bool short
	vector bool short	vector signed short
		vector unsigned short
	vector unsigned short	vector unsigned short
		vector bool short
	vector signed int	vector signed int
		vector bool int
	vector bool int	vector signed int
		vector unsigned int
	vector unsigned int	vector unsigned int
		vector bool int
	vector signed long long	vector signed long long
		vector bool long long
vector bool long long	vector signed long long	
	vector unsigned long long	
vector unsigned long long	vector unsigned long long	
	vector bool long long	
vector double	vector double	

### **vec\_any\_gt: Any Element Greater Than**

`d = vec_any_gt(a, b)`

Tests whether any element of the first argument is greater than the corresponding element of the second argument. The result is 1 if any element of a is greater than the corresponding element of b. Otherwise, the result is 0.



Table 305. Any Element Greater Than

d	a	b
int	vector signed char	vector signed char
		vector bool char
	vector bool char	vector signed char
		vector unsigned char
	vector unsigned char	vector unsigned char
		vector bool char
	vector signed short	vector signed short
		vector bool short
	vector bool short	vector signed short
		vector unsigned short
	vector unsigned short	vector unsigned short
		vector bool short
	vector signed int	vector signed int
		vector bool int
	vector bool int	vector signed int
		vector unsigned int
	vector unsigned int	vector unsigned int
		vector bool int
	vector signed long long	vector signed long long
		vector bool long long
vector bool long long	vector signed long long	
	vector unsigned long long	
vector unsigned long long	vector unsigned long long	
	vector bool long long	
vector double	vector double	

### vec\_any\_le: Any Element Less Than or Equal

d = vec\_any\_le(a, b)

Tests whether any element of the first argument is less than or equal to the corresponding element of the second argument. The result is 1 if any element of a is less than or equal to the corresponding element of b. Otherwise, the result is 0.

Table 306. Any Element Less Than or Equal

d	a	b
int	vector signed char	vector signed char
		vector bool char
	vector bool char	vector signed char
		vector unsigned char
	vector unsigned char	vector unsigned char
		vector bool char
	vector signed short	vector signed short
		vector bool short
	vector bool short	vector signed short
		vector unsigned short
	vector unsigned short	vector unsigned short
		vector bool short
	vector signed int	vector signed int
		vector bool int
	vector bool int	vector signed int
		vector unsigned int
	vector unsigned int	vector unsigned int
		vector bool int
	vector signed long long	vector signed long long
		vector bool long long
vector bool long long	vector signed long long	
	vector unsigned long long	
vector unsigned long long	vector unsigned long long	
	vector bool long long	
vector double	vector double	

### vec\_any\_lt: Any Element Less Than

d = vec\_any\_lt(a, b)

Tests whether any element of the first argument is less than the corresponding element of the second argument. The result is 1 if any element of a is less than the corresponding element of b. Otherwise, the result is 0.

Table 307. Any Element Less Than

d	a	b
int	vector signed char	vector signed char
		vector bool char
	vector bool char	vector signed char
		vector unsigned char
	vector unsigned char	vector unsigned char
		vector bool char
	vector signed short	vector signed short
		vector bool short
	vector bool short	vector signed short
		vector unsigned short
	vector unsigned short	vector unsigned short
		vector bool short
	vector signed int	vector signed int
		vector bool int
	vector bool int	vector signed int
		vector unsigned int
	vector unsigned int	vector unsigned int
		vector bool int
	vector signed long long	vector signed long long
		vector bool long long
vector bool long long	vector signed long long	
	vector unsigned long long	
vector unsigned long long	vector unsigned long long	
	vector bool long long	
vector double	vector double	

### vec\_any\_nan: Any Element Not a Number

d = vec\_any\_nan(a)

Tests whether any element of the given vector is a NaN. The result is 1 if any element of a is a NaN. Otherwise, the result is 0.

Table 308. Any Element Not a Number

d	a
int	vector double

### vec\_any\_ne: Any Element Not Equal

d = vec\_any\_ne(a, b)

Tests whether any set of corresponding elements of the given vectors are not equal. The result is 1 if any element of a is not equal to the corresponding element of b. Otherwise, the result is 0.

Table 309. Any Element Not Equal

d	a	b
int	vector bool char	vector bool char
		vector signed char
		vector unsigned char
	vector signed char	vector bool char
		vector signed char
	vector unsigned char	vector bool char
		vector unsigned char
	vector bool short	vector bool short
		vector signed short
		vector unsigned short
	vector signed short	vector bool short
		vector signed short
	vector unsigned short	vector bool short
		vector unsigned short
	vector bool int	vector bool int
		vector signed int
		vector unsigned int
	vector signed int	vector bool int
		vector signed int
	vector unsigned int	vector bool int
		vector unsigned int
	vector bool long long	vector bool long long
		vector signed long long
		vector unsigned long long
	vector signed long long	vector bool long long
		vector signed long long
	vector unsigned long long	vector bool long long
		vector unsigned long long
vector double	vector double	

### vec\_any\_nge: Any Element Not Greater Than or Equal

d = vec\_any\_nge(a, b)

Tests whether any element of the first argument is not greater than or equal to the corresponding element of the second argument. The result is 1 if any element of a is not greater than or equal to the corresponding element of b. Otherwise, the result is 0.

Table 310. Any Element Not Greater Than or Equal

d	a	b
int	vector double	vector double

### **vec\_any\_ngt: Any Element Not Greater Than**

`d = vec_any_ngt(a, b)`

Tests whether any element of the first argument is not greater than the corresponding element of the second argument. The result is 1 if any element of a is not greater than the corresponding element of b. Otherwise, the result is 0.

*Table 311. Any Element Not Greater Than*

<b>d</b>	<b>a</b>	<b>b</b>
int	vector double	vector double

### **vec\_any\_nle: Any Element Not Less Than or Equal**

`d = vec_any_nle(a, b)`

Tests whether any element of the first argument is not less than or equal to the corresponding element of the second argument. The result is 1 if any element of a is not less than or equal to the corresponding element of b. Otherwise, the result is 0.

*Table 312. Any Element Not Less Than or Equal*

<b>d</b>	<b>a</b>	<b>b</b>
int	vector double	vector double

### **vec\_any\_nlt: Any Element Not Less Than**

`d = vec_any_nlt(a, b)`

Tests whether any element of the first argument is not less than the corresponding element of the second argument. The result is 1 if any element of a is not less than the corresponding element of b. Otherwise, the result is 0.

*Table 313. Any Element Not Less Than*

<b>d</b>	<b>a</b>	<b>b</b>
int	vector double	vector double

### **vec\_any\_numeric: Any Element Numeric**

`d = vec_any_numeric(a)`

Tests whether any element of the given vector is numeric (not a NaN). The result is 1 if any element of a is numeric (not a NaN). Otherwise, the result is 0.

*Table 314. Any Element Numeric*

<b>d</b>	<b>a</b>
int	vector double

## **Defining vector built-in functions from the operators**

The following function-like macros can be used to define some vector built-in functions, available on the XL C/C++ compilers for some other platforms, from the operators:

```
#define vec_neg(a) (-(a)) // Vector Negate
#define vec_add(a, b) ((a) + (b)) // Vector Add
#define vec_sub(a, b) ((a) - (b)) // Vector Subtract
```

```
#define vec_mul(a, b) ((a) * (b)) // Vector Multiply
#define vec_div(a, b) ((a) / (b)) // Vector Divide
#define vec_and(a, b) ((a) & (b)) // Vector AND
#define vec_or(a, b) ((a) | (b)) // Vector OR
#define vec_xor(a, b) ((a) ^ (b)) // Vector XOR
#define vec_sl(a, b) ((a) << (b)) // Vector Shift Left
#define vec_sra(a, b) ((a) >> (b)) // Vector Shift Right
#define vec_sr(a, b) ((a) >> (b)) // Vector Shift Right Algebraic
#define vec_slo(a, b) vec_slb(a, (b) << 64) // Vector Shift Left by Octet
#define vec_sro(a, b) vec_srb(a, (b) << 64) // Vector Shift Right by Octet
```

**Note:** The `vec_sra` macro definition must only be used with first parameter having a vector signed types. Similarly, the `vec_sr` macro definition must only be used for vector unsigned types, to have the correct bits inserted on the shifted out bits.



---

## Chapter 36. ANSI C/C++ 98 applications and C99

The z/OS XL C Compiler and z/OS Language Environment C runtime library are designed to support the *Programming languages - C (ISO/IEC 9899:1999)* standard and its amendments. This standard is commonly referred to as C99. The z/OS XL C++ compiler is also designed to support the latest ISO C++ 2003 (*Programming languages - C++ (ISO/IEC 14882:2003)*) standard and the latest technical corrigendum.

The compiler language additions for C99 do not apply to C++ applications because the C++ standard does not mandate support for C99.

---

### Obtaining C99 behavior with XL C

You obtain compiler behavior defined by the C99 language standard when you do either of the following:

- Use the **c89** command with **LANGLVL(STDC99)** option.
- Use the **c99** command (supported by the **x1c** utility) with the default language level.

When you want to obtain C99 extended support, do either of the following:

- Use the **c89** utility with the **LANGLVL(EXTC99)** option.
- Use the **c99** command with the **LANGLVL(EXTENDED)** option.

---

### Using C99 functions in XL C++ applications

IBM has made some C99 functions accessible to the XL C++ compiler. These C99 functions are enabled by the individual **LANGLVL** or **KEYWORD** suboptions.

You can also obtain C99 behavior with the XL C++ compiler by using the following **KEYWORD** and **LANGLVL** suboptions:

- **KEYWORD(RESTRICT)** or **LANGLVL(EXTENDED)**, which enable the restrict qualifier for improved aliasing information.
- **LANGLVL(UCS)**, which enables support for valid universal character name ranges.
- **LANGLVL(C99\_\_FUNC\_\_)** or **LANGLVL(EXTENDED)**, which enable the `__func__` identifier for debugging assistance.

C++ applications can also access C99 runtime library functions by using feature test macros. See “Feature test macros that control C99 interfaces in XL C++ applications.”

### Feature test macros that control C99 interfaces in XL C++ applications

The following C99 headers are not available to C++ applications:

- `<tgmath.h>`
- `<complex.h>` — If `<complex.h>` is included, the USL Complex Class Library version of this header file will be used.
- `<stdbool.h>`



To expose C99 interfaces, C++ applications can define the appropriate feature test macros before including the identified header:

#### **`__ISOC99_SOURCE`**

Used to control exposure to new C99 interfaces that do not require a C99-compliant compiler. The application programmer defines this feature test macro to inform the compile time library that new C99 interfaces are desired. This feature test macro must be defined prior to inclusion of the first header in order to expose the new C99 interfaces that do not require a C99-compliant compiler. This feature test macro requires a minimum of the z/OS V1R2 C/C++ compiler and TARGET(zOSV1R5) in order to expose the new C99 interfaces.

#### **`__STDC_LIMIT_MACROS`**

Required by C++ applications wishing to expose limits of fixed-width integer types and limits of other integer types as documented in `<stdint.h>`. The `__ISOC99_SOURCE` feature test macro must be defined before this feature test macro.

#### **`__STDC_CONSTANT_MACROS`**

Required by C++ applications wishing to expose macros for integer constants as documented in `<stdint.h>`. The `__ISOC99_SOURCE` feature test macro must be defined before this feature test macro.

#### **`__STDC_FORMAT_MACROS`**

Required by C++ applications wishing to expose macros for format specifiers as documented in `<inttypes.h>`. The `__ISOC99_SOURCE` feature test macro must be defined before this feature test macro.

#### **`__TR1_C99`**

Used to control exposure to the C++ TR1 C99 name space as described in Chapter 8 of *ISO/IEC DTR 19768: Draft Technical Report on C++ Library Extensions*.

## **Using C99 functions in C++ applications when ambiguous definitions exist**

The C++ standard namespace does not include any C99 functions. Therefore, when ambiguous definitions exist, C++ applications must access these functions through the global namespace. The syntax of the global namespace is `::function()`.

XL C++ applications that need C99 interfaces must use the required feature macros or, when ambiguous definitions exist, global namespace syntax (when ambiguous definitions exist).

Figure 166 on page 679 is an example of code that requires the global namespace syntax. In this example, `std::` is not allowed for C99 interfaces.

---

```
#include <cstdio>
namespace FRED {
    int snprintf(char *b, size_t x, const char *f, ...) { return(x); }
};
using namespace FRED;
main() {
    char buf[512];
    int rc;
    /*rc = snprintf(buf,32,"hello\n");      AMBIGUOUS */
    rc = ::snprintf(buf,32,"hello\n");
    rc = FRED::snprintf(buf,32,"hello\n");
    /*rc = std::snprintf(buf,32,"hello\n"); NOT ALLOWED */
}
```

---

*Figure 166. Example of code that requires the global namespace syntax*



---

## Chapter 37. Writing applications for Single UNIX Specification, Version 3

As of z/OS V1R9, the most current UNIX standard, Single UNIX Specification, Version 3 (SUSv3), is defined by IEEE Std 1003.1-2001, updated in 2004 with the integration of the two corrigenda issued subsequent to the 2001 release. The standard, also known as The Open Group Base Specifications Issue 6, is aligned with the ISO/IEC 9899:1999 Programming Languages - C standard. The new UNIX standard draws from the POSIX.1 and POSIX.2 specifications and their amendments, as well as The Open Group Base Specifications Issue 5 and The Open Group Technical Standard, January 2000, Networking Services, Issue 5.2.

For complete details about the normative references and base documents that underlie Single UNIX Specification, Version 3, see the introduction to the Base Definitions volume of IEEE Std 1003.1-2001.

In z/OS V1R9, the XL C/C++ Runtime Library provides a high degree of support for the Single UNIX Specification, Version 3. With the exception of the list of known non-compliances, library users may expect most conforming SUSv3 applications to compile and run on the z/OS platform in conformance with the standard.

---

### Announcing your intentions

When compiling with system headers, there is a standard announcement mechanism for applications to notify the compiler that they are written for SUSv3. Notification is accomplished through the use of feature test macros `_POSIX_C_SOURCE` and `_XOPEN_SOURCE`. Applications insert either of the following definitions before any system header `#include` directives:

- `#define _POSIX_C_SOURCE 200112L` - Exposes the base POSIX namespace of SUSv3.
- `#define _XOPEN_SOURCE 600` - Exposes the X/Open System Interface (XSI) extension of SUSv3.

Because XSI is a superset of the POSIX base, `_POSIX_C_SOURCE 200112L` is implicit in the definition of `_XOPEN_SOURCE 600` and does not need to be defined when `_XOPEN_SOURCE 600` is defined.

Several other implementation-specific feature test macros impact support of SUSv3. An application may request SUSv3 threads support by defining `_UNIX03_THREADS` or as part of XSI. Because the Threads Option is a required component of XSI, you do not need to define `_UNIX03_THREADS` when `_XOPEN_SOURCE 600` is defined. Another new macro, `_UNIX03_WITHDRAWN`, preserves symbols withdrawn from the UNIX standard, making them visible in the SUSv3 namespace.

Before z/OS V1R9, other feature test macros enabled subsets of SUSv3 functionality. The `_UNIX03_SOURCE` macro has been used to expose a number of SUSv3 functions and constants missing from the XL C/C++ Runtime Library, before the more general implementation of SUSv3 in z/OS V1R9. The macro is additive, in that for a given target release, the compiler exposes all symbols exposed by `_UNIX03_SOURCE` for the target and any prior release. Given that any

symbol it exposes is part of XSI, the `_UNIX03_SOURCE` macro is subsumed by `_XOPEN_SOURCE 600`, and is redundant when the latter is defined.

Like `_UNIX03_SOURCE`, the definition of `_OPEN_THREADS 2` or `_OPEN_THREADS 3` enables a specific subset of SUSv3 threads interfaces. Similarly, these interfaces are also exposed by defining `_XOPEN_SOURCE 600` (or `_UNIX03_THREADS`). However, there are behavioral differences and some differences in the naming of constants. With `_OPEN_THREADS`, other than the new functions, which are SUSv3 compliant, the remainder of the thread-related functions behave according to the POSIX.4a, draft 6 specification, which differs from SUSv3.

Program developers have the option of writing SUSv3 applications that still use the old threads behavior. An application may override the implicit XSI threads behavior by defining both `_OPEN_THREADS` and `_XOPEN_SOURCE 600`, if there is a reason to maintain the previous POSIX.4a, draft 6 behavior. On the other hand, concurrent definition of the `_UNIX03_THREADS` and `_OPEN_THREADS` macros is not allowed and will generate a compile-time error message.

The intent of the XL C/C++ Runtime Library SUSv3 implementation is to maintain a great deal of flexibility and choice, supporting as many customer environments as possible. As in the case of `_OPEN_THREADS`, you can use most feature test macros that provide implementation-specific extensions with the SUSv3 macros, with the understanding that the resulting namespace does not conform to SUSv3. For more specific details about requirements or restrictions, see the individual feature test macros in *Feature Test Macros in z/OS XL C/C++ Runtime Library Reference*.

In addition to the feature test macros controlling that symbols are exposed in the system headers, two new environment variables determine behaviors at run time. In both cases, these variables impact error handling, enabling paths to provide errno information and fail a function for errors that were not previously detected. Default behavior for affected functions is unchanged. The new behavior must be explicitly enabled through a new setting of the environment variable.

- `_EDC_SUSV3` - Default is unset. For parts of SUSV3 behavior, set to 1. For additional pole error related SUSV3 behavior, set to 2.
- `_EDC_EOVERFLOW` - Default is NO. For new behavior, set to YES.

When `_EDC_SUSV3=1`, SUSV3 error handling occurs in `setenv()`, `readdir()`, `getnameinfo()`, and `tcgetsid()`. When `_EDC_SUSV3=2`, in addition to behaviors introduced by `_EDC_SUSV3=1`, error handling compliant with SUSV3 occurs in `log()`, `logf()`, `logl()`, `log10()`, `log10f()`, `log10l()`, `log1p()`, `log1pf()`, `log1pl()`, `log2()`, `log2f()`, `log2l()`, `pow()`, and `powl()`. With `_EDC_EOVERFLOW=YES`, overflow detection takes place in `ftell()`, `fseek()`, `fstat()`, `lstat()`, `stat()`, and `mmap()`. The `Eoverflow` error checking is for 31-bit applications only. For more specific information about behavior affected by these environment variables, see the individual function descriptions in *z/OS XL C/C++ Runtime Library Reference*.

---

## Testing the environment

Many symbols have been added in `<limits.h>` and `<unistd.h>` to support SUSv3. Some of these symbols are tested at compile time by the preprocessor to allow differential compiles based on the values found, while others are intended for use by `sysconf()`, `pathconf()`, `fpathconf()`, and `confstr()` to test the version of the

standard and availability of options at run time. Table 315 lists the SUSv3 options and option groups supported by the XL C/C++ Runtime Library:

*Table 315. SUSv3 options and option groups*

Description	Symbol Name
File Synchronization	_POSIX_FSYNC
Memory Mapped Files	_POSIX_MAPPED_FILES
Memory Protection	_POSIX_MEMORY_PROTECTION
Realtime Signals Extension	_POSIX_REALTIME_SIGNALS
Thread Stack Address Attribute	_POSIX_THREAD_ATTR_STACKADDR
Thread Stack Size Attribute	_POSIX_THREAD_ATTR_STACKSIZE
Thread Process-Shared Synchronization	_POSIX_THREAD_PROCESS_SHARED
Thread-Safe Functions	_POSIX_THREAD_SAFE_FUNCTIONS
Threads	_POSIX_THREADS
Encryption Option Group	_XOPEN_CRYPT
Legacy Option Group	_XOPEN_LEGACY
XSI Streams Option Group	_XOPEN_STREAMS
XSI Extension	_XOPEN_UNIX

---

## What is different in SUSv3

The SUSv3 implementation adds a number of new functions to the XL C/C++ Runtime Library, while applying modifications to the signatures of some existing functions in SUSv3 as result of the following behaviors:

- Addition or removal of arguments.
- Use of const declarator.
- Specialization of argument types.
- Use of restrict keyword.

The SUSv3 namespace excludes all withdrawn headers, functions, external variables, and constants. The specification further targets additional symbols for removal in a future version of the standard.

As noted earlier, Single UNIX Specification, Version 3 aligns with ISO/IEC 9899:1999, is commonly referred to as the C99 language standard. In some cases, SUSv3 extends the C99 definition, although in the case of a conflict, it always defers to the C99 standard. For this reason, applications compiled for SUSv3 are also implicitly C99, and you do not need to define feature test macro `_ISOC99_SOURCE` when `_XOPEN_SOURCE 600` or `_POSIX_C_SOURCE 200112L` is defined.

Beyond these obvious differences in the library, there are other behavioral differences. One of the more notable differences is the change in the return value of most threads functions. The POSIX.4a, draft 6 threads behavior indicates a return of -1 on failure with the error code set in `errno`. In SUSv3, the majority of these functions now return the error code on failure rather than a value of -1. With the exception of `pthread_getspecific()`, the z/OS implementation will continue to set `errno` in addition to returning the error code.

For complete details about syntactical differences and special behavior of functions, see the individual function descriptions in *z/OS XL C/C++ Runtime Library Reference*.

---

## Symbols withdrawn in SUSv3

Functions, headers, and external variables that comprised the Legacy Feature Group in Single UNIX Specification, Version 2 are removed and not part of SUSv3. Also, any symbols that were marked obsolescent in Version 2 have been removed.

For a complete list of the withdrawn symbols, see the description of `_UNIX03_WITHDRAWN` in Feature Test Macros in *z/OS XL C/C++ Runtime Library Reference*. In the case of headers that have been withdrawn, there is no special mechanism employed. An application simply includes them, like any other non-standard header. The withdrawn headers are `<re_comp.h>`, `<regex.h>`, and `<varargs.h>`. Dependencies on symbols that are not part of the SUSv3 namespace affect portability and, if this is an issue, make such applications nonconforming.

---

## Candidates for removal in a future version

In addition to symbols withdrawn from the SUSv3 namespace, a number of symbols have been marked obsolete in the POSIX base or added to the Legacy Option for XSI that may be removed from the Single UNIX Specification in a future version.

**Obsolescent:** `bsd_signal()`, `gethostbyaddr()`, `gethostbyname()`, `h_errno`, `pthread_attr_getstackaddr()`, `pthread_attr_setstackaddr()`, `scalb()`, `ualarm()`, `usleep()`, `vfork()`

**Legacy Option** `bcmp()`, `bcopy()`, `bzero()`, `ecvt()`, `fcvt()`, `ftime()`, `gcvt()`, `getwd()`, `index()`, `mktemp()`, `rindex()`, `utimes()`, `wcswcs()`

---

## Implementation compliance

IBM makes no claim that the z/OS platform complies with Single UNIX Specification, Version 3 or that the z/OS XL C/C++ Runtime Library contains a complete implementation of the C programming interfaces and headers found in the Base Definitions of this standard. While the library implementation comes close, a number of known discrepancies remain in z/OS R9. The following summary lists those discrepancies from SUSv3 behavior that have been identified.

The z/OS XL C/C++ Runtime Library does not support:

- `accept()` – `ECONNABORTED` from `accept()` when a connection has been aborted.
- `alarm()` and `setitimer()` deliver `SIGALRM` to the thread that invoked the service rather than at the process level.
- `exec()` family of functions in a multi-threaded environment.
- `fgetc()`, `fgetwc()`, `read()` – `E_OVERFLOW` in `fgetc()`, `fgetwc()`, or `read()` when reading at or beyond a file offset maximum.
- `getsockopt()`, `setsockopt()` – Options `SO_DONTROUTE`, `SO_RCVLOWAT`, `SO_RCVTIMEO`, `SO_SNDLOWAT`, `SO_SNDTIMEO` in `getsockopt()` or `setsockopt()`.

`EDOM` in `setsockopt()` when send/receive timeout values are too big to fit into the timeout fields in the socket structure.

EISCONN in setsockopt() when socket is already connected and a specified option cannot be set while the socket is connected.

- fpathconf() and pathconf() do not support the symbols shown in Table 316.

Table 316. Symbols not supported

_PC_FILESIZEBITS	(FILESIZEBITS)
_PC_2_SYMLINKS	(POSIX2_SYMLINKS)
_PC_ALLOC_SIZE_MIN	(POSIX_ALLOC_SIZE_MIN)
_PC_REC_INCR_XFER_SIZE	(POSIX_REC_INCR_XFER_SIZE)
_PC_REC_MAX_XFER_SIZE	(POSIX_REC_MAX_XFER_SIZE)
_PC_REC_MIN_XFER_SIZE	(POSIX_REC_MIN_XFER_SIZE)
_PC_REC_XFER_ALIGN	(POSIX_REC_XFER_ALIGN)
_PC_SYMLINK_MAX	(SYMLINK_MAX)
_PC_ASYNC_IO	(_POSIX_ASYNC_IO)
_PC_PRIO_IO	(_POSIX_PRIO_IO)
_PC_SYNC_IO	(_POSIX_SYNC_IO)

- mmap() – ENXIO in mmap() when MAP\_FIXED is specified in flags and the combination of addr, len, and off is not valid for the fildes object.
- msync() – EBUSY during msync() when some or all addresses in the range starting at addr and continuing for len bytes are locked, and MS\_INVALIDATE is specified.
- recvmsg() – EMSGSIZE in recvmsg() when msg\_iovlen in the msghdr pointed to by message is less than or equal to 0, or is greater than {IOV\_MAX}.
- regexec() - Use of the restrict keyword is not supported.
- socket(), socketpair() – SOCK\_SEQPACKET type in socket() and socketpair().
- stderr open for reading.





---

## Chapter 38. Saved compile-time options information

Following a successful compilation, the application executable file will always include compile-time options information in a compact form. This information supports determination of runtime problems. Saved compile-time options information includes:

- Fixed subset of compilation options for each source file compiled.
- Source file name for each source file compiled.
  - The source file name of the compilation unit for which the options are saved is the first entry in the source file and component version information block.
  - For names longer than 252 characters, only the last 252 bytes of the source file name are provided.
  - The name does not include path information for UNIX files and only the member name is provided for partitioned data sets.
  - A dummy name "IPA Link" is provided for programs optimized with IPA.
- Version information for each compiler component that is active during the compilation.
  - You can use the version information to determine the compile-time maintenance level. If the maintenance level is not the most current, there might be an update available that solves the problem.
  - This version information will be the same as the information produced using the PHASEID compiler option. For further information about the PHASEID compiler option, see *z/OS XL C/C++ User's Guide*.
  - Although information about the debug writer is not included because the debug writer runs after the code generation, that information is available inside the .dbg file.

A compilation flag in the Program Prolog Area-2 (PPA2) indicates the presence of saved options information. If the service string is specified, the saved option string follows it. Otherwise the saved options information follows the time stamp string. For more information about PPA2, see *z/OS Language Environment Vendor Interfaces*.

---

## Saved options information layout

Figure 167 shows the layout of the saved options information.

```
#define USHRT unsigned short
#define UINT unsigned int

typedef struct SOS_s {
    UINT  sos_words      : 8, /* 0xFF000000 sizeof(SOS)/4 */
        sos_version    : 8, /* 0x00FF0000 version number */
        /* 1 - as of XL C/C++ 1.10 */
        /* 2 - as of XL C/C++ 1.11 */
        /* 3 - as of XL C/C++ 1.13 */
        /* 4 - as of XL C/C++ 2.1 */
        /* 5 - as of XL C/C++ 2.1 PTF */
        /* 6 - as of XL C/C++ 2.1.1 */
        /* 7 - as of XL C/C++ 2.2 */
        sos_arch       : 8, /* 0x0000FF00 ARCHITECTURE */
        sos_tune       : 8; /* 0x000000FF TUNE */

    /* offset: 4 */

    UINT  sos_csect      : 1, /* 0x80000000 0 - NOCSECT */
        /* 1 - CSECT */
        sos_version_info :15, /* 0x7FFF0000 version list (PHASEIDs location - */
        /* offset/4 from SOS start) */
        sos_locale_ccsid :16; /* 0x0000FFFF CCSID from the LOCALE */

    /* offset: 8 */

    USHRT sos_lit_ccsid; /* 0xFFFF0000 CONVLIT(xx) */
    USHRT sos_wlit_ccsid; /* 0x0000FFFF CONVLIT(,WCHAR|UNICODE) */

    /* offset: 12 */

    UINT  sos_target_rel; /* 0xFFFFFFFF TARGET(release value in HEX) */
        /* As given by __TARGET_LIB__ */

    /* offset: 16 */

    UINT  sos_initauto_val; /* 0xFFFFFFFF INITAUTO value */
}
```

*Definition of saved options information layout (Part 1 of 5)*

*Figure 167. Definition of saved options information layout*

```

/* offset: 20 */
UINT  sos_enumsize      : 3, /* 0xE0000000 0 - ENUMSIZE(SMALL)          */
/*                                     1 - ENUMSIZE(INT)           */
/*                                     2 - ENUMSIZE(INTLONG)        */
/*                                     3 - ENUMSIZE(1)              */
/*                                     4 - ENUMSIZE(2)              */
/*                                     5 - ENUMSIZE(4)              */
/*                                     6 - ENUMSIZE(8)              */
      sos_round         : 3, /* 0x1C000000 0 - ROUND(N)                */
/*                                     1 - ROUND(Z)                */
/*                                     2 - ROUND(P)                */
/*                                     3 - ROUND(M)                */
      sos_round_dfp     : 4, /* 0x03C00000 0 - NODFP                    */
/*                                     1 - ROUND(DN)                */
/*                                     2 - ROUND(DM)                */
/*                                     3 - ROUND(DP)                */
/*                                     4 - ROUND(DZ)                */
/*                                     5 - ROUND(DNA)               */
/*                                     6 - ROUND(DI)                */
/*                                     7 - ROUND(DNZ)               */
      sosflt_hex        : 1, /* 0x00200000 0 - FLOAT(HEX)              */
/*                                     1 - FLOAT(IEEE)             */
      sosflt_afp        : 2, /* 0x00180000 0 - FLOAT(NOAFP)            */
/*                                     1 - FLOAT(AFP(NOVOLATILE))    */
/*                                     2 - FLOAT(AFP(VOLATILE))     */
      sosflt_fold       : 1, /* 0x00040000 FLOAT(FOLD)                */
      sosflt_maf        : 1, /* 0x00020000 FLOAT(MAF)                 */
      sosflt_rrm        : 1, /* 0x00010000 FLOAT(RRM)                 */
      sos_aggrcopy      : 1, /* 0x00008000 0 - AGGRCOPY(NOOVERLAP)    */
/*                                     1 - AGGRCOPY(OVERLAP)       */
      sos_bitfield      : 1, /* 0x00004000 0 - BITFIELD(UNSIGNED)     */
/*                                     1 - BITFIELD(SIGNED)       */
      sos_chars         : 1, /* 0x00002000 0 - CHARS(UNSIGNED)        */
/*                                     1 - CHARS(SIGNED)           */
      sos_hgpr          : 2, /* 0x00001800 0 - NOHGPR                  */
/*                                     1 - HGPR(PRESERVE)          */
/*                                     2 - HGPR(NOPRESERVE)       */
      sos_initauto      : 2, /* 0x00000600 0 - NOINITAUTO             */
/*                                     1 - INITAUTO (xx)           */
/*                                     2 - INITAUTO (xx, WORD)    */
      sos_inline        : 2, /* 0x00000180 0 - NOINLINE                */
/*                                     1 - INLINE(AUTO)           */
/*                                     2 - INLINE(NOAUTO)         */
      sos_ipa           : 2, /* 0x00000060 0 - NOIPA                   */
/*                                     1 - IPA(OBJECT)             */
/*                                     2 - IPA(NOOBJECT)           */
/*                                     3 - IPA(OBJONLY)           */
      sos_unroll        : 2, /* 0x00000018 0 - UNROLL(AUTO)            */
/*                                     1 - UNROLL(NO)              */
/*                                     2 - UNROLL(YES)            */
      sos_dll           : 2, /* 0x00000006 0 - NODLL                   */
/*                                     1 - DLL(NOCALLBACKANY)     */
/*                                     2 - DLL(CALLBACKANY)       */
      sos_exportall     : 1; /* 0x00000001 EXPORTALL                   */

```

*Definition of saved options information layout (Part 2 of 5)*

```

/* offset: 24 */

UINT  sos_ansialias      : 1, /* 0x80000000 ANSIALIAS */
      sos_argparse      : 1, /* 0x40000000 ARGPARSE */
      sos_compress      : 1, /* 0x20000000 COMPRESS */
      sos_compact       : 1, /* 0x10000000 COMPACT */
      sos_execops       : 1, /* 0x08000000 EXECOPS */
      sos_goff          : 1, /* 0x04000000 GOFF */
      sos_hot           : 1, /* 0x02000000 HOT */
      sos_ignerrno      : 1, /* 0x01000000 IGNERRNO */
      sos_libansi       : 1, /* 0x00800000 LIBANSI */
      sos_upconv        : 1, /* 0x00400000 UPCONV */
      sos_longname      : 1, /* 0x00200000 LONGNAME */
      sos_lp64          : 1, /* 0x00100000 LP64 */
      sos_rent          : 1, /* 0x00080000 0 - NORENT */
                        /* 1 - RENT */
      sos_wsizeof       : 1, /* 0x00040000 WSIZEOF */
      sos_roconst       : 1, /* 0x00020000 ROCONST */
      sos_rostring      : 1, /* 0x00010000 ROSTRING */
      sos_start         : 1, /* 0x00008000 START */
      sos_strict        : 1, /* 0x00004000 STRICT */
      sos_strictind     : 1, /* 0x00002000 STRICT_INDUCTION */
      sos_xpl_bkchn     : 1, /* 0x00001000 XPLINK(BACKCHAIN) */
      sos_xpl_callbk    : 1, /* 0x00000800 XPLINK(CALLBACK) */
      sos_xpl_grd       : 1, /* 0x00000400 XPLINK(GUARD) */
      sos_xpl_oscalls   : 2, /* 0x00000300 0 - XPLINK(OSCALL(NOSTACK)) */
                        /* 1 - XPLINK(OSCALL(DOWNSTACK)) */
                        /* 2 - XPLINK(OSCALL(UPSTACK)) */
      sos_hook_line     : 1, /* 0x00000080 DEBUG(HOOK(LINE)) */
      sos_hook_block    : 1, /* 0x00000040 DEBUG(HOOK(BLOCK)) */
      sos_hook_path     : 1, /* 0x00000020 DEBUG(HOOK(PATH)) */
      sos_hook_func     : 1, /* 0x00000010 DEBUG(HOOK(FUNC)) */
      sos_hook_call     : 1, /* 0x00000008 DEBUG(HOOK(CALL)) */
      sos_debug_sym     : 1, /* 0x00000004 DEBUG(SYMBOL) */
      sos_debug_fmt     : 2; /* 0x00000003 0 - NODEBUG */
                        /* 1 - DEBUG(FORMAT(ISD)) */
                        /* 2 - DEBUG(FORMAT(DWARF)) */

```

*Definition of saved options information layout (Part 3 of 5)*

```

/* offset: 28 */
UINT  sos_gonumber      : 1, /* 0x80000000 GONUMBER */
      sos_target        : 2, /* 0x60000000 0 - TARGET (LE) */
      /*                /* 1 - TARGET (IMS) */
      sos_plist         : 1, /* 0x10000000 0 - PLIST (HOST) */
      /*                /* 1 - PLIST (OS) */
      sos_optlevel      : 4, /* 0x0F000000 OPTIMIZE */
      sos_redir         : 1, /* 0x00800000 REDIR */
      sos_cvft          : 1, /* 0x00400000 CVFT */
      sos_objmodel      : 2, /* 0x00300000 0 - OBJECTMODEL (CLASSIC) */
      /*                /* 1 - OBJECTMODEL (IBM) */
      sos_exh           : 1, /* 0x00080000 EXH */
      sos_rtti          : 1, /* 0x00040000 RTTI */
      sos_namemangling  : 6, /* 0x0003F000 0 - NAMEMANGLING (zOSV1R2) and */
      /*                /* NAMEMANGLING (ZOSV1R5_DEFAULT) */
      /*                /* 1 - NAMEMANGLING (ANSI) */
      /*                /* 2 - NAMEMANGLING (COMPAT) and */
      /*                /* NAMEMANGLING (OSV2R10) */
      /*                /* 3 - NAMEMANGLING (ZOSV1R5_ANSI) */
      /*                /* 4 - NAMEMANGLING (ZOSV1R7_ANSI) */
      /*                /* 5 - NAMEMANGLING (ZOSV1R8_ANSI) */
      /*                /* 6 - NAMEMANGLING (ZOSV1R9_ANSI) */
      /*                /* 7 - NAMEMANGLING (ZOSV1R10_ANSI) */
      /*                /* 8 - NAMEMANGLING (ZOSV1R11_ANSI) */
      /*                /* 9 - NAMEMANGLING (ZOSV1R12_ANSI) */
      /*                /* 10 - NAMEMANGLING (ZOSV2R1_ANSI) */
      /*                /* 11 - NAMEMANGLING (ZOSV2R1M1_ANSI) */
      sos_ansisinit     : 1, /* 0x00000800 LANGLVL (ANSISINIT) */
      sos_newexcp       : 1, /* 0x00000400 LANGLVL (NEWEXCP) */
      sos_oldmath       : 1, /* 0x00000200 LANGLVL (OLDMATH) */
      sos_oldstr        : 1, /* 0x00000100 LANGLVL (OLDSTR) */
      sos_oldtplalign   : 1, /* 0x00000080 LANGLVL (OLDTPLALIGN) */
      sos_restrict     : 1, /* 0x00000040 ASSERT (RESTRICT) */
      sos_prefetch     : 1, /* 0x00000020 PREFETCH */
      /*                /* Applicable to zOSV1R11 and later */
      sos_rtc           : 1, /* 0x00000010 RTCHECK */
      /*                /* Applicable to zOSV1R11 and later */
      sos_rtc_bounds   : 1, /* 0x00000008 RTCHECK (BOUNDS) */
      /*                /* Applicable to zOsV1R11 and later */
      sos_rtc_divzero   : 1, /* 0x00000004 RTCHECK (DIVZERO) */
      /*                /* Applicable to zOsV1R11 and later */
      sos_rtc_nullptr   : 1, /* 0x00000002 RTCHECK (NULLPTR) */
      /*                /* Applicable to zOsV1R11 and later */
      sos_restrict_param : 1; /* 0x00000001 RESTRICT */
      /*                /* Applicable to zOsV1R12 and later */

```

*Definition of saved options information layout (Part 4 of 5)*

```

/* offset: 32 */
UNIT  sos_rvaluerefs      : 1, /* 0x80000000  LANGLVL(RVALUEREFERENCES)      */
      /* Applicable to zOSV2R1 and later      */
      sos_refcollapsing  : 1, /* 0x40000000  LANGLVL(REFERENCECOLLAPSING)   */
      /* Applicable to zOSV2R1 and later      */
      sos_rightanglebkt  : 1, /* 0x20000000  LANGLVL(RIGHTANGLEBRACKET)     */
      /* Applicable to zOSV2R1 and later      */
      sos_scopedenum     : 1, /* 0x10000000  LANGLVL(SCOPEENUM)             */
      /* Applicable to zOSV2R1 and later      */
      sos_debug_level    : 4, /* 0x0F000000  DEBUG(LEVEL(0-9))             */
      /* Applicable to zOSV2R1 and later      */
      sos_subscript_wrap : 1, /* 0x00800000  STRICT(SUBSTRICTWRAP)         */
      /* Applicable to zOSV2R1 and later      */
      sos_tempsaslocals  : 1, /* 0x00400000  LANGLVL(TEMPSASLOCALS)       */
      /* Applicable to zOSV1R13 and later     */
      sos_smp            : 1, /* 0x00200000  SMP                           */
      /* Applicable to zOSV2R1 and later      */
      sos_smp_opt        : 1, /* 0x00100000  SMP(OPT)                      */
      /* Applicable to zOSV2R1 and later      */
      sos_smp_explicit   : 1, /* 0x00080000  SMP(EXPLICIT)                 */
      /* Applicable to zOSV2R1 and later      */
      sos_threaded       : 1, /* 0X00040000  THREADED                      */
      /* Applicable to zOSV2R1 and later      */
      sos_funcevent      : 1, /* 0x00020000  FUNCEVENT                     */
      /* Applicable to zOSV2R1M1 and later   */
      sos_vector         : 1, /* 0x00010000  VECTOR                        */
      /* Applicable to zOSV2R1M1 and later   */
      sos_asm            : 1, /* 0x00008000  ASM                           */
      /* Applicable to zOSV2R1M1 and later   */
      sos_unrolln        : 8, /* 0x00007F80  UNROLL(N) where 0 <= N <= 255 */
      /* Applicable to zOSV2R1M1 and later   */
      sos_check_pl_new   : 1, /* 0x00000040  LANGLVL(CHECKPLACEMENTNEW)    */
      /* Applicable to zOSV2R1M1 and later   */
      sos_check_new      : 1, /* 0x00000020  CHECKNEW                      */
      /* Applicable to zOSV2R2 and later     */
      sos_vector_is_type : 1, /* 0x00000010  VECTOR(TYPE)                 */
      /* Applicable to zOSV2R2 and later     */
      sos_vector_autosimd: 1, /* 0x00000008  VECTOR(AUTOSIMD)             */
      /* Applicable to zOSV2R2 and later     */
      sos_padding        : 3;
} SOS_t;

```

*Definition of saved options information layout (Part 5 of 5)*

---

## Part 5. Performance optimization

This part describes guidelines for improving the performance of your XL C/C++ application. Performance improvement can be achieved through coding, compiling, and the runtime environment. The following chapters discuss guidelines for these three areas:

- Chapter 39, “Improving program performance,” on page 695
- Chapter 40, “Using built-in functions to improve performance,” on page 715
- Chapter 41, “I/O Performance considerations,” on page 719
- Chapter 42, “Improving performance with compiler options,” on page 723
- Chapter 45, “Optimizing the system and Language Environment,” on page 777
- Chapter 46, “Balancing compilation time and application performance,” on page 781
- Chapter 47, “Stepping through optimized code using the dbx debugger utility,” on page 785

You may also find useful information in the IBM Redbook *Tuning Large C/C++ Applications on z/OS UNIX System Services*. This Redbook is available on the web at <http://www.redbooks.ibm.com/abstracts/sg245606.html>.





---

## Chapter 39. Improving program performance

This information discusses coding guidelines that improve the performance of a C or C++ application. While they are most effective when creating new code, these guidelines can also provide a gradual performance improvement when they are consistently used when porting or fixing areas of the code. The guidelines cover the following topics:

- “Writing code for performance”
- “Using C++ constructs in performance-critical code”
- “Using explicit instantiation declarations (C++11 only)” on page 697
- “ANSI aliasing rules” on page 697
- “Using ANSI aliasing rules” on page 699
- “Using variables” on page 701
- “Passing function arguments” on page 702
- “Coding expressions” on page 703
- “Coding conversions” on page 704
- “Arithmetical considerations” on page 704
- “Using loops and control constructs” on page 704
- “Choosing a data type” on page 705
- “Examples” on page 717
- “Using library extensions” on page 707
- “Using #pragmas” on page 708
- “Using rvalue references (C++11)” on page 710

---

### Writing code for performance

When you write code, it is a good practice to write it so that you can understand it when you simply read it on a printed page or on a screen, without having to refer to anything else. If the code is simple and concise, both the programmer and the compiler can understand it easily. Code that is easy for the compiler to understand is also easy for it to optimize. If you follow this practice you might not only create code that performs well on execution, you might also create code that compiles more quickly.

If you follow the guidelines in this information, you will create code that performs well on execution and can be compiled efficiently.

---

### Using C++ constructs in performance-critical code

**Note:** The discussion in this information applies to high-level language constructs that might seriously degrade the performance of C++ programs. All other coding discussions in this information apply to both C and C++ programs.

Be aware that in C++, more than in C, certain coding constructs can lead to n-to-1, m-to-1 or even z-to-1 code expansion. You can create well-performing code with these constructs, but you must use them carefully and appropriately, especially when you are writing critical-path or high-frequency code.

When writing performance-critical C++ programs, ensure that you understand why problems might occur and what you can do about them if you use any of the following high-level language constructs:

### **Virtual**

The `virtual` construct is an important part of object-oriented coding and can be very useful in removing the `if` and `switch` logic from an application. Programmers often use `virtual` and `neglect` to remove the `switch` logic. Note the following:

- The use of a `virtual` construct (like the use of a pointer and unlike the use of `if` statements) prevents the compiler from knowing how that construct is defined, which would provide the compiler with an optimization opportunity. In other words, when you use a `virtual` construct instead of `if` or `switch` statements, you limit optimization opportunities.
- In a non-XPLINK module, because of function overhead, `virtual` functions are costlier to execute than straight-line code with `if` or `switch` statements.

### **Exception handling**

When exception handling is available (that is, when you are using the EXH compiler option), opportunities for both normal optimizations and for inlining are limited. This is because the compiler must generate extra code to keep track of execution events and to ensure that all required objects are caught by the correct routines.

When you use the C++ `try` and `catch` blocks, the compiler creates obstacles to optimization. The compiler cannot pull common code out of a `try` block because it might trigger an exception that would need to be caught. Similarly, code cannot be pulled out of a `catch` block because:

- The code in a `catch` block is triggered far down the call chain, after the exception has occurred
- After a `catch` has occurred, the compiler must ensure that all requested tasks have been executed

You might improve compiler performance by:

- Removing dependencies on C++ exception handling from your code
- Compiling with the NOEXH compiler option

### **Dynamic casts/Runtime type identification (RTTI)**

A dynamic cast (also known as RTTI) is a coding construct that delays, until run time, the determination of which code is to be executed. This limits the potential for optimization. In addition, the process of actually doing the dynamic cast involves multiple function calls and large amounts of code.

**Note:** We strongly recommend that RTTI/dynamic casts not be used in performance-critical code. You can often avoid the use of RTTI through careful application design.

### **iostream**

As discussed in Chapter 4, "Using the Standard C++ Library I/O Stream Classes," on page 23 and in Chapter 9, "Using C and C++ standard streams and redirection," on page 63, `iostream` is often built upon the standard C I/O library (`fprintf`, `fopen`, `fclose`, `fread`, `fwrite`). For I/O performance-critical portions of your application, it is often faster to use the C I/O functions explicitly instead of `iostream`.

**Note:** You must be careful if you are mixing the C++ stream classes with the C library. For more information, see Chapter 4, “Using the Standard C++ Library I/O Stream Classes,” on page 23.

### **Standard Template Library and other class libraries**

These libraries are very convenient and are often well coded, but you must remember that each use of a class can involve one or more function calls. If you keep this in mind when coding, you can design applications that use these libraries efficiently. For example, you would not initialize all local string variables to the NULL string and then redefine the string on first reference.

### **new/delete**

New C++ applications on z/OS often depend heavily on new and delete operators because they are commonly one of the first things taught in a C++ introductory course, and many courses never explicitly teach that classes can also be automatic (default for local) or global variables.

You should be aware that the new and delete operators are costlier to use than variables. Also, before using new, you should carefully consider:

- The scope/usage pattern of the variable
- Whether an automatic (local) or global variable is more appropriate

**Note:** You can ensure that all memory and storage requests are properly optimized by following the instructions given in Chapter 42, “Improving performance with compiler options,” on page 723 and “Optimizing memory and storage” on page 777.

---

## **Using explicit instantiation declarations (C++11 only)**

Use template explicit instantiation declarations to suppress implicit template instantiations. This helps reduce the collective size of the object files and shorten compiler time. This technique is described in “Using explicit instantiation declarations (C++11 only)” on page 462.

---

## **ANSI aliasing rules**

You must indicate whether your source code conforms to the ANSI aliasing rules when you use the IPA or the OPT(2) (or above) z/OS XL C/C++ compiler options. If the code does not conform to the rules, it must be compiled with NOANSIALIAS. Incorrect use of these options might generate bad code.

**Note:** The compiler expects that the source code conforms to the ANSI aliasing rules when the ANSIALIAS option is used. This option is on by default.

The ANSI aliasing rules are part of the ISO C Standard, and state that a pointer can be dereferenced only to an object of the same type or compatible type. Because the z/OS XL C/C++ compiler follows these rules during optimization, the developer must create code that conforms to the rules.

**Note:** The common coding practice of casting a pointer to an incompatible type and then dereferencing it violates ANSI aliasing rules. When you are using ANSI aliasing, you can cast an integer pointer only to the types described in Table 317 on page 698.

Table 317. Examples of acceptable alias types

Type	Reason for acceptance
int	This is the declared type of the object.
const int or volatile int	These types are the qualified version of the declared type of the object.
unsigned int	This is a signed or unsigned type corresponding to the declared type of the object.
const unsigned int or volatile unsigned int	These types are the signed or unsigned types corresponding to a qualified version of the declared type of the object.
struct foo { unsigned int bar; };	This is an aggregate or union type that includes one of the aforementioned types among its members. This can include, recursively, a member of a subaggregator-contained union.
char or unsigned char	The char pointers are an exception to the rules, as any pointer can be used to point to a char variable.

Conversely, your code breaks the aliasing rules if it casts a float to an int and then assigns it to the int pointer.

For more information, see type-based aliasing in *z/OS XL C/C++ Language Reference* and ANSIALIAS in *z/OS XL C/C++ User's Guide*.

You can cast and mix data types as long as you are careful how you intermix values and their pointers in your code. The compiler follows the ANSI aliasing rules to determine:

- Which variables must be stored into memory before you read a value through a pointer
- Which variables must be updated from memory after you have updated a value through a pointer

When you use the NOANSIALIAS option, the compiler generates code to accommodate worst-case assumptions (for example, that any variable could have been updated by the store through a pointer). This means that every variable (local and global) must be stored in memory to ensure that any value can be read through a pointer. This severely limits the potential for optimization.

```
int e1;
float ef1;
int *eip1;
float *efp1;

float exmp1 ()
{
    ef1 = 3.0;
    e1=5;
    *efp1 = ef1;
    *eip1 = e1;
    return *efp1;
}
```

Table 318 on page 699 shows the difference between code generated with, and without, ANSI aliasing.

Table 318. Comparison of code generated with the ANSIALIAS and NOANSIALIAS options

ANSIALIAS RENT and OPT(2)	NOANSIALIAS RENT and OPT(2)
<pre> * { *  ef1 = 3.0;   L   r4,=A(@CONSTANT_AREA)(,r3,94)   L   r2,=Q(EF1)(,r3,98)   LD  f0,+CONSTANT_AREA(,r4,0)   L   r14,_CEECAA_(,r12,500)   L   r15,=Q(EFP1)(,r3,102)   L   r4,=Q(EIP1)(,r3,106)   L   r1,#retvalptr_1(,r1,0)   STE f0,ef1(r2,r14,0)   L   r15,efp1(r15,r14,0)  *  eil=5;   L   r2,=Q(EI1)(,r3,110)   LA  r0,   L   r4,eip1(r4,r14,0)  *  *efp1 = ef1;   STE f0,(*)float(,r15,0)   ST  r0,eil(r2,r14,0)  *  *eip1 = eil;   ST  r0,(*)int(,r4,0)  *  return *efp1;   STD f0,#retval_1(,r1,0) * } </pre>	<pre> * { *  ef1 = 3.0;   L   r2,=A(@CONSTANT_AREA)(,r3,110)   L   r14,_CEECAA_(,r12,500)   L   r4,=Q(EF1)(,r3,114)   L   r15,=Q(EFP1)(,r3,118)   LD  f0,+CONSTANT_AREA(,r2,0)  *  eil=5;   L   r2,=Q(EI1)(,r3,122)   STE f0,ef1(r4,r14,0)  *  *efp1 = ef1;   L   r4,efp1(r15,r14,0)  *  *eip1 = eil;   L   r5,=Q(EIP1)(,r3,126)   LA  r0,5   ST  r0,eil(r2,r14,0)   STE f0,(*)float(,r4,0)   L   r4,eip1(r5,r14,0)   L   r0,eil(r2,r14,0)  *  return *efp1;   L   r1,#retvalptr_1(,r1,0)   ST  r0,(*)int(,r4,0)   L   r14,efp1(r15,r14,0)   SDR f0,f0   LE  f0,(*)float(,r14,0)   STD f0,#retval_1(,r1,0) * } </pre>
<ul style="list-style-type: none"> <li>• In the ANSIALIAS case: <ul style="list-style-type: none"> <li>– f0, loaded with 3.0, is used whenever referring to ef1 or efp1</li> <li>– r0 is loaded with the value of 5, which is used for ei and eip</li> </ul> </li> <li>• In the NOANSIALIAS case, the loads and stores are always done. This removes opportunities for optimizations. For example, if a + b + c were used instead of 3.0 and ef1, saving through the pointer might have updated a, b, or c, and therefore you cannot common at all, and many more reloads.</li> <li>• ANSIALIAS would not help if all the floats were also integers</li> <li>• There is a group of problems that occurs when the ANSIALIAS option is used to compile code that does not conform to ANSI-aliasing rules (for example, when it casts a variable to a non-ANSI-aliasing type and then assigns the address of the value to a pointer for later use). If the ANSIALIAS option is in effect (it is the default) when a value is used through a pointer, the compiler might not reload the pointer value when the original value is updated, and the value might be stale when it is read.</li> </ul>	

## Using ANSI aliasing rules

Your programs are likely to perform better if you follow these guidelines:

- Use ANSI aliasing whenever possible.
- Declare constant variables with `const`. This is particularly helpful when using the C++ compiler because if something is qualified as `const`, the compiler will not be forced to perform unnecessary reloads to see if the value has changed.

This can generate significantly faster code.

```
ggPoint3 operator*(const ggHAffineMatrix3 &m
, const ggPoint3 &p)
{
    return ggPoint3(
        m.e[0][0] * p.x() + m.e[0][1] * p.y() + m.e[0][2] * p.z() + m.e[0][3],
        m.e[1][0] * p.x() + m.e[1][1] * p.y() + m.e[1][2] * p.z() + m.e[1][3],
        m.e[2][0] * p.x() + m.e[2][1] * p.y() + m.e[2][2] * p.z() + m.e[2][3]
    );
}
```

- Whenever their values cannot change, qualify pointers and their targets as constants, ensuring that you mark the appropriate part as const.
  - If only the pointer is constant, you can use a statement that is similar to the following:

```
int * const i = p /* a constant pointer to an integer that may vary */
```

- If only the target is constant, use a statement similar to either of the following:

```
int const * i = p /* a variable pointer to a constant integer */
const int * i = p /* a variable pointer to a constant integer */
```

- If both the target integer and the pointer are constants, use a statement similar to either of the following:

```
const int * const i = &p; /* a constant pointer to a constant integer */
int const * const i = &p; /* a constant pointer to a constant integer */
```

- Use the ROCONST compiler option. The ROCONST option works with both C and C++. This option causes the compiler to treat variables that are defined as const as if they are read-only. In some cases, these variables will be stored in read-only memory. For more information, see “ROCONST” on page 727.
- *For global variables initialized to large read-only arrays or strings:* Use a #pragma variable to ensure that they are implemented as read-only csects. This prevents them from being initialized at load time.  
**Example:** For large initialized arrays  
# pragma variable (arrayname, norent)
- *In a read-only situation:* If you are using the value through a pointer, use a temporary automatic variable. The difference in the source code is significant, as shown in the following table:

Table 319. Example of using temporaries to remove aliasing effects

ANSIALIAS RENT and OPT(2)	NOANSIALIAS RENT and OPT(2)
<pre> ... while (hot_loop &lt; hot_loop_end) {     hot_loop = hot_loop + foo-&gt;increment;     fun[x] = hot_loop*foo-&gt;expansion; } </pre>	<pre> { ... increment = foo-&gt;increment; expansion = foo-&gt;expansion; while (hot_loop &lt; hot_loop_end) {     hot_loop = hot_loop + increment;     fun[x] = hot_loop*expansion; } } </pre>

## Using variables

When choosing variables and data structures for your application, keep the following guidelines in mind:

- Use local variables, preferably automatic variables, as often as possible.

The compiler can accurately analyze the use of local variables, while it has to make several worst-case assumptions about global variables, which hinders optimizations. For example, if you code a function that uses external variables, and calls several external functions, the compiler assumes that every call to an external function could change the value of every external variable.

- If none of the function calls affect the global variables being used and you have to read them frequently with function calls interspersed, copy the global variables to local variables and use these local variables to help the compiler perform optimizations that otherwise would not be done.

Using IPA can improve the performance of code written using global variables, because it coalesces global variables. IPA puts global variables into one or more structures and accesses them using offsets from the beginning of the structures. For more information, see “Using the IPA option” on page 732.

- If you need to share variables only between functions within the same compilation unit, use static variables instead of external variables. Because static variables are visible only in the current source file, they might not have to be reloaded if a call is made to a function in another source file.

Organize your source code so references to a given set of externally defined variables occur only in one source file, and then use static variables instead of external variables.

In a file with several related functions and static variables, the compiler can group the variables and functions together to improve locality of reference.

Use a local static variable instead of an external variable or a variable defined outside the scope of a function.

The `#pragma isolated_call` preprocessor directive can improve the runtime performance of optimized code by allowing the compiler to make fewer assumptions about the references to external and static variables. For more information, see `isolated_call` in *z/OS XL C/C++ Language Reference*.

Coalescing global variables causes variables that are frequently used together to be mapped close together in memory. This strategy improves performance in the same way that changing external variables to static variables does.

- Group external data into structures (all elements of an external structure use the same base address) or arrays wherever it makes sense to do so.



Before it can access an external variable, the compiler has to make an extra memory access to obtain the variable's address. The compiler removes extraneous address loads, but this means that the compiler has to use a register to keep the address.

Using many external variables simultaneously requires many registers, thereby causing spilling of registers to storage. If you group variables into structures then it can use a single variable to keep the base address of the structure and use offsets to access individual items. This reduces register pressure and improves overall performance, especially in programs compiled with the RENT option.

The compiler treats register variables the same way it treats automatic variables that do not have their addresses taken.

- Minimize the use of pointers.

Use of pointers inhibits most memory optimizations such as dead store elimination in C and C++.

You can improve the runtime performance of optimized code by using the z/OS C **#pragma disjoint** directive to list identifiers that do not share the same physical storage. A similar mechanism that can be used to improve runtime performance of optimized code includes using the C99 restrict qualifier for pointers feature. The restrict type qualifier indicates for the lifetime of the pointer, and only it or a value directly derived from it will be used to access the object to which it points. For more information, see **#pragma disjoint** and restrict type qualifier in *z/OS XL C/C++ Language Reference*.

---

## Passing function arguments

When writing code for optimization, it is usually better to pass a value as an argument to a function than to let the function take the value from a global variable. Global variables might have to be stored before a value is read from a pointer or before a function call is made. Global variables might have to be reloaded after function calls, or stored through a pointer. For more information, see "Using ANSI aliasing rules" on page 699 and "Using variables" on page 701.

The **#pragma isolated\_call** preprocessor directive lists functions that do not modify global storage. You can use it to improve the runtime performance of optimized code. For more information, see **isolated\_call** in *z/OS XL C/C++ Language Reference*.

Linkage convention or how arguments are passed is not specified in the C language, but is defined by the platform. Compilers in general follow the calling convention as described by the Application Binary Interface (ABI). An ABI can define more than one linkage due to performance considerations; for example, the XPLINK and non-XPLINK linkages on the z/OS platform. To correctly invoke a function, the arguments passed must match the parameters as defined in the function definition. For example, if you pass a pointer argument to a function expecting an integer, the code generated by the compiler for the call and for the function definition may not match (see the note at the end of this topic).

As the following example shows, you can declare a function without providing information about the number and types of its parameters.

```

int func();
...
int a;
func(a);
...
int func(p)
void *p;
{
    ...
}

```

Because the function declaration has no parameter information, the compiler is not required to diagnose parameter mismatch. You can call this function, passing it any number of arguments of any type, but the compilation will not be guaranteed to work if the function is not defined to receive the arguments as passed, due to differences in linkage conventions. In the worse case, when the z/OS XL C/C++ compiler attempts inlining of such ill-formed function calls, it may get into an unrecoverable condition and the compilation is halted.

To correct the situation, use the CHECKOUT(GEN) option to identify missing function declarations and non-prototype function declarators. Add or change the declarations to prototyped declarations, and proceed with compilation again. Should you receive diagnostic messages regarding incorrect function argument assignment, change the function call to pass the expected parameter type.

**Note:** Such a mismatch may sometimes turn out not to be an issue, depending on the ABI; for example, if the ABI happens to allow both pointers and integers passed using general purpose registers. Even in this case, there is no guarantee that the optimized code would work as expected due to ambiguous information received by the compiler.

---

## Coding expressions

When coding expressions, consider the following recommendations:

- When components of an expression are duplicate expressions, code them either at the left end of the expression or within parentheses, as shown in the following example.

```

a = b*(x*y*z);           /* Duplicates recognized */
c = x*y*z*d;
e = f + (x + y);
g = x + y + h;

a = b*x*y*z;           /* No duplicates recognized */
c = x*y*z*d;
e = f + x + y;
g = x + y + h;

```

The compiler can recognize  $x*y*z$  and  $x + y$  as duplicate expressions when they are coded in parentheses or coded at the left end of the expression.

It is the best practice to avoid using pointers as much as possible within high-usage or other performance-critical code.

**Note:** The compiler might not be able to optimize duplicate expressions if either of the following are true:

- The address of any of the variables is already taken

- Pointers are involved in the computation
- When components of an expression in a loop are constant, code the constant expressions either at the left end of the expression or within parentheses.  
The following example shows the difference in evaluation when c, d, and e are constant and v, w, and x are variable.

```
v*w*x*(c*d*e);      /* Constant expressions recognized */
c + d + e + v + w + x;

v*w*x*c*d*e;       /* Constant expressions not recognized */
v + w + x + c + d + e;
```

---

## Coding conversions

Avoid forcing the compiler to convert numbers between integer and floating-point internal representations. Conversions require several instructions, including some double-precision floating-point arithmetic. When you must use mixed-mode arithmetic, code the integral, floating-point, and decimal arithmetic in separate computations wherever possible. Figure 168 shows an example.

---

```
/* this example shows how numeric conversions are done */

int main(void)
{
    int i;
    float array[10]={1.0,2.0,3.0,4.0,5.0,6.0,7.0,8.0,9.0,10.0}
    float x = 1.0;
    for (i = 0; i < 10; i++)
    {
        array[i] = array[i]*x; /* No conversions needed */
        x = x + 1.0;
    }

    for (i = 1; i <= 9; i++)
        array[i] = array[i]*i; /* Conversions may be needed */

    return(0);
}
```

---

Figure 168. Numeric conversions example

---

## Arithmetical considerations

Wherever possible, use multiplication rather than division. For example,  
`x*(1.0/3.0); /* 1.0/3.0 is evaluated at compile time */`

produces faster code than:  
`x/3.0;`

If you divide many values by the same number in your code: Assign the divisor's reciprocal to a temporary variable and then multiply by that variable.

---

## Using loops and control constructs

For the for-loop index variable:

- Use a long type variable whenever possible. Under ILP32, long and int are equivalent, but long is better for portability to an LP64 environment.
- Use the auto or register storage class over the extern or static storage class.
- If you use an enum variable, expand the variable to be a fullword by using the ENUMSIZE compiler option or by placing a large defined value at the end of your enum variable, as follows:

```
enum animals {
    ant
    cat,
    dog,
    robin,
    last_animal = INT_MAX;
};
```

- Do not use the address operator (&) on the index.
- The index should not be a member of a union.

For if statements:

- Order the if conditions efficiently; put the most decisive tests first and the most expensive tests last.

By performing the most common tests first, you increase the efficiency of your code; fewer tests are required to meet the test conditions.

```
if (command.is_classg &&
    command.len == 6 &&
    !strcmp (command.str, "LOGON")) /* call to strcmp() most expensive */
    logon ();
```

---

## Choosing a data type

Use the int data type instead of char when performing arithmetic operations.

```
char_var += '0';
int_var += '0';          /* better */
```

A char type variable is efficient when you are:

- Assigning a literal to a char variable
- Comparing the variable with a char literal

For example:

```
char_var = 27;
if (char_var == 'D')
```

Table 320 on page 706 lists analogous data types and shows which data types are more expensive to reference.

Table 320. Referencing data types

More Expensive	Less Expensive
unsigned short	signed short (Although unsigned short is less expensive on many systems, the z/OS implementation of signed short is less expensive.)
signed char	unsigned char
long double	double
Longer decimal	Shorter decimal

For storage efficiency, the compiler packs enumeration variables in 1, 2 or 4 bytes, depending on the largest value of a constant. When performance is critical, expand the size to a fullword either by adding an enumeration constant with a large value or by specifying the ENUMSIZE compiler option. For example:

```
enum byte { land, sea, air, space };
enum word { low, medium, high, expand_to_fullword = INT_MAX };
```

Example that is equivalent to using the ENUMSIZE(INT) compiler option:

```
enum word { low, medium, high };
```

Fullword enumeration variables are preferred as function parameters.

For efficient use of extern variables:

- Place scalars ahead of arrays in extern struct.
- Copy heavily referenced scalars to auto or register variables (especially in a loop).

When using float:

- When passing variables of type float to a function, an implicit widening to double occurs (which takes time).
- On some machines divisions of type float are faster than those of type double.

When using bit fields, be aware that:

- Even though the compiler supports a bit field spanning more than 4 bytes, the cost of referencing it is higher.
- An unsigned bit field is preferred over a signed bit field.
- A bit field used to store integer values should have a length of 8, 16, or 24 bits and be on a byte boundary.

```
struct {    unsigned   xval  :8,
                xbool  :1,
                xmany  :6,
                xset   :1;
} b;

if (b.xval == 3)
:
if (b.xmany + 5 == x)    /* inefficient because it does not */
                        /* fall on a byte boundary          */
:
if (b.xbool)
:
```

## Using library extensions

Effective use of DLLs could improve the performance of your application if either of the following is true:

- The application relies on a `fetch()` or `system()` function to call programs in other modules.
- The application is overly large and there are some low-use or special-purpose routines that you can move to a DLL.

If you are using C, consider calling other C modules with `fetch()` or DLLs instead of `system()`. A `system()` call does full environment initialization and termination, but a fetched module and a DLL share the environment of the calling routine. If you are using C++, consider using DLLs.

Use of DLLs requires more overhead than use of statically-bound function calls. You can test your code to determine whether you can afford this extra overhead. First, write the code so that it can be built to implement either a single module or a DLL. Next build your application both ways, and time both applications to see if you can handle the difference in execution time. For best DLL performance, structure the code so that once a function in the DLL is called, it does all it needs to do in the DLL before it returns control to the caller.

You can also choose how to implement DLLs. If you are using C, you can choose between:

- The XPLINK compiler option
- The DLL compiler option (which is used with the NOXPLINK option)

**Note:** In C++, DLL is not an option, but a default. When you use the XPLINK option, the compiler loads and accesses DLLs faster than it would if you used the DLL option.

The following suggestions could improve the performance of the application:

- If you are using a particular DLL frequently across multiple address spaces, you can install the DLL in either the LPA/ELPA or the DLPA to avoid load overhead. When the DLL resides in a PDSE, the DLPA services should be used.
- When you are binding your code, specify both the RENT and the REUSE options. Otherwise, each load of a DLL results in a separately loaded DLL with its own writable static area.
- Group external variables into one external structure.

- When you are using z/OS UNIX, avoid unnecessary load attempts.  
z/OS Language Environment supports loading a DLL that resides in the UNIX file system or in a data set. However, the location from which it first tries to load the DLL varies, depending whether your application runs with the runtime option POSIX(ON) or POSIX(OFF).
  - If your application runs with POSIX(ON), z/OS Language Environment tries to load the DLL from the UNIX file system first. If you are doing an explicit DLL load using the `dllload()` function, you can avoid searching the UNIX file system directories. You can direct a DLL search to a data set by prefixing the DLL name with two slashes (`//`), as follows:  
`//MYDLL`
  - If your application runs with POSIX(OFF), z/OS Language Environment tries to load your DLL from a data set. Similarly, if you are loading your DLL with the `dllload()` function and your DLL is loading in UNIX file system, you can avoid the search of the data set by directing a DLL search to the UNIX file system. You can do so by prefixing the DLL name with a period and slash (`./`), as follows:  
`./mydll`

**Note:** DLL names are case sensitive in the UNIX file system.

- When you are using IPA, export only those subprograms (functions and C++ methods) or variables that you need for the interface to the final DLL.  
If you export subprograms or variables unnecessarily (for example, by using the EXPORTALL option), you severely limit IPA optimization. In this case, global variable coalescing and pruning of unreachable or 100% inlined code does not occur. Before it can be processed by IPA, DLLs must contain at least one subprogram. Any attempt to process a data-only DLL will result in a compilation error.
- The suboption NOCALLBACKANY of the compiler option DLL is more efficient than the CALLBACKANY suboption.  
The CALLBACKANY option calls a Language Environment routine at run time. This runtime service enables a C or C++ NOXPLINK DLL routine to call a C NOXPLINK NODLL routine, which use function pointers that point to actual function entry points rather than function descriptors.

**Note:** Compiling source with the DLL option will often cause a degradation in performance when compared against a statically bound application compiled without that option.

---

## Using #pragmas

Table 321 describes #pragmas that can affect performance. For information about using each pragma, see *z/OS XL C/C++ Language Reference*.

Table 321. Pragmas that affect performance

Name	Description
#pragma disjoint	Lists identifiers that do not share the same physical storage, which provides more opportunities for optimizations.
#pragma execution_frequency	Marks program source code that you expect will be either very frequently or very infrequently executed.
#pragma export	Selectively exports functions or variables from a DLL module. The EXPORTALL compiler option exports <i>all</i> functions or variables, which often results in larger modules and significantly increased WSA requirements.

Table 321. Pragmas that affect performance (continued)

Name	Description
#pragma inline (C only)	Together with the <code>INLINE</code> compiler option, ensures that frequently used functions are inlined. This directive is only supported in C; however, you can use the <code>inline</code> keyword in C++.
#pragma isolated_call	Lists functions that have no side effects (that do not modify global storage). This directive can improve the runtime performance of variables and storage by allowing the compiler to make fewer assumptions about whether external and static variables could be updated.
#pragma leaves	Specifies that a function never returns to the instruction following a call to that function. This directive provides information to the compiler that enables it to explore additional opportunities for optimization.
#pragma noinline	This directive can improve pipeline usage and allow more of the used routines to be inlined.
#pragma option_override	<p>Allows you to specify optimization options on a per-routine basis rather than on only a per-compilation basis. It enables you to specify which functions you do not want to optimize while compiling the rest of the program optimized. This directive helps you to isolate which function is causing problems under optimization.</p> <p>The <b>option_override</b> pragma can be also used to change the spill size for a function. If the compiler requests that you to increase the spill size for a specific function, you should use the <b>option_override</b> pragma instead of the <code>SPILL</code> compiler option, which increases the spill size for all functions in the compile unit and can have a negative performance impact on the generated code.</p> <p><b>Note:</b> The spill size should not be increased unless requested by a compiler message.</p>
#pragma reachable	Declares that the point in the program after the specified function can be the target of a branch from some unknown location. That is, you can reach the instruction after the specified function from a point in your program other than the return statement in the named function. This directive provides information to the compiler that enables it to explore additional opportunities for optimization.
#pragma strings	Indicates if strings should be placed in read-only memory or read/write memory. You can reduce the memory requirements for DLLs by specifying <b>#pragma strings(readonly)</b> , so that string literals are not placed in the writable static area. Alternatively, you can also use the <code>ROSTRING</code> compiler option (the default), which informs the compiler that string literals are read-only.
#pragma unroll	Informs the compiler how to perform loop unrolling on the loop body that immediately follows it. The directive works in conjunction with the <code>UNROLL</code> compiler option to provide you with some control over the application of this optimization technique. The pragma directive overrides the “UNROLL” on page 728 or <code>NOUNROLL</code> compiler option in effect for the designated loop.
#pragma variable	<p>Indicates if a named external object is used in reentrant or non-reentrant fashion. If an object is qualified as <code>RENT</code>, its references or its definition will be in the writable static area, which is in modifiable storage. If an object is qualified as <code>NORENT</code>, its references or its definition will be in the code area.</p> <p>You can reduce the memory requirements for DLLs by specifying <b>#pragma variable(var_name,NORENT)</b>, so that constant variables are not placed in the writable static area.</p> <p>Alternatively, you can use the <code>ROCONST</code> compiler option to inform the compiler that constant variables are not to be placed in the writable static area.</p>



---

## Using rvalue references (C++11)

**Note:** C++11 is a new version of the C++ programming language standard. IBM continues to develop and implement the features of the new standard. The implementation of the language level is based on IBM's interpretation of the standard. Until IBM's implementation of all the features of the C++11 standard is complete, including the support of a new C++ standard library, the implementation may change from release to release. IBM makes no attempt to maintain compatibility, in source, binary, or listings and other compiler interfaces, with earlier releases of IBM's implementation of the new features of the C++11 standard and therefore they should not be relied on as a stable programming interface.

In C++11, you can overload functions based on the value categories of arguments and similarly have lvalueness detected by template argument deduction. You can also have an rvalue bound to an rvalue reference and modify the rvalue through the reference. This enables a programming technique with which you can reuse the resources of expiring objects and therefore improve the performance of your libraries, especially if you use generic code with class types, for example, template data structures. Additionally, the value category can be considered when writing a forwarding function.

When you want to optimize the use of temporary values, you can use a move operation in what is known as destructive copying. Consider the following string concatenation and assignment:

```
std::string a, b, c;  
c = a + b;
```

In this program, the compiler first stores the result of `a + b` in an internal temporary variable, that is, an rvalue.

The signature of a normal copy assignment operator is as follows:

```
string& operator = (const string&)
```

With this copy assignment operator, the assignment consists of the following steps:

1. Copy the temporary variable into `C` using a deep-copy operation.
2. Discard the temporary variable.

Deep copying the temporary variable into `C` is not efficient because the temporary variable is discarded at the next step.

To avoid the needless duplication of the temporary variable, you can implement an assignment operator that moves the variable instead of copying the variable. That is, the argument of the operator is modified by the operation. A move operation is faster because it is done through pointer manipulation, but it requires a reference through which the source variable can be manipulated. However, `a + b` is a temporary value, which is not easily differentiated from a `const`-qualified value in C++ before C++11 for the purposes of overload resolution.

With rvalue references, you can create a move assignment operator as follows:

```
string& operator= (string&&)
```

With this move assignment operator, the memory allocated for the underlying C-style string in the result of `a + b` is assigned to `C`. Therefore, it is not necessary to allocate new memory to hold the underlying string in `C` and to copy the contents to the new memory.

The following code can be an implementation of the string move assignment operator:

```
string& string::operator=(string&& str)
{
    // The named rvalue reference str acts like an lvalue
    std::swap(_capacity, str._capacity);
    std::swap(_length, str._length);

    // char* _str points to a character array and is a
    // member variable of the string class
    std::swap(_str, str._str);
    return *this;
}
```

However, in this implementation, the memory originally held by the string being assigned to is not freed until `str` is destroyed. The following implementation that uses a local variable is more memory efficient:

```
string& string::operator=(string&& parm_str)
{
    // The named rvalue reference parm_str acts like an lvalue
    string sink_str;
    std::swap(sink_str, parm_str);
    std::swap(*this, sink_str);
    return *this;
}
```

In a similar manner, the following program is a possible implementation of a string concatenation operator:

```
string operator+(string&& a, const string& b)
{
    return std::move(a+=b);
}
```

**Note:** The `std::move`<sup>1</sup> function only casts the result of `a+=b` to an rvalue reference, without moving anything. The return value is constructed using a move constructor because the expression `std::move(a+=b)` is an rvalue. The relationship between a move constructor and a copy constructor is analogous to the relationship between a move assignment operator and a copy assignment operator.

The `std::forward`<sup>1</sup> function is a helper template, much like `std::move`. It returns a reference to its function argument, with the resulting value category determined by the template type argument. In an instantiation of a forwarding function template, the value category of an argument is encoded as part of the deduced type for the related template type parameter. The deduced type is passed to the `std::forward` function.

The wrapper function in the following example is a forwarding function template that forwards to the `do_work` function. Use `std::forward` in forwarding functions on the calls to the target functions. The following example also uses the `decltype` and trailing return type features to produce a forwarding function that forwards to one of the `do_work` functions. Calling the wrapper function with any argument results in a call to a `do_work` function if a suitable overload function exists. Extra temporaries are not created and overload resolution on the forwarding call resolves to the same overload as it would if the `do_work` function were called directly.

```
struct s1 *do_work(const int&);           // #1
struct s2 *do_work(const double&);      // #2
struct s3 *do_work(int&&);               // #3
struct s4 *do_work(double&&);           // #4
template <typename T> auto wrapper(T && a)->
```

```

decltype(do_work(std::forward<T>(*static_cast<typename std
::remove_reference<T>::type*>(0))))
{
    return do_work(std::forward<T>(a));
}
template <typename T> void tPtr(T *t);
int main()
{
    int x;
    double y;
    tPtr<s1>(wrapper(x));    // calls #1
    tPtr<s2>(wrapper(y));    // calls #2
    tPtr<s3>(wrapper(0));    // calls #3
    tPtr<s4>(wrapper(1.0)); // calls #4
}

```

**Note:**

1. The following sample implements functionality similar to `std::move` and `std::forward`:

```

namespace MyStd {
    template <typename T> struct remove_reference {
        typedef T type;
    };
    template <typename T> struct remove_reference<T&> {
        typedef T type;
    };
    template <typename T> struct remove_reference<T&&> {
        typedef T type;
    };
}

namespace Impl {
    template <typename T> struct NotAnLvalueReference {
        enum { value = 1 };
    };
    template <typename T> struct NotAnLvalueReference<T&> {
        enum { value = 0 };
    };
}

template <typename T> inline
T &&forward(typename remove_reference<T>::type &t) {
    return static_cast<T &&>(t);
}

template <typename T> inline
T &&forward(typename remove_reference<T>::type &&t) {
    static_assert(Impl::NotAnLvalueReference<T>::value,
        "T cannot be an lvalue reference type when
        calling this overload.");
    return static_cast<T &&>(t);
}

template <typename T> inline
typename remove_reference<T>::type &&move(T &&t) {
    return static_cast<typename remove_reference<T>::type &&>(t);
}
}

```

---

## Using shared-memory parallelism (SMP)

You can compile your program with the SMP option to generate threaded code that exploits shared-memory parallelism. The SMP option implies the HOT option and an optimization level of `OPTIMIZE(2)`.

The following table lists the suboptions of the SMP option. For descriptions and syntax of the suboptions, see the SMP option in *z/OS XL C/C++ User's Guide*.

*Table 322. SMP suboptions*

suboption	Behavior
EXPLICIT	Enables directives that control explicit parallelization of loops.
NOEXPLICIT	Disables the directives that control explicit parallelization of loops.
OPT	Instructs the compiler to optimize as well as parallelize. The optimization is equivalent to OPTIMIZE(2) and HOT in the absence of other optimization options.
NOOPT	Instructs the compiler to do the smallest amount of optimization that is required to parallelize the code. During development, it can be useful to turn off optimization to facilitate debugging.

## Tips for using the SMP option

Here are some suggestions for using the SMP option:

- Before using the SMP option, test your programs using OPTIMIZATION and HOT in a single-threaded manner.
- Use the thread-safe version of system library routines inside the parallel regions.
- By default, the runtime environment uses all available processors. Do not set the `OMP_NUM_THREADS` environment variable unless you want to use fewer than the number of available processors. You might want to set the number of executing threads to a small number or to 1 to ease debugging.
- When debugging an OpenMP program, try using SMP(NOOPT) (without OPTIMIZE) to make the debugging information produced by the compiler more precise.



---

## Chapter 40. Using built-in functions to improve performance

A built-in function is inline code that is generated in place of an actual function call.

The built-in functions described in this chapter behave exactly the same as those in the C library. The compiler will generate inline code for these functions if the appropriate header file is included in the source. For more information, see Built-in functions in *z/OS XL C/C++ Runtime Library Reference*.

If you have included the header files but you want to call either the library version of the function or your own version, enclose the function name in parentheses when you make the call. For example, if you wanted to call only `memcpy` from the header file and use the built-in functions for other memory-related functions, code the function call as follows:

```
(memcpy)(buf1, buf2, len)
```

*Table 323. C-library built-in functions*

Built-In Function	Header File
<code>abs()</code>	<code>stdlib.h</code>
<code>alloca()</code>	<code>stdlib.h</code>
<code>ceil()</code>	<code>math.h</code>
<code>ceilf()</code>	<code>math.h</code>
<code>ceill()</code>	<code>math.h</code>
<b>Note:</b> The compiler only attempts to generate inline code for <code>ceil()</code> , <code>ceilf()</code> , and <code>ceill()</code> when the <code>OPTIMIZE(2)</code> compiler option is used.	
<code>decabs()</code>	<code>decimal.h</code>
<code>decchk()</code>	<code>decimal.h</code>
<code>decfix()</code>	<code>decimal.h</code>
<code>fabs()</code>	<code>math.h</code>
<b>Note:</b> The compiler only attempts to generate inline code for <code>fabs()</code> when the <code>OPTIMIZE(2)</code> compiler option is used.	
<code>floor()</code>	<code>math.h</code>
<code>floorf()</code>	<code>math.h</code>
<code>floorl()</code>	<code>math.h</code>
<b>Note:</b> The compiler only attempts to generate inline code for <code>floor()</code> , <code>floorf()</code> , and <code>floorl()</code> when the <code>OPTIMIZE(2)</code> compiler option is used.	
<code>fortrc()</code>	<code>stdlib.h</code>
<code>memchr()</code>	<code>string.h</code>
<code>memcpy()</code>	<code>string.h</code>
<code>memcmp()</code>	<code>string.h</code>
<code>memset()</code>	<code>string.h</code>
<code>strcat()</code>	<code>string.h</code>
<code>strchr()</code>	<code>string.h</code>
<code>strcmp()</code>	<code>string.h</code>

Table 323. C-library built-in functions (continued)

Built-In Function	Header File
strcpy()	string.h
strlen()	string.h
strncat()	string.h
strncmp()	string.h
strncpy()	string.h
strrchr()	string.h
wmemchr()	wchar.h
wmemcmp()	wchar.h
wmemcpy()	wchar.h
wmemset()	wchar.h

**Note:** The compiler only attempts to generate inline code for `wmemchr()`, `wmemcmp()`, `wmemcpy()`, and `wmemset()` when the ARCH(7) compiler option is used. LP64 compiles will not generate inline code.

## \_\_builtin\_expect

You can use the `__builtin_expect` built-in function to indicate that an expression is likely to evaluate to a specified value. The compiler can use this knowledge to direct optimizations. This built-in function is portable with the GNU C/C++ `__builtin_expect` function.

The prototype of this built-in function is as follows:

```
long __builtin_expect (long exp, long c);
```

where `exp` is the integral-type expression to be evaluated and `c` is the expected value of the expression.

If `exp` does not actually evaluate at run time to the predicted value `c`, performance might suffer. Therefore, you must use this built-in function with caution.

## Platform-specific functions

The built-in functions in this section are related to C-library functions that are z/OS specific. The full description of each function can be found in *z/OS XL C/C++ Runtime Library Reference*.

Table 324. Platform-specific built-in functions

Built-In Function	Header File
<code>cds()</code>	<code>stdlib.h</code>
<code>cs()</code>	<code>stdlib.h</code>

**Note:** `cds()` and `cs()` are masking macros. The system header expands them to the `__cds` and `__cs`. It is advisable to use the hardware functions instead of the library functions whenever possible. For more information, see Table 89 on page 505.

## Examples

- You can use the following macros rather than their equivalent functions, if you include the `ctype.h` header file.

<code>isalpha()</code>	<code>isalnum()</code>	<code>islower()</code>	<code>isprint()</code>	<code>isupper()</code>	<code>isxdigit()</code>
<code>iscntrl()</code>		<code>ispunct()</code>		<code>toupper()</code>	
<code>isdigit()</code>		<code>isspace()</code>		<code>tolower()</code>	
<code>isgraph()</code>					

- If you are using the `__cs1` or `__cds1` function with arguments other than the ones declared in the prototypes in `stdlib.h`, the compiler might not be able to generate correct code at OPT. In this case, use the `NOANSIALIAS` option.

**Note:** As of z/OS V1R2, the new forms for `cs()` and `cds()` are `__cs1` and `__cds1`, respectively. For more information, see Chapter 33, “Using hardware built-in functions,” on page 505.

- Typically, arrays are compared element-by-element, using a loop. When you compare two arrays for equality, replace the loop with the `memcmp()` library function. This could result in the execution of many machine instructions being replaced by the execution of a only a few machine instructions.

More efficient comparison with <code>memcmp()</code> library function	Less efficient comparison in a loop
<pre>if (!memcmp (a, b, sizeof(a)))     /* arrays are equal */</pre>	<pre>int a[1000], b[1000];  for (i = 0; i &lt; 1000; ++i)     if (a[i] != b[i])         break;  if (i == 1000)     /* arrays are equal */</pre>

- Neither the C nor the C++ language allows structure comparison, because structures might contain padding bytes with undefined values. In cases where you know that no padding bytes exist, use `memcmp()` to compare structures. The z/OS AGGREGATE compiler option for C is used to obtain a structure and union map.
- The `memset()` library function should be used to initialize a character buffer and to initialize an array to a repetitive byte pattern (such as zeros).
- Use `memset()` to clear structs, unions, arrays or character buffers as follows:

```
char c[10];

for (i = 0; i < 10; i++)
    c[i] = ' ';
/* do not use */

memset (c, ' ', sizeof (c));
/* better */
```

- Use the `alloca()` function to automatically allocate memory from the stack. This function frees memory at the end of a function call when z/OS XL C/C++ collapses the stack. For more information, see `alloca` in *z/OS XL C/C++ Runtime Library Reference*.
- When using `strlen()`, do not hide size information. Less code is needed for `strlen()` when the upper bound is known at compile time.



```

char    small_str_array[100];
char    *small_str_ptr;
:
:
x = strlen(small_str_ptr); /* unknown upper bound */
x = strlen(small_str_array); /* better */

```

- When concatenating strings, use `strcat()`.
- When performing character-to-integer conversions, use `atoi()` rather than `sscanf()`.
- Whenever possible, replace `strxxx()` functions with their corresponding `memxxx()` functions, because `memxxx()` functions are more efficient. You can minimize the execution cost of a `strxxx()` function by using fixed-length character buffers to save the length of incoming strings (including null terminators) for subsequent calls to `memcpy()` and `memcmp()`.

```

total_len = strlen (s) + 1;
:
:
for (i = 0; i < 10; i++)
    if (memcmp (s, t[i], total_len) == 0) /* total_len ≤ sizeof(t) */
        :
:
memcpy (a, s, total_len);

```

If you try to replace all `strcmp()` calls with a `memcmp()` call taking a `strlen()` value of one of the strings, the result might be an attempt to access protected storage which follows the shorter string. Such an attempt could cause an exception because `memcmp()` does not stop comparing strings when it encounters a null in one of the strings.

- Whenever possible, replace `wcsxxx()` functions with their corresponding `wmemxxx()` functions, because `wmemxxx()` functions are more efficient. You can minimize the execution cost of a `wcsxxx()` function by using fixed-length wide character buffers to save the length of incoming wide character strings (including null terminators) for subsequent calls to `wmemcpy()` and `wmemcmp()`.

---

## Chapter 41. I/O Performance considerations

This chapter discusses the most efficient use of the available XL C/C++ input and output methods. This includes:

- “Accessing MVS data sets”
- “Accessing UNIX file system files” on page 721
- “Using memory files” on page 721
- “Using the C++ I/O stream libraries” on page 721

---

### Accessing MVS data sets

- Consider the use of the file when choosing DCB parameters:
  - Specify largest possible BLKSIZE (blocked files).
  - Use `recfm = FBS` or `F` over `FB` unless dealing with a PDS. The use of standard (S) blocks optimizes the sequential processing of a file on a direct-access device.
  - `fseek()` on sequential files is most efficient when using `recfm = F` or `recfm = FBS`.
  - If you are accessing an existing sequential file created as `FB`, and you know that there are no short blocks in the file, specify `FBS` on the call to `fopen()` or `freopen()` to enable the library to perform faster repositions.

The proper choice of file attributes is important for efficient I/O.

- When you do not need to reposition within a file, take advantage of `NOSEEK` for more efficient reading and writing to a data set. You can also specify `NCP` or `BUFNO` on the DD statement for MVS DASD data sets, thereby reducing the clock time of the application. See “Multiple buffering” on page 102 for more information.
- If possible, read or write a block at a time to minimize the I/O overhead and elapsed time.
- Using text I/O for writing can be slower than using binary or record I/O. When you use binary or record I/O, the application must ensure that the data is written to the file in the correct format.
- If you are using `FB` or `FBS` files, use binary I/O instead of record I/O. This way, you can read or write more than one record at a time.
- Use `fread()` instead of `fgets()`, and `fwrite()` in place of `fputs()`, wherever possible.
- Use `putc()` instead of `fputc()`, and `getc()` instead of `fgetc()`, if you must read or write a character.

The `fputc()` function, as defined by ANSI, puts a single character to the text stream. Special action occurs when writing a control character. On the other hand, the `putc()` macro buffers characters in storage and invokes `fputc()` only when encountering a control character. This reduces call overhead when you are writing one character at a time.

- If you are using hyperspace memory files, you can use `setvbuf()` to set the buffer size.

The default buffer size for memory files in hyperspace is 16K. You can override this by calling `setvbuf()` after `fopen()`, but before performing any I/O

operations on the file. The minimum buffer size is 4K. If you specify a smaller size, it is ignored, and the default is used instead.

If your file will be large, you can improve execution time by increasing the buffer size. This will result in less frequent flushing of the buffer to the hiperspace, but will cost you memory in the user address space for the larger buffers. For example,

```
rc = setvbuf(fp, NULL, _IOFBF, 32768);
```

Alternatively, if your memory is constrained, you can reduce requirements for memory in the user address space by reducing the buffer size. This will result in more frequent flushing of the buffer to the hiperspace. For example,

```
rc = setvbuf(fp, NULL, _IOFBF, 4096);
```

For more information on hiperspace memory files, refer to Chapter 14, "Performing memory file and hiperspace I/O operations," on page 201.

- When writing to text files that do not use DBCS characters, ensure that `MB_CUR_MAX` is set to 1 for the current locale. This will prevent internal I/O checks for DBCS strings.
- Avoid using `fscanf()` or `fprintf()` if you can use other I/O routines instead. For example, use `fwrite()` rather than `fprintf()` to write out a format string with no substitution variables.
- When using `fflush()` beware of NULL file pointers; `fflush(NULL)` flushes all open streams.
- Specify DCB parameters on `fopen()` only when you are creating the file. When you are appending, updating or reading a file, these attributes are retrieved from the existing file.

Many file attributes (DCB parameters) are possible when you open a file with z/OS XL C/C++. DCB parameters specified on `fopen()` must be compatible with those of the file or the `ddname`. This checking may cause unwanted overhead.

- Use `fgetpos()` and `fsetpos()` instead of `ftell()` and `fseek()` when you are saving a position you will return to later. `fgetpos()` saves more information about the position than `ftell()`.
- Where possible, use striped data sets. These data sets improve overall I/O throughput.
- For temporary files, use memory files rather than files created with `tmpfile()`. You can use MVS memory files from z/OS UNIX C++ application programs. However, use of the `fork()` function from the program clears a memory file and removes access from a hiperspace memory file for the child process. Use of an `exec` function from the program clears a memory file when the process address space is cleared.
- For large memory files (1MB or larger) in which you perform random seeking, use hiperspace memory files, if they are available.
- When your library is below the 16MB line, use hiperspace memory files. The non-hiperspace files use up your storage from below the line. Hiperspace memory files do not reside in user virtual storage. Changing a memory file to a hiperspace memory file saves user virtual storage only if the file is larger than one hiperspace memory file buffer.
- For VSAM I/O use VSAM buffers appropriately and use `flocate()` instead of `ftell()` and `fseek()`.

---

## Accessing UNIX file system files

When accessing UNIX file system files, you should review the following considerations:

- Use `fread()` instead of `fgets()`, and `fwrite()` in place of `fputs()`, wherever possible.
- Use `putc()` instead of `fputc()`, and `getc()` instead of `fgetc()`, if you must write or read a character.
- When using `fflush()`, beware of NULL file pointers; `fflush(NULL)` flushes all open streams.
- Changing the buffer size for access to UNIX file system may provide advantages. Rather than using the default of 4K, you may want to use the `setvbuf()` function to set the buffer size to be the length of the read or write operation that you normally do.

For example, in applications that access files in a z/OS File System (zFS) file system, the recommended `setvbuf()` buffer size is 64K.

When you include the header file `stdio.h`, macros are defined for `getc()`, `putc()`, `getchar()`, and `putchar()`. To use the function calls instead of the macro calls, use `#undef` after the `stdio.h` header file is included. If you are working with a threaded application, these macros are automatically undefined forcing the application to use function calls, which are thread safe. The feature test macro `_ALL_SOURCE` causes these four macros to be undefined. However, if you require `_ALL_SOURCE`, and want these macros to be used in a non multi-threaded application, you can use feature test macro `_ALL_SOURCE_NOTHREADS`.

---

## Using memory files

Use memory files as efficient temporary files by specifying the `type=memory` attribute in `fopen()` before creating the temporary file. Some applications use temporary files to pass data between program modules.

When using one of the z/OS UNIX shells, an MVS memory file may or may not make an efficient temporary file. This depends on whether your z/OS UNIX XL C/C++ application program uses `fork()` and `exec()` functions to call another program to run in a child process. The child process does not inherit MVS memory files after an `exec()` function. For more information, see “Accessing MVS data sets” on page 719.

---

## Using the C++ I/O stream libraries

The following information applies to the USL I/O Stream Class Library and to the Standard C++ I/O stream classes.

- Unit-buffering incurs a significant performance penalty. Unit-buffering can be enabled by setting the `ios::unitbuf` flag. It is enabled for the `cerr` object by default.
- The `sync_with_stdio()` function enables unit-buffering of standard streams, to ensure their synchronization with C standard streams. However, a runtime performance penalty is incurred to ensure this synchronization. For more information about `sync_with_stdio()`, see Chapter 4, “Using the Standard C++ Library I/O Stream Classes,” on page 23.
- In most cases, calls to functions in the USL or ANSI C++ I/O stream libraries are mapped to calls to the I/O functions of the C standard library. For this reason, direct calls to the C I/O functions are recommended for applications that must

have the best possible performance. This does not mean that these types of applications cannot or should not contain any `iostream.h` calls. However, you might want to ensure that `iostream.h` I/O calls do not appear on the critical path; it is safe to keep them for unused debugging code.

**Note:** If you access the same file with both C and C++ I/O stream classes, undefined results will occur.

---

## Chapter 42. Improving performance with compiler options

This information discusses and lists the z/OS XL C/C++ compiler options that you can use to improve application performance. The information includes the following topics:

- “Using the OPTIMIZE option”
- “Optimizations performed by the compiler”
- “Additional options that affect performance” on page 725
- “Inlining” on page 728
- “Using the XPLINK option” on page 731
- “Using the IPA option” on page 732

---

### Using the OPTIMIZE option

During optimization, the compiler changes the unoptimized code sequences, derived from the source code, into equivalent code sequences that execute faster and usually require less memory space. It is also possible for an expression that would normally cause an exception to be removed by optimization, thus preventing the exception.

**Note:** You can optimize code by specifying either OPTIMIZE(2) or OPTIMIZE(3). Optimized code takes significantly more time to compile than unoptimized code, but will likely result in faster-running code. There is no guarantee that the compile time at OPTIMIZE(3) will remain similar from release to release.

Because the optimization is achieved by transforming the code using knowledge obtained from a larger program context, the direct correspondence between source and object code is often lost. Optimized code is also more sensitive to subtle coding errors.

One example of a subtle coding error is to type cast a pointer variable incorrectly. The compiler assumes ISO conformance when doing optimization. If your program does not conform, you may receive undefined results. For more information, see “ANSI aliasing rules” on page 697 and “Using ANSI aliasing rules” on page 699.

---

### Optimizations performed by the compiler

The compiler performs several optimizations, including:

#### Inlining

Inlining replaces certain function calls with the actual code of the function being performed. For more information on inlining, see “Inlining” on page 728.

For z/OS XL C/C++, automatic inlining is performed by default when you specify OPTIMIZE. You can override this inlining by using the NOINLINE option. For more information, see INLINE in *z/OS XL C/C++ User's Guide*.

#### Value numbering

Value numbering involves local constant propagation, local expression elimination, and folding several instructions into a single instruction.

### **Straightening**

Straightening is rearranging the program code to minimize branching logic and to combine physically separate blocks of code.

### **Common expression elimination**

Common expressions recalculate the same value in a subsequent expression. The duplicate expression can be eliminated by using the previous value. This is done even for intermediate expressions within expressions.

If your program contains the following statements, the common expression  $c + d$  is saved from its first evaluation and is used in the subsequent statement to determine the value of  $f$ .

```
a = c + d;  
.  
.  
.  
f = c + d + e;
```

### **Code motion**

If variables used in a computation within a loop are not altered within the loop, it may be possible to perform the calculation outside of the loop and use the results within the loop.

### **Strength reduction**

Less efficient instructions are replaced with more efficient ones. For example, in array addressing, an add instruction replaces a multiply.

### **Constant propagation**

Constants used in an expression are combined and new ones generated. Some mode conversions are done, and compile-time evaluation of some intrinsic functions takes place.

### **Instruction scheduling**

Instructions are reordered to minimize execution time.

### **Dead store elimination**

The compiler eliminates stores when the value stored is never referred to again. For example, if two stores to the same location have no intervening load, the first store is unnecessary, and is therefore removed.

### **Dead code elimination**

The compiler may eliminate code for calculations that are not required. Other optimization techniques may cause code to become dead.

### **Graph coloring register allocation**

The compiler uses a global register allocation for the whole function, thereby allowing variables to be kept in registers rather than in memory.

These optimization techniques may be performed both locally and globally. Increases in storage and compile time requirements over NOOPT will occur. Higher levels of optimization may perform the same options more rigorously as well as adding additional options.

## **Aggressive optimizations with OPTIMIZE(3)**

The compiler optimizes more aggressively with OPTIMIZE(3) than with OPTIMIZE(2). Code may be moved, and computations may be scheduled, even if this could potentially raise an exception.

OPTIMIZE(3) may place instructions onto execution paths where they will be executed when they may not have been according to the actual semantics of the program. For example, a loop-invariant floating-point computation that is found on some, but not all, paths through a loop will not be moved using OPTIMIZE(2) because the computation may cause an exception. For OPTIMIZE(3), the compiler will move the computation because it is not certain to cause an exception.

The same is true for moving loads. Although a load through a pointer is never moved, loads off the static or stack base register are considered movable using OPTIMIZE(3). Loads in general are not considered to be absolutely safe using OPTIMIZE(2) because a program can contain a declaration of a static array `a` of 10 elements and load `a[600000000003]`, which could cause a segmentation violation.

The same concepts apply to scheduling. In Figure 169, using OPTIMIZE(2), the computation of `b+c` is not moved out of the loop for two reasons:

- It is considered dangerous because it is a floating-point operation
- It does not occur on every path through the loop

---

```
⋮
int i;
float a[100], b, c;
for (i=0; i < 100; i++)
{
    if (a[i] < a[i+11])
        a[i] = b + c;
}
⋮
```

---

Figure 169. Example of using OPTIMIZE(2)

At OPTIMIZE(3), the computation `b + c` is moved out of the loop.

---

## Additional options that affect performance

The following topics describe compiler options that affect performance. For more information, see compiler options in *z/OS XL C/C++ User's Guide*.

### ANSIALIAS

The ANSIALIAS option specifies whether type-based aliasing is to be used during optimization. Type-based aliasing will improve optimization. For more information about ANSI aliasing, see “ANSI aliasing rules” on page 697 and “Using ANSI aliasing rules” on page 699.

### ARCHITECTURE and TUNE

The ARCHITECTURE option specifies the architectural level for which the executable program's instructions will be generated. The TUNE option specifies for which architectural level the executable program will be optimized.

ARCHITECTURE allows the compiler to take advantage of specific hardware instruction sets. TUNE allows the compiler to take advantage of differences (such as scheduling of instructions) in architectural levels.



## ASSERT(RESTRICT)

The ASSERT(RESTRICT) option enables optimizations for restrict qualified pointers.

## COMPRESS

Use the COMPRESS option to suppress the generation of function names in the function control block to reduce the size of your application's load module. The amount of reduction depends on the average function size in the application, as compared to the length of the function name.

## COMPACT

When the COMPACT option is active, the compiler favors optimizations that tend to limit the growth of the code. Depending on your specific program, the object size may increase or decrease and the execution time may increase or decrease. Any time you change your program, or change the release of the compiler, you should re-evaluate your use of the COMPACT option.

## CVFT (C++ only)

Use the NOCVFT option to reduce the size of the writable static area for constructors that call virtual functions within the class hierarchy where virtual inheritance is used.

## EXH (C++ only)

You might improve the run time of your C++ code by using NOEXH. The resultant code will run faster, but it will not be ISO-compliant if the program uses exception handling.

## EXPORTALL

Use the EXPORTALL option only if you want to export all external functions and variables in the source file so that a DLL application can use them. If you only need to export some externally defined functions and variables, use the **#pragma export** directive or the `_Export` C++ keyword instead of EXPORTALL.

If you use EXPORTALL, you can severely limit IPA optimization, and can cause your modules and WSA to be larger than necessary.

## HGPR

The HGPR option enables the compiler to exploit 64-bit General Purpose Registers (GPRs) in 32-bit programs targeting z/Architecture hardware.

## HOT

The HOT compiler option enables the compiler to request high-order transformations on loops during optimization, which gives you the ability to generate more highly optimized code.

## IGNERRNO

The IGNERRNO option informs the compiler that the program is not using errno. This allows the compiler more freedom to explore optimization opportunities for certain library functions (for example, sqrt). You need to include the system header files to get the full benefit of the IGNERRNO option.

## IPA

The IPA option specifies that the compiler should use interprocedural analysis when optimizing this module. This can lead to significant performance improvements. For more information, see “Using the IPA option” on page 732.

## LIBANSI

The LIBANSI option specifies whether or not all functions with the name of an ANSI C library function are in fact the ANSI functions. This allows the compiler to generate code based on existing knowledge concerning the behavior of the function. For example, the compiler will determine whether any side effects are associated with a particular library function. LIBANSI can provide additional benefits when used in conjunction with IGNERRNO.

## OBJECTMODEL (C++ only)

You can compile your programs using two different object models. They differ in the following areas:

- Layout for the virtual function table
- Name mangling scheme

The OBJECTMODEL compiler option has the following suboptions to set the type of object model:

### CLASSIC

uses the original object model that was available on all previous releases of C++ compiler.

### IBM

uses the new object model and should be selected if you want improved performance. This is especially true for class hierarchies with many virtual base classes. The size of the derived class is considerably smaller and access to the virtual function table is faster.

All classes in the same inheritance hierarchy must have the same object model.

Use the `#pragma object_model` directive to specify an object model in your source. For more information, see `object_model` in *z/OS XL C/C++ Language Reference*.

## PREFETCH

The PREFETCH option inserts prefetch instructions automatically where there are opportunities to improve code performance.

## RESTRICT

The RESTRICT option indicates to the compiler that all pointer parameters in some or all functions are disjoint.

## ROCONST

The ROCONST option specifies that the `const` qualifier is respected by the program. Variables that are defined with the `const` keyword are not overridden by a casting operation. When you use this option in C with the DLL option, you must ensure that no `const` global variables (static or external) are initialized with the address of an entity from another compile unit.

## ROSTRING

The ROSTRING option specifies that strings are placed in read-only memory. It has the same effect as the `#pragma strings(readonly)` directive.

## RTTI

If you are not using RTTI/dynamic casts in your program, compile with the NORTTI option.

## SPILL

When you specify a very large spill size, you can force the compiler to generate less than optimal code. For this reason, you might not want to specify the large spill size for an entire application. For example, either you can specify the large spill size for only the specific compilation unit that needs it or you can use the `#pragma option_override` directive.

## STRICT

The STRICT option prevents optimizations done by default at optimization levels OPT(3), and optionally at OPT(2), from re-ordering instructions that could introduce rounding errors.

## STRICT\_INDUCTION

With strict induction, induction (loop counter) variables are not optimized. This guards against problems that can occur if an optimized induction variable overflows.

If it is certain that the induction variables will not overflow, use the NOSTRICT\_INDUCTION option. This option can improve the performance of induction variables that are smaller than the register size on the processor.

## THREADED

The THREADED option indicates to the compiler whether it must generate threadsafe code.

## UNROLL

The UNROLL option gives the user the ability to control the amount of loop unrolling done by the compiler. Loop unrolling exposes instruction level parallelism for instruction scheduling and software pipelining and thus can improve a program's performance. It should be used in conjunction with `#pragma unroll`.

---

## Inlining

Inlining replaces certain function calls with the actual code of the function and is performed before all other optimizations. Not only does inlining eliminate the linkage overhead, it also exposes the entire called function to the caller, which enables the compiler to better optimize your code.

**Note:** See "Inlining under IPA" on page 731 for information on differences in inlining under IPA.

The following types of calls are not inlined:

- A call where the number of parameters on the call does not match that on the function definition. An example of this is a variable argument function call.
- A call that is directly recursive; the routine calls itself.
- K&R style var\_arg functions.

Consider the C examples CCNGOP1 and CCNGOP2, shown in Table 325. CCNGOP1 specifies the **#pragma inline** directive for the function which\_group(). If you use the OPTIMIZE option when you compile CCNGOP1, the compiler determines that CCNGOP1 is equivalent to CCNGOP2.

Table 325. Examples of optimization

Sample program CCNGOP1	Sample program CCNGOP2
<pre> /* this example demonstrates optimization */  #include &lt;stdio.h&gt; #pragma inline (which_group) int which_group (int a) {     if (a &lt; 0) {         printf("first group\n");         return(99);     }     else if (a == 0) {         printf("second group\n");         return(88);     }     else {         printf("third group\n");         return(77);     } }  int main (void) {     int j;      j = which_group (7);      return(j); } </pre>	<pre> /* this example also demonstrates optimization */  #include &lt;stdio.h&gt;  int main(void) {      printf("third group\n"); /* a lot less code                              generation */      return(77); } </pre>

## Selectively marking code to inline

The z/OS XL C/C++ inliner supports two modes of running: selective and automatic.

Selective mode enables you to specify, in your source code, the functions that you do, and do not, want inlined.

If you know which functions are frequently invoked from within a compilation unit, you can mark them for inlining:

- For a C program, add the appropriate **#pragma inline** directives in your source and compile with `INLINE (NOAUTO,REPORT,,)`.
- For a C++ program, add `inline` keywords to your source and compile with `INLINE (NOAUTO,REPORT,,)`.
- You can also use the `always_inline` function attribute to inline a function, regardless of whether optimization was specified at compile time.

If your code contains complex macros, the macros can be made into static routines that are marked to be inlined at no execution-time cost. All static routines that are interfaces to a data object can be placed in a header file.

## Automatically choosing functions to inline

Automatic mode assists you with starting to optimize your code. It allows the compiler to choose potential functions to inline. The compiler will inline all routines that are less than the *threshold* in abstract code units (ACUs) until the function that the functions are inlined into is greater than *limit* abstract code units. The *threshold* and *limit* parameters are defined as follows:

### *threshold*

Maximum relative size of a function to inline. The default value is 100 Abstract Code Units (ACUs), both for C and C++. ACUs are proportional in size to the executable code in the function; your code is translated into ACUs by the compiler. Specifying a threshold of 0 is equivalent to specifying NOAUTO. Note that the proportion of ACUs to executable code in a function is different under IPA.

*limit* Maximum relative size a function can grow before auto-inlining stops. The default is 1000 ACUs for the specific function. Specifying a limit of 0 is equivalent to specifying NOAUTO.

**Note:** When functions become too large, runtime performance can degrade.

Under the z/OS UNIX shell, to provide assistance in choosing which routines to inline, use the **c89 -W** command to pass the INLRPT option to the z/OS XL C/C++ compiler. At NOOPT, you will also need to specify the INLINE option. The default at NOOPT is NOINLINE.

For example, at NOOPT, to get INLINE(AUTO,REPORT,100,1000) for a C program, use one of the following c89 commands:

```
c89 -W "0,inline(,REPORT,,)" example.c
c89 -W "0,inline,inlrpt" example.c
```

You can get the same value at OPT for a C program passing the INLRPT option to the z/OS XL C/C++ compiler as follows:

```
c89 -2 -W "0,inlrpt"
```

**Note:** Inlining debugging functions or functions that are rarely invoked can degrade performance. Use the **#pragma noinline** directive to instruct the automatic inliner to not inline these types of functions. The **#pragma inline** and the **#pragma noinline** directives and the inline keyword are honored by automatic inlining regardless of the *limit* and *threshold* you have specified. For more information, see inline in *z/OS XL C/C++ Language Reference*.

## Modifying automatic inlining choices

While automatic inlining is the best choice the compiler can make for you, you can further improve your performance. Use **#pragma inline** and **#pragma noinline** to reduce the need to modify your inlining choices when you change your application. You may want to wait until you have a stable application before you do the following steps.

1. Compile with the OPTIMIZE option and ask for a report from the inliner by specifying the compiler options INLINE(,REPORT,,) or INLRPT and OPTIMIZE.

2. Look at the report to see if anything was inlined that should not have been; for example, routines for debugging or handling exceptions. Add **#pragma noinline** to your source to insure that these functions do not get inlined.
3. Add the `inline` keyword (for C++) or the **#pragma inline** directive (for C) to any frequently used routines to ensure that it gets inlined.
4. Recompile with `OPTIMIZE` then, regenerate the inline report and reanalyze for functions that should and should not be inlined.
5. You should also vary the limit and threshold values.
  - The inline report tells you the abstract code units (ACUs) for each function. These should help you determine an appropriate *threshold* to start from. In general, your initial *threshold* should be as small as possible, and your initial limit should be in the 1000 to 2000 range.
  - Increase the *threshold* by an increment small enough to catch a few more routines each time.
  - Change the limit when you wish. Because performance will improve as a function of both the `limit` and the `threshold` values, it is not recommended that you change both `limit` and `threshold` at the same time.
6. Repeat the process until you feel that you have found the best performance parameters. You should run your application to determine if the tuning has found the best performance parameters.
7. When you are satisfied with the selection of inlined routines, add the appropriate **#pragma inline** directives or `inline` keywords to the source. That is, when the selected routines are forced with these directives, you can then compile the program in selective mode. This way, you do not need to be affected by changes made to the heuristics used in the automatic inliner.

## Overriding inlining defaults

Automatic and selective inlining are performed when the `OPTIMIZE` compiler option is specified. You can override this by specifying the `NOINLINE` option when you specify your optimization level. You can also override this by specifying the **#pragma noinline** directive for a particular function. For more information, see **inline** in *z/OS XL C/C++ Language Reference*.

## Inlining under IPA

The IPA Inliner functions differently from the regular inliner:

- It performs inlining across compilation units, rather than within a compilation unit.
- It handles inlining of functions with variable argument lists.
- It inlines calls from recursive cycles (for example, where function A calls function B calls function C calls function A). However, it avoids making the functions too large.

For more information about IPA, see “Using the IPA option” on page 732.

---

## Using the XPLINK option

Applications that make many calls to small functions get the most benefit from using XPLINK. Many C++ applications are structured this way, because of the object oriented programming model. C applications that make many function calls may also be suitable for XPLINK.

## When you should not use XPLINK

Functions compiled XPLINK and NOXPLINK cannot be combined in the same program object.

XPLINK provides a significant performance enhancement to some applications, but can degrade the performance of applications that are not suitable for XPLINK.

Another way to call an XPLINK function from a non-XPLINK program object is to use the DLL call mechanism. There is an overhead cost associated with calls made from non-XPLINK to XPLINK, and from XPLINK to non-XPLINK. This overhead includes the need to swap from one stack type to another and to convert the passed parameters to the style accepted by the callee. Applications that make a large number of these "cross-linkage" calls may lose any benefit obtained from the parts that have been compiled XPLINK. In fact, performance could degrade from the pure non-XPLINK case. If the number of pure XPLINK function calls is significantly greater than the number of "cross-linkage" calls, the cost saved on XPLINK calls will offset the costs associated with calls that involve stack swapping.

When you introduce an XPLINK program object into your application (for example, an XPLINK version of a vendor-DLL which your application uses), your application must run in an XPLINK environment (this is controlled by the XPLINK runtime option). In an XPLINK environment, an XPLINK version of the C/C++ Runtime Library (RTL) is used. You cannot have both the non-XPLINK and XPLINK versions of the C/C++ RTL active at the same time, so non-XPLINK callers of the C/C++ RTL will also incur this stack swapping overhead in an XPLINK environment.

The maximum performance improvement can be achieved by recompiling an entire application XPLINK. The further the application gets from pure XPLINK, the less the performance improvement. At some point, you may actually see a performance degradation.

The only compiler that currently supports the XPLINK compiler option is the z/OS C/C++ compiler. All COBOL and PL/I programs are non-XPLINK. Calls between COBOL or PL/I and XPLINK-compiled C/C++ are cross-linkage calls and will incur the stack swapping overhead.

For more information on making ILC calls with XPLINK, refer to *z/OS V2R1.0 Language Environment Writing Interlanguage Communication Applications*.

Applications that use Language Environment facilities that are not supported in an XPLINK environment, or that use products that are not supported in an XPLINK environment (for example, CICS), can not be recompiled as XPLINK applications.

For more information about XPLINK, see *z/OS Language Environment Programming Guide*.

---

## Using the IPA option

Interprocedural Analysis (IPA), through the IPA compiler option, can also improve the execution time of your z/OS XL C/C++ application. IPA is a mechanism for performing optimizations across compilation unit boundaries. It also performs optimizations not otherwise available with the z/OS XL C/C++ compiler, such as:

- Inlining across compilation units



- Program partitioning
- Coalescing of global variables
- Code straightening
- Unreachable code elimination
- Call graph pruning of unreachable functions

IPA also supports Program-directed feedback (PDF). The PDF suboptions allow the compiler to use information from training runs when optimizing the code. The compiler can then focus its optimizations on the most executed parts of the code and move low-priority code out of the critical path.

This information provides an overview of the Interprocedural Analysis (IPA) processing that is available through the IPA compiler option. For more information, see:

- For the effects of IPA on compiling, compiler options, and compiler listings: IPA considerations in *z/OS XL C/C++ User's Guide*
- For the effects of IPA on pragmas: IPA considerations in *z/OS XL C/C++ Language Reference*

## Types of procedural analysis

The z/OS XL C/C++ compiler performs both intraprocedural and interprocedural analysis.

Intraprocedural analysis is a mechanism for performing optimization for each function in a compilation unit, using only the information available for that function and compilation unit.

Interprocedural analysis is a mechanism for performing optimization across function and compilation unit boundaries. When inlining is in effect, the C/C++ compiler performs a limited form of interprocedural analysis, where it only applies within a compilation unit.

Interprocedural analysis through the IPA compiler option improves upon the limited interprocedural analysis described above. When you invoke interprocedural analysis through the IPA option, the compiler performs optimizations across the entire program. It also performs optimizations not otherwise available with the C/C++ compiler. The types of optimizations performed include:

### Inlining across compilation units

Inlining replaces certain function calls with the actual code of the function. Inlining not only eliminates the linkage overhead but also exposes the entire function to the caller and thus enables the compiler to better optimize your code.

### Program partitioning

Program partitioning improves performance by reordering functions to exploit locality of reference. Functions that call each other frequently will be closer together in memory.

### Coalescing of global variables

The compiler puts global variables into one or more structures and accesses the variables by calculating the offsets from the beginning of the structures. This lowers the cost of variable access and exploits data locality.

### Code straightening

Code straightening streamlines the flow of your program.



**Unreachable code elimination**

Unreachable code elimination removes unreachable code within a function.

**Call graph pruning of unreachable functions**

Call graph pruning of unreachable functions removes code that is 100% inlined or never referenced.

**Intraprocedural constant and set propagation**

IPA propagates floating point and integer constants to their uses and computes constant expressions at compile time. Also, variable uses that are known to be one of several constants can result in the folding of conditionals and switches.

**Intraprocedural pointer alias analysis**

IPA tracks pointer definitions to their uses, resulting in more refined information about memory locations that a pointer dereference may use or define. This enables other parts of the compiler to better optimize code around such dereferences. IPA tracks data and function pointer definitions. When a pointer dereference can only refer to a single memory location or function, the dereference is rewritten to be an explicit reference to the memory location or function.

**Intraprocedural copy propagation**

IPA propagates expressions defining some variables to the uses of the variable. This creates additional opportunities for constant expression folding. It also eliminates redundant variable copies.

**Intraprocedural unreachable code and store elimination**

IPA removes definitions of variables that cannot be reached, along with the computation feeding the definition.

**Conversion of reference (address) arguments to value arguments**

IPA converts reference (address) arguments to value arguments when the formal parameter is not written in the called procedure.

**Conversion of static variables to automatic (stack) variables**

IPA converts static variables to automatic (stack) variables when their use is limited to a single procedure invocation.

The execution time for code optimized using interprocedural analysis (IPA compile and link) is normally faster than for code optimized using intraprocedural analysis (IPA compile only) or the OPT compiler option. Please note that not all applications are suited for IPA optimization and the performance gains realized from using IPA will vary.

**Note:** For additional information about using the IPA(LINK) option, see “IPA(LINK) option and exploitation of 64-bit virtual memory” on page 332.

## Program-directed feedback

IPA uses program-directed feedback (PDF) to organize the code and to focus optimization on the frequently-used portions of the code. This can result in significant performance gains. Using PDF is a two-step process, that first gathers training data, then optimizes code during compile time.

Training data is gathered by running an application that was built using the PDF suboptions. When the application is run it collects information about itself. This information is the training data. The application should be run in a normal manner with accurate and varied input in order to gather as much valid training data as possible.

The second IPA build uses the training data when optimizing. This training data gives IPA information on:

- The most common paths
- The critical paths
- The least-used parts of the code

As of z/OS V1R12 XL C/C++ compiler, stale profiling data can be used in the second stage of the PDF process, if minor changes are made to the source file in the first PDF stage. As a result of this change to the behavior of the PDF process, it will be possible to run both stages of PDF under different compilation options. The compiler will issue a list of warnings but will not terminate. During the link step, the compiler will print a message identifying any functions that have been detected to change from the first stage of PDF process.

## Compiler processing flow

IPA changes the flow of compiler processing. The following sections explain the differences.

### Regular compiler execution

If you specify the NOIPA compiler option (the default), the compiler processes source files, as shown in Figure 170. The output is an object module for each source file processed. You can then bind the object modules to produce an executable module.

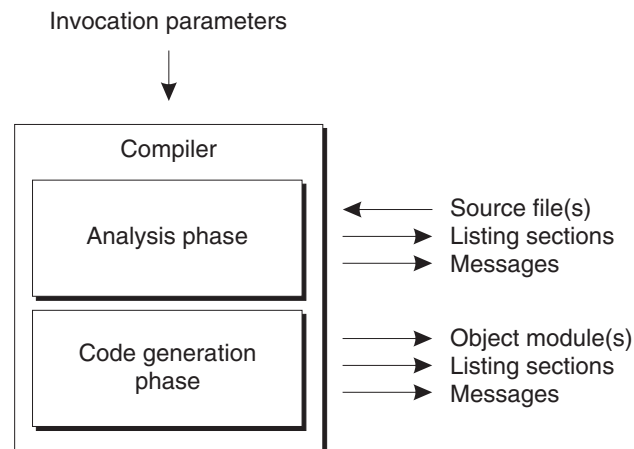

Figure 170. Flow of regular compiler processing

### Compiler execution with IPA

IPA processing consists of two steps: IPA Compile and IPA Link. You run the IPA Compile step once for each compilation unit, and run the IPA Link step once for the program as a whole. The final output is a single IPA-optimized object module which you must bind with the binder to produce an executable load module.

#### Notes:

- If you want to get the maximum benefit from IPA, run both the IPA Compile and IPA Link steps.
- In z/OS UNIX shell environments, the c89 utility is required during the IPA Link step.

You can invoke the IPA Compile step in the same environments that you use for a regular compilation. You can invoke the IPA Link step only in MVS batch mode or in one of the z/OS UNIX shell environments through the c89 utility.

This information describes the flow of IPA processing under MVS batch. The flow of processing with the c89 utility is the same, but there are differences in how you invoke IPA.

**IPA Compile step processing:** You invoke the IPA Compile step by specifying the IPA(NOLINK) compiler option, as shown in Figure 171. (NOLINK is the default suboption). During the IPA Compile step, the compiler creates optimized objects. These objects contain information that the IPA Link step can use for further optimization.

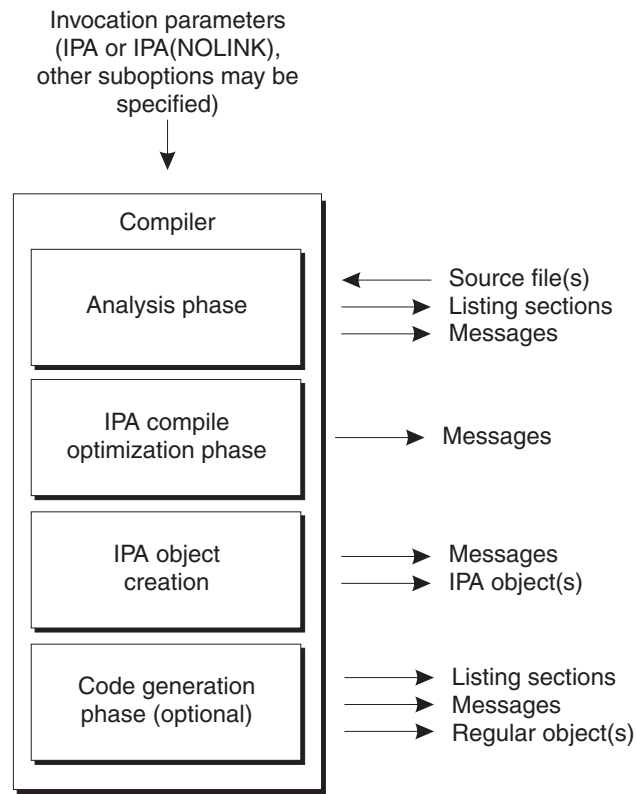

Figure 171. IPA compile step processing

The following processing takes place for each compilation unit that you specify for the IPA Compile step:

1. The compiler determines the final suboptions for the IPA option, based upon the compiler options and IPA suboptions that you specified. This is necessary because the compiler does not support some combinations of compiler options and IPA suboptions. The compiler issues a warning message if it finds unsupported combinations.
2. The compiler promotes some IPA suboptions based upon the presence of related compiler options and issues informational messages if it does so. For more information, see interactions in *z/OS XL C/C++ User's Guide*.
3. The compiler generates an IPA object file. This object file contains control information for a compilation unit required for the IPA Link step.

The IPA object module produced by IPA (NOLINK,NOOBJECT) has the same structure as a regular object module. It should not be used as input to the prelinker, linker, or binder.

Each IPA object contains a CSECT that includes the ESD name @@IPA0BJ.

4. If you specify the OBJECT suboption of the IPA option, the compiler produces a combined IPA and conventional object file. While the conventional object file is not required by the IPA Link step, creating it permits you to bind this file to create an executable module, without doing the IPA Link step, because it is more difficult to debug coded optimized by the interprocedural analysis.

During the IPA Compile step, the compiler generates information that allows you to create object libraries with the **C370LIB** utility or to create z/OS UNIX archives with the **ar** utility. The information consists of XSD and ESD records for the external symbols that were defined in the compilation units of your program. You can use the object libraries and z/OS UNIX archives for autocall searching in the IPA Link step. During autocall searching, the IPA Link step searches these libraries and archives for external references from your program.

**IPA Link step processing:** You invoke the IPA Link step by specifying the IPA(LINK) compiler option, as shown in Figure 172. During this step, the compiler links the IPA objects that were produced by the IPA Compile step (along with non-IPA object files and load modules, if specified), does partitioning, performs optimizations, and generates the final object code.

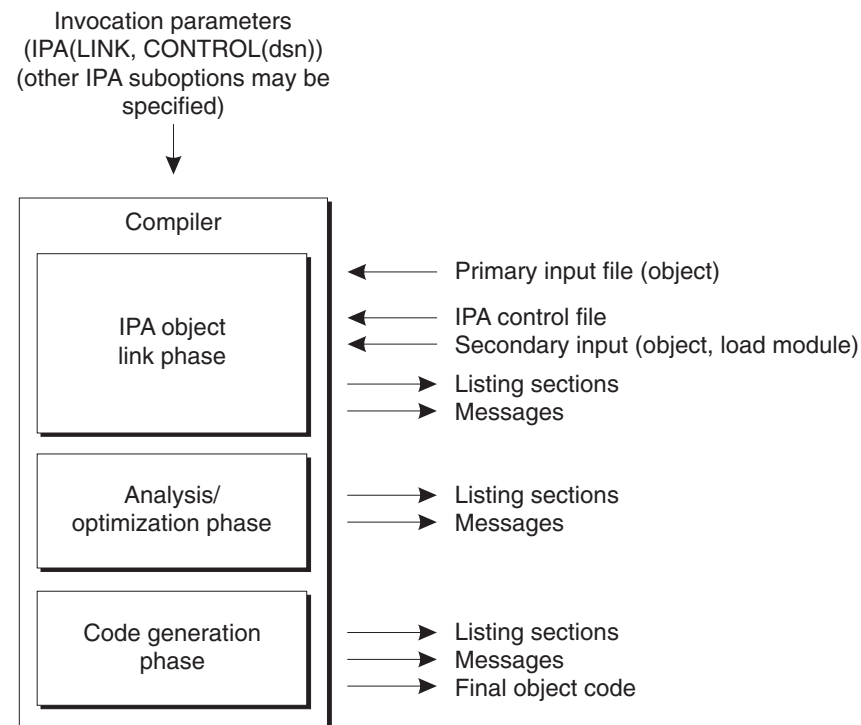

Figure 172. IPA link step processing

The following processing takes place:

1. The compiler determines the final suboptions for the IPA option, based upon the compiler options and IPA suboptions you specify. This is necessary because

some combinations of compiler options and IPA suboptions are unsupported. The compiler issues informational and warning messages for unsupported combinations.

2. The compiler links IPA object files, as well as non-IPA object files and load modules (if specified). The compiler also merges information from the IPA Compile step.

Input for the Link step comes from one of three sources:

- The primary input file (specified by the SYSIN ddname). This can be either:
  - A set of IPA Link control statements that you create  
These may be INCLUDE and LIBRARY IPA Link control statements that explicitly identify secondary input files. IPA uses the same control statement format (with some exceptions) used by the binder.
  - The IPA object file from the compilation unit that contains the main function or fetchable entry point. If you specify this file, the compiler searches for all other IPA files using the SYSLIB ddname.

- One or more secondary input files

The secondary input file may contain:

- IPA object files or PDS libraries
- Conventional object files or PDS libraries
- Load module libraries
- z/OS UNIX archive libraries
- IPA Link control statements

These secondary input files are to be used for autocall searches. You can specify these files through the SYSLIB ddname or explicitly include them through INCLUDE or LIBRARY IPA Link control statements on the IPA Link step.

Load module libraries are used to support library interface routines (such as CICS and Language Environment) that are implemented as load module libraries. Since IPA must resolve all parts of your application program before beginning optimization, make all of these libraries as well as your application object modules available to the IPA Link step.

The IPA Link step resolves external references using explicit and autocall resolution. This allows IPA to identify the static and global data and the external references for the whole program.

Ensure that you do not accidentally specify FB, LRECL 80 source files as input to the IPA Link step. The IPA Link step will assume that records from these files contain valid object information, and will retain them in the object file. When the linkage editor processes the object file, it will determine the records to be invalid, and will issue diagnostic messages.

- The IPA Link step control file. This file contains additional IPA control directives. The CONTROL suboption of the IPA compiler option identifies this file. For more information, see IPA Link step control file in *z/OS XL C/C++ User's Guide*.
3. As objects are processed, IPA Link Step builds the program call graph, merging the IPA object code according to its place in the call graph. If necessary, IPA Link Step stores non-IPA object code for inclusion in the final object file, and converts load module library members into object format for inclusion in the final object file.
  4. The compiler performs optimizations across the call graph. You specify the type and extent of optimizations using the LEVEL suboption of the IPA compiler option.

5. IPA Link Step divides the program call graph into separate units called partitions. Partitioning of the call graph is controlled by:
  - The partition size limit that is specified in the IPA control file.
  - The connectivity of your program. IPA places code that is isolated from the rest of the program into a separate partition.
  - Resolution of conflicting effects between the compiler options and pragmas specified for compilation units processed during the IPA Compile step. These are the compiler options and pragmas that generate information during the analysis phase of the compiler for input to the code-generation phase.IPA Link Step produces a final single object module for the program from these partitions.

You must bind the IPA single object module to produce the executable module.

**Note:** IPA Compile and IPA Link, as follows:

- An object file produced by an IPA Compile that contains IPA Object or combined IPA and conventional object information can be used as input to the z/OS XL C/C++ IPA Link of the same or later Version/Release.
- An object file produced by an IPA Compile that contains IPA Object or combined IPA and conventional object information cannot be used as input by the z/OS XL C/C++ IPA Link of an earlier Version/Release. If this is attempted, the IPA Link will issue an error diagnostic message.
- If the IPA object is recompiled by a later z/OS XL C/C++ IPA Compile, additional optimizations may be performed and the resulting application program may perform better.

An exception to this is the IPA object files produced by the OS/390 Release 2 C IPA Compile. These must be recompiled from the program source using a compiler that is version OS/390 Release 3 or later before attempting to process them with the current IPA Link.



---

## Chapter 43. Using high performance libraries

IBM z/OS XL C/C++ is shipped with a set of libraries for high-performance mathematical computing:

- The Mathematical Acceleration Subsystem (MASS) is a set of libraries of tuned mathematical intrinsic functions that provide improved performance over the corresponding standard system math library functions. MASS is described in “Using the Mathematical Acceleration Subsystem (MASS) libraries.”
- The Automatically Tuned Linear Algebra Software (ATLAS) is a set of high-performance, processor-tuned linear algebra libraries. ATLAS is described in “Using the Automatically Tuned Linear Algebra Software (ATLAS) libraries” on page 753.

---

### Using the Mathematical Acceleration Subsystem (MASS) libraries

The XL C/C++ compiler is shipped with a set of Mathematical Acceleration Subsystem (MASS) libraries for high-performance mathematical computing.

The MASS libraries consist of a library of scalar C functions tuned for specific architectures described in “Using the MASS scalar library,” a vector library tuned for specific architectures described in “Using the MASS vector library” on page 744, and a SIMD library tuned for specific architectures described in “Using the MASS SIMD library” on page 748. Note that accuracy and exception handling might not be identical between MASS functions and system library functions.

The MASS functions must run with the round-to-nearest rounding mode (ROUND(N)), ARCHITECTURE(10) or higher, FLOAT(IEEE), and exception trapping turned off (NOEXH, C++ only). If you want to use the MASS SIMD functions, ARCHITECTURE(11) and VECTOR options are required.

“Compiling and linking a program with MASS” on page 749 describes how to compile and link a program that uses the MASS libraries, and how to selectively use the MASS scalar library functions in conjunction with the regular system libraries.

### Using the MASS scalar library

The MASS scalar library contains an accelerated set of frequently used math intrinsic functions. They are compatible with 31-bit C linkage, 31-bit XPLINK, and 64-bit. If you want to explicitly call the MASS scalar functions, you can take the following steps:

1. Provide the prototypes for the functions by including `math.h` and `mass.h` in your source files. See the table below for the location of header files.
2. Link the appropriate scalar library with your application. Names of libraries are described in the following table.

Table 326. Header files and library names for the MASS scalar library

System Environment	Header file location	Library name for zEC12/zBC12	Library name for z13
USS	<ul style="list-style-type: none"><li>• <code>/usr/include/math.h</code></li><li>• <code>/usr/include/mass.h</code></li></ul>	<code>/usr/lpp/cbclib/lib/libmass.arch10.a</code>	<code>/usr/lpp/cbclib/lib/libmass.arch11.a</code>



Table 326. Header files and library names for the MASS scalar library (continued)

System Environment	Header file location	Library name for zEC12/zBC12	Library name for z13
MVS	CEE.SCEEH.H	<ul style="list-style-type: none"> <li>• CBC.SCCNM10 (for functions that overlap with &lt;math.h&gt;)</li> <li>• CBC.SCCNN10 (for functions which are only introduced in &lt;mass.h&gt;)</li> </ul>	<ul style="list-style-type: none"> <li>• CBC.SCCNM11 (for functions that overlap with &lt;math.h&gt;)</li> <li>• CBC.SCCNN11 (for functions which are only introduced in &lt;mass.h&gt;)</li> </ul>

**Note:** MASS scalar functions can only run on IBM zEC12/zBC12/z13 and newer machine models. A set of libraries tuned for each machine model group are provided.

The MASS scalar functions accept double-precision parameters and return a double-precision result, or accept single-precision parameters and return a single-precision result, except sincos which gives 2 double-precision results. They are summarized in Table 327

Table 327. MASS scalar functions

Double-precision function	Single-precision function	Description	Double-precision function prototype	Single-precision function prototype
acos	acosf	Returns the arc cosine of x	double acos (double x);	float acosf (float x);
acosh	acoshf	Returns the arc hyperbolic cosine of x	double acosh (double x);	float acoshf (float x);
	anint <sup>t</sup>	Returns the nearest integer to x (as a float)		float anint (float x);
asin	asinf	Returns the arc sine of x	double asin (double x);	float asinf (float x);
asinh	asinhf	Returns the arc hyperbolic sine of x	double asinh (double x);	float asinhf (float x);
atan2	atan2f	Returns the arc tangent of x/y	double atan2 (double x, double y);	float atan2f (float x, float y);
atan	atanf	Returns the arc tangent of x	double atan (double x);	float atanf (float x);
atanh	atanhf	Returns the arc hyperbolic tangent of x	double atanh (double x);	float atanhf (float x);
cbrt	cbrtf	Returns the cube root of x	double cbrt (double x);	float cbrtf (float x);
copysign	copysignf	Returns x with the sign of y	double copysign (double x, double y);	float copysignf (float x);
cos	cosf	Returns the cosine of x	double cos (double x);	float cosf (float x);
cosh	coshf	Returns the hyperbolic cosine of x	double cosh (double x);	float coshf (float x);

Table 327. MASS scalar functions (continued)

Double-precision function	Single-precision function	Description	Double-precision function prototype	Single-precision function prototype
cosisin		Returns a complex number with the real part cosine of $x$ and the imaginary part sine of $x$ .	double_Complex cosisin (double);	
dnint <sup>t</sup>		Returns the nearest integer to $x$ (as a double)	double dnint (double $x$ );	
erf	erff	Returns the error function of $x$	double erf (double $x$ );	float erff (float $x$ );
erfc	erfcf	Returns the complementary error function of $x$	double erfc (double $x$ );	float erfcf (float $x$ );
exp	expf	Returns the exponential function of $x$	double exp (double $x$ );	float expf (float $x$ );
expm1	expm1f	Returns (the exponential function of $x$ ) - 1	double expm1 (double $x$ );	float expm1f (float $x$ );
hypot	hypotf	Returns the square root of $x^2 + y^2$	double hypot (double $x$ , double $y$ );	float hypotf (float $x$ , float $y$ );
lgamma	lgammaf	Returns the natural logarithm of the absolute value of the Gamma function of $x$	double lgamma (double $x$ );	float lgammaf (float $x$ );
log	logf	Returns the natural logarithm of $x$	double log (double $x$ );	float logf (float $x$ );
log10	log10f	Returns the base 10 logarithm of $x$	double log10 (double $x$ );	float log10f (float $x$ );
log1p	log1pf	Returns the natural logarithm of ( $x + 1$ )	double log1p (double $x$ );	float log1pf (float $x$ );
pow	powf	Returns $x$ raised to the power $y$	double pow (double $x$ , double $y$ );	float powf (float $x$ , float $y$ );
rint	rintf	Returns the nearest integer to $x$ (as a double)	double rint (double $x$ );	float rintf (float $x$ );
rsqrt <sup>t</sup>		Returns the reciprocal of the square root of $x$	double rsqrt (double $x$ );	
sin	sinf	Returns the sine of $x$	double sin (double $x$ );	float sinf (float $x$ );
sincos <sup>t</sup>		Sets $*s$ to the sine of $x$ and $*c$ to the cosine of $x$	void sincos (double $x$ , double* $s$ , double* $c$ );	
sinh	sinhf	Returns the hyperbolic sine of $x$	double sinh (double $x$ );	float sinhf (float $x$ );
sqrt		Returns the square root of $x$	double sqrt (double $x$ );	
tan	tanf	Returns the tangent of $x$	double tan (double $x$ );	float tanf (float $x$ );

Table 327. MASS scalar functions (continued)

Double-precision function	Single-precision function	Description	Double-precision function prototype	Single-precision function prototype
tanh	tanhf	Returns the hyperbolic tangent of x	double tanh (double x);	float tanhf (float x);

**Notes:**

- Functions denoted as function-name<sup>t</sup> are declared in <mass.h>, and all other functions are declared in <math.h>.
- The trigonometric functions (sin, cos, tan) return NaN (Not-a-Number) for large arguments (where the absolute value is greater than 2<sup>50</sup>pi).
- The pow function accepts negative x arguments with integer y arguments according to the C standard.
- In some cases, the MASS functions are not as precise as the system library, and they might handle edge cases differently (sqrt(Inf), for example).

## Using the MASS vector library

The MASS vector library provides a set of functions that compute the same mathematical function for vectors of operands. If you want to explicitly call the MASS vector functions, take the following steps:

1. Provide the prototypes for the functions by including massv.h in your source files. See the table below for the location of header files.
2. Link the appropriate library with your application. Names of libraries are described in the following table.

Table 328. Header files and library names for the MASS vector library

System Environment	Header file location	Library name for zEC12/zBC12	Library name for z13
USS	/usr/include/massv.h	/usr/lpp/cbc/lib/lib/libmassv.arch10.a	/usr/lpp/cbc/lib/lib/libmassv.arch11.a
MVS	CEE.SCEEH.H	CBC.SCCNN10	CBC.SCCNN11

**Note:** MASS vector functions can only run on IBM zEC12/zBC12/z13 and newer hardware models. A set of libraries tuned for each machine model group are provided.

The single-precision and double-precision floating-point functions contained in the vector library are summarized in Table 329 on page 745. Note that in C and C++ applications, only call by reference is supported, even for scalar arguments. With the exception of a few functions (described in the following paragraph), all of the floating-point functions in the vector library accept three parameters:

- A double-precision (for double-precision functions) or single-precision (for single-precision functions) vector output parameter
- A double-precision (for double-precision functions) or single-precision (for single-precision functions) vector input parameter
- An integer vector-length parameter

Except for the special cases listed below, the functions are of the form:

*function\_name* (y,x,n)

where  $y$  is the target vector,  $x$  is the source vector, and  $n$  is the pointer to the vector length. The parameters  $y$  and  $x$  are assumed to be double-precision for functions with the prefix  $v$ , and single-precision for functions with the prefix  $vs$ . For example, the following code:

```
#include <massv.h>

double x[500], y[500];
int n;
n = 500;
...
vexp (y, x, &n);
```

outputs a vector  $y$  of length 500 whose elements are  $\exp(x[i])$ , where  $i=0, \dots, 499$ .

The functions  $vdiv$ ,  $vsincos$ ,  $vpow$ , and  $vatan2$  (and their single-precision versions,  $vsdiv$ ,  $vssincos$ ,  $vspow$ , and  $vsatan2$ ) take four arguments. The functions  $vdiv$ ,  $vpow$ , and  $vatan2$  take the arguments  $(z, x, y, n)$ . The function  $vdiv$  outputs a vector  $z$  whose elements are  $x[i]/y[i]$ , where  $i=0, \dots, *n-1$ . The function  $vpow$  outputs a vector  $z$  whose elements are  $x[i]^{y[i]}$ , where  $i=0, \dots, *n-1$ . The function  $vatan2$  outputs a vector  $z$  whose elements are  $\text{atan}(x[i]/y[i])$ , where  $i=0, \dots, *n-1$ . The function  $vsincos$  takes the arguments  $(y, z, x, n)$ , and outputs two vectors,  $y$  and  $z$ , whose elements are  $\sin(x[i])$  and  $\cos(x[i])$ , respectively.

Note that some of the MASS floating point vector functions are only available when compiled with ARCHITECTURE(11). These functions are denoted by having a superscript 't' after their name (for example, "function<sup>t</sup>" in the following table.)

Table 329. MASS floating-point vector functions

Double-precision function	Single-precision function	Description	Double-precision function prototype	Single-precision function prototype
<code>vacos</code>	<code>vsacos</code>	Sets $y[i]$ to the arc cosine of $x[i]$ , for $i=0, \dots, *n-1$	<code>void vacos (double y[], double x[], int *n);</code>	<code>void vsacos (float y[], float x[], int *n);</code>
<code>vacosh</code>	<code>vsacosh</code>	Sets $y[i]$ to the hyperbolic arc cosine of $x[i]$ , for $i=0, \dots, *n-1$	<code>void vacosh (double y[], double x[], int *n);</code>	<code>void vsacosh (float y[], float x[], int *n);</code>
<code>vasin</code>	<code>vsasin</code>	Sets $y[i]$ to the arc sine of $x[i]$ , for $i=0, \dots, *n-1$	<code>void vasin (double y[], double x[], int *n);</code>	<code>void vsasin (float y[], float x[], int *n);</code>
<code>vasinh</code>	<code>vsasinh</code>	Sets $y[i]$ to the hyperbolic arc sine of $x[i]$ , for $i=0, \dots, *n-1$	<code>void vasinh (double y[], double x[], int *n);</code>	<code>void vsasinh (float y[], float x[], int *n);</code>
<code>vatan2</code>	<code>vsatan2</code>	Sets $z[i]$ to the arc tangent of $x[i]/y[i]$ , for $i=0, \dots, *n-1$	<code>void vatan2 (double z[], double x[], double y[], int *n);</code>	<code>void vsatan2 (float z[], float x[], float y[], int *n);</code>
<code>vatan<sup>t</sup></code>	<code>vsatan<sup>t</sup></code>	Sets $y[i]$ to the arc tangent of $x[i]$ , for $i=0, \dots, *n-1$	<code>void vatan (double y[], double x[], int *n);</code>	<code>void vsatan (float y[], float x[], int *n);</code>
<code>vatanh</code>	<code>vsatanh</code>	Sets $y[i]$ to the hyperbolic arc tangent of $x[i]$ , for $i=0, \dots, *n-1$	<code>void vatanh (double y[], double x[], int *n);</code>	<code>void vsatanh (float y[], float x[], int *n);</code>
<code>vcbrt</code>	<code>vsqrt</code>	Sets $y[i]$ to the cube root of $x[i]$ , for $i=0, \dots, *n-1$	<code>void vcbrt (double y[], double x[], int *n);</code>	<code>void vsqrt (float y[], float x[], int *n);</code>
<code>vcos</code>	<code>vscos</code>	Sets $y[i]$ to the cosine of $x[i]$ , for $i=0, \dots, *n-1$	<code>void vcos (double y[], double x[], int *n);</code>	<code>void vscos (float y[], float x[], int *n);</code>

Table 329. MASS floating-point vector functions (continued)

Double-precision function	Single-precision function	Description	Double-precision function prototype	Single-precision function prototype
vcosh	vscosh	Sets $y[i]$ to the hyperbolic cosine of $x[i]$ , for $i=0,..,*n-1$	void vcosh (double y[], double x[], int *n);	void vscosh (float y[], float x[], int *n);
vcosisin	vscosisin	Sets the real part of $y[i]$ to the cosine of $x[i]$ and the imaginary part of $y[i]$ to the sine of $x[i]$ , for $i=0,..,*n-1$	void vcosisin (double _Complex y[], double x[], int *n);	void vscosisin (float _Complex y[], float x[], int *n);
vdint		Sets $y[i]$ to the integer truncation of $x[i]$ , for $i=0,..,*n-1$	void vdint (double y[], double x[], int *n);	
vdiv	vsdiv	Sets $z[i]$ to $x[i]/y[i]$ , for $i=0,..,*n-1$	void vdiv (double z[], double x[], double y[], int *n);	void vsdiv (float z[], float x[], float y[], int *n);
vdnint		Sets $y[i]$ to the nearest integer to $x[i]$ , for $i=0,..,*n-1$	void vdnint (double y[], double x[], int *n);	
verf <sup>t</sup>	vserf <sup>t</sup>	Sets $y[i]$ to the error function of $x[i]$ , for $i=0,..,*n-1$	void verf (double y[], double x[], int *n)	void vserf (float y[], float x[], int *n)
verfc <sup>t</sup>	vserfc <sup>t</sup>	Sets $y[i]$ to the complimentary error function of $x[i]$ , for $i=0,..,*n-1$	void verfc (double y[], double x[], int *n)	void vserfc (float y[], float x[], int *n)
vexp	vsexp	Sets $y[i]$ to the exponential function of $x[i]$ , for $i=0,..,*n-1$	void vexp (double y[], double x[], int *n);	void vsexp (float y[], float x[], int *n);
vexp2 <sup>t</sup>	vsexp2 <sup>t</sup>	Sets $y[i]$ to 2 raised to the power of $x[i]$ , for $i=1,..,*n-1$	void vexp2 (double y[], double x[], int *n);	void vsexp2 (float y[], float x[], int *n);
vexpm1	vsexpm1	Sets $y[i]$ to (the exponential function of $x[i]$ )-1, for $i=0,..,*n-1$	void vexpm1 (double y[], double x[], int *n);	void vsexpm1 (float y[], float x[], int *n);
vexp2m1 <sup>t</sup>	vsexp2m1 <sup>t</sup>	Sets $y[i]$ to (2 raised to the power of $x[i]$ ) - 1, for $i=1,..,*n-1$	void vexp2m1 (double y[], double x[], int *n);	void vsexp2m1 (float y[], float x[], int *n);
vhypot <sup>t</sup>	vshypot <sup>t</sup>	Sets $z[i]$ to the square root of the sum of the squares of $x[i]$ and $y[i]$ , for $i=0,..,*n-1$	void vhypot (double z[], double x[], double y[], int *n)	void vshypot (float z[], float x[], float y[], int *n)
vlog	vslog	Sets $y[i]$ to the natural logarithm of $x[i]$ , for $i=0,..,*n-1$	void vlog (double y[], double x[], int *n);	void vslog (float y[], float x[], int *n);
vlog2 <sup>t</sup>	vslog2 <sup>t</sup>	Sets $y[i]$ to the base-2 logarithm of $x[i]$ , for $i=1,..,*n-1$	void vlog2 (double y[], double x[], int *n);	void vslog2 (float y[], float x[], int *n);
vlog10	vslog10	Sets $y[i]$ to the base-10 logarithm of $x[i]$ , for $i=0,..,*n-1$	void vlog10 (double y[], double x[], int *n);	void vslog10 (float y[], float x[], int *n);

Table 329. MASS floating-point vector functions (continued)

Double-precision function	Single-precision function	Description	Double-precision function prototype	Single-precision function prototype
vlog1p	vslog1p	Sets $y[i]$ to the natural logarithm of $(x[i]+1)$ , for $i=0,..,*n-1$	void vlog1p (double y[], double x[], int *n);	void vslog1p (float y[], float x[], int *n);
vlog21p <sup>t</sup>	vslog21p <sup>t</sup>	Sets $y[i]$ to the base-2 logarithm of $(x[i]+1)$ , for $i=1,..,*n-1$	void vlog21p (double y[], double x[], int *n);	void vslog21p (float y[], float x[], int *n);
vpow	vspow	Sets $z[i]$ to $x[i]$ raised to the power $y[i]$ , for $i=0,..,*n-1$	void vpow (double z[], double x[], double y[], int *n);	void vspow (float z[], float x[], float y[], int *n);
vqdrft	vsqdrft	Sets $y[i]$ to the fourth root of $x[i]$ , for $i=0,..,*n-1$	void vqdrft (double y[], double x[], int *n);	void vsqdrft (float y[], float x[], int *n);
vrcbrt	vsrbrt	Sets $y[i]$ to the reciprocal of the cube root of $x[i]$ , for $i=0,..,*n-1$	void vrcbrt (double y[], double x[], int *n);	void vsrbrt (float y[], float x[], int *n);
vrec	vsrec	Sets $y[i]$ to the reciprocal of $x[i]$ , for $i=0,..,*n-1$	void vrec (double y[], double x[], int *n);	void vsrec (float y[], float x[], int *n);
vrqdrft	vsrqdrft	Sets $y[i]$ to the reciprocal of the fourth root of $x[i]$ , for $i=0,..,*n-1$	void vrqdrft (double y[], double x[], int *n);	void vsrqdrft (float y[], float x[], int *n);
vrsqrt	vsrsqrt	Sets $y[i]$ to the reciprocal of the square root of $x[i]$ , for $i=0,..,*n-1$	void vrsqrt (double y[], double x[], int *n);	void vsrsqrt (float y[], float x[], int *n);
vsin	vssin	Sets $y[i]$ to the sine of $x[i]$ , for $i=0,..,*n-1$	void vsin (double y[], double x[], int *n);	void vssin (float y[], float x[], int *n);
vsincos	vssincos	Sets $y[i]$ to the sine of $x[i]$ and $z[i]$ to the cosine of $x[i]$ , for $i=0,..,*n-1$	void vsincos (double y[], double z[], double x[], int *n);	void vssincos (float y[], float z[], float x[], int *n);
vsinh	vssinh	Sets $y[i]$ to the hyperbolic sine of $x[i]$ , for $i=0,..,*n-1$	void vsinh (double y[], double x[], int *n);	void vssinh (float y[], float x[], int *n);
vsqrt	vssqrt	Sets $y[i]$ to the square root of $x[i]$ , for $i=0,..,*n-1$	void vsqrt (double y[], double x[], int *n);	void vssqrt (float y[], float x[], int *n);
vtan	vstan	Sets $y[i]$ to the tangent of $x[i]$ , for $i=0,..,*n-1$	void vtan (double y[], double x[], int *n);	void vstan (float y[], float x[], int *n);
vtanh	vstanh	Sets $y[i]$ to the hyperbolic tangent of $x[i]$ , for $i=0,..,*n-1$	void vtanh (double y[], double x[], int *n);	void vstanh (float y[], float x[], int *n);

Integer functions are of the form *function\_name* ( $x[], *n$ ), where  $x[]$  is a vector of 4-byte (for vpopcnt4) or 8-byte (for vpopcnt8) numeric objects (integral or floating-point), and  $*n$  is the vector length.

Table 330. MASS integer vector functions

Function	Description	Prototype
vpopcnt4	Returns the total number of 1 bits in the concatenation of the binary representation of $x[i]$ , for $i=0,..,*n-1$ , where $x$ is a vector of 32-bit objects.	unsigned int vpopcnt4 (void *x, int *n)

Table 330. MASS integer vector functions (continued)

Function	Description	Prototype
vpopcnt8	Returns the total number of 1 bits in the concatenation of the binary representation of $x[i]$ , for $i=0,\dots,*n-1$ , where $x$ is a vector of 64-bit objects.	unsigned int vpopcnt8 (void *x, int *n)

## Using the MASS SIMD library

The MASS SIMD library contains a set of frequently used math intrinsic functions that provide improved performance over the corresponding standard scalar system library functions, and operate on and return vector data types. If you want to explicitly call the MASS SIMD functions, take the following steps:

1. Link the appropriate scalar library with your application using information in the following table.
2. Provide the prototypes for the functions by including `mass_simd.h` in your source files. The default installation location of these files is as follows:
  - In USS, `mass_simd.h` can be found in `/usr/include`.
  - Under MVS (batch mode), the headers are found in `CEE.SCEEH.H`.
3. Link the appropriate SIMD library with your application using information in the following table.

Table 331. Header files and library names for the MASS SIMD library

System Environment	Header file location	Library name for z13
USS	<code>/usr/include/mass_simd.h</code>	<code>/usr/lpp/cbc/lib/lib/libmass_simd.arch11.a</code>
MVS	<code>CEE.SCEEH.H</code>	<code>CBC.SCCNN11</code>

**Note:** MASS SIMD functions can only run on IBM z13 and newer hardware models.

The double-precision MASS SIMD functions have arguments and return values of type vector double. The available MASS SIMD functions are summarized in Table 332.

Table 332. MASS SIMD functions

Double-precision function	Description	Double-precision function prototype
cosd2	Computes the cosine of each element of $vx$ .	vector double cosd2 (vector double $vx$ );
divd2	Computes the quotient $vx/vy$ .	vector double divd2 (vector double $vx$ , vector double $vy$ );
expd2	Computes the exponential function of each element of $vx$ .	vector double expd2 (vector double $vx$ );
logd2	Computes the natural logarithm of each element of $vx$ .	vector double logd2 (vector double $vx$ );
powd2	Computes each element of $vx$ raised to the power of the corresponding element of $vy$ .	vector double powd2 (vector double $vx$ , vector double $vy$ );

Table 332. MASS SIMD functions (continued)

Double-precision function	Description	Double-precision function prototype
recipd2	Computes the reciprocal of each element of vx.	vector double recipd2 (vector double vx);
sind2	Computes the sine of each element of vx.	vector double sind2 (vector double vx);
sqrtd2	Computes the square root of each element of vx.	vector double sqrtd2 (vector double vx);

## Compiling and linking a program with MASS

This section deals with the specifics of compiling and linking your application with the MASS libraries.

This section describes the specifics of compiling and linking your application with the MASS libraries. The MASS libraries cannot be used with the prelinker.

### Required compiler options

To compile a program that utilizes any MASS functions, the following compiler options must be used:

- FLOAT(IEEE)
- ARCHITECTURE(10) - the minimum required ARCH level
- ARCHITECTURE(11) - required if you use any MASS SIMD functions
- VECTOR - required if you use any MASS SIMD functions
- NOEXH - required for C++ applications only
- LONGNAME

While you might still be able to compile your MASS application without satisfying the above requirements, the program will likely not give correct results.

### Compilation step - MASS headers

To use MASS functions in your application, you need to include the appropriate MASS header(s) for the type of MASS function being used (for a complete list of MASS functions available, see “Using the MASS scalar library” on page 741, “Using the MASS vector library” on page 744, and “Using the MASS SIMD library” on page 748).

The default installation of MASS places the MASS headers in your default header search path. If you cannot find the MASS headers in your default search path, contact your system programmer.

The following examples demonstrate the relationship among MASS functions, headers, and libraries, and show how to use MASS in your source program.

#### Sample 1:

```

/* Using the MASS-only scalar function 'rsqrt'
   Compile command: xlc -qARCH=10 -qFLOAT=IEEE -c sample1.c
*/
#include <math.h>
#include <mass.h> /* The 'rsqrt' function is declared in <mass.h>, not <math.h> */

```



```

int main(void) {
    double input = 16;
    double output;

    output = rsqrt(input);

    /* ... Code to utilize the results in "output" goes here */
}

```

### Sample 2:

```

/* Using the MASS scalar function 'pow'
   Compile command: xlc -qARCH=10 -qFLOAT=IEEE -c sample2.c
*/

#include <math.h> /* The 'pow' function is declared in <math.h>, not <mass.h> */
#include <mass.h>

int main(void) {

    double base = 3;
    double exponent = 2;
    double output;

    output = pow(base, exponent);

    /* ... Code to utilize the results in "output" goes here */
}

```

### Sample 3:

```

/* Call the MASS vector function 'vlog2'
   Compile command: xlc -qARCH=11 -qFLOAT=IEEE -c sample3.c
*/

#include <massv.h>

int main(void) {

    int size = 1000;
    double input[size];
    double output[size];

    input[0] = 8;
    input[1] = 16;
    ...
    input[999] = 42;

    vlog2(output, input, &size);

    /* ... Code to utilize the results in "output[]" goes here */
}

```

### Sample 4:

```

/* Call the MASS SIMD function 'powd2'
   Compile command: xlc -qARCH=11 -qFLOAT=IEEE -qVECTOR -c sample4.c
*/

#include <mass_simd.h>

int main(void) {

    vector double bases = {0, 1};
    vector double exponents = {2, 2};
    vector double output;
}

```

```

    output = powd2(bases, exponents);

    /* ... Code to utilize the results in "output" goes here */
}

```

### Sample 5:

```

/* Call the MASS scalar functions 'pow' and 'rsqrt', and
the vector function 'vlog10'
Compile command: xlc -qARCH=10 -qFLOAT=IEEE -c sample5.c
*/

#include <math.h>    /* This includes the prototype for 'pow' */
#include <mass.h>    /* This includes the prototype for 'rsqrt' */
#include <massv.h>   /* This includes the prototype for 'vlog10' */

int main(void) {

    int size = 1000;
    double input[size];
    double result[size];
    int i;

    for (i = 0; i < size; i++) {
        input[i] = i;    /* Trivially initialize the input vector */
    }

    vlog10(result, input, &size);
    double output = pow(result[27], result[525]);

    output = rsqrt(output);

    /* ... Code to utilize the results in "output" goes here */
}

```

## Link step - MASS libraries

IBM provides the MASS library in both USS and MVS. There is no performance difference based on where the library resides. This is simply to allow USS users to link with MASS in USS, and MVS users to link with MASS in MVS.

Although USS users can link with the copy of the MASS libraries which resides in PDS's (and vice-versa), IBM does not recommend this because it does not provide a performance gain, and it adds unnecessary complexity to your build process.

### Linking in USS

To link your program with the MASS library, include the appropriate library name(s) with the `-l` linker option, depending on which type of MASS functions are used, as well as which ARCHITECTURE suboption is used, ARCH(10) or ARCH(11).

- `-lmass.arch10` or `-lmass.arch11` For MASS scalar functions
- `-lmassv.arch10` or `-lmassv.arch11` For MASS vector functions
- `-lmass_simd.arch11` For MASS SIMD functions

### Sample 1

```

# Link the MASS-only scalar function 'rsqrt'.
# Assume 'sample1.o' was compiled with ARCHITECTURE(10).
xlc sample1.o -lmass.arch10

```

### Sample 2

```
# Link the MASS scalar function 'pow'.
# Assume 'sample2.o' was compiled with ARCHITECTURE(10).
xlc sample2.o -lmass.arch10
```

### Sample 3

```
# Link the MASS vector function 'vlog2'.
# Assume 'sample3.o' was compiled with ARCHITECTURE(11).
xlc sample3.o -lmassv.arch11
```

### Sample 4

```
# Link the MASS SIMD function 'powd2'.
# Assume 'sample4.o' was compiled with ARCHITECTURE(11).
xlc sample4.o -lmass_simd.arch11
```

### Sample 5

```
# Link the MASS scalar functions 'pow' and 'rsqrt', and
# the vector function 'vlog10'.
# Assume 'sample5.o' was compiled with ARCHITECTURE(10).
xlc sample5.o -lmass.arch10 -lmassv.arch10
```

## Linking in MVS

To link your program with the MASS library under MVS in batch mode, you must prepend the MASS library you want to use to your SYSLIB concatenation.

- CBC.SCCNM10 if you are using MASS scalar functions which are also available through `<math.h>`
- CBC.SCCNN10 for all other MASS functions

Note that this only applies to applications that are compiled with ARCHITECTURE(10) (for IBM zEC12/zBC12 and newer hardware).

The MVS library names for applications that are compiled with ARCHITECTURE(11) (for IBM z13 and newer hardware) are:

- CBC.SCCNM11 if you are using MASS scalar functions which are also available through `<math.h>`
- CBC.SCCNN11 for all other MASS functions

For example, if your current SYSLIB concatenation is:

```
//SYSLIB DD DSN=CEE.SCEELKEX,DISP=SHR
// DD DSN=CEE.SCEELKED,DISP=SHR
// DD DSN=CBC.SCCNOBJ,DISP=SHR
```

and you want to link each of the sample programs presented above (using NOXPLINK), here are the SYSLIB concatenations you would use:

### Sample 1

```
//SYSLIB DD DSN=CBC.SCCNN10,DISP=SHR
// DD DSN=CEE.SCEELKEX,DISP=SHR
// DD DSN=CEE.SCEELKED,DISP=SHR
// DD DSN=CBC.SCCNOBJ,DISP=SHR
```

### Sample 2

```
//SYSLIB DD DSN=CBC.SCCNM10,DISP=SHR
// DD DSN=CEE.SCEELKEX,DISP=SHR
// DD DSN=CEE.SCEELKED,DISP=SHR
// DD DSN=CBC.SCCNOBJ,DISP=SHR
```

### Sample 3

```
//SYSLIB DD DSN=CBC.SCCNN11,DISP=SHR
// DD DSN=CEE.SCEELKEX,DISP=SHR
// DD DSN=CEE.SCEELKED,DISP=SHR
// DD DSN=CBC.SCCNOBJ,DISP=SHR
```

### Sample 4

```
//SYSLIB DD DSN=CBC.SCCNN11,DISP=SHR
// DD DSN=CEE.SCEELKEX,DISP=SHR
// DD DSN=CEE.SCEELKED,DISP=SHR
// DD DSN=CBC.SCCNOBJ,DISP=SHR
```

### Sample 5

```
//SYSLIB DD DSN=CBC.SCCNM10,DISP=SHR
// DD DSN=CBC.SCCNN10,DISP=SHR
// DD DSN=CEE.SCEELKEX,DISP=SHR
// DD DSN=CEE.SCEELKED,DISP=SHR
// DD DSN=CBC.SCCNOBJ,DISP=SHR
```

If you wanted to link the above examples with XPLINK and/or LP64, you would include the exact same data sets for MASS, except your initial SYSLIB would have CEE.SCEEBND2 instead of CEE.SCEELKEX and CEE.SCEELKED.

```
//SYSLIB DD DSN=CEE.SCEEBND2,DISP=SHR
// DD DSN=CBC.SCCNOBJ
```

---

## Using the Automatically Tuned Linear Algebra Software (ATLAS) libraries

XL C/C++ compiler is shipped with a set of Automatically Tuned Linear Algebra Software (ATLAS) libraries for algebra high-performance computing.

This documentation is intended only as a high level description of ATLAS and the IBM specific extensions and naming convention. For more in depth information about ATLAS, consult the ATLAS documentation at <http://math-atlas.sourceforge.net/>

### Description and functionality provided

The ATLAS libraries contain all the Basic Linear Algebra Subprograms (BLAS) and a subset of the Linear Algebra Package (LAPACK) routines with interfaces provided for both C and Fortran F77 versions of the routines across platforms and architectures. Versions are provided and tuned herein for both the single-threaded and multi-threaded execution on IBM zEC12/zBC12 and IBM z13 hardware models. C and C++ calling programs are supported, with 31-bit C linkage, 31-bit XPLINK linkage, or 64-bit linkage.

**Note:** ATLAS is only provided as a USS package.

If you want to call ATLAS functionality in your program, take the following steps:

- Provide the prototype for the functions by including the appropriate header file (see “Supplied ATLAS libraries and their corresponding header files” on page 754 for header file names).
- Link with the appropriate ATLAS libraries (see “Supplied ATLAS libraries and their corresponding header files” on page 754 for library names).
- Use the appropriate compiler and linker flags (see “Required compiler options” on page 755).

## Supplied ATLAS libraries and their corresponding header files

**Note:** In the subsequent names, replace \* with any specific name (specific header file name or library file name).

The following main libraries are provided with ATLAS.

### ATLAS main library

ATLAS main library contains ATLAS specific variants of the BLAS, CBLAS, and LAPACK routines.

Table 333. Sample interface routine provided: *ATL\_dgemm*

Operation type	Library name for zEC12/zBC12	Library name for z13	Library location	Header files to be used with the library	Header file location
Single threaded	libatlas.arch10.a	libatlas.arch11.a	/usr/lpp/cbclib/lib/atlas	various atlas_*.h	/usr/lpp/cbclib/include/atlas
Multithreaded	libtatlas.arch10.a	libtatlas.arch11.a	/usr/lpp/cbclib/lib/atlas	various atlas_*.h	/usr/lpp/cbclib/include/atlas

### CBLAS library

CBLAS library contains the implementation of the C routines of the BLAS algorithms - also known as the CBLAS interface.

Table 334. Sample interface routine provided: *cbblas\_dgemm*

Operation type	Library name for zEC12/zBC12	Library name for z13	Library location	Header files to be used with the library	Header file location
Single threaded	libcbblas.arch10.a	libcbblas.arch11.a	/usr/lpp/cbclib/lib/atlas	cbblas.h	/usr/lpp/cbclib/include/atlas
Multithreaded	libtcbblas.arch10.a	libtcbblas.arch11.a	/usr/lpp/cbclib/lib/atlas	cbblas.h	/usr/lpp/cbclib/include/atlas

### LAPACK library

LAPACK library contains the implementation of the C routines of the LAPACK algorithms - also known as the CLAPACK interface.

Table 335. Sample interface routine provided: *clapack\_dgesv*

Operation type	Library name for zEC12/zBC12	Library name for z13	Library location	Header files to be used with the library	Header file location
Single threaded	liblapack.arch10.a	liblapack.arch11.a	/usr/lpp/cbclib/lib/atlas	clapack.h	/usr/lpp/cbclib/include/atlas
Multithreaded	libtlapack.arch10.a	libtlapack.arch11.a	/usr/lpp/cbclib/lib/atlas	clapack.h	/usr/lpp/cbclib/include/atlas

## Fortran BLAS library

Fortran BLAS library contains the implementation of the Fortran 77 routines of the BLAS algorithms - also known as the BLAS interface.

Table 336. Sample interface routine provided: `dgemm_`

Operation type	Library name for zEC12/zBC12	Library name for z13	Library location	Header files to be used with the library	Header file location
Single threaded	lib77blas.arch10.a	lib77blas.arch11.a	/usr/lpp/cbclib/lib/atlas	various atlas_*f77*.h	/usr/lpp/cbclib/include/atlas
Multithreaded	libt77blas.arch10.a	libt77blas.arch11.a	/usr/lpp/cbclib/lib/atlas	various atlas_*f77*.h	/usr/lpp/cbclib/include/atlas

### Notes:

1. For each of the above mentioned base libraries, the single-threaded and multi-threaded versions of the same base library contain the same list of functions.
2. Only static libraries are provided.
3. The libraries will archive 31-bit C linkage, 31-bit XPLink C linkage, and 64-bit C linkage objects. The linker, based on supplied options and/or environment variables will choose the appropriate archive members of specified libraries.

## Required compiler options

The following C/C++ compiler options are required to compile and link a program that utilizes ATLAS functionality:

- `FLOAT(IEEE)` - only IEEE floating point format is supported. Hexadecimal floating-point format is not supported.
- `ROUND(N)` - this is enabled by default when `FLOAT(IEEE)` is enabled.
- `ARCHITECTURE(10)` - the minimum required ARCH level. Higher ARCHITECTURE levels in future releases will also support ATLAS functionality.
- `ARCHITECTURE(11)` - required if you want to enable ATLAS vector functionality in your program.
- `VECTOR` - required if you want to enable ATLAS vector functionality in your program.
- `TARGET(zOSV2R1)` - the minimum required TARGET level. Higher TARGET levels in future releases will also support ATLAS functionality.

You might still be able to compile and link your ATLAS application without satisfying the above requirements, but the program will likely not give the correct results.

## Examples - Compiling, linking, and running a simple matrix multiplication ATLAS program

This simple sample achieves a multiplication of two matrices, A and B. A and B have elements randomly generated with values between 0 and 1. The multiplication is achieved in the following ways:

- by calling `dgemm/cblas_dgemm` BLAS functionality provided by ATLAS
- by a manual calculation of the same

The resulting matrices C and D will contain the same elements.

Sample output produced by all executables across all platforms and architectures should look like this:

```
Matrix A has 3 rows and 6 columns:
0.566 0.974 0.202 0.941 0.294 0.427
0.580 0.539 0.772 0.248 0.832 0.848
0.080 0.533 0.434 0.163 0.576 0.416

Matrix B has 6 rows and 4 columns:
0.309 0.316 0.569 0.182
0.725 0.389 0.472 0.649
0.448 0.368 0.354 0.665
0.994 0.740 0.649 0.616
0.133 0.906 0.447 0.590
0.773 0.774 0.893 0.913

Matrix C has 3 rows and 4 columns:
2.276 1.926 1.978 2.013
1.928 2.270 2.148 2.387
1.165 1.356 1.185 1.469

Matrix D has 3 rows and 4 columns:
2.276 1.926 1.978 2.013
1.928 2.270 2.148 2.387
1.165 1.356 1.185 1.469
```

Pay attention to the fact that matrices C and D are congruent.

Also note that matrix data is organized or ordered in the Fortran way, namely columns major.

## Sample 1

This program contains a C invocation of the Fortran BLAS function `dgemm_` provided by the ATLAS framework.

**Observation:** In this sample, the invocation of `dgemm_` has no previously declared prototype, hence the compiler might issue a warning message. Prototypes may be declared by including the `atlas_f77` header files, but source files might not have these header files specified (i.e. old source code written prior to ATLAS).

Source code:

```
#include <stdio.h>
#include <time.h>
#include <stdlib.h>

void init(double* matrix, int row, int column)
{
    for (int j = 0; j < column; j++){
        for (int i = 0; i < row; i++){
            matrix[j*row + i] = ((double)rand())/RAND_MAX;
        }
    }
}

void print(const char * name, const double* matrix, int row, int column)
{
    printf("Matrix %s has %d rows and %d columns:\n", name, row, column);
    for (int i = 0; i < row; i++){
        for (int j = 0; j < column; j++){
            printf("%.3f ", matrix[j*row + i]);
        }
        printf("\n");
    }
}
```

```

    }
    printf("\n");
}

int main(int argc, char * argv[])
{
    int rowsA, colsB, common;
    int i,j,k;

    if (argc != 4){
        printf("Using defaults\n");
        rowsA = 2; colsB = 4; common = 6;
    }
    else{
        rowsA = atoi(argv[1]); colsB = atoi(argv[2]); common = atoi(argv[3]);
    }

    double A[rowsA * common]; double B[common * colsB];
    double C[rowsA * colsB]; double D[rowsA * colsB];

    char transA = 'N', transB = 'N';
    double one = 1.0, zero = 0.0;

    srand(time(NULL));

    init(A, rowsA, common); init(B, common, colsB);

    dgemm_(&transA, &transB, &rowsA, &colsB, &common, &one, A,
          &rowsA, B, &common, &zero, C, &rowsA);

    for(i=0;i<colsB;i++){
        for(j=0;j<rowsA;j++){
            D[i*rowsA+j]=0;
            for(k=0;k<common;k++){
                D[i*rowsA+j]+=A[k*rowsA+j]*B[k+common*i];
            }
        }
    }

    print("A", A, rowsA, common); print("B", B, common, colsB);
    print("C", C, rowsA, colsB); print("D", D, rowsA, colsB);

    return 0;
}

```

To compile the program for ARCH(10):

```
xlc -c -qfloat=ieee -qground=n -qarch=10 -qtarget=zosv2r1 -I
/usr/lpp/cbclib/include/atlas -qfloat=ieee -o sample.o sample.c
```

To compile the program for ARCH(11) and higher ARCHITECTURE levels:

```
xlc -c -qfloat=ieee -qground=n -qarch=11 -qtarget=zosv2r1 -I
/usr/lpp/cbclib/include/atlas -qfloat=ieee -o sample.o sample.c
```

To link the program for ARCH(10):

```
xlc sample.o -L /usr/lpp/cbclib/lib/atlas -lf77blas.arch10
-latlas.arch10 -lf2c.arch10 -qfloat=ieee -o sample
```

To link the program for ARCH(11) and higher ARCHITECTURE levels:

```
xlc sample.o -L /usr/lpp/cbclib/lib/atlas -lf77blas.arch11
-latlas.arch11 -lf2c.arch11 -qfloat=ieee -o sample
```



## Sample 2

This program contains a C++ invocation of the Fortran BLAS function `dgemm_` provided by the ATLAS framework.

**Observation:** As opposed to sample 1, the compiler must be explicitly instructed that the function `dgemm_` has C linkage and thus no mangling should be attempted. This can be achieved either as specified, or by including the appropriate header file with the extern "C" designation.

Source code:

```
#include <stdio.h>
#include <time.h>
#include <stdlib.h>

extern "C"
{
    int dgemm_(char *, char *, int *, int *, int *, double *, double *, int *,
              double *, int *, double *, double *, int *);
}

void init(double* matrix, int row, int column)
{
    for (int j = 0; j < column; j++){
        for (int i = 0; i < row; i++){
            matrix[j*row + i] = ((double)rand())/RAND_MAX;
        }
    }
}

void print(const char * name, const double* matrix, int row, int column)
{
    printf("Matrix %s has %d rows and %d columns:\n", name, row, column);
    for (int i = 0; i < row; i++){
        for (int j = 0; j < column; j++){
            printf("%.3f ", matrix[j*row + i]);
        }
        printf("\n");
    }
    printf("\n");
}

int main(int argc, char * argv[])
{
    int rowsA, colsB, common;
    int i,j,k;

    if (argc != 4){
        printf("Using defaults\n");
        rowsA = 2; colsB = 4; common = 6;
    }
    else{
        rowsA = atoi(argv[1]); colsB = atoi(argv[2]); common = atoi(argv[3]);
    }

    double A[rowsA * common]; double B[common * colsB];
    double C[rowsA * colsB]; double D[rowsA * colsB];

    char transA = 'N', transB = 'N';
    double one = 1.0, zero = 0.0;

    srand(time(NULL));

    init(A, rowsA, common); init(B, common, colsB);
```

```

dgemm_(&transA, &transB, &rowsA, &colsB, &common, &one, A,
      &rowsA, B, &common, &zero, C, &rowsA);

for(i=0;i<colsB;i++){
  for(j=0;j<rowsA;j++){
    D[i*rowsA+j]=0;
    for(k=0;k<common;k++){
      D[i*rowsA+j]+=A[k*rowsA+j]*B[k+common*i];
    }
  }
}

print("A", A, rowsA, common); print("B", B, common, colsB);
print("C", C, rowsA, colsB); print("D", D, rowsA, colsB);

return 0;
}

```

To compile the program for ARCH(10):

```

xlc -c -qfloat=ieee -qround=n -qarch=10 -qtarget=zosv2r1 -I
/usr/lpp/cbclib/include/atlas -qfloat=ieee -o sample.o sample.C

```

To compile the program for ARCH(11) and higher ARCHITECTURE levels:

```

xlc -c -qfloat=ieee -qround=n -qarch=11 -qtarget=zosv2r1 -I
/usr/lpp/cbclib/include/atlas -qfloat=ieee -o sample.o sample.C

```

To link the program for ARCH(10):

```

xlc sample.o -L /usr/lpp/cbclib/lib/atlas -lf77blas.arch10
-latlas.arch10 -lf2c.arch10 -qfloat=ieee -o sample

```

To link the program for ARCH(11) and higher ARCHITECTURE levels:

```

xlc sample.o -L /usr/lpp/cbclib/lib/atlas -lf77blas.arch11
-latlas.arch11 -lf2c.arch11 -qfloat=ieee -o sample

```

### Sample 3

This program contains a C invocation of the CBLAS function `cbblas_dgemm_` provided by the ATLAS framework.

**Observation:** Same result and functionality as if `dgemm_` would be called, but this program uses the CBLAS version of the functions.

Source code:

```

#include <time.h>
#include <stdlib.h>
#include <cbblas.h>

void init(double* matrix, int row, int column)
{
  for (int j = 0; j < column; j++){
    for (int i = 0; i < row; i++){
      matrix[j*row + i] = ((double)rand())/RAND_MAX;
    }
  }
}

void print(const char * name, const double* matrix, int row, int column)
{
  printf("Matrix %s has %d rows and %d columns:\n", name, row, column);
  for (int i = 0; i < row; i++){
    for (int j = 0; j < column; j++){

```

```

        printf("%.3f ", matrix[j*row + i]);
    }
    printf("\n");
}
printf("\n");
}

int main(int argc, char * argv[])
{
    int rowsA, colsB, common;
    int i,j,k;

    if (argc != 4){
        printf("Using defaults\n");
        rowsA = 2; colsB = 4; common = 6;
    }
    else{
        rowsA = atoi(argv[1]); colsB = atoi(argv[2]); common = atoi(argv[3]);
    }

    double A[rowsA * common]; double B[common * colsB];
    double C[rowsA * colsB]; double D[rowsA * colsB];

    enum CBLAS_ORDER order = CblasColMajor;
    enum CBLAS_TRANSPOSE transA = CblasNoTrans;
    enum CBLAS_TRANSPOSE transB = CblasNoTrans;

    double one = 1.0, zero = 0.0;

    srand(time(NULL));

    init(A, rowsA, common); init(B, common, colsB);

    cblas_dgemm(order,transA,transB, rowsA, colsB, common ,1.0,A,
                rowsA ,B, common ,0.0,C, rowsA);

    for(i=0;i<colsB;i++){
        for(j=0;j<rowsA;j++){
            D[i*rowsA+j]=0;
            for(k=0;k<common;k++){
                D[i*rowsA+j]+=A[k*rowsA+j]*B[k+common*i];
            }
        }
    }

    print("A", A, rowsA, common); print("B", B, common, colsB);
    print("C", C, rowsA, colsB); print("D", D, rowsA, colsB);

    return 0;
}

```

To compile the program for ARCH(10):

```
xlc -c -qfloat=ieee -qground=n -qarch=10 -qtarget=zosv2r1 -I
/usr/lpp/cbclib/include/atlas -qfloat=ieee -o sample.o sample.c
```

To compile the program for ARCH(11) and higher ARCHITECTURE levels:

```
xlc -c -qfloat=ieee -qground=n -qarch=11 -qtarget=zosv2r1 -I
/usr/lpp/cbclib/include/atlas -qfloat=ieee -o sample.o sample.c
```

To link the program for ARCH(10):

```
xlc sample.o -L /usr/lpp/cbclib/lib/atlas -lcblas.arch10
-latlas.arch10 -qfloat=ieee -o sample
```

To link the program for ARCH(11) and higher ARCHITECTURE levels:

```
xlc sample.o -L /usr/lpp/cbclib/lib/atlas -lcblas.arch11
-latlas.arch11 -qfloat=ieee -o sample
```

## Sample 4

This program contains a C++ invocation of the CBLAS function `cblas_dgemm_` provided by the ATLAS framework.

**Observation:** Same result and functionality as if `dgemm_` would be called, but this program uses the CBLAS version of the functions.

Source code:

```
#include <time.h>
#include <stdlib.h>

extern "C"
{
#include <cblas.h>
}

void init(double* matrix, int row, int column)
{
    for (int j = 0; j < column; j++){
        for (int i = 0; i < row; i++){
            matrix[j*row + i] = ((double)rand())/RAND_MAX;
        }
    }
}

void print(const char * name, const double* matrix, int row, int column)
{
    printf("Matrix %s has %d rows and %d columns:\n", name, row, column);
    for (int i = 0; i < row; i++){
        for (int j = 0; j < column; j++){
            printf("%.3f ", matrix[j*row + i]);
        }
        printf("\n");
    }
    printf("\n");
}

int main(int argc, char * argv[])
{
    int rowsA, colsB, common;
    int i,j,k;

    if (argc != 4){
        printf("Using defaults\n");
        rowsA = 2; colsB = 4; common = 6;
    }
    else{
        rowsA = atoi(argv[1]); colsB = atoi(argv[2]); common = atoi(argv[3]);
    }

    double A[rowsA * common]; double B[common * colsB];
    double C[rowsA * colsB]; double D[rowsA * colsB];

    enum CBLAS_ORDER order = CblasColMajor;
    enum CBLAS_TRANSPOSE transA = CblasNoTrans;
    enum CBLAS_TRANSPOSE transB = CblasNoTrans;

    double one = 1.0, zero = 0.0;

    srand(time(NULL));
```

```

init(A, rowsA, common); init(B, common, colsB);

cblas_dgemm(order,transA,transB, rowsA, colsB, common ,1.0,A,
            rowsA ,B, common ,0.0,C, rowsA);

for(i=0;i<colsB;i++){
    for(j=0;j<rowsA;j++){
        D[i*rowsA+j]=0;
        for(k=0;k<common;k++){
            D[i*rowsA+j]+=A[k*rowsA+j]*B[k+common*i];
        }
    }
}

print("A", A, rowsA, common); print("B", B, common, colsB);
print("C", C, rowsA, colsB); print("D", D, rowsA, colsB);

return 0;
}

```

To compile the program for ARCH(10):

```

xlc -c -qfloat=ieee -qground=n -qarch=10 -qtarget=zosv2r1 -I
/usr/lpp/cbclib/include/atlas -qfloat=ieee -o sample.o sample.C

```

To compile the program for ARCH(11) and higher ARCHITECTURE levels:

```

xlc -c -qfloat=ieee -qground=n -qarch=11 -qtarget=zosv2r1 -I
/usr/lpp/cbclib/include/atlas -qfloat=ieee -o sample.o sample.C

```

To link the program for ARCH(10):

```

xlc sample.o -L /usr/lpp/cbclib/lib/atlas -lcblas.arch10
-latlas.arch10 -qfloat=ieee -o sample

```

To link the program for ARCH(11) and higher ARCHITECTURE levels:

```

xlc sample.o -L /usr/lpp/cbclib/lib/atlas -lcblas.arch11
-latlas.arch11 -qfloat=ieee -o sample

```

## Examples - Compiling, linking, and running a complex ATLAS sample

This section assumes that a complex test sample, `invtst.c`, ships with the ATLAS source code. This program is a complex sample that combines ATLAS specific, CBLAS, and LAPACK functionality that has to be compiled using the C compiler.

Example of ATLAS specific functions being called in this sample: `ATL_flushcache`, `ATL_assert`, `ATL_DivBySize`, and `ATL_MulBySize`.

Example of CBLAS specific functions being called in this sample: `cblas_asum`, `cblas_scasum`, `cblas_dzasum`, `cblas_copy`, `cblas_gemm`, `cblas_symm`, and `cblas_hemm`.

ATLAS header files being used: `atlas_misc.h`, `atlas_lapack.h`, `cblas.h`, `atlas_cblastypealias.h`, `atlas_tst.h`, `atlas_level3.h`, and `clapack.h`.

To compile `invtst.c` for ARCH(10):

```

xlc -c -qfloat=ieee -qground=n -qarch=10 -qtarget=zosv2r1 -I
/usr/lpp/cbclib/include/atlas -qLANGLVL=EXTC99 -DL2SIZE=4194304
-DAdd_DF77_INTEGER=int -DStringSunStyle -DATL_NCPU=20 -DATLCINT
-DSREAL -DWALL -DATL_CPUMHZ=5564 -DATL_OS_s390 -o invtst.o invtst.c

```

To compile `invtst.c` for ARCH(11) and higher ARCHITECTURE levels:

```
xlc -c -qfloat=ieee -qround=n -qarch=11 -qtarget=zosv2r1 -I
/usr/lpp/cbclib/include/atlas -qLANGVL=EXTC99 -DL2SIZE=4194304
-DAdd_ -DF77_INTEGER=int -DStringSunStyle -DATL_NCPU=20 -DATLCINT
-DSREAL -DWALL -DATL_CPUMHZ=5564 -DATL_OS_s390 -o invtst.o invtst.c
```

where:

- L2SIZE represents the size of the L2 cache on the target machine, namely the machine on which the executable will be run.
- Add\_, F77\_INTEGER, and StringSunStyle are Fortran defines outlining the inter-language interaction between C and Fortran code on z/OS.
- ATL\_NCPU represents the number of CPUs on the target hardware where the executable will be run.
- ATLCINT and SREAL are ATLAS specific defines.
- WALL instructs the ATLAS framework to issue all possible warnings.
- ATL\_CPUMHZ represents the speed of the target architecture where the executable will be run.
- ATL\_OS\_s390 instructs ATLAS that a z/OS operating system is used for compile operations.

To link the program for ARCH(10):

```
xlc invtst.o -L /usr/lpp/cbclib/lib/atlas -ltstatlas.arch10
-llapack.arch10 -lcbblas.arch10 -lf77blas.arch10 -latlas.arch10
-lf2c.arch10 -o invtst
```

To link the program for ARCH(11) and higher ARCHITECTURE levels:

```
xlc invtst.o -L /usr/lpp/cbclib/lib/atlas -ltstatlas.arch11
-llapack.arch11 -lcbblas.arch11 -lf77blas.arch11 -latlas.arch10
-lf2c.arch11 -o invtst
```

When ran, the executable will produce the following output:

NREPS	ORDER	UPLO	N	LDA	TIME	MFLOP	RESID
=====	=====	=====	=====	=====	=====	=====	=====
0	Co1	GE	100	100	0.027	73.97	8.918092e-03
0	Co1	GE	200	200	0.005	3024.80	6.950735e-03
0	Co1	GE	300	300	0.015	3535.71	8.034554e-03
0	Co1	GE	400	400	0.034	3783.16	9.250009e-03
0	Co1	GE	500	500	0.063	3937.21	7.678587e-03
0	Co1	GE	600	600	0.107	4046.78	9.520883e-03
0	Co1	GE	700	700	0.167	4097.17	8.519278e-03
0	Co1	GE	800	800	0.247	4148.75	8.575264e-03
0	Co1	GE	900	900	0.346	4217.16	1.272196e-02
0	Co1	GE	1000	1000	0.471	4247.66	8.753754e-03

10 cases: 10 passed, 0 skipped, 0 failed

## Related external information

For details about the ATLAS libraries, such as lists of functions included in the various libraries, visit the Automatically Tuned Linear Algebra Software website at <http://math-atlas.sourceforge.net>.



---

## Chapter 44. Parallelizing your programs

The z/OS XL C/C++ compiler offers you the following method of implementing shared memory program parallelization:

- Explicit parallelization of C and C++ program code using pragma directives compliant to the OpenMP Application Program Interface specification. An overview of the OpenMP directives is provided in “Using OpenMP directives.”

Program parallelization is enabled when the **SMP** compiler option is in effect. The thread-safe version of system library routines should be used inside the parallel regions.

Parallel regions of program code are executed by multiple threads, possibly running on multiple processors. The number of threads created is determined by environment variables and calls to library functions. Work is distributed among available threads according to scheduling algorithms specified by the environment variables. If you are using OpenMP constructs, you can use the OpenMP environment variables to control thread scheduling.

For information about OpenMP runtime functions, see “OpenMP runtime functions for parallel processing” on page 768.

For detailed description of the OpenMP directives, see Pragma directives for parallel processing in *z/OS XL C/C++ Language Reference*.

For information about OpenMP environment variables, see Environment variables for OpenMP in *z/OS XL C/C++ User's Guide*.

For details about the OpenMP constructs, environment variables, and runtime routines, refer to the *OpenMP Application Program Interface Specification*, available at <http://www.openmp.org>.

---

### Using OpenMP directives

OpenMP directives exploit shared memory parallelism by defining various types of parallel regions. Parallel regions can include both iterative and non-iterative segments of program code.

The **#pragma omp** pragmas fall into the following general categories:

1. The **#pragma omp** pragmas for defining parallel regions in which work is done by threads in parallel (**#pragma omp parallel**). Most of the OpenMP directives either statically or dynamically bind to an enclosing parallel region.
2. The **#pragma omp** pragmas for defining how work is distributed or shared across the threads in a parallel region (**#pragma omp sections**, **#pragma omp for**, **#pragma omp single**, **#pragma omp task**).
3. The **#pragma omp** pragmas for controlling synchronization among threads (**#pragma omp atomic**, **#pragma omp master**, **#pragma omp barrier**, **#pragma omp critical**, **#pragma omp flush**, **#pragma omp ordered**).
4. The **#pragma omp** pragmas for defining the scope of data visibility across parallel regions within the same thread (**#pragma omp threadprivate**).



5. The `#pragma omp` pragmas for synchronization (`#pragma omp taskwait`, `#pragma omp barrier`)

### OpenMP directive syntax

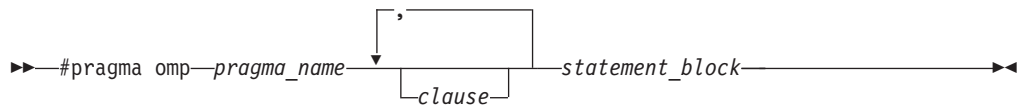

Including clauses in the `#pragma omp` pragmas can fine tune the behavior of the parallel or work-sharing regions. For example, a `num_threads` clause can be used to control a parallel region pragma.

The `#pragma omp` pragmas generally appear immediately before the section of code to which they apply. The following code defines a parallel region in which iterations of a for loop can run in parallel:

```
#pragma omp parallel
{
  #pragma omp for
  for (i=0; i<n; i++)
    ...
}
```

The following example defines a parallel region in which two or more non-iterative sections of program code can run in parallel:

```
#pragma omp parallel
{
  #pragma omp sections
  {
    #pragma omp section
    structured_block_1
    ...
    #pragma omp section
    structured_block_2
    ...
  }
}
```

For detailed description of the OpenMP directives, see Pragma directives for parallel processing in *z/OS XL C/C++ Language Reference*.

---

## Shared and private variables in a parallel environment

Variables can have either shared or private context in a parallel environment. Variables in shared context are visible to all threads running in associated parallel regions. Variables in private context are hidden from other threads. Each thread has its own private copy of the variable, and modifications made by a thread to its copy are not visible to other threads.

The default context of a variable is determined by the following rules:

- Variables with `static` storage duration are shared.
- Dynamically allocated objects are shared.
- Variables with automatic storage duration that are declared in a parallel region are private.

- Variables in heap allocated memory are shared. There can be only one shared heap.
- All variables defined outside a parallel construct become shared when the parallel region is encountered.
- Loop iteration variables are private within their loops. The value of the iteration variable after the loop is the same as if the loop were run sequentially.
- Memory allocated within a parallel loop by the `alloca` function persists only for the duration of one iteration of that loop, and is private for each thread.

The following code segments show examples of these default rules:

```
int E1;                                /* shared static */

void main (argc,...) {                 /* argc is shared */
    int i;                             /* shared automatic */

    void *p = malloc(...);            /* memory allocated by malloc */
                                        /* is accessible by all threads */
                                        /* and cannot be privatized */

#pragma omp parallel firstprivate (p)
{
    int b;                             /* private automatic */
    static int s;                      /* shared static */

    #pragma omp for
    for (i =0;...) {
        b = 1;                         /* b is still private here ! */
        foo (i);                       /* i is private here because it */
                                        /* is an iteration variable */
    }

#pragma omp parallel
{
    b = 1;                             /* b is shared here because it */
                                        /* is another parallel region */
}
}

int E2;                                /*shared static */

void foo (int x) {                    /* x is private for the parallel */
                                        /* region it was called from */

int c;                                /* the same */
... }

```

Some OpenMP clauses enable you to specify visibility context for selected data variables. A brief summary of data scope attribute clauses are listed below:

Data scope attribute clause	Description
private	The <b>private</b> clause declares the variables in the list to be private to each thread in a team.
firstprivate	The <b>firstprivate</b> clause provides a superset of the functionality provided by the private clause. The private variable is initialized by the original value of the variable when the parallel construct is encountered.

Data scope attribute clause	Description
lastprivate	The <b>lastprivate</b> clause provides a superset of the functionality provided by the private clause. The private variable is updated after the end of the parallel construct.
shared	The <b>shared</b> clause declares the variables in the list to be shared among all the threads in a team. All threads within a team access the same storage area for shared variables.
reduction	The <b>reduction</b> clause performs a reduction on the scalar variables that appear in the list, with a specified operator.
default	The <b>default</b> clause allows the user to affect the data-sharing attribute of the variables appeared in the parallel construct.

For more information, you can also refer to the *OpenMP Application Program Interface Language Specification*, which is available at <http://www.openmp.org>.

---

## OpenMP runtime functions for parallel processing

Function definitions for the `omp_` functions can be found in the `omp.h` header file.

For complete information about OpenMP runtime library functions, refer to the OpenMP Application Program Interface specification at [www.openmp.org](http://www.openmp.org).

### **omp\_destroy\_lock, omp\_destroy\_nest\_lock**

#### **Purpose**

Ensures that the specified lock variable *lock* is uninitialized.

#### **Prototype**

```
void omp_destroy_lock (omp_lock_t *lock);

void omp_destroy_nest_lock (omp_nest_lock_t *lock);
```

#### **Parameter**

*lock*

Must be a variable of type `omp_lock_t` that is initialized with `omp_init_lock` or `omp_init_nest_lock`.

### **omp\_get\_active\_level**

#### **Purpose**

Returns the number of nested, active parallel regions enclosing the task that contains the call. The routine always returns a nonnegative integer, and returns 0 if it is called from the sequential part of the program.

#### **Prototype**

```
int omp_get_active_level(void);
```

## **omp\_get\_ancestor\_thread\_num**

### **Purpose**

Returns the thread number of the ancestor of the current thread at a given nested level. Returns -1 if the nested level is not within the range of 0 and the current thread's nested level as returned by **omp\_get\_level**.

### **Prototype**

```
int omp_get_ancestor_thread_num(int level);
```

### **Parameter**

*level*

Specifies a given nested level of the current thread.

## **omp\_get\_dynamic**

### **Purpose**

Returns non-zero if dynamic thread adjustment is enabled and returns 0 otherwise.

### **Prototype**

```
int omp_get_dynamic (void);
```

## **omp\_get\_level**

### **Purpose**

Returns the number of active and inactive nested parallel regions that the generating task is executing in. This does not include the implicit parallel region. Returns 0 if it is called from the sequential part of the program. Otherwise, returns a nonnegative integer.

### **Prototype**

```
int omp_get_level(void);
```

## **omp\_get\_max\_active\_levels**

### **Purpose**

Returns the value of the *max-active-levels-var* internal control variable that determines the maximum number of nested active parallel regions. *max-active-levels-var* can be set with the `OMP_MAX_ACTIVE_LEVELS` environment variable or the **omp\_set\_max\_active\_levels** runtime routine.

### **Prototype**

```
int omp_get_max_active_levels(void);
```

## **omp\_get\_max\_threads**

### **Purpose**

Returns the first value of *num\_list* for the `OMP_NUM_THREADS` environment variable. This value is the maximum number of threads that can be used to form a

new team if a parallel region without a **num\_threads** clause is encountered.

### Prototype

```
int omp_get_max_threads (void);
```

## omp\_get\_nested

### Purpose

Returns non-zero if nested parallelism is enabled and 0 if it is disabled.

### Prototype

```
int omp_get_nested (void);
```

## omp\_get\_num\_procs

### Purpose

Returns the maximum number of processors that could be assigned to the program.

### Prototype

```
int omp_get_num_procs (void);
```

## omp\_get\_num\_threads

### Purpose

Returns the number of threads currently in the team executing the parallel region from which it is called.

### Prototype

```
int omp_get_num_threads (void);
```

## omp\_get\_schedule

### Purpose

Returns the *run-sched-var* internal control variable of the team that is processing the parallel region. The argument *kind* returns the type of schedule that will be used. *modifier* represents the chunk size that is set for applicable schedule types. *run-sched-var* can be set with the *OMP\_SCHEDULE* environment variable or the **omp\_set\_schedule** function.

### Prototype

```
int omp_get_schedule(omp_sched_t * kind, int * modifier);
```

### Parameters

*kind*

The value returned for *kind* is one of the schedule types affinity, auto, dynamic, guided, runtime, or static.

*modifier*

For the schedule type dynamic, guided, or static, *modifier* is the chunk size that is set. For the schedule type auto, *modifier* has no meaning.

## **omp\_get\_team\_size**

### **Purpose**

Returns the thread team size that the ancestor or the current thread belongs to. **omp\_get\_team\_size** returns -1 if the nested level is not within the range of 0 and the current thread's nested level as returned by **omp\_get\_level**.

### **Prototype**

```
int omp_get_team_size(int level);
```

### **Parameter**

*level*

Specifies a given nested level of the current thread.

## **omp\_get\_thread\_limit**

### **Purpose**

Returns the maximum number of OpenMP threads available to the program. The value is stored in the *thread-limit-var* internal control variable. *thread-limit-var* can be set with the *OMP\_THREAD\_LIMIT* environment variable.

### **Prototype**

```
int omp_get_thread_limit(void);
```

## **omp\_get\_thread\_num**

### **Purpose**

Returns the thread number, within its team, of the thread executing the function.

### **Prototype**

```
int omp_get_thread_num (void);
```

### **Return value**

The thread number lies between 0 and `omp_get_num_threads()-1`, inclusive. The master thread of the team is thread 0.

## **omp\_get\_wtick**

### **Purpose**

Returns the number of seconds between clock ticks.

### **Prototype**

```
double omp_get_wtick (void);
```

## Usage

The value of the fixed starting time is determined at the start of the current program, and remains constant throughout program execution.

## **omp\_get\_wtime**

### Purpose

Returns the time elapsed from a fixed starting time.

### Prototype

```
double omp_get_wtime (void);
```

## Usage

The value of the fixed starting time is determined at the start of the current program, and remains constant throughout program execution.

## **omp\_in\_final**

### Purpose

Returns a nonzero integer value if the function is called in a final task region; otherwise, it returns 0.

### Prototype

```
int omp_in_final(void);
```

## **omp\_in\_parallel**

### Purpose

Returns non-zero if it is called within the dynamic extent of a parallel region executing in parallel; otherwise, returns 0.

### Prototype

```
int omp_in_parallel (void);
```

## **omp\_init\_lock, omp\_init\_nest\_lock**

### Purpose

Initializes the lock associated with the parameter *lock* for use in subsequent calls.

### Prototype

```
void omp_init_lock (omp_lock_t *lock);
```

```
void omp_init_nest_lock (omp_nest_lock_t *lock);
```

### Parameter

*lock*

Must be a variable of type `omp_lock_t`.

## omp\_set\_dynamic

### Purpose

Enables or disables dynamic adjustment of the number of threads available for execution of parallel regions.

### Prototype

```
void omp_set_dynamic (int dynamic_threads);
```

### Parameter

*dynamic\_threads*

Indicates whether the number of threads available in subsequent parallel region can be adjusted by the runtime. If *dynamic\_threads* is nonzero, the runtime can adjust the number of threads. If *dynamic\_threads* is zero, the runtime cannot dynamically adjust the number of threads.

## omp\_set\_lock, omp\_set\_nest\_lock

### Purpose

Blocks the thread executing the function until the specified lock is available and then sets the lock.

### Prototype

```
void omp_set_lock (omp_lock_t * lock);
```

```
void omp_set_nest_lock (omp_nest_lock_t * lock);
```

### Parameter

*lock*

Must be a variable of type `omp_lock_t` that is initialized with `omp_init_lock` or `omp_init_nest_lock`.

### Usage

A simple lock is available if it is unlocked. A nestable lock is available if it is unlocked or if it is already owned by the thread executing the function.

## omp\_set\_max\_active\_levels

### Purpose

Sets the value of the *max-active-levels-var* internal control variable to the value in the argument. If the number of parallel levels requested exceeds the number of the supported levels of parallelism, the value of *max-active-levels-var* is set to the number of parallel levels supported by the runtime. If the number of parallel levels requested is not a positive integer, this routine call is ignored.

When nested parallelism is turned off, this routine has no effect and the value of *max-active-levels-var* remains 1. *max-active-levels-var* can also be set with the `OMP_MAX_ACTIVE_LEVELS` environment variable. To retrieve the value for *max-active-levels-var*, use the `omp_get_max_active_levels` function.



Use `omp_set_max_active_levels` only in serial regions of a program. This routine has no effect in parallel regions of a program.

### Prototype

```
void omp_set_max_active_levels(int max_levels);
```

### Parameter

#### **max\_levels**

An integer that specifies the maximum number of nested, active parallel regions.

## **omp\_set\_nested**

### Purpose

Enables or disables nested parallelism.

### Prototype

```
void omp_set_nested (int nested);
```

### Usage

If the argument to `omp_set_nested` evaluates to true, nested parallelism is enabled for the current task; otherwise, nested parallelism is disabled for the current task. The setting of `omp_set_nested` overrides the setting of the `OMP_NESTED` environment variable.

**Note:** If the number of threads from all regions exceeds the number of available processors, your program might suffer performance degradation.

## **omp\_set\_num\_threads**

### Purpose

Overrides the setting of the `OMP_NUM_THREADS` environment variable, and specifies the number of threads to use for a subsequent parallel region by setting the first value of `num_list` for `OMP_NUM_THREADS`.

### Prototype

```
void omp_set_num_threads (int num_threads);
```

### Parameters

#### *num\_threads*

Must be a positive integer.

### Usage

If the `num_threads` clause is present, then for the parallel region it is applied to, it supersedes the number of threads requested by this function or the `OMP_NUM_THREADS` environment variable. Subsequent parallel regions are not affected by it.

## omp\_set\_schedule

### Purpose

Sets the value of the *run-sched-var* internal control variable. Use **omp\_set\_schedule** if you want to set the schedule type separately from the *OMP\_SCHEDULE* environment variable.

### Prototype

```
void omp_set_schedule (omp_sched_t kind, int modifier);
```

### Parameters

*kind*

Must be one of the schedule types affinity, auto, dynamic, guided, runtime, or static.

*modifier*

For the schedule type dynamic, guided, or static, *modifier* is the chunk size that you want to set. Generally it is a positive integer. If the value is less than one, the default will be used. For the schedule type auto, *modifier* has no meaning.

### Related reference:

“omp\_get\_schedule” on page 770

## omp\_test\_lock, omp\_test\_nest\_lock

### Purpose

Attempts to set a lock but does not block execution of the thread.

### Prototype

```
int omp_test_lock (omp_lock_t * lock);
```

```
int omp_test_nest_lock (omp_nest_lock_t * lock);
```

### Parameter

*lock*

Must be a variable of type *omp\_lock\_t* that is initialized with *omp\_init\_lock* or *omp\_init\_nest\_lock*.

## omp\_unset\_lock, omp\_unset\_nest\_lock

### Purpose

Releases ownership of a lock.

### Prototype

```
void omp_unset_lock (omp_lock_t * lock);
```

```
void omp_unset_nest_lock (omp_nest_lock_t * lock);
```

## Parameter

*lock*

Must be a variable of type `omp_lock_t` that is initialized with `omp_init_lock` or `omp_init_nest_lock`.

---

## Chapter 45. Optimizing the system and Language Environment

This chapter gives some basic tips for tuning Language Environment for optimal C/C++ performance, and some basic system setup tips for efficient program execution.

---

### Improving the performance of the Language Environment

This section discusses how to increase the performance of an application by:

- “Storing libraries and modules in system memory”
- “Optimizing memory and storage”
- “Optimizing runtime options” on page 778

#### Storing libraries and modules in system memory

One way to boost performance is to load common or reusable modules into memory. For example, placing the Language Environment Library in a link pack area (LPA) can increase the performance of your entire system. This is recommended if your z/OS system contains many applications that use the Language Environment Library, or is a heavy user of z/OS UNIX. LPAs store reentrant routines from system libraries. This saves loading time when a reentrant routine is needed. Individual modules can also be loaded into a single LIBPACK, in order to reduce the time that would otherwise be needed to load the individual load modules. For instructions for placing Language Environment Modules in Link Pack and LIBPACK, see *z/OS Language Environment Customization*.

If LPAs or LIBPACKS do not have enough space for the Language Environment Library, then you can place it into a library lookaside (LLA). This reduces library I/O activity by keeping selected directory entries in storage.

Similarly, if your application uses C++ class libraries, then application performance may be increased by placing specific libraries in the LPA or the dynamic link pack area (DLPA). For example:

- If the application is a heavy user of the C++ ANSI Standard Libraries, then place the 31-bit CEE.SCEERUN2(C128) or 64-bit CEE.SCEERUN2(C64) Language Environment runtime library in the DLPA.
- If the application is using the non-XPLINK C++ standard library, then place the CEE.SCEERUN(C128N) Language Environment runtime library in an LPA.
- If the application is a heavy user of the USL IOSTREAM libraries, then place the CBC.SCLBDLL Language Environment runtime library in an LPA (for non-XPLINK applications) or the CBC.SCLBDLL2 Language Environment runtime library in a DLPA (for XPLINK applications).

#### Optimizing memory and storage

Memory allocations can significantly affect the performance of your application. You can optimize your runtime space requirements by using the following Language Environment runtime options:

ANYHEAP                      BELOWHEAP                      HEAP                      HEAPPOOLS

LIBSTACK	STACK	STORAGE	THREADSTACK
HEAP64	HEAPPOOLS64	STACK64	THREADSTACK64

Stack extensions can also cause significant performance hits. For this reason:

- The STACK/STACK64 specified should be large enough to ensure that a stack extension never occurs during the execution of the program.
- The HEAP/HEAP64 should be large enough for an average application execution run, and the increment size should be a reasonable portion of the difference between the typical heap used and the maximum amount of heap that may be used.
- Use the RPTSTG(ON) Language Environment runtime option or the `__heaprpt()` function to determine the storage usage and the option settings for the given run of your application. The generated report will show if the ANYHEAP, BELOWHEAP, LIBSTACK, and THREADSTACK/THREADSTACK64 are set to the recommended values. The STACK/STACK64 and HEAP/HEAP64 defaults should be as specified above.

The RPTSTG(ON) option should not be used in the final build or run because it is resource-intensive, which adversely affects the performance of the application. The `__heaprpt()` function, which does not require the RPTSTG(ON) option, obtains a summary heap storage report while your application is running. For more information, see `__heaprpt()` in *z/OS XL C/C++ Runtime Library Reference*.

You can also tune I/O storage by using the `_EDC_STOR_INITIAL` and `_EDC_STOR_INCREMENT` environment variables. The I/O storage usage is not in the storage report.

For more information about runtime storage, see Stack and heap storage in *z/OS Language Environment Programming Guide*

## Optimizing runtime options

In addition to the memory options, the ALL31 and HEAPP0OLS runtime options can improve the performance of your application. ALL31 indicates that a Language Environment application has a 31-bit addressing mode. The Language Environment default is ALL31(ON). If your application has some AMODE 24 components, you will need to run the application with ALL31(OFF), but will lose some performance.

The HEAPP0OLS runtime option might increase storage use, but will improve the performance of the application. This option is effective if:

- The application is multi-threaded
- The application often uses:
  - `new()`
  - `delete()`
  - `new[]()`
  - `delete[]()`
  - `malloc()`
  - `__malloc31()`
  - `realloc()`
  - `calloc()`
  - `free()`

**Note:** If you are not sure which settings of ALL31 and HEAPP00LS are in effect, use the Language Environment runtime option RPTOPTS. RPTOPTS(ON) generates a report of runtime options and their settings that are in use by the currently-running application. Because this option diminishes the performance of the application, it should be used for diagnosis purposes only.

---

## Tuning the system for efficient execution

This section is a quick overview of a ways to preload modules, DLLs, files, and directories into z/OS. In general, preloading reduces overhead and memory cost. For more detailed information, see the following documents:

- *z/OS UNIX System Services Planning*
- *z/OS MVS Initialization and Tuning Guide*

### Link pack areas

It is recommended that you preload items that are either critical or frequently used into the link pack area (LPA). For batch and z/OS UNIX tasks, use LPA for modules or dynamic LPA for program objects. If LPA is not an option due to system requirements, then consider putting the module into LLA.

IMS and CICS both have similar methods to allow you to preload a frequently used module.

### Library lookasides

The library lookaside facility (LLA) reduces the amount of I/O activity necessary to locate and fetch modules and program objects from storage. In addition, LLA can work with virtual lookasides to quickly fetch modules from virtual storage instead of from a direct access storage device (DASD).

### Virtual lookasides

The virtual lookaside facility (VLF) is used to cache various items to reduce I/O, reduce CPU time, and increase response time. For example, you can cache the user IDs (UIDs) and group IDs (GIDs), which will reduce the DASD I/O overhead for Resource Access Control Facility (RACF) calls.



---

## Chapter 46. Balancing compilation time and application performance

Compilation time increases as the level of optimization increases. An end user requires that an application run as fast as possible, and therefore will compile with the maximum optimization possible. Conversely, a developer rebuilds an application many times while debugging a problem, and therefore will compile with the minimum optimization possible. In addition, a developer might need to implement debugging tools, or activate extra debugging code, both of which would affect the performance of the application. This information discusses how to determine the proper balance between compilation time and application performance.

---

### General tips

The following list contains suggestions to support your efforts to debug programs, and reduce compilation time, and improve application performance.

- All builds for testing or production should be compiled with the optimization level at which you intend to ship the final product.
- Even if you compile with `opt(0)` and debug on a regular basis, you should also do some testing at higher optimization levels to ensure that no aliasing rules or ANSI rules have been broken, which would cause the code to be optimized incorrectly.
- You can ensure the cleanest possible optimized compilations, as well as reduce the number of bugs that occur only at high optimization levels, by reviewing every warning issued by the compiler.

**Note:** Warnings are often a sign that the compiler is not sure how to interpret the code. If the compiler is not sure how to interpret code at `Opt(0)`, the code could cause an error at higher optimization levels or contribute to longer compilation times.

- The simpler the code is, the more easily the compiler can understand it and the faster it will compile. For more information, see Chapter 39, “Improving program performance,” on page 695.
- The `CHECKOUT` (for C) or `INF0`(for C++) option can be used to look for certain common problems (such as unprototyped functions and uninitialized variables) that can increase both compilation time and execution time.
- Generate production builds each week throughout the project cycle. This makes it easier to determine when problems entered the code base. Waiting until the end of a cycle to generate a build with high optimization can make it more difficult to find errors caused by coding that does not conform to ANSI aliasing rules.
- Set up a build so that you can customize options for any source file, if necessary. For example, use a makefile for a UNIX System Services-based build with a default rule for compilation. You can then customize targets for source files that require different options. Similarly, use the `OPTFILE` compiler option for a JCL-based build. A build script can then use a project-level option file for all source files in a module or DLL. You can specify either of the following:
  - Both a project-level option file and additional specific options for a source file



- A source-specific option file in the option list that follows the options file name
- Set up build scripts so that they can be used for both development and production builds to:
  - Eliminate a common source of errors (because it is necessary to update only one build environment)
  - Make it easier to reproduce and debug problems that occur only in the development build
  - Minimize occurrences of bugs that are reproducible only in the development build

---

## Programmer tips

- You can add code to the beginning and end of a header file to ensure that it is not processed unnecessarily during compilation.

The following example contains code that is included in a header file called myheader.

```
#ifndef __myheader
#ifdef __COMPILER_VER__
#pragma filetag ("IBM-1047")
#endif
#define __myheader 1
.
.
. /* header file contents */
#endif
```

You must ensure that the `filetag` statement, if used, appears before the first statement or directive (except for any conditional compilation directives). The `ifndef` statement is the first non-comment statement in the header file (the actual token used after the `ifndef` statement is your choice). The `define` statement must follow; it cannot appear before the `filetag` statement, but it must appear before any other preprocessor statement (other than comments).

Note that the header can contain comment statements in any location. Using this format of header-file blocking will improve compilation time for programs where a header file is included more than once.

- Use the system header files from UNIX file system instead of partitioned data sets to improve compilation time. Specify the following compiler options to do this:

**For C++**

```
NOSEARCH SEARCH('/usr/include/', '/usr/lpp/cbclib/include/')
```

**For C** NOSEARCH SEARCH('/usr/include/')

- With the `MEMORY` compiler option (the default), the compiler uses a hiperspace or memory file in place of a work file (if possible). This option increases compilation speed, but you might require additional memory to use it. If the compilation fails because of a storage error, either increase your storage size or recompile your program using the `NOMEMORY` option.
- If your file has many recursive template definitions and you want to use the `TEMPINC` option, the `FASTTEMPINC` compiler option might reduce the compilation time.

**Note:** This option defers generating object code until the final versions of all template definitions have been determined. Then, a single compilation pass generates the final object code. Time is not wasted generating object code that will be discarded and generated again.

If your application has very few recursive template definitions, `NOFASTTEMPINC` might be faster than `FASTTEMPINC`.

- If you want to achieve a good balance of compilation time and small modules that execute quickly, consider using the `TEMPLATEREGISTRY` option instead of `TEMPINC` or `NOTEMPINC`.
- If a source file does not have try/catch blocks or does not throw objects, then the `NOEXH C++` compiler option may improve the compilation time. The resultant code will not be ANSI-compliant if the program uses exception handling.
- If you want to improve your `OPT` compilation time at the expense of runtime performance, you can specify:

#### **MAXMEM**

Limits the amount of memory used for local tables of specific memory intensive optimizations. If this amount of memory is insufficient for a particular optimization, the compiler performs somewhat poorer optimization and issues a warning message. Reducing the `MAXMEM` value from 2G to 10M may disable some optimizations, which may cause some decrease in execution performance.

#### **NOINLINE**

Disables inlining, which might decrease the compilation time. There might also be a corresponding increase in execution time.

---

## **System programmer tips**

- If you do a lot of application development on your machine, put the compiler and runtime library in the LPA. Similarly, if you are working in z/OS UNIX System Services also put the `c89/cxx/cc` utilities in the dynamic LPA, LPA or linklist.
- Use packs that are cached with DASD fast write.  
If you are working in z/OS UNIX System Services, give each user a separate mountable file system to avoid I/O contention.  
If the compiler is not in LPA, tune your jobs to avoid channel and pack contention when the headers and the compiler are on the same pack and multiple compile jobs are executing.
- If you use the `makedepend` utility to generate dependency information, use the `LIST` option to generate a listing from `makedepend`. The summary section of this listing shows a list of the most frequently called headers and the frequency of these calls. Use this information to determine which headers should be cached.
- You can define `/tmp` as a RAM disk by specifying:  
`FILESYSTYPE TYPE(TFS) ENTRYPOINT(BPXTFS)`  
This is described in more detail in *z/OS UNIX System Services Planning*.



---

## Chapter 47. Stepping through optimized code using the dbx debugger utility

Starting from z/OS V2R1, debug information can be generated for optimized code. The debugger can do normal debugging with code that is compiled with the OPTIMIZE(2) and DEBUG(LEVEL(8)) compiler options.

However, the debug information generated for code compiled with OPTIMIZE(3) and higher levels is limited. You can use the dbx debugger utility to help you determine problems. One method is to set the stop location at the point where your program detects an error situation, or detects a severe condition, which the code cannot handle. This method has the following limitations:

- The point at which you want to allow dbx to take control must be determined prior to compile time.
- You can use the dbx **stepi** subcommand to step through the code at the instruction level only.
- No source or symbolic debug information is available, which means that the debugger cannot execute any instructions that require debug information, such as relating the execution to the source file or examining the values of variables.

For more information on dbx, and the dbx **stop** and **stepi** subcommands, refer to *z/OS UNIX System Services Command Reference*. For information on the OPTIMIZE, NOOPTIMIZE, and DEBUG compiler options, see *z/OS XL C/C++ User's Guide*

---

### Steps for setting up a stopping point for dbx in optimized code

Perform the following steps to set up a stopping point for dbx in optimized code:

1. Create a source file named `a.c`, with a function `func()` defined in it.
2. At any point in the application (in any file, in any function compiled with OPTIMIZE), insert `func();` where you want to allow the debugger to take control.

```
main.c
main() { /* or insert anywhere in the application, */
        /* in any file, in any function compiled at OPT. */
        ...
        func();
        ...
    }
```

3. Compile `main.c` with the OPTIMIZE compiler option.
4. Compile `a.c` with the DEBUG and NOOPTIMIZE compiler options.
5. Relink the application, together with the newly created `a.o` object file.

---

### Steps for setting up a stopping point for dbx in optimized code

Perform the following steps to use dbx to step through optimized code:

1. Load the `a.out` file into the `dbx` utility (`a.out` is the default name of an executable file produced by the compiler.)
2. Use the `dbx` **stop** subcommand to stop in `func()`.
3. Use the `dbx` **run** or **continue** subcommand to resume `dbx` so that it can hit the entry breakpoint for `func()`.
4. Use the `dbx` **stepi** subcommand to return to the point in the original source where the call to `func()` was inserted.

For more information on `dbx`, and the `dbx` `stop` and `stepi` subcommands, see *z/OS UNIX System Services Command Reference*. For information on the `OPTIMIZE`, `NOOPTIMIZE`, and `DEBUG` compiler options, see *z/OS XL C/C++ User's Guide*.

---

## Part 6. z/OS XL C/C++ Environments

This part describes the different z/OS XL C/C++ environments. Note that the MultiTasking Facility and the System Programming C Facilities are not available for z/OS XL C++. If you attempt to run an SPC application under z/OS XL C++, it will abend.

- Chapter 48, "Using the system programming C facilities," on page 789
- Chapter 49, "Library functions for system programming C," on page 831
- Chapter 50, "Using runtime user exits," on page 837
- Chapter 51, "Using the z/OS XL C MultiTasking Facility," on page 855



---

## Chapter 48. Using the system programming C facilities

This chapter explains how to use the system programming C (SPC) facilities with z/OS XL C.

### Notes:

1. Using the system programming C facilities, by programs which have been compiled with z/OS XL C++ is not supported.
2. IPA is not supported in an SPC environment unless there is a main() function present.
3. XPLINK is not supported by the SPC facilities.
4. AMODE 64 applications are not supported by the SPC facilities.

When z/OS XL C applications are compiled, many routines are needed to support the z/OS XL C environment that are not included in your executable. These routines, which are in z/OS Language Environment, are dynamically loaded at run time. This reduces the size of the program to its practical minimum and provides for the sharing of z/OS XL C library code by allowing its placement in Extended Link Pack Areas.

z/OS Language Environment provides facilities to set up the environment, handle termination, provide storage management, error handling, interlanguage calls and debugging support. Also, the C library functions are provided with z/OS Language Environment. In situations where not all of these services are needed or available, or more control over the executive environment is required, the system programming C facilities can provide a reduced customizable environment for your application.

System programming facilities enable you to run applications without z/OS Language Environment or with just the z/OS XL C library functions available. You can:

- Use a subset of the C language to develop specialized applications that do not require z/OS Language Environment on the machines where the application will run.

You can write freestanding applications that:

- Do not use the dynamic runtime library.
- Use only the C-specific library functions without any z/OS Language Environment facilities to manage the execution environment.

For example, a system programming application could use the C-specific library function `printf()` but not have the common run time initialize the environment. The system programming facilities would handle initialization. For more information on this type of application, see “Creating freestanding applications” on page 792.

- Use z/OS XL C as an assembler language alternative, such as for writing exit routines for MVS, TSO, or JES.

For more information on this type of application, see “Creating system exit routines” on page 798.

- Develop applications featuring a persistent C environment, where a z/OS XL C environment is created once and used repeatedly for C function execution.



For more information on this type of application, see “Creating and using persistent C environments” on page 802.

- Develop co-routines using a two-stack model, as used in client-server style applications. In this style, the user application calls upon the applications server to perform services independently of the user and then returns to the user.

For more information on this type of application, see “Developing services in the service routine environment” on page 807.

**Note:** Using the decimal data type and its related functions (`decabs()`, `decchk()`, and `decfix()`) without z/OS Language Environment is not supported.

---

## Using functions in the system programming C environment

If you do not want to use the z/OS Language Environment runtime library and the z/OS XL C runtime component within z/OS Language Environment the following functions are available in the SPC environment:

- The following library functions are available as built-in so that they can be used without the runtime library:

Function Type	Function Name
Mathematical	<code>abs()</code> , <code>fabs()</code>
Memory manipulation	<code>memchr()</code> , <code>memcmp()</code> , <code>memcpy()</code> , <code>memset()</code> , <code>cds()</code> , <code>cs()</code>
String operations	<code>strcat()</code> , <code>strchr()</code> , <code>strcmp()</code> , <code>strcpy()</code> , <code>strlen()</code> , <code>strrchr()</code>
Wide character memory manipulation	<code>wmemchr()</code> , <code>wmemcmp()</code> , <code>wmemcpy()</code> , <code>wmemset()</code>

The built-in versions of these functions are available only if the appropriate header file (`string.h`, `wchar.h`, `math.h`, or `stdlib.h`) is included in the source file. The use of these functions is described in *z/OS XL C/C++ Runtime Library Reference*.

- The memory management functions, including complete support for:
  - The `malloc()` function
  - The `calloc()` function
  - The `realloc()` function
  - The `free()` function
  - The HEAP runtime option
- The `exit()` function
- The `sprintf()` function.

**Note:** The use of floating point conversion specifiers (`e`, `E`, `f`, `g` or `G`) is not supported without the Language Environment runtime.

Additional memory management functions are available in the system programming C environment, as follows:

**`__4kmalc()`**  
to allocate page-aligned storage

**`__24malc()`**  
to allocate storage below the 16MB line in ESA systems (where MB is 1048576 bytes) even when `HEAP(ANYWHERE)` is specified.

Storage allocated by these functions is not part of the heap, so freeing it is your responsibility. You can use the `free()` function to free the storage before the environment is terminated. Storage allocated using these functions is not automatically freed when the environment is terminated.

In this environment, low-level memory management functions and contents supervision (loading and deleting executable code) are supported by low-level routines that you can replace to support non-standard environments. This is described in “Tailoring the system programming C environment” on page 823.

---

## System programming C facility considerations and restrictions

When using any system programming C environment, consider the following:

- The long long data type is not supported for the function `sprintf()` under SPC. If you need to use the long long data type, you must use the C/C++ Runtime library version of the `sprintf()` function.
- The `fetch()` function is not supported when you are running in a system programming C environment. You can use the `EDCXLOAD` routine, as described in “Loading a module” on page 826, to simulate some of the functionality of the `fetch()` function.
- The IMS parameter list established by the `#pragma runopts(PLIST(IMS))` directive is not supported in any of the system programming environments. However, this does not preclude the use of IMS within these environments, because the registers upon entry are available using the `__xregs()` function and `ctdli()` is bound statically. For more information on `__xregs()`, refer to “`__xregs()` — Get Registers on Entry” on page 833.
- Interlanguage calls to COBOL and PL/I are not supported. However, an SPC program can use the `system()` function to call modules written in other languages.
- SPC is not supported under CICS or MTF.
- Library functions for use with UNIX file system I/O are not supported under SPC. Calling them causes unpredictable results.
- All runtime options are ignored except for:
  - `STACK`
  - `HEAP`
  - `TRAP`
- Redirection of standard streams is not supported.
- The default initial stack size is the minimum size required to start the C program. (This default is different from the non-systems programming C environments.) If a size is specified, that actual value is used, provided it is large enough. If the value specified is smaller than the requirements for the program, the required value is used.
- The default value for the `HEAP` runtime option is `HEAP(12K,4K,ANY,FREE)`.
- When you are running a service routine, you should with `#pragma runopts(TRAP(OFF))`.
- Exception handling is not supported in a persistent environment.
- Invoking the `system()` function from an `atexit()` function results in undefined behavior.
- When using the `atexit()` function from a persistent environment, the `atexit` list will not be run until the persistent environment has been terminated by the `__xhott()` library function. For more information about this function, see “`__xhott()` — Terminate a Persistent C Environment” on page 832.

- Calls to math library functions can be made in a system programming C environment using the dynamic library. For the most efficient use of calls to math library functions, you should enclose the function name in parentheses (). For example, if you make a call to `sin()`, use:  

```
z = (sin)(x);
```
- You cannot call `ctrace()`, `csnap()`, `cdump()`, or `ctest()` because they rely on z/OS Language Environment callable services.
- System programming C environments are disjointed from each other; that is, memory files cannot be passed and file control is not maintained across environments. Thus, memory files cannot be passed between a C program and a callee that is written as an assembler exit.  
 An exception is between environments where the target environment is built with EDCXSTRL or EDCXSTRX but does not represent a server. For example, if a C program invokes a freestanding SPC application that is not a server by using `system()`, a memory file can be passed successfully between the programs.
- When developing an application with an interface with assembler, you can use the DSECT Conversion Utility to build structures mapping to the data types of your DSECTs.
- The POSIX locale features and coded character set conversion routines are supported only for system programming applications that use z/OS Language Environment. They are not available for freestanding applications.
- IEEE decimal floating-point data types are not supported for the function `sprintf()` under SPC. If you need to use IEEE decimal floating-point data types, you must use the C/C++ Run Time Library version of the `sprintf()` function.

---

## Creating freestanding applications

Freestanding applications are C modules that run either:

- Without z/OS Language Environment and the z/OS XL C library (using EDCXSTRT)
- Without z/OS Language Environment but with the z/OS XL C library functions (using EDCXSTRL)

Three initialization routines are provided by SPC for building freestanding applications:

### EDCXSTRT

For building completely freestanding applications. The applications can use no z/OS XL C runtime library functions and can have no z/OS Language Environment attachment.

### EDCXSTRL

For building applications that use z/OS XL C runtime library functions but have no z/OS Language Environment attachment.

### EDCXSTRX

This routine accepts a parameter to choose whether your application should behave as if it was initialized with either EDCXSTRT or EDCXSTRL. This parameter is described further in “Setting up a C environment with preallocated stack and heap” on page 794.

Certain restrictions apply to freestanding applications initialized by the routines EDCXSTRT, EDCXSTRL, and EDCXSTRX. These restrictions are as follows:

- They cannot perform interlanguage calls, except with assembler language routines that preserve register 12 and use the IBM-supplied macros for entry and exit.
- The parameters received by the `main()` function (normally `argc` and `argv`) are undefined. `__xregs()` (described in “`__xregs()` — Get Registers on Entry” on page 833) can be used to examine the parameters passed by the calling environment.
- They cannot do arithmetic using long double variables on pre-XA machines (that is, on machines that do not support the DXR instruction).

## Creating modules without CEESTART

In many environments, the initialization normally performed by z/OS Language Environment is replaced by special-purpose routines that are tailored to the specific requirements of the type of application. This requires replacing the initialization routine (CEESTART) normally used by z/OS XL C.

When you do not use the System Programming C Facilities, the compiler generates a CEESTART CSECT (control section) whenever a `main()` or *fetchable* function is encountered in the source file. With the NOSTART compiler option, described in the *z/OS XL C/C++ User's Guide*, you can suppress the generation of CEESTART for source files that contain a `main()` function where this is required. In a system programming C environment, you must compile using the NOSTART option. The object modules created will then be suitable for inclusion in applications that use the alternative initialization routines described in this section.

## Including an alternative initialization routine under z/OS

When NOSTART is used to suppress the generation of CEESTART, an alternative initialization routine must be explicitly included in the executable by the user at Link Edit. Use the Linkage Editor INCLUDE and ENTRY control statements. To include the alternative initialization routines described in this chapter, allocate CEE.SCEESPC to the SYSLIB DD. For example, you can use the linkage editor statements in Figure 173 to specify EDCXSTRT as an alternative initialization routine:

---

```
//SYSLIN DD *
INCLUDE SYSLIB(EDCXSTRT)
ENTRY EDCXSTRT
INCLUDE OBJECT(main-function)
/*
```

---

Figure 173. Specifying alternative initialization at link edit

Another example of specifying alternative initialization under z/OS is shown in Figure 175 on page 796.

## Initializing a freestanding application without Language Environment.

The EDCXSTRT routine is for C applications that do not use any z/OS Language Environment facilities or z/OS XL C facilities or library functions. It must be explicitly included in the program and specified as the program entry point if it is to be used. Under this environment, only the following library routines are supported:

- Built-in compiler functions. For a list of these functions, see “Using functions in the system programming C environment” on page 790.

- Memory management routines, including `malloc()`, `calloc()`, `realloc()`, and `free()`.
- The `exit()` and `sprintf()` functions.

**Note:** The use of floating point conversion specifiers (e, E, f, g or G) is not supported without the Language Environment runtime. Since the use of EDCXSTRT allows the application to execute without the use of the Language Environment runtime, the use of the above conversion specifiers with `sprintf()` in this environment is not supported.

- The `__4kmalc()` and `__24malc()` functions.

The value returned to the host system will be the return value from `main()`.

The RENT compiler option is supported in this environment.

## Initializing a freestanding application using C functions

The EDCXSTRL routine is the analog of CEESTART for C applications that use the z/OS XL C library functions only. EDCXSTRL supports the full library of C functions except for functions such as `cdump()`, `csnap()`, `ctest()`, or `ctrace()`. EDCXSTRL must be explicitly included in the program and specified as the program entry point if it is to be used.

The value returned to the host system will be the return value from `main()`.

The RENT compiler option is supported in this environment.

Service routines (described in “Developing services in the service routine environment” on page 807) *require* this routine (or EDCXSTRT if they do not require z/OS Language Environment) for their initialization.

Applications initialized with this routine will run in any environment supported by z/OS Language Environment.

## Setting up a C environment with preallocated stack and heap

The EDCXSTRX routine is the analog of CEESTART for an application where you want to have more control over contents supervision and storage management. Unlike EDCXSTRT, EDCXSTRL, and CEESTART, this routine cannot be entered directly from the operating system (that is, from JCL, REXX EXECs, CLISTs, or the TSO command line). It requires a structured parameter list (OS linkage) containing:

1. The parameter list to be passed to `main()`.  
`__xregs()` can be used to examine the parameters passed by the calling environment. This list cannot be accessed by `argc` or `argv`.
2. The address of the initial storage area.  
This area must be doubleword aligned with its first word containing its total length. It must be large enough to accommodate the entire stack requirements of the application.
3. The address of the complete heap allocation (or NULL if no `malloc()` family storage is required by the called routines).  
This area must be doubleword aligned with its first word containing its total length. This area *must* include sufficient space for the control structures required to manage the heap (currently a minimum of 40 bytes). Applications that use the z/OS XL C library functions will always require heap space; the

amount required depends on the structure of the application and may vary from run to run if external characteristics (file block sizes, for example) change. Any heap increments that occur because the size of the initial heap is not large enough will not be freed at termination by the system programming environment. If no initial heap allocation is specified, and a heap is required (because the z/OS XL C library functions are required, for example), it will not be freed by the System Programming C Environment. If this behavior is detected, the program will run to completion, but will abend during EDCXSTRX termination with abend code 2108 and reason code 7207.

Heap increments will be freed if you explicitly free the memory (using the `free()` function) and the runtime option `HEAP(FREE)` has been specified. You should specify a heap value of at least 4K if you are running with the z/OS XL C library functions.

4. The address of the z/OS XL C runtime library or NULL. Use CEEEV003 (or EDCZV, if you want to maintain compatibility with previous releases of OS/390 Language Environment).

The parameters (`argc` and `argv`) passed to the `main()` function are undefined. There is no argument parsing (`argc` and `argv`) or redirection of standard streams.

If the z/OS XL C library functions are required, the routine EDCXABRT must be explicitly included during the link edit. This routine enables exception handling for EDCXSTRX. If it is not explicitly included, abend code 2107 with reason code 7206 will terminate the program.

The RENT compiler option is supported in this environment only if the z/OS XL C library functions are used.

## Determining ISA requirements

The EDCXISA entry point is available to the caller of EDCXSTRX to determine the stack space overhead for the environment being created. Add stack space required by the application to the value returned by this routine to determine the size of the area to be passed as the second parameter to EDCXSTRX. If the routine is called from assembler, the value should be expected in Register 15. The routine should be declared as:

```
#pragma linkage(__xisa,0S)
```

```
int __xisa(void);
```

## Building freestanding applications to run under z/OS

When you are building freestanding applications under z/OS, CEE.SCEESPC must be included in the binder SYSLIB concatenation before CEE.SCEELKED. The routines to support this function (EDCXSTRT, EDCXSTRL, and EDCXSTRX) are CEESTART replacements (described in “Creating modules without CEESTART” on page 793) in your module. Therefore, the appropriate EDCXSTR*n* routine must be explicitly included ahead of the module at link edit. Figure 174 on page 796 shows a simple freestanding routine that requires the library.

---

```

/* this is an example of a freestanding routine */
#include <stdio.h>

int main(void) {
    puts("Hello, World");
    return 3999;
}

```

---

Figure 174. Sample Freestanding z/OS Routine

This routine is compiled normally and link edited using control statements shown in Figure 175. The CEE.SCEERUN load library must be available at run time because it contains the C library function puts().

---

```

INCLUDE SYSLIB(EDCXSTRL)
INCLUDE OBJECT
ENTRY EDCXSTRL

```

---

Figure 175. Link edit control statements used to build a freestanding z/OS routine

Figure 176 shows how to compile and link a freestanding program using the cataloged procedure EDCCL.

---

```

//JOBCL      JOBCARD STATEMENTS
//*-----
//*****
//*** COMPILE AND LINK FOR STRL ENTRY POINT
//*****
//C106001     EXEC   EDCCL,
//          INFILE='USERID.SPC.SOURCE(C106000)',
//          OUTFILE='USERID.SPC.LOAD(C106000),DISP=SHR',
//          CPARM='OPT,NOSEQ,NOMAR,NOSTART',
//          LPARM='RMODE=ANY,AMODE=31'
//COMPILE.USERLIB DD DSN=userid.HDR.FILES,DISP=SHR
//LKED.SYSLIB DD DSN=CEE.SCEESPC,DISP=SHR
//          DD DSN=CEE.SCEELKED,DISP=SHR
//LKED.SYSIN DD *
//          INCLUDE SYSLIB(EDCXSTRL)
//          ENTRY EDCXSTRL
/*

```

---

Figure 176. Compile and link using EDCCL

## Special considerations for reentrant modules

A simple freestanding routine that does not require the library is shown in Figure 177 on page 797. To develop a reentrant module, this routine must be compiled with both the RENT (because the module contains writable static at **2**) and NOSTART (because this is a system programming environment) compiler options. This routine uses the exit() function, which is normally part of the z/OS Language Environment library. Like sprintf(), it is available to freestanding routines without requiring the dynamic library.



---

```

/* this is an example of a reentrant freestanding routine */
#include <stdlib.h> 1
int main() {
    static int i[5]={0,1,2,3,4}; 2
    exit(320+i[1]);
}

```

---

Figure 177. Sample reentrant freestanding z/OS routine

Figure 178 shows the JCL required to build and execute the routine in Figure 177.

---

```

//PLKED EXEC PGM=EDCPRLK, PARM='MAP, NCAL' 1
//STEPLIB DD DSN=CEE.SCEERUN, DISP=SHR
//SYSMSG DD DSN=CEE.SCEEMSGP(EDCPMSGE), DISP=SHR
//SYSLIB DD DUMMY
//SYSMOD DD DSNNAME=&&PLKSET, SPACE=(32000, (30,30)), UNIT=SYSDA,
// DCB=(RECFM=FB, LRECL=80, BLKSIZE=3200),
// DISP=(MOD,PASS)
//SYSIN DD DSNNAME=userid.TEST.OBJECT(PROG1), DISP=SHR 2
//SYSOUT DD SYSOUT=*
//SYSPRINT DD SYSOUT=*
/*
/*
//LKED EXEC PGM=HEWL, PARM='MAP, XREF, LIST' 3
//SYSLIB DD DSNNAME=CEE.SCEESPC, DISP=SHR
// DD DSNNAME=CEE.SCEELKED, DISP=SHR
//SYSPRINT DD SYSOUT=*
//SYSLMOD DD DSNNAME=&&GOSSET(GO), SPACE=(512, (50,20,1)),
// DISP=(NEW,PASS), UNIT=SYSDA
//SYSUT1 DD SPACE=(32000, (30,30)), UNIT=SYSDA
//PRELINK DD DSNNAME=&&PLKSET, DISP=(OLD,DELETE)
//SYSLIN DD *
INCLUDE SYSLIB(EDCXSTRT) 4
INCLUDE PRELINK 5
INCLUDE SYSLIB(EDCXEXIT) 6
INCLUDE SYSLIB(EDCRCINT) 7
/*
/*
/*-----
/* Go Step
/*-----
//GO EXEC PGM=*.LKED.SYSLMOD
//SYSPRINT DD SYSOUT=*

```

---

Figure 178. Building and running a reentrant freestanding z/OS routine

- 1** The z/OS Language Environment prelinker must be used for modules compiled with the RENT compiler option.
- 2** This is the object module created by compiling the sample module with the RENT and NOSTART compiler options.
- 3** The output from the prelinker is made available to the linkage editor.
- 4** The alternative initialization routine (EDCXSTRT in this example) must be included explicitly in the module. If this is not the first CSECT in the module, it must be explicitly named as the module entry point.
- 5** The prelinked output is included in the load module.
- 6** EDCXEXIT must be explicitly included if the `exit()` function is used in the application.
- 7** The routine EDCRCINT must be explicitly included in the module if the RENT compiler option is used. No error will be detected at load time if this



routine is not explicitly included. At execution time,abend 2106, reason code 7205, will result if EDCRCINT is required but not included.

## Parts used for freestanding applications

Table 337 lists the parts used for freestanding applications and their function and location. The SYSLIB specified is CEE.SCEESPC.

Table 337. Parts used for freestanding applications

Part Name	Function	Inclusion in Program		Location
			Notes	
EDCXSTRT	Mainline for applications that do not require the z/OS Language Environment or z/OS XL C runtime library.	1	CSECT must be the module entry point.	Member of SCEESPC
EDCXSTRL	Mainline for applications that require only the C-specific library functions.	1	CSECT must be the module entry point.	Member of SCEESPC
EDCXSTRX	Mainline for applications that receive a structured parameter list that includes preallocated storage management areas.	2		Member of SCEESPC
EDCXISA	Get ISA requirements for EDCXSTRX.	2		Member of SCEESPC
EDCXSPRT	System programming version of <code>sprintf()</code> .	3		Member of SCEESPC
EDCXEXIT	System programming version of <code>exit()</code> .	3		Member of SCEESPC
EDCXMEM	System programming version of <code>malloc()</code> , <code>calloc()</code> , <code>realloc()</code> , <code>free()</code> , <code>__4kmalc()</code> and <code>__24malc()</code> .	3		Member of SCEESPC
EDCRCINT	Must be included if the compiler option <code>RENT</code> is to be used.	3		Member of SCEESPC
EDCXABRT	System programming version of exception handling.	3		Member of SCEESPC
<b>Notes:</b>				
1. This module must be explicitly included in the program using the binder <code>INCLUDE</code> control statement.				
2. This module will normally be included by automatic call.				
3. This module must be explicitly included if you want to use the system programming version of the function.				
4. Including <code>EDCXABRT</code> requires the system programmer C environment to be library enabled				

## Creating system exit routines

z/OS XL C allows the creation of routines that have no environmental requirements on entry *except*:

- Register 13 must point to a 72-byte save area
- Register 14 must contain the return address
- Register 15 must contain the entry address

There is no requirement on the name of the entry point (that is, it does not have to be `main()`), so several different entry points, with names specified by the calling environment, can be combined in the same program.

Routines that do not require the z/OS XL C environment should specify one of these two pragma forms:

- `#pragma environment(function-name)`, if the library is required, or
- `#pragma environment(function-name,nolib)`, if no library is required.

This pragma causes the compiler to generate a different prolog for the specified function. The prolog contains the instructions at the beginning of the routine that perform the housekeeping necessary for the function to run, including allocation of the function's automatic storage. This prolog will set up a C environment sufficient for both the function in which it is specified and any function that may be called. Called functions should not specify this pragma, unless they are called elsewhere without a C environment present. This new prolog will load and initialize the module containing the C library functions if this choice is specified. For more information on the `#pragma environment`, see *z/OS XL C/C++ Runtime Library Reference*.

The RENT compiler option is not supported in this environment; if you require reentrant system exit routines, the routine must be naturally reentrant. See *z/OS Language Environment Programming Guide* for more information about reentrancy.

System exit routines can be linked with their callers or dynamically loaded and invoked.

## Building system exit routines under z/OS

The CEE.SCEESPC object library must be available at link-edit time. If the C library is required by the exit routines, CEE.SCEELKED must also be made available after CEE.SCEESPC. You should explicitly name the entry point with an ENTRY statement.

## An example of a system exit

Table 338 on page 802 lists the parts used by exits. The C program (CCNGSP3) shown in Figure 179 on page 800 is a system exit that gains control from the system when an unknown CLIST subroutine is encountered. It checks if the name is recognized as a user-specific subroutine before returning control to the system. For more information on this system exit, see *z/OS TSO/E Customization*.

```

/* this is an example of a system exit */
#pragma environment(IKJCT44B,nolib) 1
/*
/* IKJCT44B CLIST EXIT
/*
*/
#include <stdio.h>
#include <stdlib.h>
#include <spc.h>
struct parmentry { int key;
                  int len;
                  char *pt; };
typedef struct parmentry P_ENT;

#define REVERSE 0
#define FLIPCHR 1
/* Valid commands */
static char *cmds[] =
{
    "SYSXTREV", "SYSXTFLIP" 2
};
void revstring( P_ENT *p11, P_ENT *p12 );
void flipstring( P_ENT *p11, P_ENT *p12 );
int IKJCT44B() {
    int **parme;
    struct parmentry *e7, *e10, *e11, *e12, *e13;

    /* Get registers on entry */
    parme = (void *)__xregs(1); 3

    /* Get the parameter entry values for those relevant for CLISTs */
    e7 = (struct parmentry *)parme[ 6]; /* exit return */
    e10 = (struct parmentry *)parme[ 9]; 4
    e11 = (struct parmentry *)parme[10];
    e12 = (struct parmentry *)parme[11];
    e13 = (struct parmentry *)parme[12];

    /* Is the command supported? */
    switch( cmdchk(e10) ) { 5
        case REVERSE: /* Reverse string */
            revstring( e11, e12 );
            break;

        case FLIPCHR: /* Exchange the first and last chars only */
            flipstring( e11, e12 );
            break;

        default: /* Unknown command type. Return with an error. */
            e12->pt[0] = 0x00;
            e12->len = 0;
            /* Set the return code */
            e7->key = 0x01;
            e7->len = 0x04;
            *(int *)&e7->pt = 0x06;
            return 12;
    }
}

```

*System exit example (Part 1 of 2)*

*Figure 179. System exit example*

```

    /* Return to caller - CLIST is supported. */
    e7->key = 0x01;
    e7->len = 0x04;
    *(int *)&e7->pt = 0x00;
    return 0;
}

/* cmdchk( P_ENT *pt )
/* - is the command in the list of user-specific cmds? */
int cmdchk( P_ENT *pt ) {
    int i;
    for( i=0; i<(sizeof(cmds)/sizeof(char *)); i++ ) {
        if( memcmp( pt->pt, cmds[i], pt->len ) == 0 )
            return i;
    }
    /* Not found */
    return -1;
}

/* revstring()....
/* - reverse the string
void revstring( P_ENT *p11, P_ENT *p12 ) {
    int i;

    for( i=0; i<p11->len; i++ )
        p12->pt[i] = p11->pt[p11->len-i-1];
    p12->len = p11->len;
}

/* flipstring() ...
/* - flip the first and last characters in the string */
void flipstring( P_ENT *p11, P_ENT *p12 ) {
    char t;
    t = p11->pt[p11->len-1];
    memcpy( p12->pt, p11->pt, p11->len );
    p12->pt[p11->len-1] = p12->pt[0];
    p12->pt[0] = t;
    p12->len = p11->len;
}

```

#### *System exit example (Part 2 of 2)*

- 1** The #pragma environment directive sets up an entry point IKJCT44B other than main().
- 2** This is the list of user-specific subroutines that are available in this system exit.
- 3** The function \_\_xregs() is used to retrieve the parameters available to the system exit in R1 from the operating system.
- 4** The parameters are parameter entries passed from TSO to this system exit and are used for the following reasons:
  - e7** Exit reason code
  - e10** Name of subroutine
  - e11** Arguments
  - e12** Result
- 5** The list of user-specific subroutines is checked and if the unknown CLIST subroutine is recognized, the subroutine is called. Otherwise, the function returns in error.

Table 338 on page 802 lists the parts used by the routines, and their function and location in MVS. The SYSLIB specified is CEE.SCEESPC.

Table 338. Parts used by exit routines

Part Name	Function	Inclusion in Program	Location
		Notes	
EDCXENV	Extended prolog code for exits that do not require the library.	2	Member of SCEESPC
EDCXENVL	Extended prolog code for exits that require the library.	2	Member of SCEESPC
EDCXSPRT	System programming version of <code>sprintf()</code> .	3	Member of SCEESPC
EDCXEXIT	System programming version of <code>exit()</code> .	3	Member of SCEESPC
EDCXMEM	System programming version of <code>malloc()</code> , <code>calloc()</code> , <code>realloc()</code> , <code>free()</code> , <code>_4kmalc()</code> and <code>_24malc()</code> .	3	Member of SCEESPC
EDCXABRT	System programming version of exception handling.	3	Member of SCEESPC
<b>Notes:</b>			
1. This module must be explicitly included in the program using the binder <code>INCLUDE</code> control statement.			
2. This module will normally be included by automatic call.			
3. This module must be explicitly included if you want to use the system programming version of the function.			

## Creating and using persistent C environments

Four routines are available to create and use a persistent C environment. These routines are used by an assembler language application that needs a C environment available to support the C functions that it calls. C main routines cannot be called in persistent C environments. The four routines are:

### EDCXHOTC

Sets up a persistent C environment (no library)

### EDCXHOTL

Sets up a persistent C environment (with library)

### EDCXHOTU

Runs a function in a persistent C environment

### EDCXHOTT

Terminates a persistent C environment

An initialization routine, `EDCXHOTC` or `EDCXHOTL` (depending upon whether the called C subroutines will need the z/OS XL C library functions), is called to create a C environment. This call returns a *handle* that can be used (through `EDCXHOTU`) to call C subroutines. The environment persists until it is explicitly terminated by calling `EDCXHOTT`.

The functions that act as entry points for these routines are `__xhotc()`, `__xhotl()`, `__xhotu()`, and `__xhott()`, respectively. For more information on these four functions, refer to Chapter 49, “Library functions for system programming C,” on page 831.

**Restrictions:**

1. C main routines are not supported in persistent C environments.
2. The RENT compiler option is not supported in the persistent environment described in this chapter.
3. Exception handling is not supported in persistent C environments.

As an alternative to the persistent environments, you can also create and retain a C environment using the preinitialized programming interface. This interface supports the RENT compiler option, but is less versatile in other respects. z/OS Language Environment provides a callable service for preinitialization called CEEPIPI. This is described in *z/OS Language Environment Programming Guide*. You may also find information in “Retaining the C environment using preinitialization” on page 258 helpful.

## Building applications that use persistent C environments

There are no special restrictions for building applications that use persistent C environments. The automatic call facility will cause the correct routines from the SYSLIB to be included.

If any C library function is required by any routine called in this environment, the stub routines library CEE.SCEELKED should be made available at link time *after* CEE.SCEESPC.

## An example of persistent C environments

The assembler routine shown in Figure 181 on page 805 illustrates the use of this feature to call a C function shown in the sample program (CCNGSP4) in Figure 180 on page 804.

---

```

/* this example uses a persistent C environment */
/* part 1 of 2-other file is CCNGSP5 */

#pragma linkage(crtn,OS) 1
#include <string.h>
#include <stdio.h>
#define INSIZE 300      /* the maximum length we'll tolerate */

void crtn(int p1,char *p2) {
    char hold[2+INSIZE];
    char *endptr;
    int i;

    endptr=memchr(p2,'@',INSIZE);
    if (NULL==endptr)
        i=INSIZE;      /* no ender? use max */
    else
        i=endptr-p2;   /* length of stuff before it */

    memcpy(hold,p2,i); /* copy formatting string */
    hold[i++]='\n';    /* add a new-line.. */
    hold[i]='\0';      /* ..and a null terminator */

    printf(hold,p1);  /* print it out */

    return;          /* and return */
}

```

---

*Figure 180. Example of function used in a persistent C environment*

This C function accepts two parameters: an integer and a printf()-style formatting string. The formatting string has a maximum length of 300 bytes; it is terminated by an @ if shorter. This routine *must* use OS linkage (**1**). The routine scans the formatting string for the terminator, copies it to a local work area, adds a trailing newline and NULL character, and prints the integer according to the formatting string.

The structure of the assembler caller (CCNGSP5) is shown in Figure 181 on page 805.

\* this example demonstrates a persistent C environment  
 \* part 2 of 2-other file is CCNGSP4

```

ENVA    CSECT
ENVA    AMODE ANY
ENVA    RMODE ANY
        STM    R14,R12,12(R13) 1
        LR     R3,R15
        USING ENVA,R3
        GETMAIN R,LV=DSALEN
        ST     R13,4(,R1)
        LR     R13,R1
        USING DSA,R13
        LA     R4,HANDLE 2
        LA     R5,STKSIZE
        LA     R6,STKLOC
        STM    R4,R6,PARMLIST
        OI     PARMLIST+8,X'80'
        LA     R1,PARMLIST
        L      R15,=V(EDCXHOTL)
        BALR   R14,R15
LOOP    LA     R8,10 3
        DS     0H
        ST     R8,LOOPCTR 4
        LA     R4,HANDLE
        LA     R5,USEFN
        LA     R6,LOOPCTR
        LA     R7,FMTSTR1
        STM    R4,R7,PARMLIST
        OI     PARMLIST+12,X'80'
        LA     R1,PARMLIST
        L      R15,=V(EDCXHOTU)
        BALR   R14,R15
        LA     R7,FMTSTR2 5
        STM    R4,R7,PARMLIST
        OI     PARMLIST+12,X'80'
        L      R15,=V(EDCXHOTU)
        BALR   R14,R15
        BCT   R8,LOOP
        ST     R4,PARMLIST 6
        OI     0(R1),X'80'
        LA     R1,PARMLIST
        L      R15,=V(EDCXHOTT)
        BALR   R14,R15
        LR     R1,R13 7
        L      R13,4(0,R13)
        FREEMAIN R,A=(1),LV=DSALEN
        LM     R14,R12,12(R13)
        SR     R15,R15
        BR     R14
  
```

*Using a persistent C environment (Part 1 of 2)*

*Figure 181. Using a persistent C environment*



```

USEFN   DC    V(CRTN)
STKSIZE DC    A(4096)
STKLOC  DC    A(1)
FMTSTR1 DC    C'1st value of loopctr is %i@'
FMTSTR2 DC    C'value on 2nd call is %i@'
        LTOrg
DSA     DSECT ,           The dynamic storage area
SAVEAREA DS    18A       The save area
PARMLIST DS    4A
HANDLE  DC    A(0)
LOOPCTR DC    A(1)
DSALEN  EQU    *-DSA
R0      EQU    0
R1      EQU    1
R2      EQU    2
R3      EQU    3
R4      EQU    4
R5      EQU    5
R6      EQU    6
R7      EQU    7
R8      EQU    8
R12     EQU    12
R13     EQU    13
R14     EQU    14
R15     EQU    15
        END    ENVA

```

*Using a persistent C environment (Part 2 of 2)*

- 1** This routine is entered with standard linkage conventions. It saves the registers in the save area pointed to by register 13, acquires a dynamic storage area for its own use, and chains the save areas together.
- 2** A C environment that includes support for the z/OS XL C library is created by calling EDCXH0TL. The parameter list for this call is the address of the handle (for the persistent C environment created), the address of a word containing the initial stack size, and the address of a word containing the initial stack location (0 for below the 16MB line and 1 for above). This parameter list uses the normal OS linkage format.
- 3** The routine loops 10 times calling the C function crtn twice each time through the loop.
- 4** The parameter list for the first call is the address of the handle, the address of a word pointing to the function, and the parameters to be received by the function. EDCXH0TU is called. This causes the specified C function, crtn() to be given control with register 1 pointing to the remaining parameters, LOOPCTR and FMTSTR1.
- 5** The C function is called again, this time with FMTSTR2 as the second parameter.
- 6** When the loop ends, EDCXH0TT is called to terminate the environment created at **2**
- 7** The routine terminates by freeing its dynamic storage area and returning to its caller.

Table 339 on page 807 lists the parts used by persistent environments and their function and location. The SYSLIB is CEE.SCEESPC.

Table 339. Parts used by persistent environments

Part Name	Function	Inclusion in Program	Location
		Notes	
EDCXHOTC	Called to set up a C environment without z/OS Language Environment.	2	Member of SCEESPC
EDCXHOTL	Called to set up a C environment with the z/OS XL C library functions available.	2	Member of SCEESPC
EDCXHOTT	Called to terminate a C environment set up by EDCXHOTC or EDCXHOTL.	2	Member of SCEESPC
EDCXHOTU	Called to use a C environment set up by EDCXHOTC or EDCXHOTL.	2	Member of SCEESPC
EDCXSPRT	System programming version of <code>sprintf()</code> .	3	Member of SCEESPC
EDCXEXIT	System programming version of <code>exit()</code> .	3	Member of SCEESPC
EDCXMEM	System programming version of <code>malloc()</code> , <code>calloc()</code> , <code>realloc()</code> , <code>free()</code> , <code>_4kmalc()</code> and <code>_24malc()</code> .	3	Member of SCEESPC
<b>Notes:</b>			
1. This module must be explicitly included in the program using the binder <code>INCLUDE</code> control statement.			
2. This module will normally be included by automatic call.			
3. This module must be explicitly included if you want to use the system programming version of the function.			

## Developing services in the service routine environment

The purpose of an application service routine environment is to allow the development, using z/OS XL C, of services that can be developed, tested, and packaged independently of their intended users. You can:

- Isolate the service code from its user
- Specify and enforce a clearly defined Application Programming Interface (API) between the user (another application program) and the service routine
- Share server code among more than one (perhaps different) user applications simultaneously
- Enhance or maintain the service routine code with no disruption to its various user applications

In this environment, a service application is developed as a C `main()` function together with any functions it may call, and packaged as a complete program. This program, if it is reentrant, can be freely installed in the ELPA and shared by all of its users.

To provide the service to a user application, the developer of the service must offer small assembler language stub routines that are link-edited with the user code. These stub routines use services provided by the System Programming Facilities to load or locate the server code and pass messages to it for execution. Examples of these stub routines are shown in “Constructing user-server stub routines” on page 822.

## Using application service routine control flow

In this section examples are based on a service routine that manages a storage queue. This server might be used by languages that do not support dynamic memory allocation, or by applications that do not want to concern themselves with the management of such data structures. The operations supported by this service routine are:

- Initialize
- Terminate
- Add an element to the head of the queue (last in, first out)
- Add an element to the tail of the queue (first in, first out)
- Get the element at the head of the queue

### Service routine user perspective

A conversation is initiated when a user routine calls a startup routine supplied by the author of the service to establish a connection between the user and the server. This routine returns a *handle* to the user that represents the server environment. User routines may establish connections with many different services or many times with the same server as long as the needed resources, principally memory, are available in the system. Each connection has a different handle, and it is the user routine's responsibility to keep track of them.

**Note:** Memory files cannot be shared between the user routines and the server.

Once the user has initialized the server, it uses other server-supplied stub routines to send requests (messages) to the server for action. One of the parameters to this routine will be the handle returned by the initialize call. These request stubs would typically return a feedback code to indicate success or failure as well as any other information requested. The server defines the parameter list to be passed and the feedback codes to be given to the user.

When the user is finished with the server, it calls yet another stub routine to terminate the server. This structure is illustrated in a sample user routine (CCNGSP6) shown in Figure 182 on page 809.

---

```

PROGRAM MAIN

C   Example User-Service Routine application

C   Define the variable that will hold the 'handle' for the server
INTEGER*4 HANDLE 1

C   Define the variable that will hold feedback codes
INTEGER*4 FEEDBACK

C   Define the variable that we'll use to get the strings back
CHARACTER*100 CH
INTEGER*4 CHLEN

C   initialize the server
CALL QMGINIT(HANDLE) 2

C   Feed some strings to the server 3
CALL QMGLIFO(HANDLE,FEEDBACK,17,'2 Sample string 1')
CALL QMGLIFO(HANDLE,FEEDBACK,23,'1 Another sample string')
CALL QMGFIFO(HANDLE,FEEDBACK,20,'3 Yet another string')

C   Get the strings back, print out length and value
DO 1 I=1,3 4
CALL QMGGET(HANDLE,FEEDBACK,CHLEN,CH)
PRINT *,CHLEN,CH(1:CHLEN) 5
1   CONTINUE

C   Terminate the server

CALL QMGTERM(HANDLE) 6

C   Go home
STOP
END

```

---

Figure 182. Example of user routine

- 1 The user routine sets up a variable that will be used to hold the handle returned by the server. The form taken by this handle is up to the supplier of the service, but a fullword (4 bytes) should be regarded as typical.
- 2 The user routine calls the initialize routine to set up the connection between the user routine and the server.
- 3 The user routine adds three strings to the queue. In this example, the first character of the string indicates the order in which the user expects to retrieve the strings.
- 4 The user enters a loop in which the strings are retrieved from the queue.
- 5 The user routine prints out the strings passed back by the call to the server. If there is no string remaining in the queue a null string (zero length) is returned.
- 6 Before ending, the user routine closes down the server.

This routine is linked normally with the server-supplied stub routines (described in “Constructing user-server stub routines” on page 822).

### Service routine perspective

A service routine is a complete, stand alone module that runs in its own C environment. Its environment is created on demand by user application routines that call it using stub routines supplied by the server. When this happens, the server code enters at its `main()` entry point and, typically, goes into a loop that contains a function call to get the next *to-do*. One possible *to-do* is *terminate*; when

this command is received the server should `exit()` or return from its `main()` function. The environment created when the server was started terminates and all resources held by the server are freed (except storage acquired by `__24malc()` or `__4kmalc()`, as described in “`__24malc()` — Allocate Storage below 16MB Line” on page 835 and “`__4kmalc()` — Allocate Page-Aligned Storage” on page 836. This structure is illustrated in a sample user routine shown in Figure 183.

```

/* this is an example of an application service routine */

#include <spc.h> 1
#include <stdlib.h>
#include <string.h>

#define LIFO 1 2
#define FIFO 2
#define GET 3
#define TERM -1

int main(void) { 3

    int retcode=0;

    /* data structures to manage the queue */
    struct queue_entry { 4
        struct queue_entry *next;
        int length;
        char val[1];
    };

    struct queue_entry *head;
    struct queue_entry *tail;

    struct { 5
        int code;
        union info *plist;
    } *req;

    union info { 6
        struct {
            int *length;
            char *string;
        } lifo;
        struct {
            int *length;
            char *string;
        } fifo;
        struct {
            int *length;
            char *string;
        } get;
    };

    /* initialize the queue pointers */
    head = NULL; 7
    tail = NULL;

```

*Example of application service routine (Part 1 of 2)*

*Figure 183. Example of application service routine*

```

/* the main processing loop goes on until a termination signal is sent */
for(;;) { 8
    union info      *info;
    int             length;
    char           *string;
    struct queue_entry *ent;

    /* get a message from the user routine */
    req=__xsrvc(retcode); 9 18
    info = req->plist; 10

    switch(req->code) { 11
        case LIFO: { 12
            length=>(*info).lifo.length;
            string= (*info).lifo.string;
            ent = malloc(sizeof *ent - 1 + length); 13
            memcpy((*ent).val,string,length);
            __xsacc(0); 14
            (*ent).length=length;
            (*ent).next=head;
            head=ent;
            if (NULL==tail) tail=ent;
            break;
        }
        case FIFO: { 15
            length=>(*info).fifo.length;
            string= (*info).fifo.string;
            ent = malloc(sizeof *ent - 1 + length);
            memcpy((*ent).val,string,length);
            __xsacc(0);
            (*ent).length=length;
            (*ent).next=NULL;
            if (NULL==head) head=ent;
            else (*tail).next=ent;
            tail=ent;
            break;
        }
        case GET: { 15
            if (NULL==head) {
                *(*info).get.length=0;
                break;
            }
            length = (*head).length;
            string = (*info).get.string;
            memcpy(string,(*head).val,length);
            *(*info).get.length=length;
            __xsacc(0);
            ent=head;
            head=(*ent).next;
            free(ent);
            if (NULL==head) tail=NULL;
            break;
        }
        case TERM: 16
            return 0;
        default:
            __xsacc(666); 17
    }
} 18
return(0);
}

```

*Example of application service routine (Part 2 of 2)*

- 1** The server routine should include the appropriate header files. `spc.h` contains the function prototypes for the routines that are used to maintain the conversation between the server routine and the user routine. `string.h` is *required* if string or memory functions are used in the code and z/OS Language Environment will not be available at run time; this header file contains the directives necessary to use these built-in functions.
- 2** These are the *command codes* of the requests that can be sent to this server.
- 3** The server begins with a `main()` function. This function gets control when the user calls `QMGINIT`.
- 4** This server manages an in-storage queue of unstructured elements. It does this by maintaining a linked list of elements. The structure `queue_entry` contains an individual entry; `head` and `tail` point to the first and last entries in the queue.
- 5** Requests come to the server in the form of a pointer to a structure containing a command code (in this case, one of `LIFO`, `FIFO`, `GET`, or `TERM`) and a pointer to a parameter list associated with the command code. The parameter list is what follows `HANDLE` and `FEEDBACK` in the calls to `QMGLIFO`, `QMGFIFO`, and `QMGGET`. Like the command codes, the structure of this parameter list is established in concert with the stub routines.
- 6** In this example, all the commands have exactly the same format. This may not generally be the case, so a union of the various parameter list formats is appropriate. Then the interface can be expanded without disrupting existing code.
- 7** Before accepting commands, required initialization is performed.
- 8** This server is structured as an endless loop. This loop terminates when a terminate message sends control to a return statement at **17**.
- 9** At this point, the server is ready for work. The call to `__xsrvc()` causes the user routine to resume execution at the place it left off when it last called the server. The value passed as the parameter is made available to the stub routines for use as a feedback code. This function will not return until the user application sends a request (using one of the stub routines, in this example `QMGLIFO`, `QMGFIFO`, `QMGGET`, or `QMGTERM`).
- 10** Extract the parameters from the structure pointed to by the call to `__xsrvc()`.
- 11** Examine the request code sent by the user application.
- 12** The `LIFO` request code is handled here.
- 13** These library functions (and many others, the complete list is given in "Using functions in the system programming C environment" on page 790) are normally available in this environment even though z/OS Language Environment is not available at run time. The amount of storage allocated is the size of the queue entry (defined at **4**) minus 1 (because the definition of the entry allowed for 1 character of value) plus the length actually required for the value.
- 14** This function should be used to indicate that the server has completed its use of any data structures (parameters and data areas pointed to by the parameters) belonging to the user application. The value passed to this function or the value passed by the next call to `__xsrvc()` (which ever is greater in magnitude) will be passed to the stub routine for use as a feedback code.

- 15** The handling of FIFO and GET is similar.
- 16** When a terminate request is received, the server returns. This terminates the loop (at **8**) and the environment set up when the server was first called.
- 17** If the command code is not recognized the server acknowledges the request and sets a return code that can be analyzed by the stub routine or the user application.
- 18** The server returns to the request for another *to-do*. The value passed as a parameter here or the last value passed to `__xsacc()`, whichever has the greater magnitude, is passed to the stub routine for use as a feedback code.

The server is built as a freestanding C application, as described in “Creating freestanding applications” on page 792.

You must specify `EDCXSTR`, `QMGSERV`, `EDCXMEM` and `EDCXEXIT` when you link edit.

## Understanding the stub perspective

The stub routines provide the link between the user application and the application service module. They are responsible for:

- Locating or loading the server code
- Providing the Application Programming Interface (API) seen by the user.

Many choices are available in the design of the API and how single calls in the user are mapped. For example, the initialize call could accept parameters governing the behavior of the session being established and pass them to the server as commands once the server has been initialized. In the example the interactions are straight forward, the initialize only starts up the server, and the message calls send single messages, untouched and unexamined, to the server.

There are two kinds of stubs: the initialization stub and the message stubs. Termination is a special case of a message stub. These stubs are most appropriately written in assembler so that they can run in any language environment with minimal performance cost.

The initialization stub is responsible for loading and calling the server. It can use the low-level storage management and contents supervision routines supplied in SCEESPC. These routines are described in “Tailoring the system programming C environment” on page 823. The structure of an initialization stub is shown in Figure 184 on page 814.



```

* this is an example of a server initialization stub
QMGINIT TITLE 'SERVER supplied stub to initialize'
QMGINIT CSECT ,
        STM R14,R12,12(R13) 1
        LR R3,R15
        USING QMGINIT,R3
        USING INPARMS,R1 2
        L R6,HANDLE@
        DROP R1
        LA R0,WALEN          length of work area, below the line 3
        L R15,=V(EDCXGET)   GETMAIN some storage
        BALR R14,R15
        USING WA,R1
        ST R13,SA+4
        LR R13,R1
        USING WA,R13        This is now our DSA
        LA R1,NAME 4
        L R15,=V(EDCXLOAD)
        BALR R14,R15        Load the server
        ST R1,PLIST 5
        MVC PLIST+4(12),PLISTINI
        L R15,=V(EDCXSRVI)
        LA R1,PLIST
        BALR R14,R15
        MVC 0(4,R15),=CL4'QMqm' eye-catcher 6
        ST R13,4(,R15) 7
        ST R15,0(,R6)    Save handle in users parameter 8
        L R13,4(,R13) 9
        LM R14,R12,12(R13)
        SR R15,R15
        BR R14
PLISTINI DS 0D
        DC A(0),V(EDCXGET,EDCXFREE)
NAME DC CL8'QMGSERV'
INPARMS DSECT
HANDLE@ DS F
WA DSECT
SA DS 18F
PLIST DS 4F
WALEN EQU *-WA
YREGS
END

```

Figure 184. Example of server initialization stub

- 1 Stub routines are presumed to have a save area available at the location pointed to by register 13.
- 2 The parameter list passed to stub routines is OS linkage; that is, register 1 points to a list of addresses. In this example, the initialization stub receives only one parameter, the handle, that gets the address of a control block representing the environment.
- 3 For efficiency, this routine gets a work area that will be used by *all* the stub routines. The low level storage management routine EDCXGET, (described in “Getting storage” on page 824) is available for this purpose. This area will be the DSA for this and all other stub routines. It begins with an 18-word save area for use by routines called by this stub. It will be freed by the “terminate” stub.
- 4 When a save area is available, EDCXLOAD (described in “Loading a module” on page 826) is called to load the server.
- 5 EDCXSRVI is called to initialize the server. When control is returned from this call, the server has built a complete environment and has asked for something to do.

- 6** The value returned by EDCXSRVI is the address of a control block that is used to manage the interface between the user application and the service application module. The first 3 words (12 bytes) of this control block are reserved for the exclusive use of the stub routines. The fields following the first 3 words may not be used by either the stub routines or the user, nor may their values be altered. In this example, an *eye-catcher* (often useful for debugging) is moved into the first word.
- 7** The address of the work area acquired for dynamic storage requirements is moved into the second word. The address of this control block is stored in the user's handle.
- 8** The address of the control block from EDCXSRVI is placed in the user routine's handle. The user routine has no knowledge of the contents or format of this field; it is simply a *token* that is passed to other stub routines to manage the conversation between the user and the service routine.
- 9** Having initialized the server, the stub returns to the user at **2** in Figure 182 on page 809.

Message stubs are responsible for passing requests from the user application to the service application. Like the initialization stub, they are free to use the low-level storage management and contents supervision routines supplied with the system programming facilities. Example message stubs are shown in Figure 185 on page 816, Figure 186 on page 817, Figure 187 on page 819, and Figure 188 on page 820.

```

* this is an example of a server message stub
QMGLIFO TITLE 'SERVER supplied stub for feeding strings LIFO'
QMGLIFO CSECT
        STM R14,R12,12(R13) 1
        LR  R3,R15
        USING QMGLIFO,R3
        LR  R5,R1
        USING INPARMS,R5
        L   R6,HANDLE@
        L   R6,0(,R6)        Point to the handle 2
        L   R1,4(,R6)       Point to work area got by QMGINIT 3
        USING WA,R1
        ST  R13,SA+4        Keep savearea passed into us
        LR  R13,R1          WA is new savearea
        USING WA,R13
        LA  R7,LIFO 4
        LA  R8,INPARMS+8    User parms start at 3rd
        STM R6,R8,PLIST     handle, LIFO, Other parms
        LA  R1,PLIST
        L   R15,=V(EDCSRVN) 5
        BALR R14,R15
        L   R1,FEEDBK@ 6
        ST  R15,0(,R1)
        L   R13,4(,R13) 7
        L   R14,12(R13)
        LM  R0,R12,20(R13)
        BR  R14
INPARMS DSECT
HANDLE@ DS F
FEEDBK@ DS F
LENGTH@ DS F
STRING@ DS F
WA      DSECT
SA      DS 18F
PLIST   DS 4F
WALEN   EQU *-WA
LIFO    EQU 1
FIFO    EQU 2
GET     EQU 3
TERM    EQU -1
YREGS
END

```

Figure 185. Example of server message stub-LIFO

- 1 Like the initialize stub, the QMGLIFO message stub expects a standard save area pointed to by register 13. The parameters are passed with standard OS linkage (register 1 pointing to a list of addresses).
- 2 The *handle* contains the value that was placed there by the initialization stub at 8 in Figure 184 on page 814. This is the address of the control block that is used to manage the interface between the user application and the server.
- 3 Recover the address of the stub work area for use as a Dynamic Storage Area (DSA). This value was saved here by the initialization stub at The save area back chain field is set according to usual conventions.
- 4 A parameter list consisting of the handle (as returned by EDCXSRVI at 5 in Figure 184 on page 814 in the initialization stub), code for LIFO, and the address of the remaining parameters.
- 5 Call EDCXSRVN to *re-awaken* the server. This causes the server to resume control at 9 in Figure 183 on page 810 in the server. The server has control until it asks for the next *to-do*, in this example at 9.
- 6 The value passed to `__xsrvc()` appears as the return code from EDCXSRVN.

This value is passed back to the user application in the second parameter. *This is part of the API defined by this particular server, not something inherent in the user-server relationship.*

**7** Control is returned to the user in the usual way.

The routine in Figure 186 uses functions supplied in SCEESPC to load or locate the server code and initialize its environment.

---

```

* this is an example of a server message stub
QMGFIFO TITLE 'SERVER supplied stub for feeding strings FIFO'
QMGFIFO CSECT
QMGFIFO AMODE ANY
QMGFIFO RMODE ANY
      STM R14,R12,12(R13) 1
      LR  R3,R15
      USING QMGFIFO,R3
      LR  R5,R1
      USING INPARMS,R5
      L   R6,HANDLE@
      L   R6,0(,R6)           Point to the handle 2
      L   R1,4(,R6)          Point to work area got by QMGINIT 3
      USING WA,R1
      ST  R13,SA+4           Keep savearea passed into us
      LR  R13,R1             WA is new savearea
      USING WA,R13
      LA  R7,FIFO 4
      LA  R8,INPARMS+8       User parms start at 3rd
      STM R6,R8,PLIST        handle, FIFO, Other parms
      LA  R1,PLIST
      L   R15,=V(EDCXSRVN) 5
      BALR R14,R15
      L   R1,FEEDBK@ 6
      ST  R15,0(,R1)
      L   R13,4(,R13) 7
      L   R14,12(R13)
      LM  R0,R12,20(R13)
      BR  R14
INPARMS DSECT
HANDLE@ DS F
FEEDBK@ DS F
LENGTH@ DS F
STRING@ DS F
WA      DSECT
SA      DS 18F
PLIST   DS 4F
WALEN   EQU *-WA
LIFO    EQU 1
FIFO    EQU 2
GET     EQU 3
TERM    EQU -1
YREGS
END

```

Figure 186. Example of server message stub-FIFO

- 1** Like the initialize stub, the QMGFIFO message stub expects a standard save area pointed to by register 13. The parameters are passed with standard OS linkage (register 1 pointing to a list of addresses).
- 2** The *handle* contains the value that was placed there by the initialization stub at **8** in Figure 184 on page 814. This is the address of the control block that is used to manage the interface between the user application and the server.
- 3** Recover the address of the stub work area for use as a Dynamic Storage

Area (DSA). This value was saved here by the initialization stub at **7** in Figure 184 on page 814. The save area back chain field is set according to usual conventions.

- 4** A parameter list consisting of the handle (as returned by EDCXSRVI at **5** in Figure 184 on page 814), code for FIFO, and the address of the remaining parameters.
- 5** Call EDCXSRVN to *re-awaken* the server. This causes the server to resume control at **9** Figure 183 on page 810 in the server. The server has control until it asks for the next *to-do*, in this example at **9** in Figure 183 on page 810, again.
- 6** The value passed to `__xsrvc()` appears as the return code from EDCXSRVN. This value is passed back to the user application in the second parameter. *This is part of the API defined by this particular server, not something inherent in the user-server relationship.*
- 7** Control is returned to the user in the usual way.

The routine in Figure 187 on page 819 uses functions supplied in SCEESPC to load or locate the server code and initialize its environment.

```

* this is an example of a server message stub
QMGGET TITLE 'SERVER supplied stub for feeding strings GET'
QMGGET CSECT
QMGGET AMODE ANY
QMGGET RMODE ANY
STM R14,R12,12(R13) 1
LR R3,R15
USING QMGGET,R3
LR R5,R1
USING INPARMS,R5
L R6,HANDLE@ 2
L R6,0(,R6) Point to the handle 2
L R1,4(,R6) Point to work area got by QMGINIT 3
USING WA,R1
ST R13,SA+4 Keep savearea passed into us
LR R13,R1 WA is new savearea
USING WA,R13
LA R7,GET 4
LA R8,INPARMS+8 User parms start at 3rd
STM R6,R8,PLIST handle, GET, Other parms
LA R1,PLIST
L R15,=V(EDCSRVN) 5
BALR R14,R15
L R1,FEEDBK@ 6
ST R15,0(,R1)
L R13,4(,R13) 7
L R14,12(R13)
LM R0,R12,20(R13)
BR R14
INPARMS DSECT
HANDLE@ DS F
FEEDBK@ DS F
LENGTH@ DS F
STRING@ DS F
WA DSECT
SA DS 18F
PLIST DS 4F
WALEN EQU *-WA
LIFO EQU 1
FIFO EQU 2
GET EQU 3
TERM EQU -1
YREGS
END

```

Figure 187. Example of server message stub-GET

- 1 Like the initialize stub, the QMGGET message stub expects a standard save area pointed to by register 13. The parameters are passed with standard OS linkage (register 1 pointing to a list of addresses).
- 2 The *handle* contains the value that was placed there by the initialization stub at 8 Figure 184 on page 814. This is the address of the control block that is used to manage the interface between the user application and the server.
- 3 Recover the address of the stub work area for use as a Dynamic Storage Area (DSA). This value was saved here by the initialization stub at 7 Figure 184 on page 814. The save area back chain field is set according to usual conventions.
- 4 A parameter list consisting of the handle (as returned by EDCXSRVI at 5 Figure 184 on page 814. in the initialization stub), code for GET, and the address of the remaining parameters.
- 5 Call EDCXSRVN to *re-awaken* the server. This causes the server to resume

control at **9** in Figure 183 on page 810 in the server. The server has control until it asks for the next *to-do*, in this example at **9** in Figure 183 on page 810, again.

- 6** The value passed to `__xsrv()` appears as the return code from `EDCXSRVN`. This value is passed back to the user application in the second parameter. *This is part of the API defined by this particular server, not something inherent in the user-server relationship.*
- 7** Control is returned to the user in the usual way.

The routine in Figure 188 uses functions supplied in `SCEESPC` to load or locate the server code and initialize its environment.

---

```

* this is an example of a server message stub
QMGTERM TITLE 'SERVER supplied stub for feeding strings TERM'
QMGTERM CSECT
QMGTERM AMODE ANY
QMGTERM RMODE ANY
STM R14,R12,12(R13) 1
LR R3,R15
USING QMGTERM,R3
LR R5,R1
USING INPARMS,R5
L R6,HANDLE@
L R6,0(,R6) Point to the handle 2
L R1,4(,R6) Point to work area got by QMGINIT 3
USING WA,R1
ST R13,SA+4 Keep savearea passed into us
LR R13,R1 WA is new savearea
USING WA,R13
ST R6,PLIST Store handle as first parameter 4
MVC PLIST+4,=A(TERM) Code for termination
LA R1,PLIST
L R15,=V(EDCXSRVN) 5
BALR R14,R15
L R13,4(,R13) 6
L R14,12(R13)
LM R0,R12,20(R13)
BR R14
INPARMS DSECT
HANDLE@ DS F
FEEDBK@ DS F
LENGTH@ DS F
STRING@ DS F
WA DSECT
SA DS 18F
PLIST DS 4F
WALEN EQU *-WA
LIFO EQU 1
FIFO EQU 2
GET EQU 3
TERM EQU -1
YREGS
END

```

---

Figure 188. Example of server message stub-TERM

- 1** Like the initialize stub, the `QMGTERM` message stub expects a standard save area pointed to by register 13. The parameters are passed with standard OS linkage (register 1 pointing to a list of addresses).
- 2** The *handle* contains the value that was placed there by the initialization stub at **8** in Figure 184 on page 814. This is the address of the control block that is used to manage the interface between the user application and the server.

- 3 Recover the address of the stub work area for use as a Dynamic Storage Area (DSA). This value was saved here by the initialization stub at 7 in Figure 184 on page 814. The save area back chain field is set according to usual conventions.
- 4 A parameter list consisting of the handle (as returned by EDCXSRVI at 5 in Figure 184 on page 814), code for TERM, and the address of the remaining parameters.
- 5 Call EDCXSRVN to *re-awaken* the server. This causes the server to resume control at 9 in Figure 183 on page 810 in the server. The server has control until it asks for the next *to-do*, in this example at 9 in Figure 183 on page 810, again.
- 6 Control is returned to the user in the usual way.

The routines in the following section are used to create and use a persistent C environment for a server co-routine, written using z/OS XL C and EDCXSTRT, or EDCXSTRL and callable by a user application written in *any* language.

An initialization routine, EDCXSRVI, is called to start up a *server*. Control returns from the initialization call with the server code started and waiting for work.

As with the persistent C environment, the initialization call returns a *handle* that is used by EDCXSRVN for further communication with the created environment. EDCXSRVN suspends the execution of the calling routine and sends a message to the waiting server. When the server completes the function called for by the message its execution is suspended and the caller of EDCXSRVN resumes.

The server environment is terminated when a *Terminate* message is sent to the server.

## Establishing a server environment

The EDCXSRVI routine creates a z/OS XL C environment for the server part of user-server application. It is intended that this routine be called by a stub routine supplied by the server and statically bound with the user application. The stub routine is responsible for loading the server application code. EDCXSRVI has the following parameters:

1. The address of the entry point of the server code. This must be the address of the EDCXSTRT or EDCXSTRL entry point.
2. The value to be in R1 when the server entry point is called. This can be used for communication between the initialization stub and the server mainline; its value can be retrieved in the server code. `__xregs(1)` will return a pointer to this list of parameters.
3. The address of a low-level get-storage routine (meeting the same interface as EDCXGET, but not necessarily EDCXGET).
4. The address of a low-level free-storage routine (meeting the same interface as EDCXFREE, but not necessarily EDCXFREE).

When this routine returns, the server environment is fully established and waiting for a message from the user. R15 points to a *handle* that is used in subsequent calls to EDCXSRVN to send messages to the server.



## Initiating a server request

The EDCXSRVN routine is used by the stub routines that are linked with user application routines to send a message to an active server in a user-server application. EDCXSRVN has the following parameters:

1. The address of the handle returned by EDCXSRVI.
2. The function code for the function to be performed. The value -1 is used to indicate that the server should terminate. This value should not be used for any other purpose.
3. Other parameters, which are passed to the server code.

Upon return, R15 will contain the return code supplied by the server (as the parameter to EDCXSACC) for this service.

## Accepting a request for service

The EDCXSACC routine operates in the server part of a user-server application. It is used to indicate acceptance or rejection of the last-requested service. EDCXSACC has the following parameter:

1. The return code of the last-requested service 0 indicating that the request was accepted and will be processed.

For more information on EDCXSACC, see “`__xsacc()` — Accept Request for Service” on page 834.

## Returning control from service

The EDCXSRVC routine operates in the server part of a user-server application. It is used to indicate completion of the last-requested service and to get information required for the next service to be performed. For more information on EDCXSRVC, see “`__xsrvc()` — Return Control from Service” on page 835. EDCXSRVC has the following parameter:

1. The return code for the last-requested service.

## Constructing user-server stub routines

Part of building a server for use in a user-server environment is the construction of stub routines that load and initialize the server, pass messages to the server, and terminate the server. These stub routines are typically written in assembler language to allow them to be freely called from other environments without regard to the characteristics of the calling environment.

## Building user-server environments

To build your server application, follow the rules for building a freestanding application as described in “Building freestanding applications to run under z/OS” on page 795.

There are no special considerations for building user applications. The automatic call facility will cause the correct routines from CEE.SCEESPC to be included.

Table 340. Parts used by or with application server routines

Part Name	Function	Inclusion in Program		Location
		Notes		
EDCXSRVI	Used by a server-supplied stub routine to start up a server.	2	in the user module	Member of SCEESPC
EDCXSRVN	Used by a server-supplied stub routine to send a service-request message to a server.	2	in the user module	Member of SCEESPC
EDCXSRVC	Used by a server to wait for the next message to process.	2	in the user module	Member of SCEESPC
EDCXSAACC	Used by a server to accept the last message received.	2	in the user module	Member of SCEESPC
EDCXSPRT	System programming version of <code>sprintf()</code> .	3		Member of SCEESPC
EDCXEXIT	System programming version of <code>exit()</code> .	3		Member of SCEESPC
EDCXMEM	System programming version of <code>malloc()</code> , <code>calloc()</code> , <code>realloc()</code> , <code>free()</code> , <code>_4kmalc()</code> and <code>_24malc()</code> .	3		Member of SCEESPC
<b>Notes:</b>				
1. This module must be explicitly included in the program using the binder <code>INCLUDE</code> control statement.				
2. This module will normally be included by automatic call.				
3. This module must be explicitly included if you want to use the system programming version of the function.				

## Tailoring the system programming C environment

Depending on the environment under which you want to run your z/OS XL C routines, you might want to replace some of the following routines for system-specific routines. To work correctly, your routines should match the interface as documented in this section. The routines as supplied by IBM with z/OS XL C meet the interface as documented.

### Generating abends

The `EDCXABND` routine is called to generate an abend if there is an internal error during initialization or termination of a system programming C environment. This module must have the entry point name of `@@XABND`. It uses the following parameter:

**R1** The address of the abend code and reason code

This routine is *not* provided with a save area. In addition to the linkage registers, this routine may freely alter registers 2 and 4. Figure 189 on page 824 shows an example.

---

```

* this is an example of a routine to generate an abend
@@XABEND TITLE 'Generate an Abend'
EDCXABND CSECT
EDCXABND AMODE ANY
EDCXABND RMODE ANY
@@XABND DS 0H
        ENTRY @@XABND
        BALR R2,0
        USING *,R2
        SPACE 1

*
        USING PARMs,R1
        L    R4,REAS_RC      get reason code
        L    R2,ERROR_RC     get error code
        DROP R1,R2
ABEND   ABEND (R2),REASON=(R4)
*
        LTORG
        EJECT
PARMS   DSECT
ERROR_RC DS F
REAS_RC DS F
*
R1      EQU 1
R2      EQU 2
R3      EQU 3
R4      EQU 4
        END

```

---

Figure 189. Example of routine to generate abend

## Getting storage

The EDCXGET routine is called to get storage from the operating system. The entry point name for this routine must be @@XGET; see Figure 190 on page 825 for an example. It uses the following parameter:

**R0** The requested length, in bytes. If the high-order bit is zero or if the request was made in 24-bit addressing mode, the storage will be allocated below the 16M line. If the high-order bit is on and the request is made in 31-bit addressing mode, storage will be allocated anywhere with a preference for storage above the 16M line if available.

Upon return, the following values are set:

**R0** The length of the storage block acquired, in bytes.

**R1** The address of the acquired area or NULL.

**R15** A system dependent return code, which must be zero on success and non-zero otherwise.

This routine is *not* provided with a save area. In addition to the linkage registers, this routine may freely alter registers 2 and 4.

If you provide your own EDCXGET routine, it will be used when C library functions explicitly get storage. Whenever the library functions invoke operating system services, there may be implicit requests for storage that cannot be tailored.

---

```

* this is an example of a routine to get storage
@@XGET  TITLE  'Obtain memory as specified in R0'
EDCXGET CSECT
EDCXGET AMODE ANY
EDCXGET RMODE ANY
@@XGET  DS    0H
        ENTRY @@XGET
        SPACE 1
        BALR  R2,R0
        USING *,R2
        LTR   R0,R0           Memory above or below?
        BNL  BELOW
        SLL  R0,1           Want memory anywhere
        SRL  R0,1
        LTR  R2,R2           are we running above the line?
        BNL  BELOW         no, so ignore above request
        GETMAIN RC,SP=0,LV=(R0),LOC=ANY
        LTR  R15,R15        Was it successful?
        BZR  R14            Yes...
        SR   R1,R1         No, indicate failure
        BR   R14
BELOW   DS    0H           Get memory below the line
        GETMAIN RC,SP=0,LV=(R0),LOC=BELOW
        LTR  R15,R15        Was it successful?
        BZR  R14            Yes...
        SR   R1,R1         no, indicate failure in R1
        BR   R14
*
R0      EQU   0
R1      EQU   1
R2      EQU   2
R4      EQU   4
R13     EQU   13
R14     EQU   14
R15     EQU   15

```

---

Figure 190. Example of routine to get storage

## Getting page-aligned storage

The EDCX4KGT routine is called to get page-aligned storage from the operating system. Its entry point must be @@X4KGET. It has the following parameter:

**R0** The requested length, in bytes. If the high-order bit of this register is zero or if the request was made in 24-bit addressing mode, the storage is allocated below the 16M line. If the high-order bit is on and the request is made in 31-bit addressing mode, storage is allocated above the 16M line. If this space is not available, storage is allocated elsewhere.

Upon return, the following values are set:

**R0** The length of the storage block acquired, in bytes. This length may be greater than the size requested.

**R1** The address of the acquired area or NULL.

**R15** A system-dependent return code, which must be zero on success and nonzero otherwise.

This routine is *not* provided with a save area. In addition to the linkage registers, this routine may freely alter registers 2 and 4.

## Freeing storage

The EDCXFREE routine is called to return storage to the operating system. Its entry point must be @@XFREE. It uses the following parameters:

- R0 The length of storage to be freed, in bytes
- R1 The address of the area to be freed

Upon return, the following value is set.

- R15 A system-dependent return code, which must be zero on success and nonzero otherwise

This routine is *not* provided with a save area. In addition to the linkage registers, this routine may freely alter registers 2 and 4.

If you provide your own EDCXFREE routine, it will be used when C library functions explicitly free storage. Whenever the library functions invoke operating-system services, there may be implicit requests to free storage that cannot be tailored.

Figure 191 shows an example of a routine that is used to free storage.

---

```
* this is an example of a routine to free storage
EDCXFREE CSECT
EDCXFREE AMODE ANY
EDCXFREE RMODE ANY
@@XFREE DS 0H
        ENTRY @@XFREE
        BALR R2,0
        USING *,R2
*
        FREEMAIN RC,SP=0,LV=(0),A=(1)
        BR R14 return
*
R2 EQU 2
R14 EQU 14
END
```

---

Figure 191. Example of routine to free storage

## Loading a module

The EDCXLOAD routine is called to load a named module into storage. Its entry point must be @@XLOAD. It has the following parameter:

- R1 Points to the name of the routine to be loaded

On return, the following values are set.

- R1 the address and amode of the routine or 0
- R15 A system-dependent return code, which must be zero on success and nonzero otherwise

This routine *is* provided with a save area. Apart from the linkage registers, it must save and restore all registers used.

## Deleting a module

The EDCXUNLD routine is called to delete a named module from storage. Its entry point must be @@XUNLD. It has the following parameter:

**R1** Points to the name of the routine to be deleted

Upon return, the following values is set.

**R15** A system-dependent return code, which must be zero on success and nonzero otherwise

This routine *is* provided with a save area. Apart from the linkage registers, it must save and restore all registers used.

---

## Including a runtime message file

When you are running a freestanding environment and runtime messages are required, you must explicitly include a message file at link-edit time. One of the three following modules can be included to produce these messages:

**EDCXLANE**

Creates runtime error messages in uppercase and lowercase English

**EDCXLANU**

Creates runtime error messages in uppercase English

**EDCXLANK**

Creates runtime error messages in Kanji

If one of these message routines is not included and an exception occurs, the program could terminate without displaying a message. These error messages are directed to `stderr`. Refer to *z/OS Language Environment Debugging Guide* for more information.

Table 341 contains the abend codes and reason codes specific to the system programming facilities.

*Table 341. Abend and reason codes specific to system programming environments*

Code Type	Code	Description
Abend	2100	No storage abend code
	2101	Error freeing storage
	2102	Error finding stack seg home
	2103	Error loading library
	2104	Error with heap allocation
	2105	Error with system level command
	2106	Error initializing statics
	2107	Error establishing error handler for EDCXSTRX
	2108	Error cleaning up heap for EDCXSTRX
	4000	Error when handling abend

Table 341. Abend and reason codes specific to system programming environments (continued)

Code Type	Code	Description
Reason	7201	Error in initialization.
	7202	Error in termination.
	7203	Error when extending stack.
	7204	Error during longjmp/setjmp.
	7205	Can not locate static init. The routine EDCRCINT must be included in your module if you use the RENT compiler option.
	7206	Module EDCXABRT was not explicitly included at link edit time.
	7207	No initial heap allocation is specified and a heap is required.

## Additional library routines

The following routines provide additional support that is unique to applications running in a system programming C environment. These routines are packaged as part of the link library. For more information on these routines refer to Chapter 49, "Library functions for system programming C," on page 831.

- \_\_xregs()**  
Get registers on entry
- \_\_xusr()**  
Get address of User Word
- \_\_xusr2()**  
Get address of User Word
- \_\_4kmalc()**  
Allocate page-aligned storage
- \_\_24malc()**  
Allocate storage below 16mb line

## Summary of application types

Table 342 shows the summary of application types, how they are called, and the module entry points.

Table 342. Summary of types

Type of Application	How It Is Called	Module Entry Point	Data Sets Required at Execution Time	Runtime Options (1) and Other Considerations
A mainline function that requires no dynamic library facilities	From the command line, JCL, or an EXEC or CLIST.	EDCXSTRT, which must be explicitly included at bind time	None.	Runtime options are specified by #pragma runopts in compilation unit for the main() function. The heap and stack options are honored. The stack defaults to be above the line.

Table 342. Summary of types (continued)

Type of Application	How It Is Called	Module Entry Point	Data Sets Required at Execution Time	Runtime Options (1) and Other Considerations
A mainline function that requires the z/OS XL C library functions	From the command line, JCL, or an EXEC or CLIST.	EDCXSTRL, which must be explicitly included at bind time	CEE.SCEERUN is required	Runtime options are specified by #pragma runopts in the compile unit for the entry point. The heap and stack options are honored, except that the stack will default to be above the line. The SPIE option is honored if a library is called for.
A C subroutine called from assembler language using a pre-established persistent environment	A <i>handle</i> , the address of the subroutine and a parameter list are passed to EDCXHOTU.		CEE.SCEERUN is optional, depending upon the way the <i>handle</i> was set up.	Runtime options are specified by #pragma runopts in any compile unit. The heap and stack options are honored, except that the stack will default to be above the line. The SPIE option is honored if a library is called for. The runopts in the first object module in the link edit that contains runopts will prevail, even if this compilation unit is part of the calling application.  The environment is established by calling EDCXHOTC (or EDCXHOTL if library facilities are required). These functions return a value (the <i>handle</i> ) which is used to call functions that use the environment.
A Server	User code includes a stub routine that calls EDCXSRVI. This causes the server to be loaded and control to be passed to its entry point.	EDCXSTRT, or EDCXSTRL, depending upon whether the server needs the C runtime library or not	CEE.SCEERUN if required by the server code.	Runtime options are the same as for EDCXSTRL or EDCXSTRT.  The author of the server must supply stub routines which call EDCXSRVI and EDCXSRVN to initialize and communicate with the server. These are bound with the user application.
A User of an Application Server			The server and CEE.SCEERUN if required by the server.	The author of the server must supply stub routines which call EDCXSRVI and EDCXSRVN to initialize and communicate with the server.





---

## Chapter 49. Library functions for system programming C

This chapter describes the library functions specific to the System Programming C environment:

- `__xhotc()`
- `__xhotl()`
- `__xhott()`
- `__xhotu()`
- `__xregs()`
- `__xsacc()`
- `__xsrvc()`
- `__xusr()`
- `__xusr2()`
- `__24malc()`
- `__4kmalc()`

---

### `__xhotc()` — Set Up a Persistent C Environment (No Library)

#### Purpose

The function creates a persistent C environment that does not require the dynamic library facilities of z/OS Language Environment at run time.

For an extensive example of the use of `__xhotc()`, see “Creating and using persistent C environments” on page 802.

#### Format

```
#include <spc.h>

void *__xhotc(void *handle, int stack, int location);
```

The parameters are fullwords (four bytes).

*handle*

the field for the token (or handle) which is returned

*stack*

initial stack allocation required for the environment

*location*

location of the stack:

0 Below the line

1 Above the line

#### Returned value

`__xhotc()` returns a token (or handle) which is used in subsequent calls to `__xhotu()` and `__xhott()` to use or terminate a persistent C environment. This handle is found in both the first parameter passed and R15.

The RENT compiler option is not supported for routines called using this environment.

---

## **\_\_xhotl() — Set Up a Persistent C Environment (With Library)**

### **Purpose**

The function creates a persistent C environment that will use the dynamic z/OS XL C/C++ library functions. All library facilities are available in this environment except:

- The RENT compiler option is not supported in the persistent environment described in this chapter.
- Exception handling is not supported in persistent C environments.

For an extensive example of the use of `__xhotl()`, see “Creating and using persistent C environments” on page 802.

### **Format**

```
#include <spc.h>
void *__xhotl(void *handle, int stack, int location);
```

The following parameters are fullwords (four bytes):

*handle*

the field for the token (or handle) which is returned

*stack*

the initial stack allocation required for the environment

*location*

location of the stack:

0 Below the line

1 Anywhere

### **Returned value**

This routine returns a token (or handle) which is used in subsequent calls to `__xhotu()` and `__xhott()` to use or terminate a persistent C environment. This handle is found in both the first parameter passed and R15.

---

## **\_\_xhott() — Terminate a Persistent C Environment**

### **Purpose**

This function terminates a persistent C environment created by `__xhotc()` or `__xhotl()`. `__xhott()` is specific to SP C. It is part of the group serving the persistent C environment. (The function is also available under the name EDCXHOTT.)

For an extensive example of the use of `__xhott()`, see “Creating and using persistent C environments” on page 802.

## Format

```
#include <spc.h>

void __xhott(void *handle);
```

The parameter of `__xhott()` is a handle returned by `__xhotc()` or `__xhotl()`.

---

## `__xhotu()`

### Purpose

This function is used to run a function in a persistent C environment. The function is also available under the name `EDCXHOTU`.

This routine, and the C function being called, must use OS linkage. As a result, you cannot make direct use of z/OS XL C/C++ Library functions with this function. C functions being invoked using `__xhotu()` must be compiled with `#pragma linkage(func_name,OS)`.

`__xhotu()` is specific to SP C. It is part of the group serving the persistent C environment.

For an extensive example of the use of `__xhotu()`, see “Creating and using persistent C environments” on page 802.

### Format

```
#include <spc.h>

void *__xhotu(void *handle, void *function, ...);
```

The parameters are fullwords (four bytes):

*handle*

a handle—returned by `__xhotc()` or `__xhotl()`

*function*

a function pointer, which points to the desired C function

- First parameter to pass to the function
- Second parameter to pass to the function

### Returned value

The returned value from `__xhotu()` is the returned value from the function run in the persistent C environment.

---

## `__xregs()` — Get Registers on Entry

### Purpose

This routine finds the value a specified register had on entry to `EDCXSTRT`, `EDCXSTRL`, `EDCXSTRX`, or the *main* routine of an exit routine compiled with `#pragma environment(...)`.

`__xregs()` is available in these environments only. For more information about `EDCXSTRT`, `EDXSTRL`, or `EDCXSTRX`, see “Creating freestanding applications” on page 792.

`__xregs()` is specific to SP C. It is part of the client-server group of functions.

The function is also available under the name `EDCXREGS`.

### Format

```
#include <spc.h>
int __xregs(int register);
```

### Returned value

`__xregs()` returns the value found.

---

## `__xsacc()` — Accept Request for Service

### Purpose

This routine operates in the server part of a user-server application. It is used to indicate acceptance or rejection of the last-requested service. The function is also available under the name `EDCXSAACC`.

Calls to `__xsacc` are optional but, if made, should be when the request is validated and all server references to user-owned storage are complete. `__xsacc` does not cause a return of control to the user; its sole purpose is to indicate that user-owned storage is no longer required by the application server.

In the case of a request that cannot be processed, possibly because the user's command is not recognized by the server or the parameter format is invalid, the call to `__xsacc` should be omitted.

`__xsacc()` is specific to SP C. It is part of the client-server group of functions.

### Format

```
#include <spc.h>
void __xsacc( int message );
```

### Returned value

The return code for the last-requested service, zero indicating that the request was accepted and will be processed.

---

## **\_\_xsrvc() — Return Control from Service**

### **Purpose**

This routine operates in the server part of a user-server application. It is used to indicate completion of the last-requested service and to get the information required for the next service to be performed. The function is also available under the name EDCXSRVC.

`__xsrvc()` is specific to SP C. It is part of the client-server group of functions.

### **Format**

```
#include <spc.h>

void *__xsrvc(int message);
```

The *message* is the return code for the last-requested service.

---

## **\_\_xusr() - \_\_xusr2() — Get Address of User Word**

### **Purpose**

The `__xusr()` and `__xusr2()` functions are also available under the names EDCXUSR and EDCXUSR2, respectively. Two words in an internal control block are available for customer use. These words have an initial value of zero (that is, all bits are 0), but are otherwise ignored by compiled code, and by the z/OS XL C/C++-specific Library. The values in these words may be freely queried or set by application code using the pointers returned by these functions.

`__xusr()` and `__xusr2()` are specific to SP C.

### **Format**

```
#include <spc.h>

void *__xusr(void);
void *__xusr2(void);
```

### **Returned value**

`__xusr()` and `__xusr2()` return the addresses of these user words. The words, and `__xusr()` and `__xusr2()` themselves, are available in *any* environment, not only the system programming environments.

---

## **\_\_24malc() — Allocate Storage below 16MB Line**

### **Purpose**

This function performs in the same manner as `malloc` except that it allocates storage below the 16MB line in XA or ESA systems, even when the runtime option `HEAP(ANYWHERE)` is specified. Storage allocated by this function is not part of the heap, so you must free this storage explicitly using the `free()` function before this

environment is terminated. Storage allocated using `__24malloc()` is not automatically freed when the environment is terminated.

The function is available under the System Programming Environment.

### Format

```
#include <spc.h>

void *__24malloc(size_t size);
```

---

## `__4kmalc()` — Allocate Page-Aligned Storage

### Purpose

This function performs in the same manner as `malloc()`, except that it allocates page-aligned storage. Storage allocated by this function is not part of the heap, so you must free this storage explicitly using the `free()` function before this environment is terminated. Storage allocated using `__4kmalc()` is not automatically freed when the environment is terminated.

The function is available under the System Programming Environment.

### Format

```
#include <spc.h>

void *__4kmalc(size_t size);
```

---

## Chapter 50. Using runtime user exits

This chapter shows how to use runtime user exits with the z/OS Language Environment runtime library. This is general-use programming interface information and associated guidance information for using the library.

This section is provided here for your convenience. For further information on using runtime user exits in the z/OS Language Environment environment, refer to *z/OS Language Environment Programming Guide*.

**Note:** Runtime user exits are not supported in AMODE 64 applications.

---

### Using runtime user exits in z/OS Language Environment

z/OS Language Environment provides user exits that you can use for functions at your installation. You can use the assembler user exit (CEEEXITA) or the HLL user exit (CEEBINT). This section provides information about using these runtime user exits.

**Note:** You cannot code either the CEEEXITA user exit or the CEEBINT user exit as an XPLINK application.

#### Understanding the basics

User exits are invoked under z/OS Language Environment to perform enclave initialization functions and both normal and abnormal termination functions. User exits offer you a chance to perform certain functions at a point where you would not otherwise have a chance to do so. In an assembler initialization user exit, for example, you can specify a list of runtime options that establish characteristics of the environment. This is done before the actual execution of any of your application code. Another example is using an assembler termination user exit to request a dump after your application has terminated with an abend.

In most cases, you do not need to modify any user exit to run your application. Instead, you can accept the IBM-supplied default versions of the exits, or the defaults as defined by your installation. To do so, run your application normally and the default versions of the exits are invoked. You may also want to read the sections “User exits supported under z/OS Language Environment” on page 838 and “Order of processing of user exits” on page 838, which provide an overview of the user exits and describe when they are invoked.

If you plan to modify either of the user exits to perform some specific function, you must link the modified exit to your application before running, as described in “Using installation-wide or application-specific user exits” on page 839. In addition, the sections “Using the Assembler user exit” on page 840 and “High level language user exit interface” on page 852 describe the respective user exit interfaces to which you must adhere to change an assembler or HLL user exit.

#### PL/I and C/370 compatibility

For more information on compatibility support for the IBMBXITA and IBMFXITA assembler user exits, see “PL/I and C/370 compatibility” on page 851. Refer to



IBM C/370 Library Version 2 Release 2 Programming Guide or to PL/I for MVS & VM Compiler and Run-Time Migration Guide for information about the IBMBINT HLL user exit. IBMBINT is not available under C++.

## User exits supported under z/OS Language Environment

z/OS Language Environment provides two user exit routines, one written in assembler and the other in an HLL. You can find sample jobs containing these user exits in the SCEESAMP sample library. The user exits supported by z/OS Language Environment are shown in Table 343.

Table 343. User exits supported under z/OS Language Environment

Name	Type of User Exit	When Invoked
CEEBXITA	Assembler user exit	Enclave initialization Enclave termination Process termination
CEEBINT	HLL user exit. CEEBINT can be written in z/OS XL C, PL/I, z/OS Language Environment-conforming assembler, or in C++ (see restrictions in "Order of processing of user exits").	Enclave initialization

## Order of processing of user exits

The location and order in which user exits are driven for your application are summarized in Figure 192.

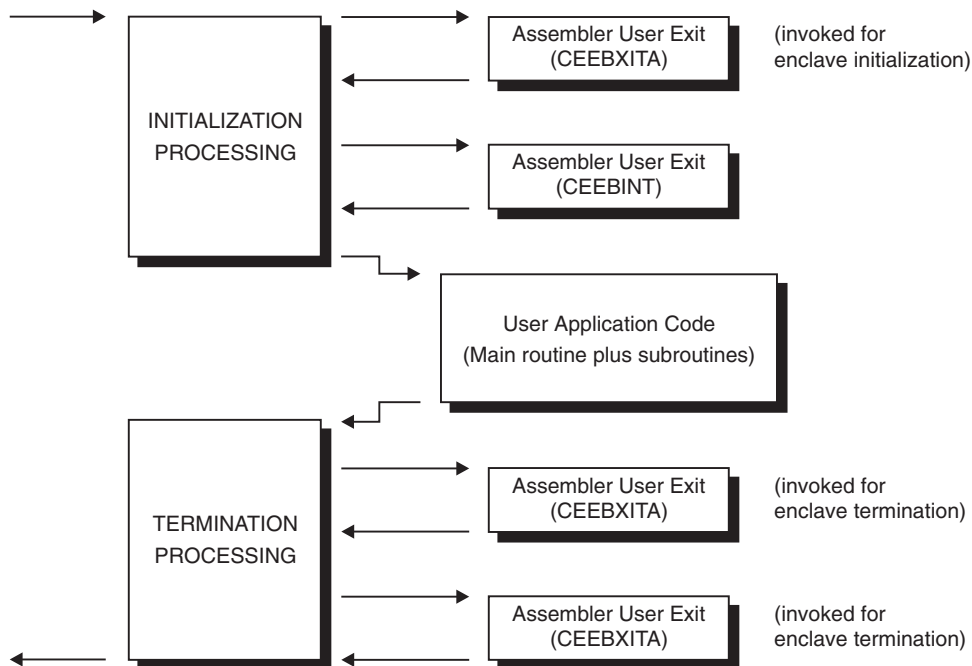

Figure 192. Location of user exits

In Figure 192, runtime user exits are invoked in the following sequence:

1. Assembler user exit is invoked for enclave initialization.

The assembler user exit (CEEBXITA) is invoked very early during the initialization process, before the enclave initialization is complete. Early invocation of the assembler exit allows the enclave initialization code to benefit from any changes that might be contained in the exit. If runtime options are provided in the assembler exit, the enclave initialization code is aware of the new options.

2. Environment is established.
3. HLL user exit is invoked.

The HLL initialization exit (CEEBINT) is invoked just before the invocation of the application code. In z/OS Language Environment, this exit can be written in z/OS XL C, PL/I, z/OS Language Environment-conforming assembler, or z/OS XL C++. However, you can only write CEEBINT in z/OS XL C++ if the following conditions are met:

- CEEBINT must be declared with C linkage. That is, it must be declared with `extern "C"`. If you are using C, you must compile your application code with the RENT compile-time option.
- You must bind your application code with the z/OS binder.
- CEEBINT must be used as an application-specific user exit, rather than as an installation-wide user exit (See “Using installation-wide or application-specific user exits” for more information).
- The following information must be coded so that SMP/E can maintain the CSECT and properly link the intended user exit:

```
#pragma map(CEEBINT,"CEEBINT")
```

The HLL initialization exit *cannot* be written in COBOL, although COBOL applications can use this HLL user exit. At the time when CEEBINT is invoked, the runtime environment is fully operational and all z/OS Language Environment-conforming HLLs are supported.

4. Main routine is invoked.
5. Main routine returns control to caller.
6. Environment is terminated.
7. Assembler user exit is invoked for termination of the enclave.  
CEEBXITA is invoked for enclave termination processing after all application code in the enclave has completed, but before any enclave termination activity.
8. Assembler user exit is invoked for termination of the process.  
CEEBXITA is invoked again when the z/OS Language Environment process terminates.

Although both the assembler and HLL exits are invoked for initialization, they do not perform exactly the same functions. See “CEEBXITA behavior during enclave initialization” on page 840 and “High level language user exit interface” on page 852 for a detailed description of each exit.

z/OS Language Environment provides the CEEBXITA assembler user exit for termination but does not provide a corresponding HLL termination user exit.

## Using installation-wide or application-specific user exits

IBM offers default versions of CEEBXITA and CEEBINT. You can use the IBM-supplied default version of either exit, or you can customize CEEBXITA or CEEBINT for use on an installation-wide basis. When CEEBXITA or CEEBINT is linked with the z/OS Language Environment initialization/termination library routines during installation, it functions as an installation-wide user exit.

Finally, you can customize CEEBXITA or CEEBINT yourself for use on your application. When CEEBXITA or CEEBINT is linked in your program, it functions as an application-specific user exit. The application-specific exit is used only when you run that application. The installation-wide assembler user exit is not executed.

To obtain an application-specific user exit, you must explicitly include it at bind time in the application using a binder INCLUDE control statement. Any time that the application-specific exit is modified, it must be relinked with the application.

The assembler user exit interface is described in “Assembler user exit interface” on page 842. The HLL user exit interface is described in “High level language user exit interface” on page 852.

## Using the Assembler user exit

The assembler user exit CEEBXITA tailors the characteristics of the enclave before it is established. CEEBXITA must be written in assembler language because an HLL environment may not yet be established when the exit is invoked. CEEBXITA is driven for enclave initialization and enclave termination regardless of whether the enclave is the first enclave in the process or a nested enclave. CEEBXITA can differentiate easily between first and nested enclaves. For more information about nested enclaves, see *z/OS Language Environment Programming Guide*.

CEEBXITA behaves differently depending on when it is invoked, as described in the following sections.

## Using sample Assembler user exits

Sample assembler user exit programs are distributed with z/OS Language Environment. You can use them and modify the code for the requirements of your own application. Choose a sample program appropriate for your application. Table 344 lists the assembler exit user programs that are delivered with z/OS Language Environment.

*Table 344. Sample Assembler user exits for z/OS Language Environment*

Example User Exit	Operating System	Language (if Language Specific)
CEEBXITA	MVS (default)	
CEEBXITC	TSO	
CEECXITA	CICS (default)	
CEEBX05A	MVS	COBOL

### Notes:

1. CEEBXITA and CEECXITA are the defaults on your system for MVS and CICS, if z/OS Language Environment is installed at your site without modification.
2. The source code for CEEBXITA, CEEBXITC, CEEDXITA, and CEEBX05A can be found on MVS in the sample library SCEESAMP.
3. CEEBX05A is an example user exit program for COBOL applications on z/OS.

## CEEBXITA behavior during enclave initialization

The CEEBXITA assembler user exit is invoked before enclave initialization is performed. You can use it to help guide the establishment of the environment in which your application runs. For example, you can allocate data sets in the assembler user exit. The user exit can interrogate program parameters supplied in the JCL and change them if desired. In addition, you can specify runtime options

in the user exit using the CEEAUE\_OPTIONS field of the assembler interface (see “Assembler user exit interface” on page 842 for information about how to do this).

CEEBXITA performs no special tasks other than to return control to z/OS Language Environment initialization.

### **CEEBXITA behavior during enclave termination**

The CEEBXITA assembler exit is invoked after the user code for the enclave has completed, but before the occurrence of any enclave termination activity. For example, CEEBXITA is invoked before the storage report is produced (if one was requested), before data sets are closed, and before HLLs are invoked for enclave termination. In other words, the assembler user exit for termination is invoked when the environment is still active.

The assembler user exits allow you to request an abend. Under z/OS (as well as TSO and CICS), you can also request a dump to assist in problem diagnosis. Note that termination activities have not yet begun when the user exit is invoked. Thus, the majority of storage has not been modified when the dump is produced.

It is possible to request an abend and dump in the enclave termination user exit for all enclave-terminating events.

Example code that shows how to request an abend and dump when there is an unhandled condition of severity 2 or greater can be found in the member CEEBX05A in the sample library.

### **CEEBXITA behavior during process termination**

The CEEBXITA assembler exit is invoked after:

- All enclaves have terminated.
- The enclave resources have been relinquished.
- Any z/OS Language Environment-managed files have been closed.
- Debug Tool has terminated.

This allows you to free files at this time, and it presents another opportunity to request an abend.

During termination, CEEBXITA can interrogate the z/OS Language Environment reason and return codes and, if necessary, request an abend with or without a dump. This can be done at either enclave or process termination.

The IBM-supplied CEEBXITA performs no special tasks other than to return control to z/OS Language Environment termination.

### **Specifying abend codes to be percolated by z/OS Language Environment**

The assembler user exit, when invoked for initialization, can return a list of abend codes that are to be percolated by z/OS Language Environment. On non-CICS systems, this list is contained in the CEEAUE\_A\_AB\_CODES field of the assembler user exit interface. (See “Assembler user exit interface” on page 842.) Both system abends and user abends can be specified in this list.

When TRAP(ON) is in effect, and the abend code is in the CEEAUE\_A\_AB\_CODES list, z/OS Language Environment percolates the abend. Normal z/OS Language Environment condition handling is never invoked to handle these abends. This

feature is useful when you do not want z/OS Language Environment condition handling to intervene for some abends, for example, when IMS issues abend code 777.

When TRAP(OFF) is specified, the condition handler is not invoked for any abends or program interrupts. The use of TRAP(OFF) is not recommended; refer to *z/OS Language Environment Programming Reference* for more information.

### **Actions taken for errors that occur within the Assembler user exit**

If any errors occur during the enclave initialization user exit, the standard system action occurs because z/OS Language Environment condition handling has not yet been established.

Any errors occurring during the enclave termination user exit lead to abnormal termination (through an abend) of the z/OS Language Environment environment.

If a program check occurs during the enclave termination user exit and TRAP(ON) is in effect, the application ends abnormally with ABEND code 4044 and reason code 2. If a program check occurs during the enclave termination exit and "TRAP(OFF)" has been specified, the application ends abnormally without additional error checking support. z/OS Language Environment provides no condition handling; error handling is performed by the operating system. The use of TRAP(OFF) is not recommended; refer to *z/OS Language Environment Programming Guide* for more information.

z/OS Language Environment takes the same actions as described above for program checks during the process termination user exit.

## **Assembler user exit interface**

You can modify CEEBXITA to perform any function desired, although the exit must have the following attributes after you modify it:

- The user-supplied exit must be named CEEBXITA.
- The exit must be reentrant.
- The exit must be capable of executing in AMODE(ANY) and RMODE(ANY).
- The exit must be relinked with the application after modification (if you want an application-specific user exit), or relinked with z/OS Language Environment initialization/termination routines after modification (if you want an installation-wide user exit).

If a user exit is modified, you are responsible for conforming to the interface shown in Figure 193 on page 843. This user exit must be written in assembler.

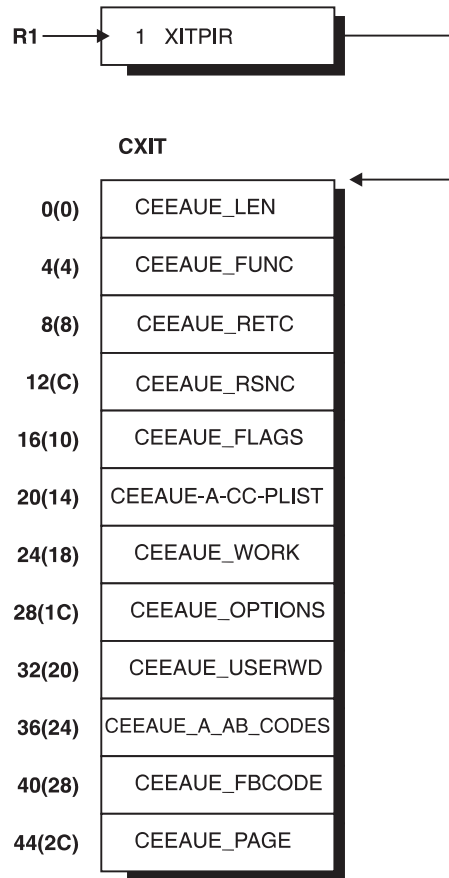

Figure 193. Interface for Assembler user exits

When the user exit is called, register 1 (R1) points to a word that contains the address of the CXIT control block. The high order bit is on. The CXIT control block contains the following fullwords:

**CEEAUE\_LEN (input parameter)**

A fullword integer that specifies the total length of this control block. For z/OS Language Environment, the length is 48 bytes.

**CEEAUE\_FUNC (input parameter)**

A fullword integer that specifies the function code. In z/OS Language Environment, the following function codes are supported:

- 1 initialization of the first enclave within a process
- 2 termination of the first enclave within a process
- 3 nested enclave initialization
- 4 nested enclave termination
- 5 process termination

The user exit should ignore function codes other than those numbered from 1 through 5.

**CEEAUE\_RETC (input/output parameter)**

A fullword integer that specifies the return or abend code. CEEAUE\_RETC has different meanings depending on the flag CEEAUE\_ABND:

- As an input parameter, this fullword is the enclave return code.

- As an output parameter, if the flag CEEAUE\_ABND is on, this fullword is interpreted as an abend code that is used when an abend is issued. (This could be either an EXEC CICS ABEND or an SVC 13.)
- If the flag CEEAUE\_ABND is off, this fullword is interpreted as the enclave return code that might have been modified by the exit.

See *z/OS Language Environment Programming Guide* for more information about how z/OS Language Environment computes return and reason codes.

**CEEAUE\_RSNC (input/output parameter)**

A fullword integer that specifies the reason code for CEEAUE\_RETCL.

- As an input parameter, this fullword is the z/OS Language Environment return code modifier.
- As an output parameter, if the flag CEEAUE\_ABND is on, CEEAUE\_RETCL is interpreted as an abend reason code that is used when an abend is issued. (This field is ignored when an EXEC CICS ABEND is issued.)
- If the flag CEEAUE\_ABND is off, this fullword is the z/OS Language Environment return code modifier that might have been modified by the exit.

See *z/OS Language Environment Programming Guide* for more information about how z/OS Language Environment computes return and reason codes.

**CEEAUE\_FLAGS (input/output parameter)**

Contains four flag bytes. CEEBXITA uses only the first byte but reserves the remaining bytes. All unspecified bits and bytes must be zero. The layout of these flags is shown in Figure 194.

<b>Byte 0</b>	x... .... - CEEAUE_ABTERM 0... .... - Normal termination 1... .... - Abnormal termination .x.. .... - CEEAUE_ABND .0.. .... - Terminate with CEEAUE_RETCL .1.. .... - Abend with CEEAUE_RETCL and CEEAUE_RSNC given ..x. .... - CEEAUE_DUMP ..0. .
<b>Byte 1</b>	00 - Reserved for future use
<b>Byte 2</b>	00 - Reserved for future use
<b>Byte 3</b>	00 - Reserved for future use

Figure 194. CEEAUE\_FLAGS format

Byte 0 (CEEAUE\_FLAG1) has the following meaning:

**CEEAUE\_ABTERM (input parameter)**

When OFF, the enclave terminates normally (severity 0 or 1 condition).

When ON, the enclave terminates with the z/OS Language Environment return code modifier of 2 or greater. This could, for example, indicate that a condition of severity 2 or greater was raised that was unhandled.

**CEEAEU\_ABND (output parameter)**

When OFF, the enclave terminates without an abend. CEEAEU\_RETC and CEEAEU\_RSNC are placed in register 15 and register 0 and returned to the enclave creator.

When ON, the enclave terminates with an abend. Thus, CEEAEU\_RETC and CEEAEU\_RSNC are used by z/OS Language Environment in the invocation of the abend. While executing in CICS, an EXEC CICS ABEND command is issued.

CEEAEU\_RSNC is ignored under CICS. The TRAP option does not affect the setting of CEEAEU\_ABND.

**CEEAEU\_DUMP (output parameter)**

When OFF and you request an abend, an abend is issued without requesting a system dump. When ON and you request an abend, an abend is issued requesting a system dump.

**CEEAEU\_STEPS (output parameter)**

When OFF and you request an abend, one is issued to abend the entire task. When ON and you request an abend, one is issued to abend the step.

**Note:** This fullword is ignored under CICS.

**CEEAEU-A-CC-PLIST (input/output parameter)**

A fullword pointer to the parameter address list of the application program.

As an input parameter, this fullword contains the register 1 value passed to the main routine. The exit can modify this value, and the value is then passed to the main routine. If runtime options are present in the invocation command string, they are stripped off before the exit is called.

If the parameter inbound to the main routine is a character string, CEEAEU-A-CC-PLIST contains the address of a fullword address that points to a halfword prefixed string. If this string is altered by the user exit, the string must not be extended in place.

**CEEAEU\_WORK (input parameter)**

Contains a fullword pointer to a 256-byte work area that the exit can use. On entry, it contains binary zeros and is doubleword-aligned. This area does not persist across exits.

**CEEAEU\_OPTIONS (output parameter)**

On return, this field contains a fullword pointer to the address of a halfword length prefixed character string that contains runtime options. These options are only processed for enclave initialization. When invoked for enclave termination, this field is ignored.

These runtime options override all other sources of runtime options except those that are specified as non-overrideable.

Under CICS, the STACK runtime option cannot be modified using the assembler user exit.

**CEEAEU\_USERWD (input/output parameter)**

Contains a fullword whose value is maintained without alteration and passed



to every user exit. On entry to the enclave initialization user exit, it is zero. Thereafter, the value of the user word is not altered by z/OS Language Environment or any member libraries. The user exit can change the value of this field and z/OS Language Environment maintains this value. This allows a user exit to initialize the fullword and pass it to subsequent user exits.

#### **CEEAEU\_A\_AB\_CODES (output parameter)**

During the initialization exit, this field contains the fullword address of a table of abend codes that the z/OS Language Environment condition handler percolates while in the (E)STAE exit. Therefore, the application is not given the opportunity to field the abend. The table consists of:

- A fullword count of the number of abend codes that are to be percolated
- A fullword for each of the particular abend codes that are to be percolated

The abend codes can be user abend codes or system abend codes. User abend codes are specified by F'uuu'. For example, if you wanted user abend 777 to be percolated, an F'777' would be coded. System abend codes are specified by X'00sss000'. Avoid specifying the values 0C0 through 0CF as 'sss'. Language Environment ignores values between 0CO and 0CF. No abend is percolated, and z/OS Language Environment condition handling semantics are in effect.

This function is not enabled under CICS.

#### **CEEAEU\_FBCODE (input parameter)**

Contains the fullword address of the condition token with which the enclave terminated. If the enclave terminates normally (that is, not because of a condition), the condition token is zero.

#### **CEEAEU\_PAGE (input/output parameter)**

Usage of this field is related to PL/I BASED variables that are allocated storage outside of AREAs. You can indicate whether storage should be allocated on a 4K-page boundary. You can specify the minimum number of bytes of storage that you want allocated. Your allocation request must be an exact multiple of 4K. The IBM-supplied default setting for CEEAEU\_PAGE is 32768 (32K).

If CEEAEU\_PAGE is set to zero, PL/I BASED variables can be placed on other than 4K-page boundaries.

CEEAEU\_PAGE is honored only during enclave initialization (that is, when CEEAEU\_FUNC is 1 or 3).

The offset of CEEAEU\_PAGE under z/OS Language Environment is different from the offset of IBMBXITA under OS PL/I Version 2 Release 3.

## **Parameter values in the Assembler user exit**

The parameters described in the following sections contain different values depending on how the user exit is used. Possible values are shown for the parameters based on how the assembler user exit is invoked.

### **First enclave within process initialization—entry**

CEEAEU\_LEN

48

CEEAEU\_FUNC

1 (first enclave within process initialization function code).

CEEAEU\_RETC

0

**CEEAE\_RSNC**

0

**CEEAE\_FLAGS**

0

**CEEAE-A-CC-PLIST**

The register 1 value from the operating system.

**CEEAE\_WORK**

Address of a 256-byte work area of binary zeros.

**CEEAE\_USERWD**

0

**CEEAE\_FBCODE**

0

**CEEAE\_PAGE**

Minimum number of storage bytes to be allocated for PL/I BASED variables (default = 32768).

### **First enclave within process initialization—return**

**CEEAE\_RETC**

0, or if CEEAE\_ABND = 1, the abend code.

**CEEAE\_RSNC**

0, or if CEEAE\_ABND = 1, the reason code for CEEAE\_RETC.

**CEEAE\_FLAGS**

CEEAE\_ABND = 1 if an abend is requested, or 0 if the enclave should continue with termination processing.

CEEAE\_DUMP = 1 if the abend should request a dump.

CEEAE\_STEPS = 1 if the abend should abend the step, or 0 if the abend should abend the task.

**CEEAE-A-CC-PLIST**

Register 1, used as the new parameter list.

**CEEAE\_OPTIONS**

Pointer to the address of a halfword prefixed character string containing runtime options, or 0.

**CEEAE\_USERWD**

Value of CEEAE\_USERWD for all subsequent exits.

**CEEAE\_A\_AB\_CODES**

Pointer to the abend code table, or 0.

**CEEAE\_PAGE**

User-specified PAGE value. Minimum number of storage bytes to be allocated for PL/I BASED variables (default = 32768).

### **First enclave within process termination—entry**

**CEEAE\_LEN**

48

**CEEAE\_FUNC**

2 (first enclave within process termination function code).

**CEEAE\_RETC**

Return code issued by the application that is terminating.

**CEEAE\_RSNC**

Reason code that accompanies CEEAE\_RETC.

**CEEAE\_FLAGS**

CEEAE\_ABTERM = 1 if the application is terminating with the z/OS Language Environment return code modifier of 2 or greater, or 0 otherwise.

CEEAE\_ABND = 0

CEEAE\_DUMP = 0

CEEAE\_STEPS = 0

**CEEAE\_WORK**

Address of a 256-byte work area of binary zeros.

**CEEAE\_USERWD**

Return value from the previous exit.

**CEEAE\_FBCODE**

Feedback code causing termination.

**First enclave within process termination—return****CEEAE\_RETC**

If CEEAE\_ABND = 0, the return code placed in register 15 when the enclave terminates.

If CEEAE\_ABND = 1, the abend code.

**CEEAE\_RSNC**

If CEEAE\_ABND = 0, the enclave reason code.

If CEEAE\_ABND = 1, the abend reason code.

**CEEAE\_FLAGS**

CEEAE\_ABND = 1 if an abend is requested, or 0 if the enclave should continue with termination processing.

CEEAE\_DUMP = 1 if the abend should request a dump.

CEEAE\_STEPS = 1 if the abend should abend the step, or 0 if the abend should abend the task.

**CEEAE\_USERWD**

The value of CEEAE\_USERWD for all subsequent exits.

**Nested enclave initialization—entry****CEEAE\_LEN**

48

**CEEAE\_FUNC**

3 (nested enclave initialization function).

**CEEAE\_RETC**

0

**CEEAE\_RSNC**

0

**CEEAE\_FLAGS**

0

**CEEAE-A-CC-PLIST**

The register 1 value discovered in a nested enclave creation.

**CEEAE\_WORK**

Address of a 256-byte work area of binary zeros.

**CEEAE\_USERWD**

The return value from previous exit.

**CEEAE\_FBCODE**

0

**CEEAE\_PAGE**

Minimum number of storage bytes to be allocated for PL/I BASED variables (default = 32768).

**Nested enclave initialization—return****CEEAE\_RETC**

0, or if CEEAE\_ABND = 1, the abend code.

**CEEAE\_RSNC**

0, or if CEEAE\_ABND = 1, the reason code for CEEAE\_RETC.

**CEEAE\_FLAGS**

CEEAE\_ABND = 1 if an abend is requested, or 0 if the enclave should continue with termination processing.

CEEAE\_DUMP = 1 if the abend should request a dump.

CEEAE\_STEPS = 1 if the abend should abend the step, or 0 if the abend should abend the task.

**CEEAE-A-CC-PLIST**

Register 1 used as the new parameter list.

**CEEAE\_OPTIONS**

Pointer to a fullword address that points to a halfword prefixed string containing runtime options, or 0.

**CEEAE\_USERWD**

The value of CEEAE\_USERWD for all subsequent exits.

**CEEAE\_A\_AB\_CODES**

Pointer to the abend code table, or 0.

**CEEAE\_PAGE**

User-specified PAGE value. Minimum number of storage bytes to be allocated for PL/I BASED variables (default = 32768).

**Nested enclave termination—entry****CEEAE\_LEN**

48

**CEEAE\_FUNC**

4 (termination function).

**CEEAE\_RETC**

Return code issued by the enclave that is terminating.

**CEEAE\_RSNC**

Reason code that accompanies CEEAE\_RETC.

**CEEAE\_FLAGS**

CEEAE\_ABTERM = 1 if the application is terminating with the z/OS Language Environment return code modifier of 2 or greater, or 0 otherwise.

CEEAE\_ABND = 0

CEEAE\_DUMP = 0

CEEAE\_STEPS = 0

**CEEAEU\_WORK**

Address of a 256-byte work area of binary zeros.

**CEEAEU\_USERWD**

Return value from previous exit.

**CEEAEU\_FBCODE**

Feedback code causing termination.

**Nested enclave termination—return****CEEAEU\_RETC**

If CEEAEU\_ABND = 0, the return code from the enclave.

If CEEAEU\_ABND = 1, the abend code.

**CEEAEU\_RSNC**

If CEEAEU\_ABND = 0, the enclave reason code.

If CEEAEU\_ABND = 1, the enclave reason code.

**CEEAEU\_FLAGS**

CEEAEU\_ABND = 1 if an abend is requested, or 0 if the enclave should continue with termination processing.

CEEAEU\_DUMP = 1 if the abend should request a dump.

CEEAEU\_STEPS = 1 if the abend should abend the step, or 0 if the abend should abend the task.

**CEEAEU\_USERWD**

Value of CEEAEU\_USERWD for all subsequent exits.

**Process termination—entry****CEEAEU\_LEN**

48

**CEEAEU\_FUNC**

5 (process termination function).

**CEEAEU\_RETC**

Return code presented to the invoking system in register 15 that reflects the value returned from the first enclave within process termination.

**CEEAEU\_RSNC**

Reason code accompanying CEEAEU\_RETC that is presented to the invoking system in register 0 and reflects the value returned from the first enclave within process termination.

**CEEAEU\_FLAGS**

CEEAEU\_ABTERM = 1 if the last enclave is terminating abnormally (that is, the z/OS Language Environment return code modifier is 2 or greater). This reflects the value returned from the first enclave within process termination (function code 2).

CEEAEU\_ABND = 1 if an abend is requested, or 0 if the enclave should continue with termination processing first enclave within process termination (function code 2).

CEEAEU\_DUMP = 0

CEEAEU\_STEPS = 0

**CEEAEU\_WORK**

Address of a 256-byte work area of binary zeros.

## CEEAE\_USERWD

The return value from previous exit.

## CEEAE\_FBCODE

The feedback code causing termination.

## Process termination—return

### CEEAE\_RETC

If CEEAE\_ABND = 0, the return code from the process.

If CEEAE\_ABND = 1, the abend code.

### CEEAE\_RSNC

If CEEAE\_ABND = 0, the reason code for CEEAE\_RETC from the process.

If CEEAE\_ABND = 1, reason code for the CEEAE\_RETC abend reason code.

### CEEAE\_FLAGS

CEEAE\_ABND = 1 if an abend is requested, or 0 if the enclave should continue with termination processing.

CEEAE\_DUMP = 1 if the abend should request a dump.

CEEAE\_STEPS = 1 if the abend should abend the step, or 0 if the abend should abend the task.

### CEEAE\_USERWD

The value of CEEAE\_USERWD for all subsequent exits.

## PL/I and C/370 compatibility

The following OS PL/I Version 2 Release 3 assembler user exits are supported for compatibility under z/OS Language Environment:

- IBMBXITA (MVS Batch version)
- IBMFXITA (CICS version)

For more information about IBMBXITA see *PL/I for MVS & VM Compiler and Run-Time Migration Guide*. These user exits are available only under C, not C++.

Default versions of the above exits are not supplied under z/OS Language Environment; instead, z/OS Language Environment supplies a default version of CEEBXITA. Table 345 describes the order of precedence if the IBMBXITA and IBMFXITA user exits are found in the same root program with CEEBXITA.

Table 345. Interaction of Assembler user exits

CEEBXITA Present	IBMBXITA Present under MVS Batch, IBMFXITA Present under CICS	Exit Driven
No	No	Default version of CEEBXITA
Yes	No	CEEBXITA
No	Yes	IBMBXITA under MVS Batch; IBMFXITA under CICS
Yes	Yes	CEEBXITA

CXIT\_FUNC in IBMBXITA will map to CEEBXITA as follows:

- CXIT\_FUNC = 1 when IBMBXITA is invoked for initial enclave initialization or nested enclave initialization

- CXIT\_FUNC = 2 when IBMBXITA is invoked for initial enclave termination or nested enclave termination

CXIT\_USERWD in IBMBXITA will persist across enclaves (for example, in system() calls).

## High level language user exit interface

z/OS Language Environment provides CEEBINT, an HLL user exit, for enclave initialization. You can code CEEBINT in z/OS XL C, PL/I, or z/OS XL C++ (subject to the restrictions in “Order of processing of user exits” on page 838), or z/OS Language Environment-conforming assembler. The HLL user exit cannot be written in COBOL. COBOL programmers can use an HLL exit written in z/OS XL C, PL/I, z/OS Language Environment-conforming assembler, z/OS XL C++ (again, subject to the restrictions in “Order of processing of user exits” on page 838), or default to the IBM-supplied default HLL user exit.

The HLL enclave initialization exit is invoked after the enclave has been established, after the Debug Tool initial command string has been processed, and prior to the invocation of compiled code. When invoked, it is passed a parameter list that conforms to the z/OS Language Environment definition. The parameters are all fullwords and are defined as follows:

### Number of arguments in parameter list (input)

A fullword binary integer.

- On entry: Contains 7.
- On exit: Not applicable.

### Return code (output)

A fullword binary integer.

- On entry: 0.
- On exit: Able to be set by the exit, but not interrogated by z/OS Language Environment.

### Reason code (output)

A fullword binary integer.

- On entry: 0
- On exit: Able to be set by the exit, but not interrogated by z/OS Language Environment.

### Function code (input)

A fullword binary integer.

- On entry: 1, indicating the exit is being driven for initialization.
- On exit: Not applicable.

### Address of the main program entry point (input)

A fullword binary address.

- On entry: The address of the routine that gains control first.
- On exit: Not applicable.

### User word (input/output)

A fullword binary integer.

- On entry: Value of the user word (CEEAEUE\_USERWD) as set by the assembler user exit.
- On exit: The value set by the user exit, maintained by z/OS Language Environment and passed to subsequent user exits.

### Exit List Address (output)

A fullword binary integer reserved for future use. This allows the establishment of one or more user exits when the enclave user exit sets this field to a list of user exits. Currently, only one user exit is supported in z/OS Language Environment.

### A\_Exits

The address of the exit list control block, `Exit_list`.

- On entry: 0.
- On exit: 0, unless you establish a hook exit, in which case you would set this pointer and fill in relevant control blocks. The control blocks for `Exit_list` and `Hook_exit` are shown in the following figure.

As supplied, CEEBINT has only one exit defined that you can establish: the hook exit described by the `Hook_exit` control block. This exit gains control when hooks generated by the PL/I compile-time `TEST` option are executed. You can establish this exit by setting appropriate pointers (`A_Exits` to `Exit_list` to `Hook_exit`). Figure 195 illustrates the `Exit_list` and `Hook_exit` control blocks.

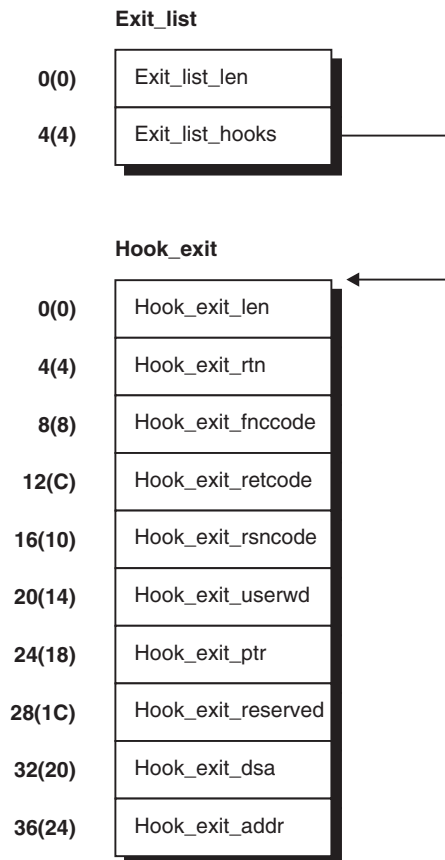

Figure 195. `Exit_list` and `hook_exit` control blocks

The control block `Exit_list` exit contains the following fields:

#### `Exit_list_len`

The length of the control block. It must be 1.

#### `Exit_list_hooks`

The address of the `Hook_exit` control block.



The control block for the hook exit must contain the following fields:

**Hook\_exit\_len**

The length of the control block.

**Hook\_exit\_rtn**

The address of a routine you want invoked for the exit. When the routine is invoked, it is passed the address of this control block. Because this routine is invoked only if the address you specify is nonzero, you can turn the exit on and off.

**Hook\_exit\_fnccode**

The function code with which the exit is invoked. This is always 1.

**Hook\_exit\_retcde**

The return code set by the exit. You must ensure it conforms to the following specifications:

- 0 Requests that Debug Tool be invoked next
- 4 Requests that the program resume immediately
- 16 Requests that the program be terminated

**Hook\_exit\_rsncode**

The reason code set by the exit. This is always zero.

**Hook\_exit\_userwd**

The user word passed to the user exits.

**Hook\_exit\_ptr**

An exit-specific user word.

**Hook\_exit\_reserved**

Reserved.

**Hook\_exit\_dsa**

The contents of register 13 when the hook was executed.

**Hook\_exit\_addr**

The address of the hook instruction executed.

## Usage requirements

1. The user exit must not be a main-designated routine. For example, it cannot be a z/OS XL C or a z/OS XL C++ `main()` function.
2. The HLL exit routines must be linked with compiled code. If you do not provide an initialization user exit, an IBM-supplied default, which returns control to your application, is linked with the compiled code.
3. The exit cannot be written in COBOL/370.
4. The exit should be coded so that it returns for all unknown function codes.
5. z/OS XL C constructs such as the `exit()`, `abort()`, `raise(SIGTERM)`, and `raise(SIGABRT)` functions terminate the enclave.
6. A PL/I EXIT or STOP statement terminates the enclave.
7. Use the callable service IBMHKS to turn hooks on and off. For more information about IBMHKS, see *PL/I for MVS & VM Compiler and Run-Time Migration Guide*.
8. When CEEBINT is written in C/C++, the following information must be coded so that SMP/E can maintain the CSECT and properly link the intended user exit:

```
#pragma map(CEEBINT,"CEEBINT")
```

---

## Chapter 51. Using the z/OS XL C MultiTasking Facility

This chapter describes how to use the MultiTasking Facility (MTF) with z/OS XL C. It explains how to organize, code, compile, link, and run a program using MTF. It also lists restrictions while using MTF.

MTF is a facility available under z/OS that can be used by application programs to improve turnaround time on multiprocessor and attached-processor configurations. When a program uses MTF on such a system, the elapsed time required to run the program can be reduced. You can run tasks, which can run independently of each other, simultaneously.

MTF is easy to use and requires very little knowledge of the multitasking capabilities upon which it depends. From the programmer's perspective, multitasking facilities are available through the library functions of z/OS XL C. Because of this simplicity, it is easy to introduce MTF to existing applications and code new MTF applications to gain the benefits of multitasking.

### Notes:

1. Except for a few differences, the MTF support for z/OS XL C is the same as for the equivalent FORTRAN multitasking facilities. MTF is not supported under CICS, IMS, DB2, C++, or z/OS UNIX. In addition, IPA is not supported in an MTF environment.
2. XPLINK is not supported in an MTF environment.
3. AMODE 64 applications are not supported in an MTF environment.

---

## Organizing a program with MTF

MTF takes advantage of the multitasking capabilities of the operating system to enable a single z/OS XL C application program to use more than one processor of a multiprocessing configuration simultaneously. The z/OS operating system organizes all work into units called *tasks*. These tasks are used by the operating system to assign work to the processors of the multiprocessor configuration.

MTF's facilities allow a single z/OS XL C application to be organized so it can be run in a *main task* and in one or more *subtasks*. As a result of this organization, the system can schedule these individual tasks to run simultaneously. This can significantly reduce the elapsed time needed to run the program.

When a program is organized in this manner, the main task runs the part of the program that controls the overall processing. This part is referred to as the *main task program* throughout this manual.

The subtasks run the portions of the program that can run independently of the main task program and of each other. These portions of the program are referred to as *parallel functions*. The library functions provided by MTF allow the main task program to schedule parallel functions and allow them to run independently. Parallel functions are queued for execution on the next available subtask. Scheduling a parallel function does not require that there be a free subtask at the time of the scheduling. MTF allows the main task program to schedule more parallel functions than there are actual MVS subtasks.

The parallel functions are coded the same way as normal C functions, with the exception of a few rules discussed in “Designing and coding applications for MTF” on page 863. In particular, parallel functions cannot issue MTF calls.

MTF applications are link-edited as two separate load modules: a main task load module (containing the main task program) and a parallel load module (containing all parallel functions).

z/OS XL C provides the following MTF functions (for details, refer to *z/OS XL C/C++ Runtime Library Reference*):

- `tinit()` to initialize the MTF environment
- `tsched()` to schedule parallel functions to run
- `tsyncro()` to synchronize the completion of parallel functions
- `tterm()` to terminate all executing parallel functions.

z/OS XL C also provides the header file `mtf.h`, which must be included in your main task program if you are going to use the MTF facilities. The `mtf.h` header file contains the macros `MTF_ANY` and `MTF_ALL`, as well as the error-return codes and prototypes for library functions.

## Ensuring computational independence

To use multitasking successfully, the parallel functions must have *computational independence*. This means that no data modified by either the main task program or a parallel function is examined or modified by a parallel function that might be running simultaneously.

Figure 196 is a graphic example of hypothetical data in an array subscripted by I, J, and K. Each of the three divisions of the box represents a section of the array that can be operated on independently of the other sections. The same parallel function could be scheduled three times, with each instance of the function processing one of the three sections of the array.

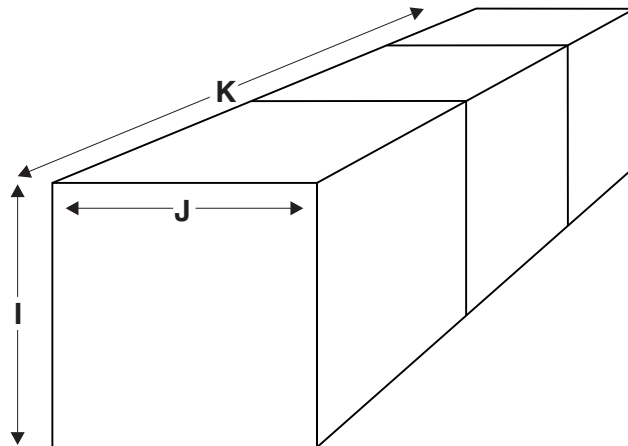

Figure 196. Computational independence

Your application may not have computational independence along the same subscript axis of K, as in this picture. The divisions might have been along one of the other subscript axes, I or J. Also, the computational independence in your application may not fall into neat, box-like divisions.

It is also possible to have computational independence that is not based on sections of the same array, but rather on separate arrays (perhaps with completely different types of data), the values of which do not depend on each other. In this case, separate parallel functions could be scheduled, with each function processing its own unique data.

Computational independence also applies to input/output files. One parallel function should not use a file while another is updating it. However, different functions can successfully read the same file. No single file pointer should be used concurrently by multiple parallel functions, because the behavior is undefined in such a case.

## Running a C program without MTF

The following diagrams illustrate the way a z/OS XL C program runs without multitasking. The program and its functions must run in a strictly sequential manner, function following function, using one processor at a time. Consequently, your program takes more elapsed time to complete than it would if it could use several processors at the same time.

For example, as Figure 197 shows, without multitasking, the z/OS XL C program and all its functions can only use one processor. While running, your program may be switched back and forth between the processors, but it can only run on one processor at a time.

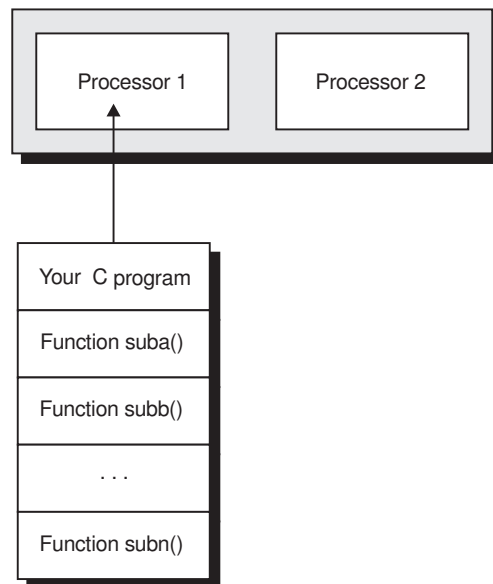

Figure 197. Example of a C program running without MTF

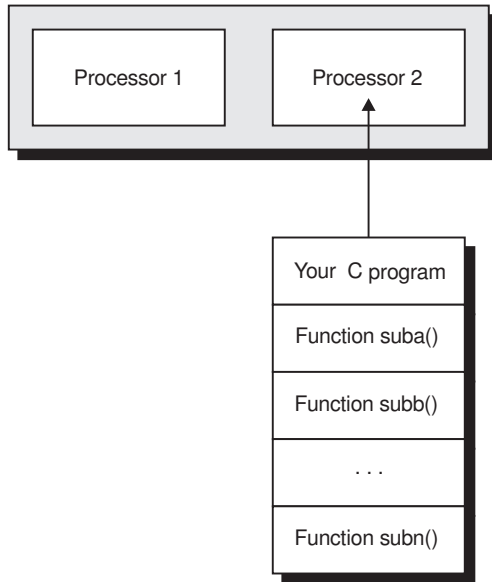

Figure 198. Example of a C program running without MTF (Part 2)

## Running a C program with MTF

To illustrate the concept of multitasking, this section shows three examples of running a z/OS XL C program with MTF. These examples show programs using:

- One parallel function
- Two different functions
- Two or more instances of the same function

Each example provides an illustration of how the processors are used and how the program is organized to accomplish the particular use of the processors.

## Running a C program with one parallel function

If your C program uses MTF, the main task program and a computationally-independent parallel function can run concurrently.

### Processor use

In Figure 199 on page 859, only the function suba has computations that can be done independently of the main task program, which includes the C main program plus its functions. Note that the arrows to Processor 1 and Processor 2 are for illustration only. The main task program could have run on Processor 2 and the parallel function, suba, on Processor 1; in fact, while they run, they may be switched between the processors.

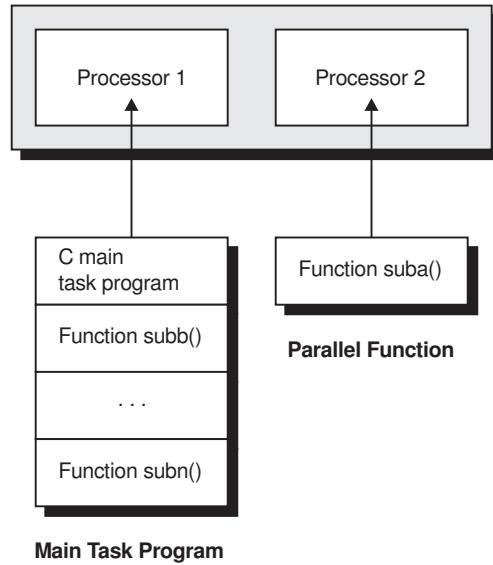

Figure 199. Processor usage with one parallel function

### Sample program

With the appropriate MTF request, the parallel function, `suba`, is scheduled to run in a subtask. As Figure 200 on page 860 shows, the MTF functions perform the following tasks:

- 1** `tinit()` names the parallel load module `plmod` and specifies one subtask.
- 2** `tsched()` schedules the parallel function `suba` to run. `suba` is computationally-independent of the main task.
- 3** At this point, `tsyncro()` makes the main task program wait until `suba` is finished before the main task program continues.

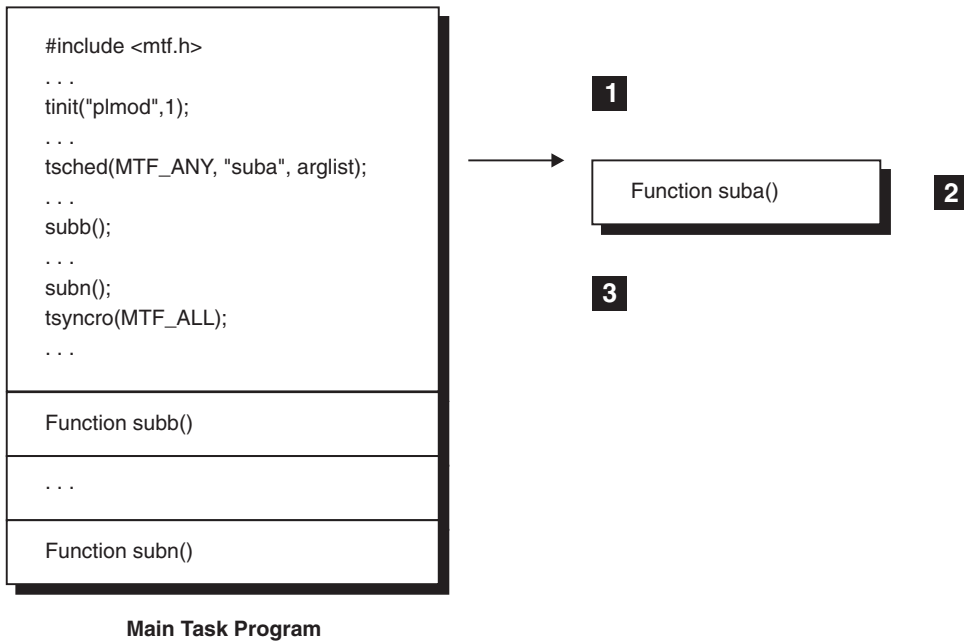

Figure 200. Sample program using one parallel function

## Running a C program with two different parallel functions

If your C program uses MTF, the main task program and several different computationally-independent parallel functions can run concurrently.

### Processor use

In Figure 201, functions `suba` and `subc` are independent of each other and of the main task program. The arrows to Processors 1, 2, and 3 are for illustration only. The main task program and the parallel functions could run on any of the processors.

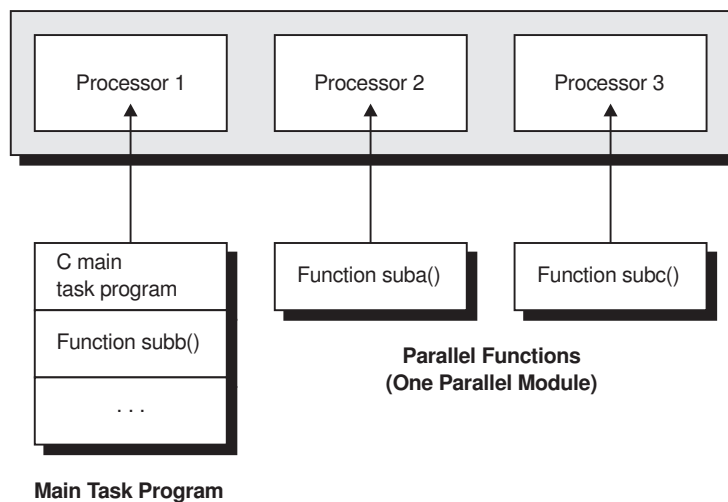

Figure 201. Processor usage with two parallel function

## Sample program

Figure 201 on page 860 shows a sample program. The logic is similar to that for only one parallel function and can be extended to as many parallel functions as necessary to complete the logic of the program.

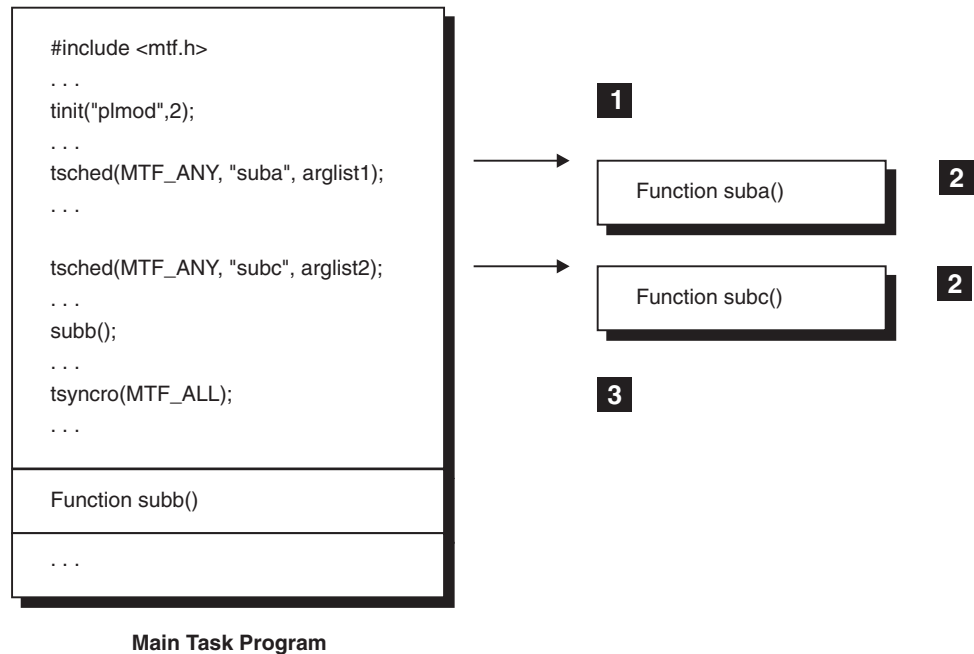

Figure 202. Sample program using two parallel functions

- 1** `tinit()` names the parallel load module `plmod` and specifies two subtasks.
- 2** Each call to `tsched()` schedules one of the parallel functions, passing different data to each for processing. `suba` and `subc` are computationally-independent parallel functions.
- 3** At this point, `tsyncro()` makes the main task program wait until both `suba` and `subc` are finished before the main task program continues its processing.

## z/OS XL C with multiple instances of the same parallel function

If your C program uses MTF, the main task program and multiple instances of the same parallel function can run concurrently.

### Processor use

In Figure 203 on page 862, parallel function `suba` has data you can divide, so two instances of `suba` run independently of the main task program and of each other.



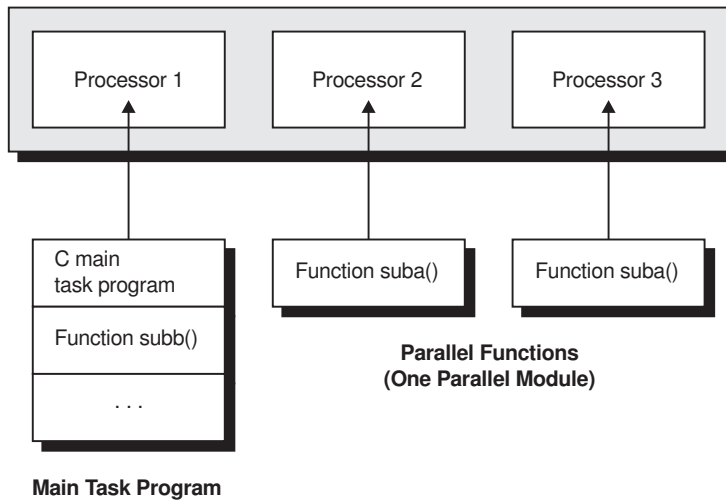

Figure 203. Processor use with multiple instances of the same parallel function

### Sample program

As Figure 204 on page 863 shows, the MTF functions perform the following tasks:

- 1** `tinit()` names the parallel load module `plmod` and specifies two subtasks.
- 2** Each call to `tsched()` schedules one instance of the parallel function to run and supplies separate data to be processed by that instance of `suba`. The data to be processed by each instance of the parallel function could be two different sections of the same array. Both instances of `suba` are computationally-independent of the main task program and each other, because each instance of `suba` processes different data.
- 3** At this point, `tsyncro()` makes the main task program wait until all instances of `suba` finish before the main task program continues.

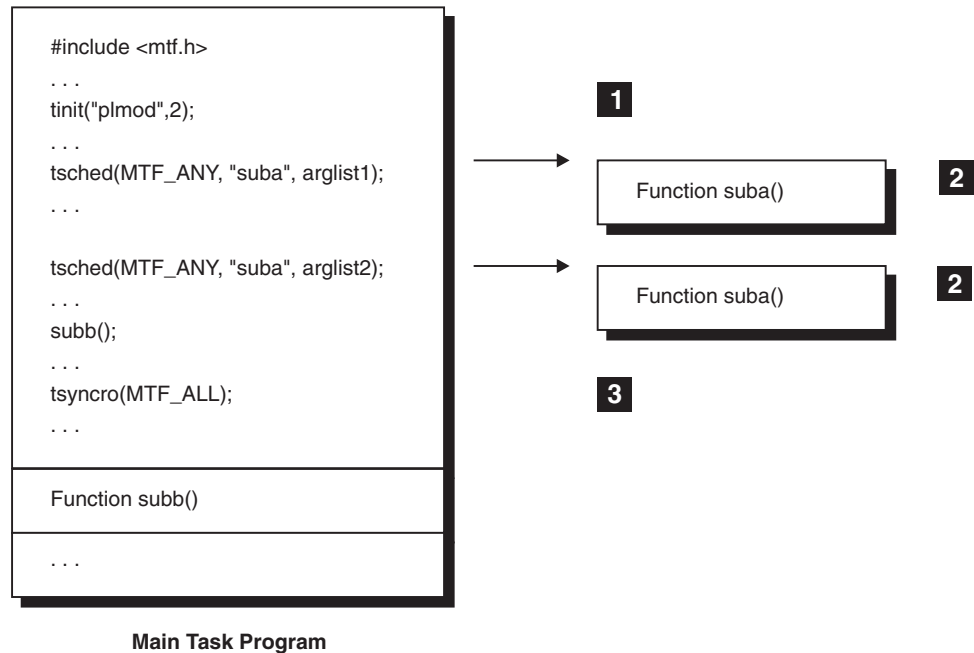

Figure 204. Sample program using multiple instances of the same parallel function

## Designing and coding applications for MTF

You can use the following steps when preparing a z/OS XL C application to work with MTF:

1. Identify computationally-independent code
2. Create parallel functions
3. Insert calls to parallel functions in main task program

New programs can be designed to use MTF, and existing programs can be reconstructed.

### Step 1: Identifying computationally-independent code

The first step in adapting an application program for MTF is to identify groups of computations that can be performed in parallel. To produce correct results, the computations that are done in parallel must be computationally-independent. This is further explained under "Ensuring computational independence" on page 856.

### Step 2: Creating parallel functions

After the segments of code that are computationally-independent are identified, they are separated from the main task program and placed in parallel functions. A parallel function is coded as a normal C function that follows several rules required for correct operation with MTF. Besides to data independence, there are rules for:

- Parallel functions
- Calling other functions
- Separate storage for separate modules
- Passing data

- Input and output
- Exception/signal handling
- Function termination

### **Parallel functions**

- A parallel function must be written only in C.
- The return value of a parallel function must be `void`. If a parallel function attempts to return a value, the behavior will be undefined.
- External parallel function names must be 8 characters or shorter in length and will be uppercased.

### **Calling other functions**

- A parallel function may actually be coded as a series of functions that call one another. All of these functions operate in the parallel function's subtask environment and must follow the rules of a parallel function except that they can be written in assembler as well as C, and they can have return values.
- A parallel function cannot call the MTF library functions `tinit()`, `tsched()`, `tsyncro()`, or `tterm()`. Such calls can only be used in the main task.

### **Separate storage for separate modules**

- Every MTF application consists of two modules: the main task module which runs on the main task, and the parallel module that runs on the subtask(s). Each task (main or sub) has its own unique runtime storage structure consisting of ISA, heap, and residual storage. Each task has:
  - Separate writable static (whether reentrant or not)
  - Separate library-internal storage (for example, file and storage management control blocks)
  - Separate exception and signal-handling environment (for example, `errno`, `__amrc`)
- Usually, functions must abide by the restrictions inherent in this arrangement. The remaining rules in this section mostly arise from this arrangement.

## Single User Application/Single Address Space

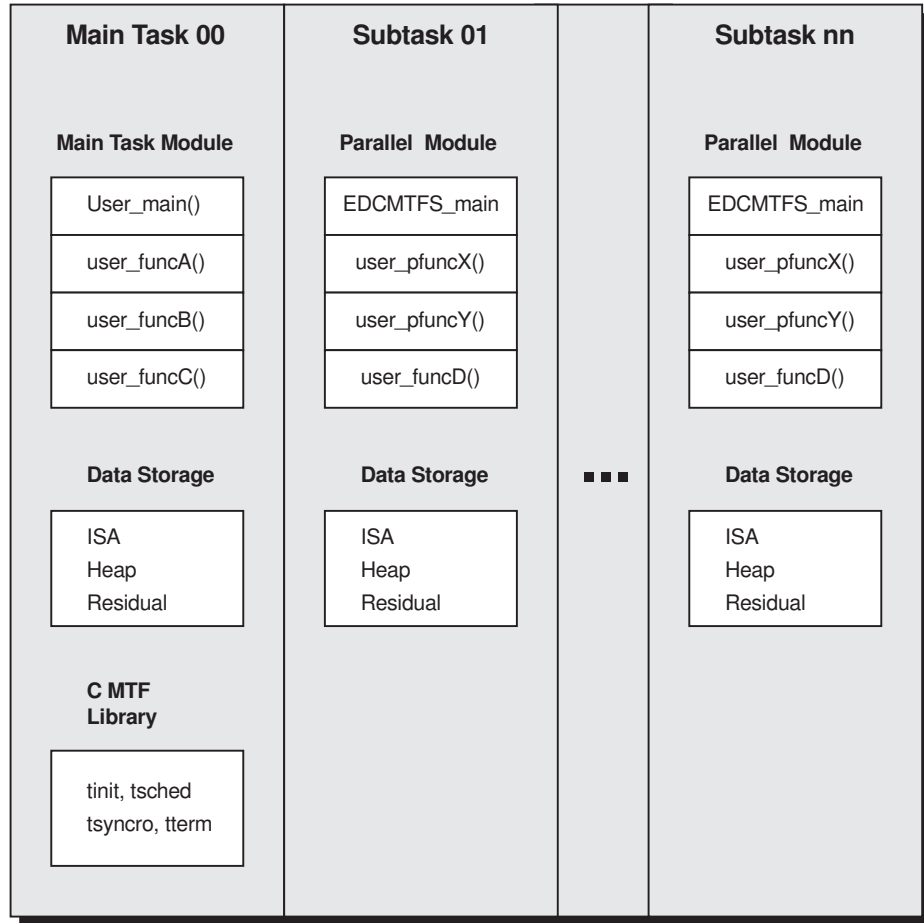

### Notes:

- Each task has private and separate storage structure that leads to most of the parallel function idiosyncrasies:
  - All file operations from same task.
  - Storage must be malloc() or free()d from same task.
  - Independent signal handling environments.
- MTF library functions are only operational in the main task.
- call/return used for invocation within a task.
- MTF only supports parallel load modules in a PDS. Parallel load modules in a PDSE are NOT supported.

Figure 205. Basic MTF layout

### Passing data

- A parallel function is always invoked in its last-used state. If, for example, a parallel function has defined a static variable with an initializer, then the variable has that value the first time the parallel function executes on a given task. Should the value be modified, the modification is available the next time that parallel function is run only if the function is scheduled to the same task. If

you don't schedule the parallel function to the same task, you cannot depend upon residual values from previous invocations of the function.

- Data can be passed between the main task program and parallel functions, and between parallel functions by passing a pointer to the storage area as a parameter. Care must be taken to ensure that the data remains valid and available until completion of the particular parallel function instance being scheduled.
- If heap storage is obtained on a given task, it must be freed on that task and no other. Other tasks may be given access to that storage by passing pointers but no other task can use that pointer to free the storage.

## Input/Output

- File pointers must not be shared across subtasks. A given file pointer must only be used (for file access and closing) on the same task on that it was created (using `fopen()`). File pointers must be utilized as a serial resource. z/OS XL C does not protect against misuse, and a program will have unpredictable behavior if this rule is not enforced.
- Each parallel function updates (writes or changes) a file as if it had complete control over the file; therefore, there should be *no* simultaneous read or update of a given file while any function on any task is updating that file (even if separate file pointers are used).
- Memory files cannot be shared across subtasks.

## Exception/Signal handling

- The parallel functions on the subtasks run with `TRAP(ON)` runtime option, and each has a signal handling environment entirely independent from that of each other task. All signals are initialized to default handling on each task, and can be modified for a given task only through a signal statement from a parallel function on that task.
- All signal interrupts are eligible to be raised from the operating system or by the `raise()` function during execution of parallel functions. All signals, however, require special handling in the case of parallel functions because of the requirement that parallel functions always return normally. Signals must either be ignored or a handler must be established that does not terminate the program. If these signals are left to default handling or a handler is established that terminates the program, MTF will treat this as an abnormal termination of the parallel function.

## Function termination

- Parallel functions run as called functions (from EDCMTFS, the z/OS XL C library supplied main function for parallel modules) and must terminate by simple return (to EDCMTFS). For more information on EDCMTFS, see "Creating the parallel functions load module" on page 873.
- Termination with `exit()` and `abort()` calls is invalid because these functions interfere with EDCMTFS operation and they are treated by MTF as abnormal terminations.
- On the first valid call to MTF (`tsched()`, `tsyncro()`, `tterm()`) from the main task program after a parallel function has abnormally terminated (via `exit()/abort()` or otherwise) MTF will:
  - Abort all parallel functions scheduled or in progress
  - Remove the MTF environment
  - Return `ETASKABND` on that MTF call

A subsequent `tterm()` call is unnecessary and will simply return `EINACTIVE`. A `tinit()` can be reissued, but depending on the severity of the condition that caused the `ETASKABND`, the `tinit()` may or may not be successful.

### Step 3: Inserting calls to parallel functions

In the main task, insert a call to `tinit()` to initialize the MTF environment before to any other MTF function call, or after `tterm()` is invoked. Replace each segment of code that was identified for parallel computation with a call to `tsched()` which schedules the corresponding parallel function. If more parallel function instances are scheduled than tasks are currently available, the additional instances are queued for subsequent execution in the order in which they were scheduled. They are queued for any task or to a particular task according to the `task_id` parameter supplied on the `tsched()` call. If parallel operation is to be achieved by scheduling the same function multiple times with different data, the function call may be placed within a loop.

The arguments passed to the parallel function may be:

- A variable
- An array element
- An array name
- A constant
- A structure

The following items must not be used as the arguments supplied to the parallel function using `tsched()`:

- Function pointers
- A pointer to data or storage that will be modified or released before a `tsyncro()`.

After inserting calls to the parallel functions, insert a call to `tsyncro()` wherever the program requires that any subtask, one particular subtask, or all of the subtasks have finished executing the parallel functions previously scheduled to them. As the last MTF call, insert a call to `tterm()` before to exit/return from the main task program to remove the MTF environment.

To properly use MTF from the main task program it is necessary to include the `mtf.h` header file before to the first MTF call in your program. MTF calls themselves can be issued from non-main as well as main functions within the main task program, subject only to the restrictions already described above. MTF calls, however, can only be issued from C functions and not from functions written in any other language.

The next sections show examples of how to change existing C programs to use MTF following the steps just outlined.

## Changing an application to use MTF

The following examples show how to change an application to use MTF by creating parallel functions and inserting calls to these functions.

### Example 1

Figure 206 on page 868 shows a computation of the dot product on two long one-dimensional arrays of data. The processing within the loop structure may be separated so that the dot product is not a result of serial calculations but a result of parallel calculations. This is because the first part of the array is not dependent on

the results computed in any other section of the array. Thus the calculations are therefore computationally independent of each other, and can be performed at the same time.

---

```
double dotprod(double *a, double *b, int len)
{
    int i;
    double res = 0;

    for (i=0; i < len; ++i)
        res += *a++ * *b++;

    return(res);
}
```

---

*Figure 206. Identifying Computationally-Independent Code*

### Create parallel functions

The segments of the program that have been identified to run as parallel functions are then recoded as new z/OS XL C functions. In this case, there will be one parallel function, multiple instances of which will be scheduled. The parallel function corresponding to the code in Figure 206 now looks like Figure 207.

---

```
void pdotprod(double *a, double *b, int len, int m, int n, double *pres)

    /* m = the section of the array */
    /* n = the number of subtasks. n must be a factor of len */

{
    int i, from, to;

    *pres = 0;

    /* Determine which section of the array to operate on */
    from = (m-1) * len / n;
    to   = (m * len) / n;

    /* Calculate the partial result on part of the array */
    for (a+= from, b+=from, i=from; i < to; ++i)
        *pres += *a++ * *b++;
}
```

---

*Figure 207. Sample code as a parallel function*

The variables `to` and `from` are used to determine on which part of the array the parallel function is to perform.

### Insert calls to parallel functions

The segments of the program that have been removed to form parallel functions are replaced by calls to these new parallel functions. For the sample code in Figure 206, `sub:exph.` is scheduled for each subtask that will be used at run time. In order to do this, the computations controlled by the `k` index must be divided so that each instance of the function `sub` operates on a different part of the original range of the `k` variable. See Figure 208 on page 869 for an example of how two instances of a parallel function can be scheduled.

---

```

#include <mtf.h>;

double dotprod(double *a, double *b, int len)
{
:
    int i;
    double res = 0;
    double pres[MAXTASK];

    /* Schedule the parallel functions according to */
    /* how many subtasks exist */
    for (i=1; i < n; ++i)
        tsched(MTF_ANY,"pdotprod",a,b,len,i,n,&pres[i-1]);

    /* Perform the calculations on the last part of the array */
    pdotprod(a,b,len,n,n,&pres[n-1]);

    /* Wait until all of the partial results are determined */
    tsyncro(MTF_ALL);

    /*Add all the partial results to determine the final dot product*/
    for (i=0;i < n; ++i)
        res += pres[i];

    return(res);
}

```

---

*Figure 208. Scheduling instances of a parallel function*

Also, within the main task program, the subtasks must be initialized and eventually terminated as shown in Figure 209.

---

```

#include <mtf.h>

int main(void)
{
:
/* other code */
/* Attach and initialize a subtask */
tinit(load_sub_name, n);

:
    result = dotprod(vector1,vector2,len);

:
/* Terminate subtasks */
tterm();
/* more code */
}

```

---

*Figure 209. Main task program to call dot product function*

## Example 2

Not all application programs contain parallelism within the iterations of a loop structure. The following example illustrates parallel computations that appear as different segments of code in the original program. Also illustrated is the use of pointer arguments for passing data, and I/O operations to files in parallel functions.

Figure 210 on page 870 (program CCNGMT1) shows two calls to the same function that performs the dot product on the values in two files of data. The values are



read from each file and the function performs the dot product upon these values. The loop ends when the end of either file is reached. The two computations are independent of each other and thus can be performed simultaneously in two different parallel functions.

---

```
/* MTF example 2 */
#include <stdio.h>

void fdotprod(char *fn1, char *fn2)
{
    int i, res1;
    double result=0, val1, val2;
    FILE *file1, *file2;

    file1 = fopen(fn1, "r");
    file2 = fopen(fn2, "r");

    while (1)
    {
        res1 = fscanf(file1, "%lf", &val1);
        res1 += fscanf(file2, "%lf", &val2);
        if (res1 != 2)
            break;
        result += val1 * val2;
    }
    if (res1 == 1)
        printf("Error: Files of unequal length\n");
    else
        printf("Result: %lf\n", result);
}

int main(void)
{
    fdotprod("a.input", "b.input");
    fdotprod("c.input", "d.input");

    return(0);
}
```

---

*Figure 210. Sample code to be changed to use MTF*

### **Create parallel functions**

The `fdotprod` routine is identified as a parallel function so it is recoded as a new C function in a separate file. Data is passed from the main function to the parallel functions by means of pointer arguments. The main task program (CCNGMT2) is shown in Figure 211 on page 871. The parallel functions are shown in Figure 212 on page 872 (sample program CCNGMT3).

---

```

/* MTF example 2 */
/* part 2 of 2-other file is CCNGMT1 */

#include <stdio.h>
#include <mtf.h>

int main(void)
{
    tinit("plmod", 2);
    tsched(MTF_ANY, "fdotprod", "a.input", "b.input");
    tsched(MTF_ANY, "fdotprod", "c.input", "d.input");
    tsyncro(MTF_ALL);
    tterm();

    return(0);
}

void fdotprod(char *fn1, char *fn2)
{
    int i, res1;
    double result=0, val1, val2;
    FILE *file1, *file2;

    file1 = fopen(fn1, "r");
    file2 = fopen(fn2, "r");

    while(1)
    {
        res1 = fscanf(file1, "%lf", &val1);
        res1 += fscanf(file2, "%lf", &val2);
        if (res1 != 2)
            break;
        result += val1 * val2;
    }
    if (res1 == 1)
        printf("Error: Files of unequal length\n");
    else
        printf("Result: %lf\n", result);
}

```

---

*Figure 211. Sample code (main routine)*

---

```

/* MTF example 2 */
/* part 2 of 2-other file is CCNGMT2 */
#include <stdio.h>

void fdotprod(char *fn1, char *fn2)
{
    int i, res1;
    double result=0, val1, val2;
    FILE *file1, *file2;

    file1 = fopen(fn1, "r");
    file2 = fopen(fn2, "r");

    while(1)
    {
        res1 = fscanf(file1, "%lf", &val1);
        res1 += fscanf(file2, "%lf", &val2);
        if (res1 != 2)
            break;
        result += val1 * val2;
    }
    if (res1 == 1)
        printf("Error: Files of unequal length\n");
    else
        printf("Result: %lf-n", result);
}

```

---

*Figure 212. Sample code (routine to create parallel functions)*

---

## Compiling and linking programs that use MTF

Programs that use MTF run using two MVS load modules: a load module that contains the main task program, and a load module that contains the parallel functions. You compile and link-edit the main task program in the same procedure as non-MTF C programs. The parallel function is compiled in the same procedure as non-MTF C programs and is linked with EDCMTFS.

### Creating the main task program load module

The main task program load module is the load module that first receives control when MVS starts running your program. It is the load module named in the PGM keyword of the EXEC statement. This load module contains your application's C main() function plus all other functions that are to run as part of the main task. The MTF functions can be invoked from any of the C functions contained in the main task load module and do not necessarily have to be invoked from the C function called main().

The procedures that you usually use to compile and link-edit a z/OS XL C program can be used to create the main task program load module. For example, the following JCL sequence (see Figure 213 on page 873) uses the standard z/OS XL C cataloged procedure EDCCL to compile and link-edit the C source for the main task program (stored in data set USERPGM.C(MTASKPGM)) and create a main task program load module named MTASKPGM in data set USERPGM.LOAD.

---

```
//MTASKPGM EXEC EDCCL,
//          INFILE='USERPGM.C(MTASKPGM)',
//          OUTFILE='USERPGM.LOAD(MTASKPGM),DISP=OLD'
```

---

Figure 213. Sample JCL to compile and link main task program

## Creating the parallel functions load module

The parallel functions load module is the load module named in the call to the MTF library function `tinit()`. This single load module contains all of your main task program's parallel functions. It must not contain any user's C `main()` programs. z/OS XL C itself provides the EDCMTFS module to act as the C `main()` function in the parallel module. EDCMTFS controls processing of the parallel functions as they are scheduled (by way of `tsched()` calls) to the subtasks. The source code for the EDCMTFS module is included in Figure 215 on page 874.

**Note:** The executable module for parallel function program must be a load module (in a PDS data set), created using the linkage editor (and prelinker if required due to the presence of C++ code or C code compiled with the RENT option). The MTF library functions used to access the parallel functions are not compatible with a program object executable module (in a PDSE data set).

The procedures that you usually use to compile and link-edit a z/OS XL C program must be modified such that the library module CEESTART will be the entry point of the parallel functions load module.

When you link-edit this load module, include the following linkage editor control statements:

```
INCLUDE SYSLIB(EDCMTFS)
ENTRY CEESTART
```

For example, the JCL sequence in Figure 214 uses the standard z/OS XL C cataloged procedure EDCCL to compile and link-edit the C source for the parallel functions and create a parallel functions load module named PLMOD in data set USERPGM.LOAD. This load module contains the module EDCMTFS, and has EDCMTFS as the load module's entry point.

---

```
//MTASKPGM EXEC EDCCL,
//          INFILE='CBC.SCCNSAM(CCNGMT2)',
//          OUTFILE='USERPGM.LOAD(CCNGMT2),DISP=SHR'
/*
//PFUNC EXEC EDCCL,
//      INFILE='CBC.SCCNSAM(CCNGMT3)',
//      OUTFILE='USERPGM.LOAD(PLMOD),DISP=SHR'
//LKED.SYSLIN DD
//          INCLUDE SYSLIB(EDCMTFS)
//          ENTRY CEESTART
/*
```

---

Figure 214. Sample JCL to compile and link parallel functions

**Note:** First, we have a step that compiles and link-edits the main task program.

The addressing mode is subject to normal consideration as described in the *z/OS Language Environment Programming Guide*.

## Specifying the linkage-editor option

Do not specify the NE linkage-editor option when link-editing the parallel functions load module. MTF cannot schedule parallel functions that are contained in a load module link-edited with the NE option.

## Modifying runtime options

You can alter the #pragma runopts options STACK and HEAP within the EDCMTFS module for each subtask, but you must recompile the module under the same name. The source code for EDCMTFS is shown in Figure 215.

---

```
/*
*****
/* Modify the isa/isainc/heap subparameters in the following line */
/* as required to meet your needs. Ensure that your version (compiled*/
/* and linked) is then accessed in your link-edit of the parallel */
/* module in place of the prebuilt EDCMTFS found in SCEELKED. */
*****
#pragma runopts(STACK(8K,4K,ANY,FREE),HEAP(4K,4K,ANY,FREE))
/*
*****
/* The following lines must remain unmodified to ensure proper */
/* operation of MTF. */
*****
#pragma runopts(TRAP(ON),RPTSTG(OFF),\
               (STAE,SPIE,NOREPORT,NOTEST,\
                ARGPARSE,REDIR,NOEXECOPS)
int main(int argc, char **argv) { return tsetsbt(argc,argv); }
```

---

Figure 215. Source code for EDCMTFS

You can also add a #pragma runopts statement with the LIBRARY and VERSION options to EDCMTFS, if required.

---

## Running programs that use MTF

To run your program, use the usual MVS JCL for z/OS XL C programs, plus a few additional JCL statements that are required to run MTF.

### STEPLIB DD statement

You must ensure that the library containing the load modules is specified on the STEPLIB DD statement in your JCL, as well as the other libraries usually specified, as follows:

```
//STEPLIB DD DSN=user.dsn,DISP=SHR
```

*user.dsn*

name of the load module library that contains the parallel functions load module. The parallel functions load module (*parallel\_loadmod\_name*), specified on the call to `tinit()`, must be in this data set. You must allocate the ddname EDCMTF to the *user.dsn* data set as well as adding *user.dsn* to the STEPLIB concatenation list.

### DD statements for standard streams

For standard streams, MTF assigns a unique runtime output file to each parallel function. These output files contain diagnostic messages that the library can issue while the parallel functions are running. They also contain output directed to the standard streams (`stderr` and `stdout`) by parallel functions and input from the standard stream `stdin`.

Because these files are automatically allocated while the program is running, you need not supply DD statements for them unless you wish to override the default device type or other file characteristics. The default device type is a terminal in TSO or SYSOUT=\* in batch.

If you do supply DD statements, use the following ddnames:

- `stdin $stn$`  for files containing input for operations such as `getc()`
- `stderr $stn$`  for files containing diagnostic messages
- `stdout $stn$`  for files containing output from operations such as `printf()`

Where *stn* is the 2-digit subtask number; that is, 01, 02, 03, and so on. Thus, for example, if you had four subtasks and the first two used `printf()` functions, you would use the ddnames `stdout01`, `stdout02`, `stderr01`, `stderr02`, `stderr03`, and `stderr04`.

## Example of JCL

An example of the runtime JCL to run a program that uses MTF is shown in Figure 216. This figure shows the JCL that is unique to running MTF, as well as the other JCL the program would typically require. (Some programs might require additional DD statements.)

---

```
//GO          EXEC PGM=MTASKPGM
//STEPLIB DD  DSN=USERPGM.LOAD,DISP=SHR
//STDIN01 DD  DSN=USERPGM.INPUT,DISP=SHR
//STDOUT02 DD  SYSOUT=S,DCB=(RECFM=F)
```

---

Figure 216. Example runtime JCL

MTASKPGM is the name of the main task program load module, and is the load module that gets control when MVS first starts running the program. In this example, this load module is contained in data set USERPGM.LOAD, which is referred to by the STEPLIB DD statement. USERPGM.LOAD also contains the parallel functions.

The STDIN01 DD statement specifies the data set that contains the program's input data for the first task. The STDOUT02 DD statement specifies that printed output aside from runtime error messages from the second subtask is to be written to SYSOUT class S and that the record format is to be fixed-length. These DD statements are necessary only if you do not want to accept the defaults.

## Debugging programs that use MTF

Debug Tool can be used to interactively debug your main task program. It cannot, however, be used to debug your parallel functions.

## Avoiding undesirable results when using MTF

To prevent undesirable results, be aware of the following concerns and restrictions:

- MTF only supports parallel load modules in a PDS. Parallel load modules in a PDSE are NOT supported.
- Do not update a file with one task if the other tasks read the same file. Files can be destroyed if this is attempted.
- The following products should not be used from the main task or any subtasks while MTF is active:
  - Information Management System (IMS)

- The CICS command level interface
- The following products should not be used from subtasks while MTF is active but can be used from the main task:
  - Data Window Services (DWS)
  - Interactive System Productivity Facility (ISPF)
  - Graphical Data Display Manager (GDDM)
- All library functions can be issued from the main task program.
- The following library functions should not be issued from parallel functions (see “Function termination” on page 866):
  - `exit()`
  - `abort()`
  - `atexit()`
- The following library functions can be used with some restrictions from parallel functions:
  - `setjmp()/longjmp()` can be used from within any task/subtask but must not be used across tasks. That is, the stack environment saved via `setjmp()` on a given task may be restored by a `longjmp()` from that task but from no other task.
  - `setlocale()/localeconv()` are only effective within a task. Each task has its own distinct locale information. Thus `setlocale()/localeconv()` issued from one task have no effect on such functions issued from other tasks.
  - `tmpnam()` may produce identical file names across tasks and should be restricted to being invoked from a single task (subtask or main task).
  - `rand()/srand()` produce entirely independent series of pseudorandom integers on each task
  - All file manipulation functions (such as `fopen()/fread()/...`) - were identified earlier under the rules for parallel functions in “Designing and coding applications for MTF” on page 863. These functions can only be used on the same task.

**Note:** When opening files under MTF, you incur additional overhead when `fopen()` and `freopen()` are called. This overhead would normally be performed at the first read or write to the stream and will not affect the performance of a program that does indeed perform at least one read or write to the stream.

- `fetch()/release()` must only be issued from the same task.
- `free()` must be issued on the same task as the `malloc()/calloc()/realloc()` functions were issued. Note also that a `realloc()` must be issued in the same task as the `malloc()`.
- `signal()/raise()` also identified earlier under the rules for parallel functions in “Designing and coding applications for MTF” on page 863. Basically, each task has its own distinct interrupt environment. Thus `signal()/raise()` issued from one task have no effect on the operation of any other task.
- PL/I and COBOL interlanguage calls must not be made from parallel functions.
- Busy waits (loops that iterate until a flag is changed by a cooperating task) violate the requirement for computational independence. In particular, they can result in deadlock because of the scheduling algorithm used by MVS. They must be avoided.

---

## Part 7. Programming with Other Products

This part contains the following programming product information:

- Chapter 52, "Using the CICS Transaction Server (CICS TS)," on page 879
- Chapter 53, "Using Cross System Product (CSP)," on page 905
- Chapter 54, "Using Data Window Services (DWS)," on page 919
- Chapter 55, "Using DB2 Universal Database," on page 921
- Chapter 56, "Using Graphical Data Display Manager (GDDM)," on page 929
- Chapter 57, "Using the Information Management System (IMS)," on page 935
- Chapter 58, "Using the Query Management Facility (QMF)," on page 943





---

## Chapter 52. Using the CICS Transaction Server (CICS TS)

This chapter describes how to develop XL C/C++ programs for the CICS Transaction Server for z/OS (CICS TS). You can find more information about the general features of z/OS Language Environment and CICS in *z/OS Language Environment Programming Guide*.

For information on using CSP/AD or CSP/AE under CICS, see Chapter 53, “Using Cross System Product (CSP),” on page 905.

### Notes:

1. AMODE 64 applications are not supported in a CICS TS environment.
2. As of this publication, the standalone CICS translator does not recognize the C compiler's support for alternative locales and coded character sets. Therefore, you should write all your CICS C code in coded character set IBM-1047 (APL 293).
3. XPLINK applications are not supported under CICS prior to CICS TS 3.1.
4. As of V1R2, a non-XPLINK Standard C++ Library DLL allows support for the Standard C++ Library in the CICS subsystem. For further information, see "Binding z/OS C/C++ Programs" in *z/OS XL C/C++ User's Guide*.

---

### Developing XL C/C++ programs for the CICS environment

When developing a program to run under CICS TS you must complete all of the following actions:

1. Prepare CICS for use with z/OS Language Environment.
2. Design and code the CICS program.
3. Translate and compile the translated source for reentrancy.
4. Prelink and link all object modules with the CICS stub.
5. Define the program to CICS.

---

### Preparing CICS for use with z/OS Language Environment

This section gives general instructions on enabling z/OS Language Environment to use a new CICS TS environment or to add z/OS Language Environment to an existing CICS TS environment. For more detailed information on CICS TS, refer to the CICS documentation, which is available at:

<http://www-01.ibm.com/software/hcp/cics/cics-library/>

After CICS TS has been installed on your system, you must perform the following tasks:

- Create a CICS TS environment if one does not already exist. This involves creating a CICS System Definition (CSD), journals, and a Global Catalog Set (GCD).
- Copy CEECCICS from SCEERUN to an Authorized Program Facility (APF) data set. The data set should be concatenated in the STEPLIB when CICS is cold started.
- Create the CES0 and CESE Transient Data Queues. Sample Destination Control Table (DCT) definitions are supplied in SCEESAMP (CEECDCT).

- Add required definitions to the CSD. Sample CSD definitions are provided in SCEESAMP(CEECCSD). These sample definitions create a group called CEE, which must be added to the installation LIST.
- Add SCEERUN and SCEECICS to the DFHRPL concatenation.

The C runtime event handler module CEEEV003 is required for CICS TS support (in addition to the z/OS Language Environment interface modules). CEEEV003 must be link-edited as AMODE=31, RMODE=ANY, and loaded above the 16M line.

If you will be using the I/O stream library, complex mathematics, collection, or Application Support Class DLLs provided with the z/OS XL C++ compiler, you must define these DLLs in the CSD, and the CBC.SCLBDLL library must be added to the DFHRPL concatenation. Sample CICS CSD definitions can be found in CBC.SCLBJCL(CLB3YCSD).

---

## Designing and coding for CICS

This section describes what you must do differently when designing and coding a z/OS XL C/C++ program for CICS TS, such as using EXEC CICS commands in your code, using input and output, using z/OS XL C/C++ functions, managing storage, using interlanguage calls, and exception handling.

### Using the CICS command-level interface

CICS TS provides a set of commands to access the CICS transaction server. The format of a CICS command is:

```
EXEC CICS function [option[(arg)]]...;
```

In the following CICS command, the function is SEND TEXT. This function has 4 options: FROM, LENGTH, RESP and RESP2. In this case, each of the options takes one argument.

```
EXEC CICS SEND TEXT FROM(mymsg)
                    LENGTH(mymsglen)
                    RESP(myresp)
                    RESP2(myresp2);
```

For further information on the EXEC CICS interface and a list of available CICS TS functions, refer to CICS documentation, which is available at:

<http://www-01.ibm.com/software/htp/cics/cics-library/>

When you are designing and coding your CICS TS application, remember the following:

- The EXEC CICS command and options should be in uppercase. The arguments follow general C or C++ conventions.
- Before any EXEC CICS command is issued, the EXEC Interface Block (EIB) must be addressed by the EXEC CICS ADDRESS EIB command.
- z/OS XL C/C++ does not support the use of EXEC CICS commands in macros.

The example program in Figure 217 on page 882 (CCNGCI1) shows the use of several EXEC CICS commands to perform various tasks.

#### **1** Initialize the CICS interface

- 2** Access the storage passed from the caller
- 3** Handle unexpected abends
- 4** and **7**  
I/O to RRDS files
- 5** and **6**  
Requesting and formatting time

```

/* program : GETSTAT          */

#include <stdio.h>
#include <string.h>
#include <stdlib.h>

#define FILE_LEN 40

void check_4_down_status( char *status_record ) ;
void sendmsg( char* status_record ) ;
void unexpected_prob( char* desc, int rc ) ;

struct com_struct {
    unsigned int quiet ;
} *commarea ;

DFHEIBLK *dfheiptr ;

main ()
{
    long int vsamrrn;
    signed short int vsamlen;
    unsigned char status_record[41];
    signed long int myresp;
    signed long int myresp2;

                                /* get addressability to the EIB first */
EXEC CICS ADDRESS EIB(dfheiptr);      1

                                /* access common area sent from caller */
EXEC CICS ADDRESS COMMAREA(commarea);  2

                                /* call the CATCHIT prog. if it abends */
EXEC CICS HANDLE ABEND PROGRAM("CATCHIT ");  3

    vsamrrn = 1;
    vsamlen = FILE_LEN;

                                /* read the status record from the file*/
EXEC CICS READ FILE("STATFILE")      4
        UPDATE
        INTO(status_record)
        RIDFLD(vsamrrn)
        RRN
        LENGTH(vsamlen)
        RESP(myresp)
        RESP2(myresp2);
                                /* check cics response          */
                                /*      -- non 0 implies a problem */
    if (myresp != DFHRESP(NORMAL))
        unexpected_prob("Unable to read from file",61);

    printf("The status_record from READ in GETSTAT = %s\n", status_record);

    if (memcmp(status_record,"DOWNTME ",8) == 0)
        check_4_down_status(status_record);

    if (commarea->quiet != 1)
        sendmsg(status_record);

    exit(11);
}

```

*Example illustrating how to use EXEC CICS commands (Part 1 of 3)*

*Figure 217. Example illustrating how to use EXEC CICS commands*

```

void check_4_down_status( char *status_record )
{
    unsigned char uptime[9];
    unsigned char update[9];
    char curabs[8];
    unsigned char curtime[9];
    unsigned char curdate[9];

    long int vsmrrn;
    signed short int vsmlen;
    signed long int dnresp;
    signed long int dnresp2;

    strncpy((status_record+8),update,8);
    strncpy((status_record+16),uptime,8);
    update[8] = '\0';
    uptime[8] = '\0';

    /* get the current time/date */
    EXEC CICS ASKTIME ABSTIME(curabs)      5
        RESP(dnresp)
        RESP2(dnresp2);

    if (dnresp != DFHRESP(NORMAL))
        unexpected_prob("Unexpected prob with ASKTIME",dnresp);

    /* format current date to YYMMDD */
    /* format current time to HHMMSS */
    EXEC CICS FORMATTIME ABSTIME(curabs)   6
        YYMMDD(curdate)
        TIME(curtime)
        TIMESEP
        DATESEP;

    if (dnresp != DFHRESP(NORMAL))
        unexpected_prob("Unexpected prob with FORMATTIME",dnresp);

    curdate[8] = '\0';
    curtime[8] = '\0';

    if ((atoi(curdate) > atoi(update)) ||
        (atoi(curdate) == atoi(update) && atoi(curtime) >= atoi(uptime)))
    {
        strcpy(status_record,"OK");

        vsmrrn = 1;
        vsmlen = FILE_LEN;

        /* update the first record to OK */
        EXEC CICS REWRITE FILE("STATFILE") 7
            FROM(status_record)
            LENGTH(vsmlen)
            RESP(dnresp)
            RESP2(dnresp2);

        if (dnresp != DFHRESP(NORMAL)) {
            printf("The dnresp from REWRITE = %d\n", dnresp) ;
            printf("The dnresp2 from REWRITE = %d\n", dnresp2) ;
            unexpected_prob("Unexpected prob with WRITE",dnresp);
        }
    }
}

```

*Example illustrating how to use EXEC CICS commands (Part 2 of 3)*

```

        printf("%s %s Changed status from DOWNTME to OK\n",curdate,
               curtime);
    }
}

void sendmsg( char* status_record )
{
    long int msgresp, msgresp2;
    char outmsg[80];
    int outlen;

    if (memcmp(status_record,"OK ",3)==0)
        strcpy(outmsg,"The system is available.");
    else if (memcmp(status_record,"DOWNTME ",8)==0)
        strcpy(outmsg,"The system is down for regular backups.");
    else
        strcpy(outmsg,"SYSTEM PROBLEM -- call help line for details.");

    printf("%s\n",outmsg);
    outlen=strlen(outmsg);

    EXEC CICS SEND TEXT FROM(outmsg)
                LENGTH(outlen)
                RESP(msgresp)
                RESP2(msgresp2);

    if (msgresp != DFHRESP(NORMAL))
        unexpected_prob("Message output failed from sendmsg",71);
}

void unexpected_prob( char* desc, int rc)
{
    long int msgresp, msgresp2;
    int msglen;

    msglen = strlen(desc);

    EXEC CICS SEND TEXT FROM(desc)
                LENGTH(msglen)
                RESP(msgresp)
                RESP2(msgresp2);

    fprintf(stderr,"%s\n",desc);

    if (msgresp != DFHRESP(NORMAL))
        exit(99);
    else
        exit(rc);}

```

*Example illustrating how to use EXEC CICS commands (Part 3 of 3)*

## Using input and output

This section describes how to use z/OS XL C/C++ I/O with CICS TS. It describes the file and device support and the type of I/O used with CICS TS.

**Note:** You can set up a SIGIOERR handler to catch read or write system errors. See Chapter 18, “Debugging I/O programs,” on page 223 for more information.

### Standard stream support

Under CICS, if you are using the z/OS XL C++ standard streams, note the following:

- cin is not supported under CICS.

- cout maps to the Standard C I/O stream stdout.
- cerr and clog both map to the C standard stream stderr.

stdout and stderr are assigned to transient data destinations (queues). The type of queue, intrapartition or extrapartition, is determined during CICS initialization. Intrapartition queues are used for queueing messages and data within a CICS region. Extrapartition queues are used to send data outside the CICS region or to receive data from outside the CICS region.

The transient data queues associated with stdout and stderr are CES0 and CESE respectively. z/OS XL C/C++ supports VA and VBA queues with an lrecl of at least 137 bytes.

Records sent to the transient data queues associated with stdout and stderr take the form of a message. The entire message record can be preceded by an ASA Standard control character. Figure 218 illustrates the recommended message format.

ASA	terminal id	transaction id	sp	Time Stamp YYYYMMDDHHMMSS	sp	data
1	4	4	1	14	1	108

Figure 218. Format of data written to a CICS data queue

**ASA** is the carriage-control character.

**terminal id**

is a 4-character terminal identifier.

**transaction id**

4-character transaction identifier

**sp** a space

**Time Stamp**

date and time displayed in the format YYYYMMDDHHMMSS

**data** data that is output to the standard streams stdout and stderr

The following are sample messages of data written to a CICS data queue:

```
SAMATST1 19940401080523 Hello World - from transaction TST1!
BOBATST3 19940401112348 Hello World - from transaction TST3!
TEDATST2 19940401112348 Hello World - from transaction TST2!
```

Standard streams can only be redirected to, or from, memory files. Because only one transient data queue can be associated with each of stdout and stderr, these queues can contain output written in chronological order from many C and C++ programs. This output must be sorted as necessary into the desired sequence.

**Full memory file support**

The full set of C I/O library functions is supported under CICS TS for memory files. Memory files are created with the parameter type set to memory on the fopen() call. If you are using C++, you can also use the I/O stream library to create and access memory files. Hiperspace memory files are not supported.



## Support for disk files and other devices

There is no support by the C I/O library or the I/O stream library for using disk files and other devices with CICS TS. I/O to access methods supported by CICS TS must use the CICS TS Application Programming Interface.

## Using z/OS XL C/C++ library support

This section discusses restrictions and support for the z/OS XL C/C++ library with CICS.

### Arguments to C or main()

When a z/OS XL C/C++ program is running under CICS TS, you cannot pass command line arguments to it. The values for `argc` and `argv` have the following settings:

```
argc    1
argv[0]
```

4-character CICS transaction ID

### Runtime options

Command line runtime options cannot be passed in CICS. To specify runtime options in XL C/C++, you must include the `#pragma runopts` directive in the code. Figure 217 on page 882 shows how to do this. See *z/OS Language Environment Programming Guide* for information on other ways to supply runtime options when you are running under CICS TS.

### Using packed decimal with CICS

The packed decimal data type is supported under CICS TS. However, the standalone CICS translator does not support packed decimal. CICS expects packed decimal streams to be passed to it as arrays of characters. If you want to manipulate these arrays as a packed decimal number, you should define the array of characters in union with the appropriate packed decimal definition. For information about how to define the data fields for the EXEC CICS commands you are using, refer to CICS documentation, which is available at:

<http://www-01.ibm.com/software/http/cics/cics-library/>

**Note:** The z/OS XL C++ compiler does not support packed decimal data. Any program using the C or C++ character data type to handle packed decimal data must have its own functions for the manipulation of this data.

### Locales

All locale functions are supported for locales that have been defined in the CSD. CSD definitions for the IBM-supplied locales are provided in `SCEESAMP(CEECCSD)`. `setlocale()` returns NULL if the locales are not defined.

### Code set conversion tables

The code set conversion tables that are used by the `iconv()` functions must be defined in the CSD.

### POSIX

There is no support for POSIX functions that are not already defined as part of ANSI/ISO. z/OS UNIX is not supported under CICS.

### Multitasking facility

MTF functions are not supported under CICS TS.

### System programming C facilities

There is no support for the System Programming C facilities (SP C) under CICS TS.

## SVC99 and dynamic allocation functions

`svc99()` and the dynamic allocation functions `dynalloc()`, `dynfree()`, and `dyninit()` are not supported under CICS TS. The `svc99()` function returns 0 if the input is NULL, otherwise the return value is undefined.

## IMS

There is no support for the `ctdli()` function under CICS TS. If you call `ctdli()` under CICS TS, the return value is -1. For information about the CICS TS method to access IMS, refer the CICS documentation at:

<http://www-01.ibm.com/software/htp/cics/cics-library/>

## Dump functions

The dump functions `csnap()`, `cdump()`, and `ctrace()` are supported under CICS TS. The output is sent to the CESE transient data queue. The dump can not be written if the queue does not have a sufficient LRECL. An LRECL of at least 161 is recommended.

## Dynamic Linked Libraries (DLL)

All DLLs must be defined in the CSD.

## fetch()

The `fetch()` function is supported under CICS TS. Modules to be fetched must be defined to the CSD and installed in the PPT.

## release()

The `release()` function is supported under CICS TS.

## system()

The `system()` function is not supported under CICS TS. However, there are two EXEC CICS commands that give you similar functionality:

### EXEC CICS LINK

This command enables you to transfer control to another program and return to the calling program later. See Figure 219 on page 891.

### EXEC CICS XCTL

This command enables you to transfer control to another program. Control does not return to the caller after completion of the called program.

## Time functions

All time functions are supported except the `clock()` function, which returns the value `(time_t)(-1)` if it is used under CICS TS.

## iscics()

The `iscics()` function is an extension to the C library. It returns a non-zero value if your program is currently running under CICS. If your program is not running under CICS, `iscics()` returns the value 0. The following example shows how to use `iscics()` in your C or C++ program to specify non-CICS or CICS specific behavior.

```
if (iscics() == 0)
    <non-CICS behavior>
else
    <CICS-specific behavior>
```

## Floating point arithmetic

The simulation of extended precision floating point is not supported in CICS TS.

## Program termination

A C or C++ program running under CICS will terminate when:

- An `exit()` function call or a return statement is issued in the C or C++ program. The `atexit()` list of functions is run when the C or C++ program terminates.

**Note:** On return from a C or C++ application, the return statement or values passed by C or C++ through the `exit()` function are saved in the EIBRESP2 field of the EIB.

- An abend occurs and is not handled.
- An EXEC CICS RETURN is issued in your C or C++ program. The `atexit()` list of functions runs after these calls.
- The `abort()` function is started.

## Storage management

A z/OS XL C/C++ program can acquire storage from and release storage to CICS TS either implicitly or explicitly.

Storage is acquired and released *implicitly* by the runtime environment. This storage is used for automatic, external, and static variables. External variables are valid until program completion.

Storage is acquired and released *explicitly* by the user with the C library functions `malloc()`, `calloc()`, `realloc()`, or `free()`, with z/OS Language Environment Callable Services (refer to *z/OS Language Environment Programming Guide*), with the C++ `new` and `delete` operators, or with the EXEC CICS commands EXEC CICS GETMAIN, or EXEC CICS FREEMAIN.

- If you request the storage by using the C functions `malloc()`, `realloc()`, or `calloc()` you must deallocate it by using C functions as well.
- If you request the storage by using z/OS Language Environment Callable Services, you must deallocate it by using z/OS Language Environment Callable Services.
- If you request the storage by using EXEC CICS GETMAIN, you must deallocate it by using EXEC CICS FREEMAIN.
- If you request storage using the C++ `new` operator, you must deallocate it by using the C++ `delete` operator.

All other combinations of methods of requesting and deallocating storage are unsupported and lead to unpredictable behavior.

Partial deallocations are not supported. All storage allocated at a given time must be deallocated at the same time.

Under the z/OS Language Environment library, z/OS XL C/C++ uses the z/OS Language Environment Callable Services to allocate and free storage. Refer to *z/OS Language Environment Programming Guide* for specific information on memory and storage manipulation in CICS.

The z/OS XL C/C++ library functions acquire all storage from the Extended Dynamic Storage Area (EDSA) unless you specify otherwise using the ANYHEAP, BELOWHEAP, HEAP, STACK, or LIBSTACK runtime options.

Storage that is acquired with the EXEC CICS GETMAIN command exists for the duration of the CICS task.

If your application is multi-threaded or often uses `malloc()`, `realloc()`, `calloc()`, and `free()`, you should consider using the HEAPPOOLS runtime option. Although storage requirements may increase, you can expect better performance.

## Using ILC support

The z/OS Language Environment library supports a variety of different types of interlanguage calls (ILC) with CICS TS. For information on supported configurations, please refer to *z/OS V2R1.0 Language Environment Writing Interlanguage Communication Applications*.

## Exception handling

You can use three different kinds of exception handlers when running C programs in a CICS TS environment: CICS exception handlers, z/OS Language Environment abend handlers, and C exception handlers. If you are using C++, you can use any of these three, or the C++ exception handling approach using `try`, `throw`, and `catch`. When a CICS condition is not handled under C++, the behavior of constructors and destructors for objects is undefined.

If the CICS command EXEC CICS HANDLE ABEND PROGRAM(*name*) was specified in the application, it will be called for any program exception that occurs (such as an operation exception or a protection exception) as well as for any EXEC CICS ABEND ABCODE(...) command that is run.

z/OS Language Environment provides facilities to set up a user handler. These facilities are discussed in detail in *z/OS Language Environment Programming Guide*.

In CICS TS, the C error handling facilities have almost the same behavior as discussed in Chapter 28, "Handling error conditions, exceptions, and signals," on page 403. A signal raised with the `raise()` function is handled by its corresponding signal handler or the default actions if no handler is installed. If a program exception such as a protection exception occurs, it is handled by the appropriate C handler if no CICS or z/OS Language Environment handler is present.

When a C or C++ application is invoked by an EXEC CICS LINK PROGRAM(...), the invoked program inherits any handlers registered by EXEC CICS HANDLE ABEND PROGRAM(...) in the parent program. Any handlers registered in the child override the inherited handlers. C signal handlers are **not** inherited.

The following chart shows the process for handling abends in CICS TS.

### Error handling in CICS Procedure

1. Is this the result of a call to `raise()`?

Option	Description
Yes	See 2
No	See 9 on page 890

2. Is SIG\_IGN set for the signal?

Option	Description
Yes	See 3
No	See 4

3.
  - a. Resume at the next instruction.
4. Is z/OS Language Environment handler registered?

Option	Description
Yes	See 5
No	See 6

5.
  - a. Run z/OS Language Environment user handler. See *z/OS Language Environment Programming Guide* for more details.
6. Is a C or C++ handler established?

Option	Description
Yes	See 7
No	See 8

7.
  - a. Run C or C++ handler.
8.
  - a. Default handling the program check and percolate to next stack frame.
9. Has EXEC CICS HANDLE ABEND been issued?

Option	Description
Yes	See 10
No	See 11

10.
  - a. Call z/OS XL C/C++-CICS interface for termination of program. CICS turns off signal and runs program in handler.
11.
  - a. Continue at Step 005.

## Example of error handling in CICS

The example program in Figure 219 on page 891 (CCNGCI2) shows how to handle errors when using z/OS XL C/C++ with CICS.

```

/* program :   CHKSTAT                               */
/* transaction : called stand alone from transaction CHST */
/*           is also used by other transactions to determine */
/*           system status                                   */

#include <stdio.h>
#include <string.h>
#include <stdlib.h>
#include <signal.h>

#define FILE_LEN 40

void status_not_ok(int sig);
void unexpected_prob(char* desc, int rc);
volatile unsigned char status_record [41];

struct com_struct {
    int quiet;
} com_reg;

main (int argc, char *argv [ ])
{
    long int vsamrrn;
    signed short int vsamlen;

    signed long int myresp;
    signed long int myresp2;
    unsigned char status_downtme [41];

    if (strcmp(argv[0],"CHST") !=0) {
        printf("argv[0] = %s\n", argv[0]);
        com_reg.quiet = 1;
    }
    else
        com_reg.quiet = 0;
}

```

*Example illustrating error handling under CICS (Part 1 of 3)*

*Figure 219. Example illustrating error handling under CICS*

```

/* get addressability to the EIB first */
EXEC CICS ADDRESS EIB(dfheiptr);

EXEC CICS HANDLE ABEND PROGRAM("CATCHIT ");           1
signal(SIGUSR1,status_not_ok);                        2

EXEC CICS LINK PROGRAM("GETSTAT ")                   3
      RESP(myresp)
      RESP2(myresp2)
      COMMAREA(&com_reg)
      LENGTH(4);

/* check for failure in linked-to program */
if (myresp != DFHRESP(NORMAL)) {
    printf("The RESP of LINK = %d\n", myresp);
    printf("The RESP2 of LINK = %d\n", myresp2);
    unexpected_prob("CICS failure on EXEC CICS LINK\n",51);
}

if (myresp2 != 11)
    unexpected_prob("Unexpected rc from GETSTAT\n",myresp2);

vsamrrn = 1;
vsamlen = FILE_LEN;

/* following READ for UPDATE is for test purpose only. */
EXEC CICS READ FILE("STATFILE")
      UPDATE
      INTO(status_record)
      RIDFLD(vsamrrn)
      RRN
      LENGTH(vsamlen)
      RESP(myresp)
      RESP2(myresp2);

/* check for cics response - non-0 implies problem */
if (myresp != DFHRESP(NORMAL))
    unexpected_prob("Unable to read from file",52);

```

*Example illustrating error handling under CICS (Part 2 of 3)*

```

/* write DOWNTME back to file - for test purpose only */
strcpy(status_downtme,"DOWNTME");
EXEC CICS REWRITE FILE("STATFILE")
        FROM(status_downtme)
        LENGTH(vsamLen)
        RESP(myresp)
        RESP2(myresp2);

if (myresp != DFHRESP(NORMAL)) {
    printf("The dnresp from REWRITE = %d\n", myresp);
    printf("The dnresp2 from REWRITE = %d\n", myresp2);
    unexpected_prob("Unexpected prob with WRITE",myresp);
}

if (memcmp(status_record,"OK ",3) != 0)
    raise(SIGUSR1);

exit(11);
}

void unexpected_prob( char* desc, int rc)
{
    long int msgresp, msgresp2;
    int msglen;

    msglen = strlen(desc);

    EXEC CICS SEND TEXT FROM(desc)
            LENGTH(msglen)
            RESP(msgresp)
            RESP2(msgresp2);

    fprintf(stderr,"%s\n",desc);

    if (msgresp != DFHRESP(NORMAL))
        exit(99);
    else
        exit(rc);
}

void status_not_ok( int sig )      4
{
    if (memcmp(status_record,"DOWNSTR ",8) != 0)
        exit(22);
    else
        exit(33);
}

```

*Example illustrating error handling under CICS (Part 3 of 3)*

- 1** The program CATCHIT has been installed as the CICS abend handler. Because this CICS abend handler is installed, C exception handlers will only catch signals raised with the raise() function.
- 2** Install a C signal handler to catch the user defined signal SIGUSR1. This handler will only be called if raise(SIGUSR1) is run.
- 3** This command causes the flow of control to shift to a child program called GETSTAT. GETSTAT will inherit CHKSTAT's CICS abend handler.
- 4** The C signal handler status\_not\_OK that was will be invoked if this line is run. The raise() function will **not** trigger the CICS abend handler.



## ABEND codes and error messages under z/OS XL C/C++

For information on ABEND Codes and error messages used by the z/OS Language Environment library, refer to *z/OS Language Environment Programming Guide* and *z/OS Language Environment Debugging Guide*.

### Coding hints and tips

- Do not use EXEC CICS commands in macros.
- Do not use EXEC CICS commands in header files. This makes the translation process much simpler.
- Do not set `atexit()` routines before an EXEC CICS XCTL. You will get unpredictable results.
- If you call `fclose()` or `freopen()` for a standard stream, you cannot redirect or reopen the link to the transient data queue. z/OS XL C/C++ does not provide a method of opening or reopening the transient data queues.
- The actual transient data queue is not closed when you call `fclose()` or `freopen()` for a standard stream; however, the transaction will lose access to the stream.
- You should not use the `stdin` stream unless you are redirecting it from a memory file.
- Closing the `cout`, `cerr`, or `clog` standard streams in a C++ application has the same effect as closing `stdout` or `stderr`.
- When CICS handlers (using EXEC CICS HANDLE ABEND PROG) are activated along with C or C++ signal handlers, the CICS handler is invoked when an abend occurs. The C or C++ signal handler that corresponds to that class of abends is ignored.

**Note:** The handler mentioned here is not a catch clause. It is a C signal handler exception registered by a C++ routine.

- If you do an EXEC CICS RETURN out of an `atexit()` routine, the resulting return code (RESP2) is undefined.

---

## Translating and compiling for reentrancy

This section discusses translation of embedded CICS statements and provides examples. It also discusses reentrancy issues with respect to CICS.

### Options for translating CICS statements

There are two options for translating CICS statements into C or C++ code: The z/OS XL C/C++ integrated CICS translator and the standalone CICS translator, a CICS TS utility.

#### z/OS XL C/C++ integrated CICS translator

If you are using CICS Transaction Server 3.1 or later, you can compile XL C/C++ source code with embedded CICS commands and keywords without using the CICS TS language translation utility if you use the CICS compiler option. You can embed comments and macros within the embedded CICS commands.

When you use the z/OS XL C/C++ integrated CICS translator, you might experience the following benefits:

- More seamless operation of C/C++ applications that run in the CICS environment, especially under UNIX System Services
- Improved program readability

- Easier application maintenance
- Tighter coupling between the translation and compilation phases
- A more unified development approach across z/OS XL C, z/OS XL C++, COBOL, and PL/I

For more information, refer to the CICS compiler option in *z/OS XL C/C++ User's Guide*.

In general, source code that can be processed successfully by the standalone CICS translator will be compatible with the integrated CICS translator.

**Exception:** The standalone CICS translator does not recognize C/C++ macros. For this reason, a CICS command that is processed with the integrated CICS translator can either fail to translate or change semantically if it (coincidentally) contains an identifier that is identical to a macro that is active within the scope of the CICS command.

### Standalone CICS translator

The CICS TS utility called the CICS language translator is still supported. This program translates the EXEC CICS statements into C or C++ code. In this document, the CICS language translator is referred to as the *standalone CICS translator*.

**Note:** If you are using C++, you must use the CPP translator option to indicate to the compiler that you are using the C++ language, rather than the C language. The use of the CPP parameter specifies that the translator is to translate z/OS XL C++ programs. Code translated without the CPP option or with a translator released before version 4.1 of CICS is not supported by the z/OS XL C++ compiler and will not compile.

The standalone CICS translator supplies a control block (DFHEIBLK) for passing information between CICS TS and the application program. C or C++ function references for the EXEC CICS commands are generated. The translation step is not required if you do not use EXEC CICS statements.

The standalone CICS translator does not evaluate preprocessor directives such as **#include** or **#define**. You should ensure that all EXEC CICS statements are translated.

### Translating example

The samples in this section are valid for both the integrated CICS translator and the standalone CICS translator. Figure 220 on page 896 (CCNGCI3) shows pieces of C and C++ code before they are translated with the standalone CICS translator. Figure 221 on page 897 shows the corresponding programs after translation.

---

```

/* program : CATCHIT */

#include <stdio.h>
#include <string.h>
#include <stdlib.h>

struct com_struct {
    unsigned int quiet ;
} *commarea ;

main () {

    signed long int myresp;
    signed long int myresp2;

                                /* get addressability to the EIB first */
EXEC CICS ADDRESS EIB(dfheiptr); 1

                                /* access common area sent from caller */
EXEC CICS ADDRESS COMMAREA(commarea); 2

    printf("The program is now inside CATCHIT.\n");

    /* statements required to handle the abend
EXEC CICS .....
EXEC CICS ..... */

    EXEC CICS RETURN;

}

```

---

*Figure 220. Example illustrating how to use EXEC CICS commands*

**1** and **2**

These programs each contain two EXEC CICS commands to be translated by the standalone CICS translator. A single instance of the EXEC CICS ADDRESS EIB command is required before any other call to the EXEC CICS interface. In this case, the main program (see Figure 217 on page 882) issues the ADDRESS EIB command. Since the two pieces of code make up one program there is no need to ADDRESS the EIB again.

Figure 221 on page 897 shows how the programs appear after they are translated.

```

#ifndef __dfheitab
#define __dfheitab 1
    char *dfhldver = "LD TABLE DFHEITAB 320." ;
    unsigned short int dfheib0 = 0 ;
    char *dfheid0 = "\x00\x00\x00\x0c" ;
    char *dfheicb = " " ;
    typedef struct {
        unsigned char eibtime [4] ;
        unsigned char eibdate [4] ;
        unsigned char eibtrnid [4] ;
        unsigned char eibtasn [4] ;
        unsigned char eibtrmid [4] ;
        signed short int eibfil01 ;
        signed short int eibcposn ;
        signed short int eibcalen ;
        unsigned char eibaid ;
        unsigned char eibfn [2] ;
        unsigned char eibrcode [6] ;
        unsigned char eibds [8] ;
        unsigned char eibreqid [8] ;
        unsigned char eibrsrce [8] ;
        unsigned char eibsync ;
        unsigned char eibfree ;
        unsigned char eibrecv ;
        unsigned char eibfil02 ;
        unsigned char eibatt ;
        unsigned char eibeoc ;
        unsigned char eibfmh ;
        unsigned char eibcompl ;
        unsigned char eibsig ;
        unsigned char eibconf ;
        unsigned char eiberr ;
        unsigned char eiberrcd [4] ;
        unsigned char eibsynrb ;
        unsigned char eibnodat ;
        signed long int eibresp ;
        signed long int eibresp2 ;
        unsigned char eibrldbk ;
    } DFHEIBLK;
    DFHEIBLK *dfheiptr;
#endif

#ifndef __dfhtemps
#pragma linkage(dfhexec,OS) /* force OS linkage */
void dfhexec(); /* Function to call CICS */
#define __dfhtemps 1
    signed short int dfhb0020, *dfhbp020 = &dfhb0020 ;
    signed short int dfhb0021, *dfhbp021 = &dfhb0021 ;
    signed short int dfhb0022, *dfhbp022 = &dfhb0022 ;
    signed short int dfhb0023, *dfhbp023 = &dfhb0023 ;
    signed short int dfhb0024, *dfhbp024 = &dfhb0024 ;
    signed short int dfhb0025, *dfhbp025 = &dfhb0025 ;
    unsigned char dfhc0010, *dfhcp010 = &dfhc0010 ;
    unsigned char dfhc0011, *dfhcp011 = &dfhc0011 ;
    signed short int dfhdummy;
#endif

```

*Child C program after translation (Part 1 of 3)*

*Figure 221. Child C program after translation*

```

/* this is an example of a CICS program for C                                     */
/* program : GETSTAT ( part 2 - infrequent use routines )                       */

#include <stdio.h>
#include <string.h>
#include <stdlib.h>

void unexpected_prob( char* desc, int rc);

void sendmsg( char* status_record )
{
    long int msgresp, msgresp2;
    char outmsg[80];
    int outlen;

    if (memcmp(status_record,"OK ",3)==0)
        strcpy(outmsg,"The system is available.");
    else if (memcmp(status_record,"DOWNTIME ",8)==0)
        strcpy(outmsg,"The system is down for regular backups.");
    else
        strcpy(outmsg,"SYSTEM PROBLEM -- call help line for details.");

    outlen=strlen(outmsg);

    /* EXEC CICS SEND TEXT FROM(outmsg)                                         4
        LENGTH(outlen)
        RESP(msgresp)
        RESP2(msgresp2) */

    {
        dfhb0020 = outlen;
        dfhexec("\x18\x06\x60\x00\x2F\x00\x00\x00\x00\x00\x20\x04\x00\x00\x20\xF0\xF0\
\xF0\xF0\xF2\xF2\xF0\xF0",dfhdummy,outmsg,dfhbp020 ); 5
        msgresp = dfheiptr->eibresp;
        msgresp2 = dfheiptr->eibresp2;
    }

    if (msgresp != 0 )
        unexpected_prob("Message output failed from sendmsg",71);
}

void unexpected_prob( char* desc, int rc)
{
    long int msgresp, msgresp2;
    int msglen;

    msglen = strlen(desc);

    /* EXEC CICS SEND TEXT FROM(desc)
        LENGTH(msglen)
        RESP(msgresp)
        RESP2(msgresp2) */

```

*Child C program after translation (Part 2 of 3)*

```

    {
        dfhb0020 = msglen;
        dfhexec("\x18\x06\x60\x00\x2F\x00\x00\x00\x00\x20\x04\x00\x00\x20\xF0\xF0\
\xF0\xF0\xF4\xF1\xF0\xF0", dfhdummy, desc, dfhbp020 ); 6
        msgresp = dfheiptr->eibresp;
        msgresp2 = dfheiptr->eibresp2;
    }

    fprintf(stderr, "%s\n", desc);

    if (msgresp != 0)
        exit(99);
    else
        exit(rc);
}

```

*Child C program after translation (Part 3 of 3)*

- 3** This structure, DFHEIBLK, is used for passing information between CICS and the application program.
- 4** This is the CICS command that was interpreted by the translator. The translator comments out the EXEC CICS commands.
- 5** The translator inserts this call to the function dfhexec and comments out the EXEC CICS commands for further processing by the z/OS XL C/C++ compiler. The values msgresp and msgresp2 are set from the values in the DFHEIBLK structure.
- 6** This EXEC CICS command is similar in format to the one discussed in **4**. However, you should note that the generated call to dfhexec is different. For this reason it is important that EXEC CICS commands are not imbedded in macros.

## Compiling XL C/C++ programs that were preprocessed by the standalone CICS translator

CICS requires that programs be reentrant at CICS entry points. If you are using C, this means:

- If your program is not naturally reentrant, you must compile with the RENT compiler option.
- If you are compiling code that was translated by the standalone CICS translator, you must compile with the RENT compiler option. The standalone CICS translator puts external writable static in the program.

For both C and C++, this means that if your program is naturally reentrant and has not been translated, you can compile and link it just as you would a non-CICS program.

### Sample JCL to translate and compile

The sample JCL in Figure 222 on page 900 shows to translate and compile C modules.

---

```

/*-----
/* Translate a C-CICS program
/*-----
/* Translate a C program for CICS
/*-----
//TRANSTEP EXEC PGM=DFHEDP1$,
//      REGION=2048K,
//      PARM='MAR(1,80,0),OM(1,80,0),NOS'
//STEPLIB DD DSN=CICS.SDFHLOAD,DISP=SHR
//SYSPRINT DD SYSOUT=*
//SYSPUNCH DD DSN=&&SYSCIN,DISP=(,PASS),UNIT=VIO,
//      DCB=BLKSIZE=400,SPACE=(400,(400,100))
//SYSIN DD DSN=MYID.CHKSTAT.C,DISP=SHR
/*-----
/* Compile the translated C source.
/*-----
//C0010308 EXEC EDCC,
//      INFILE='MYID.CHKSTAT.C',
//      OUTFILE='MYID.OBJECT(CHKSTAT),DISP=SHR',
//      CPARAM='OPT(0) NOSEQ NOMAR RENT ',
//      SYSOUT6='*'
//SYSIN DD DSN=*.TRANSTEP.SYSPUNCH,DISP=(OLD,DELETE)
//USERLIB DD DSN=MYID.MYHDR.FILES,DISP=SHR

```

---

Figure 222. JCL to translate and compile a C program

Figure 223 shows an example of JCL to translate and compile a C++ program.

---

```

/*-----
/* Translate a C++-CICS program
/*-----
/* Translate C++ program for CICS
/*-----
//TRANSTEP EXEC PGM=DFHEDP1$,
//      REGION=2048K,
//      PARM='MAR(1,80,0),OM(1,80,0),NOS,CPP'
//STEPLIB DD DSN=CICS.SDFHLOAD,DISP=SHR
//SYSPRINT DD SYSOUT=*
//SYSPUNCH DD DSN=&&SYSCIN,DISP=(,PASS),UNIT=VIO,
//      DCB=BLKSIZE=400,SPACE=(400,(400,100))
//SYSIN DD DSN=MYID.CHKSTAT.C,DISP=SHR
/*-----
/* Compile the translated C++ source.
/*-----
//C0010308 EXEC CBCC,
//      OUTFILE='MYID.OBJECT(CHKSTAT),DISP=SHR',
//      CPARAM='NOSEQ NOMAR RENT ',
//      SYSOUT6='*'
//SYSIN DD DSN=*.TRANSTEP.SYSPUNCH,DISP=(OLD,DELETE)

```

---

Figure 223. JCL to translate and compile a C++ program

---

## Prelinking and linking all object modules

If you are using C++, or if you have compiled your C source with the RENT compile-time option, you must prelink all of the object modules together. The prelinker accepts one or more object modules, combines them, and generates a single output object module which can then be linked. For more information, see *z/OS XL C/C++ User's Guide*.

When prelinking for CICS, you should expect some unresolved external references and a return code of 4. These unresolved references should be resolved at link time.

CICS provides a stub called DFHELII, which must be link-edited with the load module. For your convenience, the linkage editor commands required for CICS are provided with CICS in the DFHEILID member of the SDFHC370 data set. The DFHEILID member must be reblocked before it is passed to the linkage editor. A name card should also be passed to the linkage editor. All applications **must** run AMODE=31. It is recommended that the object module is linked with AMODE(31) and RMODE(ANY). CICS does not require any other linkage editor options.

If you are using C, and your program will reside in one of the DFHRPL libraries, you do not need to link-edit the module with the RENT option. However, if the program is to be installed in one of the link pack areas, STEPLIBs, or data sets in the system link list, you should link-edit the module with the RENT option.

Figure 224 shows an example of how to prelink and link C and C++ modules.

---

```

/*-----
/* Reblock CICS support link module
/*-----
//COPYLINK EXEC PGM=IEBGENER
//SYSUT1 DD DSN=CICS.V4R1M0.SDFHC370(DFHEILID),DISP=SHR
//SYSUT2 DD DSN=&&COPYLINK,DISP=(,PASS),
//      DCB=(RECFM=FB,LRECL=80,BLKSIZE=3200),
//      UNIT=VIO,SPACE=(400,(20,20))
//SYSPRINT DD SYSOUT=*
//SYSIN DD DUMMY
/*-----
/* Prelink and link MYMAIN with MYCICSTF and MYOTHSTF
/*-----
//P0010598 EXEC EDCLP,
//      INFILE='MYID.OBJECT(MYMAIN)',
//      OUTFILE='MYID.CICS.LOAD(MYMAIN),DISP=SHR',
//      PPARM=' NCAL ',
//      LPARM='AMODE(31),RMODE(ANY) ',
//      SYSOUT4='*'
//PLKED.SYSIN DD DATA,DLM='>'
//      INCLUDE OBJECT(MYMAIN)
//      INCLUDE OBJECT(MYCICSTF)
//      INCLUDE OBJECT(MYOTHSTF)
/>
//PLKED.SYSMOD DD DSN=&&PLNK,DISP=(,PASS),UNIT=VIO,
//      DCB=(RECFM=FB,LRECL=80,BLKSIZE=3200),
//      SPACE=(32000,(30,30))
//PLKED.OBJECT DD DSN=MYID.OBJECT,DISP=SHR
//LKED.SYSLIB DD DSN=CICS.V4R1M0.SDFHLOAD,DISP=SHR
//      DD DSN=CEE.SCEELKED,DISP=SHR
//LKED.SYSLIN DD DSN=&&COPYLINK,DISP=(SHR,DELETE)
//      DD DSN=*.PLKED.SYSMOD,DISP=(SHR,DELETE)
//      DD DDNAME=SYSIN
//LKED.SYSLMOD DD DSN=MYID.CICS.LOAD,DISP=SHR
//LKED.SYSIN DD DATA,DLM='>'
//      NAME MYMAIN(R)
/>

```

---

Figure 224. Prelinking and linking



---

## Defining and running the CICS program

This section discusses the implications of program processing, link considerations for C programs, and CSD considerations. Sample JCL to install z/OS XL C/C++ application programs is provided.

### Program processing

In a CICS environment, a single copy of a program is used by several transactions concurrently. One section of a program can process a transaction and then be suspended (usually as a result of an EXEC CICS command). Another transaction can then start or resume processing the same or any other section of the same application program. This behavior requires that the program be reentrant.

### Link considerations for C programs

If your C program will reside in one of the DFHRPL libraries, following the translate, compile, and link steps detailed earlier in this chapter is sufficient; there is no requirement to link-edit the module with the RENT linkage editor option.

However, if the program is to be installed in one of the link pack areas, STEPLIBs, or data sets in the system link list, the module should be link-edited with the RENT option.

### CSD considerations

Before you can run a program, you must define it in the CICS CSD. When defining a program to CICS, you should use LANGUAGE(LE). However, if the program is in C and does not use ILC support, you can use LANGUAGE(C).

If you use a copy of a reentrant C or C++ application program that was installed in the link pack area, you must specify USELPACOPY(YES) in the resource definition when you define the program in the CSD. You can use the CICS-supplied procedure DFYEITDL to translate, compile, prelink, and link-edit C or C++ programs. For C programs, you may have to change the compile step of this procedure. You will have to change the compile step to use it with the C++ compiler.

### Sample JCL to install z/OS XL C/C++ application programs

Figure 225 shows sample JCL to install a C or C++ application program. Your application is *anyname*; *x* can resolve to I or X.

---

```
        //jobname    JOB  accounting info,name,MSGLEVEL=1
        //          EXEC PROC=DFHEXTEL
#       //TRN.SYSIN DD      *
        #pragma XOPTS(Translator options . . .)

:
        z/OS XL C/C++ source statements

:
        /*
        //LKED.SYSIN DD      *
                   NAME    anyname(R)
        /*
        //
```

---

Figure 225. JCL to install z/OS XL C/C++ application programs





---

## Chapter 53. Using Cross System Product (CSP)

This chapter briefly describes the interface between z/OS XL C and applications generated through the Cross System Product/Application Development (CSP/AD) and the Cross System Product/Application Execution (CSP/AE) Version 3 Release 2 Modification 2 or later. CSP refers to both CSP/AD and CSP/AE.

CSP/AD is an interactive application generator that provides methods for interactively defining, testing, and generating application programs. It can aid in improving productivity in application development.

CSP/AE takes the generated program and executes it in a production environment.

### Notes:

1. XPLINK is not supported in a CSP environment.
2. AMODE 64 applications are not supported in a CSP environment.

---

## Common data types

Table 346 lists the data types common to both CSP and z/OS XL C. You must use the function `__csplist` to receive the parameter list from a CSP application. See *z/OS XL C/C++ Runtime Library Reference* for more information on this function.

Table 346. Common data types between z/OS XL C and CSP

z/OS XL C	CSP
signed short	BIN - 2 bytes
signed int/long	BIN - 4 bytes
struct	RECORD
char array(size)	Characters

---

## Passing control

You can pass control between CSP and z/OS XL C as follows:

**CALL** Calls another application or subroutine to be run. When execution is completed, control is returned to the statement following the CALL statement in the original application.

### XFER | DXFR

Transfers control and initiates execution of a CSP application or non-CSP program or transaction. The current application is terminated when the transfer statement is executed.

Under CICS, XFER is used to transfer control to another CICS transaction, while DXFR is used to transfer control to an application or program. If the target name is an application, control remains in CSP and the application is initiated immediately. If the target name is a program, CSP issues CICS XCTL to the program name.

**Note:** From a z/OS XL C program, you can pass control to a CSP application but you cannot pass control to another z/OS Language Environment-enabled language

(COBOL, PL/I) from that CSP application. Only one z/OS Language Environment-enabled language can be in the chain of calls.

---

## Running CSP under MVS

The following sections cover calling CSP applications from z/OS XL C and calling z/OS XL C from CSP.

### Calling CSP applications from z/OS XL C

To call a CSP application from z/OS XL C, you must:

1. Define the CSP program to be called one of the following:
  - DCGCALL - calling under MVS/TSO
  - DCGXFER - transferring control under MVS/TSO with OS pragma linkage
2. Fetch the program dynamically.
3. Transfer control to the program. You must pass at least one parameter when calling CSP from z/OS XL C. This is the pointer to the ALF name and application name.

#### Example programs

The following example program (CCNGCP1 in Figure 226) CALLs a CSP application in the z/OS environment. You must receive a structure.

**Note:** CSP cannot pass the DXFR statement to z/OS XL C under TSO.

```
/* this example shows how to CALL CSP from C under TSO */
/*      CALL      */
/* CCNGCP1 =====> R924A6 */
/* R924A6 is a CSP application */
```

```
#include <stdlib.h>
#include <math.h>

#pragma linkage(DCGCALL,OS)

void main(int argc , char * argv[])
{
    int ctr,base, power ;

    typedef void ASM_VOID();
    #pragma linkage (ASM_VOID,OS)
    ASM_VOID * fetch_ptr;

    int rc = 0;
    char module [ 8 ] = { "DCGCALL " } ;
    struct tag_a6progc {
        char alfx [ 8 ];
        char applx [ 8 ];
    } ;
```

*C/370 CALLing CSP under TSO (Part 1 of 2)*

*Figure 226. C/370 CALLing CSP under TSO*

```

struct tag_a6rec {
    char a6ct [ 4];
    char a6lan [ 4];
    char fil1 [ 8];          /* packed fields for PLI */
    char fil2 [ 8];          /* packed fields for PLI */
    char fil3 [ 8];          /* packed fields for PLI */
    int a6xbc;
    int a6ybc;
    int a6zbc;
};
struct {
    char s_parm [ 240];
} s_parms = {"ALF=C "};

struct tag_a6progc a6_progc = {"FZERSAM.", "R924A6 "};

_Packed struct tag_a6rec a6_rec = {"CALL" ,
                                   "C " ,
                                   "0000110C",
                                   "0000220C",
                                   "0000330C",
                                   12, 2, 0
                                   };

base = atoi(argv[1]) ;
power= atoi(argv[2]) ;

a6_rec.a6xbc = base;
a6_rec.a6ybc = power;
a6_rec.a6zbc = (int) pow((double) a6_rec.a6xbc,
                       (double) a6_rec.a6ybc);

if ((fetch_ptr = (ASM_VOID *) fetch(module)) == NULL ) {
    printf (" failed on fetch of CSP %s module \n", module);
}
else {
    fetch_ptr (&a6_progc, &a6_rec);
    rc = release((void (*)()) fetch_ptr) ;
    if ( rc != 0 ) {
        printf ("CCNGCP1: rc from release =%d\n", rc );
    }
}
}

```

*C/370 CALLing CSP under TSO (Part 2 of 2)*

Figure 227 on page 908 shows example program CCNGCP2, which uses an XFER command to transfer control to a CSP application. You must pass a structure.

```

/* this example shows how to transfer control to CSP from C under */
/* TSO, using XFER */
/*          XFER          */
/* CCNGCP2 ==> R924A5 */
/* R924A5 is a CSP application */

#include <stdlib.h>
#include <math.h>
#pragma linkage(DCGXFER,OS)

void main(int argc , char * argv[] )
{
    int ctr,base, power ;
    int rc = 0;
    char module [ 8] = {"DCGXFER " } ;

    typedef void ASM_VOID();
    #pragma linkage (ASM_VOID,OS)
    ASM_VOID * fetch_ptr;

    struct tag_a5ws {
        short length ;
        char filler [ 8];
        char a5ct [ 4];
        char a5lan [ 4];
        char fil1 [ 8]; /* packed fields for PLI */
        char fil2 [ 8]; /* packed fields for PLI */
        char fil3 [ 8]; /* packed fields for PLI */
        int a5xbc;
        int a5ybc;
        int a5zbc;
    };
    struct tag_a5progx {
        char alf_x [ 8];
        char appl_x [ 8];
    };
    struct {
        char s_parm [ 240];
    } s_parms = {"ALF=C "};
    struct tag_a5progx a5_progx = {"FZERSAM.,"R924A5 " } ;
    _Packed struct tag_a5ws a5_ws = { 54,
                                     "CCNGCP2",
                                     "XFER" ,
                                     "C " ,
                                     "0000110C",
                                     "0000220C",
                                     "0000330C",
                                     12, 2, 0
    };

    base = atoi(argv[1]) ;
    power= atoi(argv[2]) ;
    a5_ws.a5xbc = base;
    a5_ws.a5ybc = power;
    a5_ws.a5zbc = (int) pow((double) a5_ws.a5xbc,
                           (double) a5_ws.a5ybc);
    if ((fetch_ptr = (ASM_VOID *) fetch(module)) == NULL ) {
        printf (" failed on fetch of CSP %8s module \n", module);
    }
}

```

*z/OS XL C transferring control to CSP under TSO using the XFER/DXFER statement (Part 1 of 2)*

*Figure 227. z/OS XL C transferring control to CSP under TSO using the XFER/DXFER statement*

```

else {
    fetch_ptr (&a5_ws , &a5_progx);
    rc = release((void (*) ())fetch_ptr) ;
    if ( rc != 0 ) {
        printf ("CCNGCP2: rc from release =%d\n", rc );
    }
}
}
}

```

*z/OS XL C transferring control to CSP under TSO using the XFER/DXFER statement (Part 2 of 2)*

## Calling z/OS XL C from CSP

To call a z/OS XL C program from CSP:

- PLIST(OS) must be specified in the z/OS XL C program so that input parameters will not be processed by the runtime environment.
- When CSP passes a parameter list to a z/OS XL C function, the list is in a different format from what z/OS XL C expects in a normal z/OS environment. To receive the parameters, use the macro `__csplist`, found in the `csp.h` header file and described in *z/OS XL C/C++ Runtime Library Reference*.

### Notes:

1. PLIST(OS) must be specified in the z/OS XL C program so that input parameters will not be processed by the runtime environment.
2. When CSP passes a parameter list to a z/OS XL C function, the list is in a different format from what z/OS XL C expects in a normal z/OS environment. To receive the parameters, use the macro `__csplist`, found in the `csp.h` header file and described in *z/OS XL C/C++ Runtime Library Reference*.

### Example programs

Figure 228 on page 910 shows example program CCNGCP3, which shows how parameters are received from a CSP application that uses a CALL statement to transfer control. You must pass three parameters:

- An int
- A string
- A struct



---

```

/* this example shows how to CALL C from CSP under TSO */

#pragma runopts (plist(os))
#include <csp.h>
#include <math.h>
#include <stdlib.h>

void main()
{
struct date {
    char yy[2];
    char mm[2];
    char dd[2];
};
int *parm1_ptr ;
char *parm2_ptr ;
struct date * parm3_ptr ;
    parm1_ptr = (int *) __csplist[0];          /* get 1st  parm */
    parm2_ptr = (char *) __csplist[1];        /* get 2nd  parm */
    parm3_ptr = (struct date *) __csplist[2]; /* get 3rd  parm */
}

```

---

*Figure 228. CSP CALLing z/OS XL C under TSO*

Figure 229 on page 911 shows example program CCNGCP4, which shows how parameters are received from a CSP application that uses an XFER/DXFR statement to transfer control. You must pass a structure.

**Notes:**

1. Under TSO, CSP/AD cannot use the XFER statement to transfer control to z/OS XL C.
2. Under TSO, you cannot use the DXFR statement to transfer control to CSP.

```

/* this example shows how to transfer control from CSP to C          */
/*      This program will be called from CSP through                */
/*      "XFER" or DXFR call.                                        */
/*      Parameters are passed as a working storage record          */
/*      plus 10 bytes of filler information                          */
/*      2 bytes length                                             */
/*      8 bytes filler                                             */
/*      n bytes working storage record.                             */
/*                                                                    */

#pragma runopts (plist(os))
#include <stdlib.h>
#include <csp.h>
#include <math.h>
#include <string.h>

#pragma linkage(DCGXFER,OS)
#pragma linkage(DCGCALL,OS)

void xfer_rtn ();
void call_rtn ();

struct tag_a3ws {
    short length ;
    char filler [ 8];
    char a3ct [ 4];
    char a3lan [ 4];
    char fill [ 8];          /* packed fields for PLI */
    char fil2 [ 8];          /* packed fields for PLI */
    char fil3 [ 8];          /* packed fields for PLI */
    int a3xbc;
    int a3ybc;
    int a3zbc;
};
struct tag_a3progx {
    char alfx [ 8];
    char applx [ 8];
};

void main()
{
    _Packed struct tag_a3ws *parm1 ;
    _Packed struct tag_a3ws a3_ws ;

    parm1 = (_Packed struct tag_a3ws *) __csplist[0];
    parm1->a3zbc = (int) pow((double) parm1->a3xbc,
                          (double) parm1->a3ybc);

    if (parm1->a3zbc > 255)
        xfer_rtn(parm1);      /* xfer to csp */
    else
        call_rtn(parm1);     /* call to csp */
}

```

*CSP transferring control to z/OS XL C under TSO using the XFER statement (Part 1 of 3)*

*Figure 229. CSP transferring control to z/OS XL C under TSO using the XFER statement*

```

/*****
/*
*/
/*****
void xfer_rtn(_Packed struct tag_a3ws * parm1 )
{
    #pragma linkage (ASM_VOID,OS)
    typedef void ASM_VOID();
    ASM_VOID * fetch_ptr;

    struct tag_a3progx a3_progx = {"FZERSAM.,"R924A5 " } ;
    int rc = 0;
    char pgm_xfer [ 8] = {"DCGXFER " } ;

    if ((fetch_ptr = (ASM_VOID *) fetch(pgm_xfer)) == NULL ) {
        printf (" failed on fetch of CSP %8s module \n", pgm_xfer);
    }
    else {
        fetch_ptr (parm1, &a3_progx);
        rc = release((void (*)()) fetch_ptr) ;
        if ( rc != 0 ) {
            printf ("xfer_rtn: rc from release =%d\n", rc );
        }
    }
}
/*****
/*
*/
/*****
void call_rtn(_Packed struct tag_a3ws * parm1 )
{
    typedef void ASM_VOID();
    ASM_VOID * fetch_ptr;
    char pgm_call [ 8] = {"DCGCALL " } ;
    int rc = 0;
    struct tag_a3progx a3_progx = {"FZERSAM.,"R924A6 " } ;
    struct tag_a6rec {
        char a6ct [ 4];
        char a6lan [ 4];
        char fil1 [ 8]; /* packed fields for PLI */
        char fil2 [ 8]; /* packed fields for PLI */
        char fil3 [ 8]; /* packed fields for PLI */
        int a6xbc;
        int a6ybc;
        int a6zbc;
    };
    struct tag_a6rec a6_rec ;
    memcpy(a6_rec.a6ct ,parm1->a3ct ,4);
    memcpy(a6_rec.a6lan,parm1->a3lan,4);
    memcpy(a6_rec.fil1 ,parm1->fil1 ,8);
    memcpy(a6_rec.fil2 ,parm1->fil2 ,8);
    memcpy(a6_rec.fil3 ,parm1->fil3 ,8);
    a6_rec.a6xbc = parm1->a3xbc;
    a6_rec.a6ybc = parm1->a3ybc;
    a6_rec.a6zbc = parm1->a3zbc;
}

```

*CSP transferring control to z/OS XL C under TSO using the XFER statement (Part 2 of 3)*

```

if ((fetch_ptr = (ASM_VOID *) fetch(pgm_call)) == NULL ) {
    printf (" failed on fetch of CSP %s module \n", pgm_call);
}
else {
    fetch_ptr (&a3_progx, &a6_rec);
    rc = release( (void (*)()) fetch_ptr );
    if ( rc != 0 ) {
        printf ("CCNGCP4: rc from release =%d\n", rc );
    }
}
}
}

```

*CSP transferring control to z/OS XL C under TSO using the XFER statement (Part 3 of 3)*

---

## Running under CICS control

For CSP-CICS, note that because all z/OS XL C applications running under CICS must run with AMODE=31, when passing parameters to CSP, you must either

- Pass parameters below the line, or
- Relink the CSP load library with AMODE=31

## Example programs

Figure 230 shows example program CCNGCP5, which shows how parameters are received from a CSP application that uses a CALL statement to transfer control. The z/OS XL C program is expecting to receive an int as a parameter.

---

```

/* this example shows how to call C from CSP under CICS, and how */
/* parameters are passed */

#include <stdio.h>
#include <string.h>
#include <stdlib.h>
#include <math.h>

main()
{
    struct tag_commarea { /* commarea passed to z/OS C from R924A1 */
        int *ptr1 ;
        int *ptr2 ;
        int *ptr3 ;
    } * ca_ptr ;          /* commarea ptr */

    int *parm1_ptr ;
    int *parm2_ptr ;
    int *parm3_ptr ;

                                /* addressability to EIB control block */
                                /* and COMMUNICATION AREA */
    EXEC CICS ADDRESS EIB(dfheiptr) COMMAREA(ca_ptr) ;
    parm1_ptr = ca_ptr->ptr1 ;
    parm2_ptr = ca_ptr->ptr2 ;
    parm3_ptr = ca_ptr->ptr3 ;

    *parm3_ptr = (int) pow((double) *parm1_ptr,
                          (double) *parm2_ptr);

    EXEC CICS RETURN;
}

```

---

*Figure 230. CSP CALLing z/OS XL C under CICS*

Figure 231 (example program CCNGCP6) shows how parameters are received from a CSP application that uses an XFER statement to transfer control.

```

/* this example shows how to XFER control to C from CSP under CICS */
/*      XFER          CALL          */
/* R924A3 ==> CCNGCP6 ==> R924A6   */
/* R924A3 and R924A6 are CSP applications */

#include <math.h>
#include <string.h>

/* structure passed to R924A6*/
void main()
{
  struct {
    struct {
      char          *appl_ptr;
      _Packed struct tag_a3rec *rec3_ptr ;
    } parm_ptr ;

    /* Structure received R924A3*/
    struct tag_a3rec {
      char a3ct [ 4];
      char a3lan [ 4];
      char fill [ 8];          /* packed fields for PLI */
      char fil2 [ 8];          /* packed fields for PLI */
      char fil3 [ 8];          /* packed fields for PLI */
      int a3xbc;               /* int field 1 for z/OS C */
      int a3ybc;               /* int field 2 for z/OS C */
      int a3zbc;               /* int field 3 for z/OS C */
    }
  }
}

```

*CSP transferring control to z/OS XL C under CICS using the XFER statement (Part 1 of 2)*

*Figure 231. CSP transferring control to z/OS XL C under CICS using the XFER statement*

```

_Packed struct tag_a3rec  a3rec ;
char  lk_app1[16] = "USR5ALF.R924A6 " ;

struct tag_a3progx {
    char  alfx  [ 8];
    char  applx [ 8];
};
_Packed struct tag_a3progx a3progx = {"USR5ALF.,"R924A6 " } ;
short  length_a3rec = sizeof(a3rec) ;
char  * pa3rec ;
short  i ;

/*----- start of CSP XFER-ing to C under CICS -----*/

EXEC CICS ADDRESS EIB(dfheiptr);
                                /* retrieve data from CSP */
EXEC CICS RETRIEVE INTO(&a3rec) LENGTH(length_a3rec) ;

a3rec.a3zbc = (int) pow((double) a3rec.a3xbc,
                      (double) a3rec.a3ybc);

/*----- end of CSP XFER-ing to C under CICS -----*/

                                /* call CSP to display results*/
parm_ptr.appl_ptr = lk_app1 ; /* alf.application */
parm_ptr.rec3_ptr = &a3rec ;

                                /* LINK to CSP application */
EXEC CICS LINK PROGRAM("DCBINIT ")
              COMMAREA(parm_ptr)
              LENGTH(8) ;

if (dfheiptr->eibresp2 != 0) {
    printf("CCNGCP6: EXEC CICS LINK returned non zero \n");
    printf("          return code. eibresp2 =%d\n",
          dfheiptr->eibresp2);
}

/*----- end of C calling CSP under CICS -----*/
EXEC CICS RETURN ;
}

```

*CSP transferring control to z/OS XL C under CICS using the XFER statement (Part 2 of 2)*

Figure 232 on page 916 (example program CCNGCP7) The following example program shows how parameters are received from a CSP application that uses a DXFER statement to transfer control. You must receive a structure.

```

/* this example shows how to transfer control to C from CSP under    */
/* CICS, using the DXFR statement */

/*          DXFR          XCTL( equivalent to dxfr)                */
/* R924A3 ==> CCNGCP7 ==> DCBINIT  ( appl R924A5)                */
/* R924A3 is a CSP application */

#include <stdio.h>
#include <string.h>
#include <stdlib.h>
#include <math.h>

main ()
{
    struct tag_a3rec {
        char  a3ct  [ 4];
        char  a3lan [ 4];
        char  fil1  [ 8];          /* packed fields for PLI */
        char  fil2  [ 8];          /* packed fields for PLI */
        char  fil3  [ 8];          /* packed fields for PLI */
        int   a3xbc;
        int   a3ybc;
        int   a3zbc;
    };
}

```

*CSP Transferring Control to z/OS XL C under CICS Using the DXFR Statement (Part 1 of 2)*

*Figure 232. CSP Transferring Control to z/OS XL C under CICS Using the DXFR Statement*

```

/* commarea passed to C/370 from R924A3 */
struct tag_commarea {
  char a3ct [ 4] ;
  char a3lan [ 4];
  char fil1 [ 8]; /* packed fields for PLI */
  char fil2 [ 8]; /* packed fields for PLI */
  char fil3 [ 8]; /* packed fields for PLI */
  int a3xbc;
  int a3ybc;
  int a3zbc;
} * ca_ptr ; /* commarea ptr */

struct tag_a5progc {
  char alf [ 8] ;
  char applc [ 8] ;
  struct tag_a3rec a3rec;
} a5progc = {"USR5ALF.", "R924A5 "};

short length_a3rec = sizeof(struct tag_a3rec) ;
short length_a5progc = sizeof(struct tag_a5progc) ;

/* addressability to EIB control block */
/* and COMMUNICATION AREA */

EXEC CICS ADDRESS EIB(dfheiptr) COMMAREA(ca_ptr) ;

if (dfheiptr->eibcalen == length_a3rec ) {
  memcpy(&a5progc.a3rec, ca_ptr , length_a3rec);

  /* calculate the pow(x,y) */
  a5progc.a3rec.a3zbc = (int) pow((double) a5progc.a3rec.a3xbc,
    (double) a5progc.a3rec.a3ybc);

  EXEC CICS XCTL
    PROGRAM("DCBINIT ")
    COMMAREA(a5progc)
    length(length_a5progc) ;

  if (dfheiptr->eibresp2 != DFHRESP(NORMAL)) {
    printf ("CCNGCP7: failed on xctl call to DCBINIT\n");
    printf (" \n");
  }
}
else {
  printf ("CCNGCP7:length of COMMAREA is different from expected\n");
  printf (" expected %d, actual %d\n",
    length_a3rec, dfheiptr->eibcalen);
  printf (" \n");
  EXEC CICS RETURN;
}

EXEC CICS RETURN;
}

```

*CSP Transferring Control to z/OS XL C under CICS Using the DXFR Statement (Part 2 of 2)*





---

## Chapter 54. Using Data Window Services (DWS)

Data Window Services (DWS) is part of the CSL (Callable Services Library). DWS gives your C or C++ program the ability to manipulate data objects (temporary data objects known as TEMPSPACE, and VSAM linear data sets).

### Notes:

1. XPLINK is not supported with DWS.
2. AMODE 64 applications are not supported with DWS.

To use DWS functions with C code, you do not have to specify a linkage pragma or add any specialized code. Code the DWS function call directly inside your z/OS XL C program just as you would a call to a C or C++ library function and then link-edit the DWS module containing the function you want (such as CSRIDAC, CSRVIEW, CSRSCOT, CSRSAVE or CSRREFR) with your C or C++ program.

To use DWS functions with C++ code, you must specify C linkage for any DWS function that you use. For example, if you wished to use CSRIDAC, you would use a code fragment as shown in Figure 233.

---

```
/* this example shows how DWS may be used with C++ */
#include <stdlib.h>

extern "C" {
    void csridac( char*, char*, char*, char*, char*,
                 char*, long int*, char*, long int*,
                 long int*, long int*);
}

int main(void)
{
    /* Set up the parameters that will be used by CSRIDAC. */

    char op_type[6]      = "BEGIN";
    char object_type[10] = "TEMPSPACE";
    char object_name[45] = "DWS.FILE ";
    char scroll_area[4]  = "YES";
    char object_state[4] = "NEW";
    char access_mode[7] = "UPDATE";
    long int object_size = 8;
    char object_id[9];
    long int high_offset, return_code, reason_code;

    /* Access a DWS TEMPSPACE data object. */

    csridac(op_type, object_type, object_name, scroll_area, object_state,
            access_mode, OBJECT_size, object_id, &high_offset,
            &return_code, &reason_code);

    /* INSERT ADDITIONAL CODE HERE */
}
```

---

Figure 233. Example using DWS and C++

At link-edit time, you should link-edit the DWS module containing the function you want, just as you would for a C program.

In DWS, the data types of the parameters are specified differently from z/OS XL C/C++ data types. When invoking DWS functions from your C or C++ program, you must specify:

- A long int data type for DWS parameters of integer (I\*4) type.
- Character strings (of the required length) for DWS parameters of character type. For example, if the DWS function requires a 9-character object name (in this example we will set the object name to TEMPSPACE) you can declare the parameter in your C or C++ function as follows:

```
char object_type[9] = "TEMPSPACE";
```

For more information on DWS, see *z/OS MVS Programming: Callable Services for High-Level Languages*.

As another example, Figure 234 is an excerpt from a C program (CCNGDW1) that shows parameter declarations for the DWS CSRIDAC function and the function call.

---

```
/* this example shows how DWS may be used with C */

int main(void)
{
    /* Set up the parameters that will be used by CSRIDAC. */

    char op_type[5]      = "BEGIN";
    char object_type[9]  = "TEMPSPACE";
    char object_name[45] = "DWS.FILE ";
    char scroll_area[3]   = "YES";
    char object_state[3] = "NEW";
    char access_mode[6]  = "UPDATE";
    long int object_size = 8;
    char object_id[8];
    long int high_offset, return_code, reason_code;

    /* Access a DWS TEMPSPACE data object. */

    csridac(op_type, object_type, object_name, scroll_area, object_state,
            access_mode, OBJECT_size, OBJECT_id, &high_offset,
            &return_code, &reason_code);
    /* INSERT ADDITIONAL CODE HERE */

    return 0;
}
```

---

Figure 234. z/OS XL C/C++ Using Data Window Services

---

## Chapter 55. Using DB2 Universal Database

Both z/OS Language Environment and z/OS XL C/C++ provide an interface to the IBM DB2 Universal Database™ Licensed Program. For a list of books describing DB2, refer to “DB2” on page 1176.

An XL C/C++ program requests DB2 services by using SQL statements embedded in the program. This source code is translated into host language statements that perform assignments and call a database language interface module. After DB2 processes each request, it returns processing control to the XL C/C++ program.

Any errors that occur during database processing are handled by the database product. If a program is terminated during DB2 processing, DB2 takes appropriate action, depending on the nature of termination.

---

### Preparing an XL C/C++ application to request DB2 services

Before a C/C++ program can request DB2 services, the code with embedded SQL statements must be converted into compilable code. There two ways to do this:

- Use the XL C/C++ DB2 coprocessor (provided by the z/OS XL C compiler).
- Use the DB2 C/C++ precompiler (provided by DB2).

To ensure that you are using compatible releases of z/OS XL C/C++ and DB2, see *z/OS Program Directory*.

Refer to the SQL compiler option in *z/OS XL C/C++ User's Guide* whenever your application performs the following operations:

- Declares global host variables.
- Declares host variables inside functions.
- Includes a header found in SYSLIB or in the LSEARCH path.
- Puts comments at the end of selected lines in the middle of a multiline SQL statement.
- Inserts, updates, or retrieves data using a host variable.
- Embeds SQL statements in template functions or classes.

### Using the XL C/C++ DB2 coprocessor

If all the SQL statements are embedded in XL C programs, you can use the XL C DB2 coprocessor to prepare the program to request DB2 services. You can either run the program through the DB2 C/C++ precompiler before you compile, or you can specify the SQL compiler option when you compile the program. For detailed information about using the SQL option, refer to SQL in *z/OS XL C/C++ User's Guide*. If you are compiling code with SQL in effect, refer to *z/OS Program Directory* for a complete list of SQL suboptions.

When the XL C/C++ SQL(NOSTD) option is in effect, code should be written in codepage IBM-1047 (APL)293).

The following are advantages of using the XL C/C++ DB2 coprocessor instead of the DB2 C/C++ precompiler:

- Host variable names follow the same lexical scoping rules as C/C++ variables.

- Preprocessor directives (such as **#include** and **#define**) are supported.
- Variable-length source input is supported.

**Notes:**

1. Typically, NOSQL is the default compiler option. If your environment is customized to make SQL the default, be aware that the compiler will attempt to call the API that contains DBRMLIB DD even if the source code does not contain SQL statements. When that happens, DB2 generates a message that you can ignore.
2. "SQLCODE", "SQLSTATE", and "sqlca" are not valid user host variable names, because they are reserved by the compiler and DB2 coprocessor as embedded SQL keywords. Previous to the compiler embedding the DB2 coprocessor, the DB2 precompiler did not recognize these three identifiers as keywords, but the new DB2 coprocessor correctly recognizes them and will not successfully compile any source file that attempts to use them as user host variable names. If you are already using any of these reserved keywords as table column names in your program (and referencing them through identically named user host variable names), and you are migrating from a compiler release that uses the DB2 precompiler to one that uses the DB2 coprocessor, you must restructure your queries in order to avoid any conflicts with these reserved keywords. For detailed information, see the documentation available at the following URL:  
<http://www.ibm.com/software/data/db2/zos/library.html>

## Using the DB2 C/C++ precompiler

The DB2 C/C++ precompiler scans source code for potentially SQL-related keywords, such as the following:

- Host variables that can be used in SQL statements in the same source.
- SQL statements that start with the token pair EXEC SQL.

While the DB2 C/C++ precompiler can fully parse the SQL syntax, it has limited capacity for parsing compiler-language-related syntax. If you are compiling code with SQL in effect, all DB2 z/OS XL C/C++ code should be written in codepage IBM-1047 (APL293).

An advantage of using the DB2 C/C++ precompiler instead of the XL C/C++ DB2 coprocessor is that you can obtain a more useful message listing by preprocessing, precompiling, and then compiling source code with embedded SQL statements. Compiler diagnostics refer to line numbers of the translated output from the DB2 C/C++ precompiler, not to the line numbers of your source code. This means that you need both the DB2 C/C++ precompiler listing and the compiler listing to work through the compilation errors. Runtime troubleshooting tools also refer to coordinates of the DB2 C/C++ precompiler output.

---

## Using DB2 services and stored procedures with XPLINK

XL C/C++ applications that are compiled with the XPLINK option can invoke DB2 services that are called through stubs defined as **#pragma linkage(..., OS)**.

When you embed DB2 stored procedures in a program that will be compiled with XPLINK, each CREATE PROCEDURE statement must include a RUN OPTIONS clause that specifies XPLINK(ON).

---

## Examples of how to use XL C/C++ programs to request DB2 services

The examples in this section demonstrate how to code C and C++ programs with embedded SQL statements. You can use them with either the XL C/C++ DB2 coprocessor or the DB2 C/C++ precompiler.

Example CCNGDB4 demonstrates how to code a C program with embedded SQL statements. In Figure 235 on page 924, a program CCNGDB4 creates a table called CTAB1, inserts literal values into the table, and drops the table. You can use this example either by compiling the program with the SQL option in effect or by running the program through the DB2 C/C++ precompiler, and then compiling the generated code with the NOSQL option in effect.

```

/* this example demonstrates how to use SQL with C */

#include <string.h>
#include <stdio.h>

EXEC SQL INCLUDE SQLCA;

int main(void)
{
    if (CreaTab() == -1)
    {
        printf("Test Failed in table-creation.\n");
        exit(-1);
    }

    if (DropTab() == -1)
    {
        printf("Test Failed in table-dropping.\n");
        exit(-1);
    }
    printf("Test Successful.\n");
    return(0);
}

/*
 * This routine creates the table CTAB1 and inserts some values
 * into it
 */

int CreaTab(void)
{
    EXEC SQL CREATE TABLE CTAB1
        ( EMPNO    CHAR(6) NOT NULL,
          FIRSTNME VARCHAR(12) NOT NULL,
          LASTNME  VARCHAR(15) NOT NULL,
          WORKDEPT CHAR(3) NOT NULL,
          PHONENO  CHAR(7),
          EDUCLVL  SMALLINT,
          SALARY   FLOAT(21) );

    if (sqlca.sqlcode != 0)
    {
        printf("ERROR - SQL code returned non-zero for "
              "creation of CTAB1, received %d\n",sqlca.sqlcode);
        return(-1);
    }
}

```

**Using DB2 with C (Part 1 of 2)**

*Figure 235. Using DB2 with C*

```

/* Now insert some values into the table */

EXEC SQL INSERT INTO CTAB1 VALUES
( '097892','John','Adams','003','8883945',3,29500.00 );
EXEC SQL INSERT INTO CTAB1 VALUES
( '000002','Joe','Smith','004','8883791',NULL,25500.00 );
EXEC SQL INSERT INTO CTAB1 VALUES
( '043929','Ralph','Holland','001','8888734',1,NULL);
EXEC SQL INSERT INTO CTAB1 VALUES
( '000010','Holly','Waters','001','8884590',3,29550.00 );

if (sqlca.sqlcode != 0)
{
    printf("ERROR - SQL code returned non-zero for "
           "insert into tables, received %d\n",sqlca.sqlcode);
    return(-1);
}
return(0);
}

/*
 * This routine will drop the table.
 */

int DropTab(void)
{
    EXEC SQL DROP TABLE CTAB1;
    if (sqlca.sqlcode != 0)
    {
        printf("ERROR - SQL code returned non-zero for "
               "drop of CTAB1 received %d??\n",sqlca.sqlcode);
        return(-1);
    }
    EXEC SQL COMMIT WORK;
    return(0);
}

```

#### *Using DB2 with C (Part 2 of 2)*

Figure 236 on page 926 is a C++ code example with embedded SQL statements. The sample code creates, populates, updates, and drops a table called CTAB1V. You can use this example either by compiling the program with the SQL option in effect or by running the program through the DB2 C/C++ precompiler, and then compiling the generated code with the NOSQL option in effect.



```

#include <iostream>

// The test case information
typedef char TestType;

#define NUM_ROWS 3
#define IN_VALUE {'A', 'B', 'C'}
#define OUT_VALUE {'D', 'E', 'F'}

EXEC SQL INCLUDE SQLCA;

class SqlTestTable {
public:
    // The constructor and destructor create and drop the test table
    SqlTestTable() {
        EXEC SQL CREATE TABLE CTAB1V (
            ID          INTEGER      NOT NULL,
            TESTVAR     CHAR(1)      NOT NULL
        ) IN DATABASE DSNUCOMP;

        if (sqlca.sqlcode != 0) {
            std::cout << "ERROR - SQL code returned " << sqlca.sqlcode
                << " for creation of CTAB1V.\n";
        }
    }
    ~SqlTestTable() {
        EXEC SQL DROP TABLE CTAB1V;    // Clean up the database

        if (sqlca.sqlcode != 0) {
            std::cout << "ERROR - SQL code returned " << sqlca.sqlcode
                << " for drop of CTAB1V.\n";
        }
        EXEC SQL COMMIT WORK;
    }

    int insertRow(int idToAdd, TestType inputData) {
        int returnValue = 55;

        EXEC SQL BEGIN DECLARE SECTION;
        int idForRow = idToAdd;
        TestType inputValue = inputData;
        EXEC SQL END DECLARE SECTION;

        EXEC SQL INSERT INTO CTAB1V
            VALUES ( :idForRow, :inputValue );

        if (sqlca.sqlcode != 0) {
            std::cout << "ERROR - SQL code returned " << sqlca.sqlcode
                << " for insert into tables.\n";
            returnValue = 66; // Not returned immediately in case cleanup is needed
        }

        return returnValue;
    }
}

```

### **Using DB2 with C/C++ (Part 1 of 3)**

*Figure 236. Using DB2 with C/C++*

```

int updateTable(int idToChange, TestType inputData) {
    int returnValue = 55;

    EXEC SQL BEGIN DECLARE SECTION;
        int idForRow = idToChange;
        TestType inputValue = inputData;
    EXEC SQL END DECLARE SECTION;

    EXEC SQL UPDATE CTAB1V
        SET TESTVAR = :inputValue
        WHERE ID = :idForRow;

    if (sqlca.sqlcode != 0) {
        std::cout << "ERROR - SQL code returned "
            << sqlca.sqlcode << " for update in tables.\n";
        returnValue = 66; // Not returned immediately in case cleanup is needed
    }

    return returnValue;
}

int checkTable(int idToCheck, TestType value) {
    int returnValue = 55;

    // Try other format variable names
    EXEC SQL BEGIN DECLARE SECTION;
        int idForRow = idToCheck;
        TestType check_var;
    EXEC SQL END DECLARE SECTION;

    EXEC SQL SELECT TESTVAR INTO :check_var
        FROM CTAB1V
        WHERE ID = :idForRow;

    if (sqlca.sqlcode != 0) {
        std::cout << "ERROR - SQL code returned "
            << sqlca.sqlcode << " for SELECT of the data.\n";
        return 66; // Return immediately since no cleanup; nothing else to be done
    }

    if (check_var != value) {
        std::cout << "ERROR - Value in table
            " << check_var << " is not the expected value " << value << ".\n";
        returnValue = 66; // Not returned immediately in case cleanup is needed
    }

    return returnValue;
}
};

```

*Using DB2 with C/C++ (Part 2 of 3)*

```

int main(void) {
SqlTestTable testTable; // Creates the tables
int i = 0;
int returnValue = 55;

TestType aLongVariableName[NUM_ROWS] = IN_VALUE;
TestType expectedResults[NUM_ROWS] = OUT_VALUE;

// SQL Declare's Not needed. Added to see what happens if not used as SQL vars.
EXEC SQL BEGIN DECLARE SECTION;
    TestType inValue;
    TestType outValue;
EXEC SQL END DECLARE SECTION;

// Populate the table using non-host variables as function parameters
for (i = 0; i < NUM_ROWS; i++) {
    returnValue = testTable.insertRow(i, aLongVariableName[i]);

    if (returnValue != 55) {
        return returnValue;
    }
}

// Check to see if the insert went OK using host variables as function parms
for (i = 0; i < NUM_ROWS; i++) {
    inValue = aLongVariableName[i];
    returnValue = testTable.checkTable(i, inValue);

    if (returnValue != 55) {
        return returnValue;
    }
}

// Update the values using host variables as function parameters
for (i = 0; i < NUM_ROWS; i++) {
    outValue = expectedResults[i];
    returnValue = testTable.updateTable(i, outValue);

    if (returnValue != 55) {
        return returnValue;
    }
}

// Check to see if the update went OK using non-host variables as function parms
for (i = 0; i < NUM_ROWS; i++) {
    returnValue = testTable.checkTable(i, expectedResults[i]);

    if (returnValue != 55) {
        return returnValue;
    }
}

return returnValue; // Deletes the table through the destructor
}

```

*Using DB2 with C/C++ (Part 3 of 3)*

---

## Chapter 56. Using Graphical Data Display Manager (GDDM)

The Graphical Data Display Manager (GDDM) provides programmers with a comprehensive set of functions for displaying or printing information in the most effective manner. The major functions provided are:

- A windowing system that the user can tailor to display selected information
- Support for presentation and interaction through the keyboard
- Comprehensive graphics support
- Fonts, including support for double-byte character sets (DBCS)
- Business image support
- Saving and restoring graphics pictures
- Support for many types of display terminals, printers, and plotters.

Because GDDM uses OS-style linkage, calls from C to GDDM require the `#pragma linkage` pragma, as in the following example:

```
#pragma linkage(identifier, OS)
```

In C++ code, calls to and from GDDM require that any GDDM functions you use be prototyped as `extern "OS"`, as shown in the following example:

```
extern "OS" {  
    ASREAD( int *type, int *num, int *count );  
    CHAATT( int num, int *attrib );  
    CHHATT( int num, int *attrib );  
}
```

Because C++ does not support `#pragma linkage`, any existing C code that you are moving to C++ should use the `extern "OS"` specification instead.

When linking a GDDM application, you must add the GDDM library to your SYSLIB concatenation.

### Notes:

1. XPLINK is not supported by GDDM.
2. AMODE 64 applications are not supported by GDDM.

---

## Examples

The following examples demonstrate the interface between C and GDDM by drawing a polar chart to compare the characteristics of two cars.

Figure 237 shows a sample program (CCNGGD1) using GDDM and C.

```
/* this example demonstrates the use of C and GDDM */
#include <string.h>
#pragma linkage(asread,OS)
#pragma linkage(chaatt,OS)
#pragma linkage(chhatt,OS)
#pragma linkage(chhead,OS)
#pragma linkage(chkatt,OS)
#pragma linkage(chkey,OS)
#pragma linkage(chnatt,OS)
#pragma linkage(chnoff,OS)
#pragma linkage(chnote,OS)
#pragma linkage(chpolr,OS)
#pragma linkage(chset,OS)
#pragma linkage(chxlab,OS)
#pragma linkage(chxlat,OS)
#pragma linkage(chxtic,OS)
#pragma linkage(chyrng,OS)
#pragma linkage(chyset,OS)
#pragma linkage(fsinit,OS)
#pragma linkage(fsterm,OS)
/* Arrays are expected for int * and float * */
/* char * can be an array or a string */
extern int asread (int *type, int *num, int *count);
extern int chaatt (int num, int *attrib);
extern int chhatt (int num, int *attrib);
extern int chkatt (int num, int *attrib);
extern int chkey (int, int, char *);
extern int chnatt (int num, int *attrib);
extern int chnoff (double, double);
extern int chnote (char *string, int num, char *title);
extern int chpolr (int, int, float *xdata, float *ydata);
extern int chset (char *character);
extern int chxlab (int num, int, char *);
extern int chxlat (int num, int *attrib);
extern int chxtic (double x, double y);
extern int chyrng (double from, double to);
extern int chyset (char *character);
extern int fsinit (void);
extern int fsterm (void);
/***** Attribute arrays used for the chart. *****/
*****/
int i ;
int h_attrs[4] = { 3, 3, 0, 175 }; /* Head text attribute */
int n_attrs[4] = { 7, 3, 0, 200 }; /* Note text attribute */
int a_attrs[2] = { 7, 1 }; /* X-axis color and line */
int xl_attrs[1] = { 5 }; /* X-label color */
int k_attrs[1] = { 5 }; /* Key text color */
int type, num, count ;
```

*Example using GDDM and C (Part 1 of 2)*

*Figure 237. Example using GDDM and C*

```

float x_data[8] = { 0.0, 1.0, 2.0, 3.0, 4.0, 5.0, 6.0, 7.0 };
float y_data[16] = {
    14190.0, 260.0, 0.21, 0.066, 83.3, 6.0, 19.1, 14190.0,
    12986.0, 290.0, 0.23, 0.066, 95.6, 5.0, 16.2, 12986.0 };
float maxvals[16] = {
    15000.0, 300.0, 0.25, 0.070, 100.0, 6.0, 20.0, 15000.0,
    15000.0, 300.0, 0.25, 0.070, 100.0, 6.0, 20.0, 15000.0 };

int main(void)
{
    fsinit();
    chhatt( 4, h_attrs);
    chhead( 40, "TWO CARS COMPARED USING SEVEN PARAMETERS");
    chaatt( 2, a_attrs);
    chxtic( 1.0, 0.0);
    chxlat( 1, xl_attrs);
    chxlab( 7, 31,
        "PURCHASE PRICE ; $15,000 INSURANCE ;$300/YEAR "
        "$0.25/MILE ;SERVICING $0.070/MILE ;FUEL "
        " 100 BHP/TON; POWER/WT RATIO 6; SEATS"
        " BAGGAGE SPACE; 20 CU FT");
    chyrng ( 0.5,1.0);
    chyset( "NOAXIS");
    chyset( "NOLABEL");
    chyset( "PLAIN");
    chset( "KBOX");
    chkatt( 1, k_attrs);
    chkey( 2, 5, "CAR ACAR B");
    for(i=0; i<16; ++i)
        y_data[i] = y_data[i] / maxvals[i];
    chpolr(2, 8, x_data, y_data);
    chnatt( 4, n_attrs);
    chnoff( 0.0, 0.53);
    chnote( "Z2", 1, "+");
    chset("BNOTE");
    n_attrs[3] = 75;
    chnatt(4,n_attrs);
    chnoff(0.0, 0.60);
    chnote("Z2", 12, "CENTER VALUE");
    chnoff(0.0, 0.55);
    chnote("Z2", 23, "= 1/2 X PERIMETER VALUE");
    /*****
    ** Issue a screen read. When any interrupt is generated **
    ** by the terminal operator, the program terminates. **
    *****/
    asread( &type, &num, &count);
    fsterm();
    exit(0);
}

```

*Example using GDDM and C (Part 2 of 2)*

Figure 238 on page 932 is a similar example program (CCNGGD2) in C++.

```

/* this example demonstrates the use of C++ and GDDM */
#include <stdlib.h>
#include <string.h>
/* Arrays are expected for int * and float * */
/* char * can be an array or a string */
extern "OS" {
    int asread (int *type, int *num, int *count);
    int chaatt (int num, int *attrib);
    int chhatt (int num, int *attrib);
    int chkatt (int num, int *attrib);
    int chkey (int, int, char *);
    int chhead( int, char *);
    int chnatt (int num, int *attrib);
    int chnoff (double, double);
    int chnote (char *string, int num, char *title);
    int chpolr (int, int, float *xdata, float *ydata);
    int chset (char *character);
    int chxlab (int num, int, char *);
    int chxlat (int num, int *attrib);
    int chxtic (double x, double y);
    int chyrng (double from, double to);
    int chyset (char *character);
    int fsinit (void);
    int fsterm (void);
}

```

*Example using GDDM and C++ (Part 1 of 2)*

*Figure 238. Example using GDDM and C++*

```

/*****
** Attribute arrays used for the chart. **
*****/
int i ;
int h_attrs[4] = { 3, 3, 0, 175 }; /* Head text attribute */
int n_attrs[4] = { 7, 3, 0, 200 }; /* Note text attribute */
int a_attrs[2] = { 7, 1 }; /* X-axis color and line */
int xl_attrs[1] = { 5 }; /* X-label color */
int k_attrs[1] = { 5 }; /* Key text color */
int type, num, count ;

float x_data[8] = { 0.0, 1.0, 2.0, 3.0, 4.0, 5.0, 6.0, 7.0 };
float y_data[16] = {
    14190.0, 260.0, 0.21, 0.066, 83.3, 6.0, 19.1, 14190.0,
    12986.0, 290.0, 0.23, 0.066, 95.6, 5.0, 16.2, 12986.0 };
float maxvals[16] = {
    15000.0, 300.0, 0.25, 0.070, 100.0, 6.0, 20.0, 15000.0,
    15000.0, 300.0, 0.25, 0.070, 100.0, 6.0, 20.0, 15000.0 };
int main(void)
{
    fsinit();
    chhatt( 4, h_attrs);
    chhead( 40,"TWO CARS COMPARED USING SEVEN PARAMETERS");
    chaatt( 2,a_attrs);
    chxtic( 1.0, 0.0);
    chxlat( 1, xl_attrs);
    chxlab( 7, 31,
"PURCHASE PRICE ; $15,000 INSURANCE ;$300/YEAR "
"$0.25/MILE ;SERVICING $0.070/MILE ;FUEL "
" 100 BHP/TON; POWER/WT RATIO 6; SEATS"
" BAGGAGE SPACE; 20 CU FT");
    chyrng ( 0.5,1.0);
    chyset( "NOAXIS");
    chyset( "NOLABEL");
    chyset( "PLAIN");
    chset( "KBOX");
    chkatt( 1,k_attrs);
    chkey( 2, 5, "CAR ACAR B");
    for(i=0; i<16; ++i)
        y_data[i] = y_data[i] / maxvals[i];
    chpolr(2, 8, x_data, y_data);
    chnatt( 4, n_attrs);
    chnoff( 0.0, 0.53);
    chnote( "Z2", 1, "+");
    chset("BNOTE");
    n_attrs[3] = 75;
    chnatt(4,n_attrs);
    chnoff(0.0, 0.60);
    chnote("Z2", 12, "CENTER VALUE");
    chnoff(0.0, 0.55);
    chnote("Z2", 23, "= 1/2 X PERIMETER VALUE");
/*****
** Issue a screen read. When any interrupt is generated **
** by the terminal operator, the program terminates. **
*****/
    asread( &type, &num, &count);
    fsterm();
    exit(0);
}

```

*Example using GDDM and C++ (Part 2 of 2)*





---

## Chapter 57. Using the Information Management System (IMS)

This chapter explains how the Information Management System (IMS) and z/OS XL C/C++ coordinate error handling, and describes the limitations to using IMS with z/OS XL C/C++.

z/OS XL C/C++ provides the `ctdli()` C library function to invoke IMS facilities (see *z/OS XL C/C++ Runtime Library Reference* for more information).

You can also invoke IMS facilities with the callable service CEETDLI which is provided by the z/OS Language Environment. The CEETDLI interface performs essentially the same functions as `ctdli()`, but it offers some advantages, particularly if you plan to run an ILC application in IMS. If you use the CEETDLI interface instead of `ctdli()`, condition handling is improved because of the coordination between z/OS Language Environment and IMS condition handling facilities. For complete information on the CEETDLI interface, see *z/OS Language Environment Programming Guide*.

For a description of writing IMS batch and online programs in C or C++, see the appropriate book listed in “IMS/ESA” on page 1176.

To use IMS from z/OS XL C/C++, you must keep the following in mind:

- The file `<ims.h>` must be included in the program.
- `PLIST(OS)` and `TARGET(IMS)` must be used to compile IMS z/OS XL C/C++ application programs. `PLIST(OS)` establishes the correct parameter list format when invoked under IMS, and `TARGET(IMS)` establishes the correct operating environment. The descriptions that follow use the compile-time options. The compile-time option `PLIST(OS)` can alternatively be specified using `#pragma runopts(PLIST(OS))`.
- `TARGET(IMS)` is mandatory, as it establishes the correct operating environment. `PLIST(OS)` must also be used if the program is the initial `main()` program called under IMS. Programs in nested enclaves do not need to be compiled with `PLIST(OS)`.
- The argument count (`argc`) will be set to one (1), and the first element in the argument vector (`argv[0]`) will contain a NULL string when compiled with z/OS XL C compiler and the deprecated `#pragma runopts(PLIST(IMS))` is specified in the source. Otherwise, the argument vector will contain the name of the program.
- IMS provides a language interface module (DFSLI000) that gives a common interface to IMS and DL/I. This module must be link-edited with the application program.

The rest of this chapter is based on the assumption that you are using the `ctdli()` interface.

### Notes:

1. AMODE 64 applications are not supported in an IMS environment.
2. As of V1R2, a non-XPLINK Standard C++ Library DLL allows support for the Standard C++ Library in the IMS subsystem. For further information, see binding programs in *z/OS XL C/C++ User's Guide*.
3. XPLINK applications are supported under the IMS environment.

---

## Handling errors

The IMS environments are sensitive to errors and error-handling issues. A failing IMS transaction or program can potentially corrupt an IMS database. IMS must know about the failure of a transaction or program that has been updating a database so that it can back out any updates made by that failing program.

z/OS XL C/C++ provides extensive error-handling facilities for the programmer, but special steps are required to coordinate IMS and C or C++ error handling so that IMS can do its database rollbacks when a program fails.

When you are using IMS from C or C++:

- Run your C or C++ program with the TRAP(ON) option, and use IMS interfaces by calling the `ctdli()` library function. If your application programs also use SQL facilities provided by DB2, you must modify the user exit CEEBXITA to add the user abend codes 777 and 778 to prevent the error handler from trapping these abends. This will allow deadlocks to be successfully resolved by IMS. See *z/OS Language Environment Programming Guide* for more information on CEEBXITA.
- The `ctdli()` library function will keep track of calls to and returns from IMS. If an abend or program check occurs and the C or C++ error handler gets control, it can determine if the problem arose on the IMS side of the interface or on the C or C++ side.
- If a program check or abend occurs in IMS, when the C or C++ exception handler gets control, it immediately issues an ABEND. The IMS Region Controller gets control next and ensures that the integrity of the database is preserved.
- If a program check occurs in the C or C++ program rather than in IMS, all the facilities of C or C++ error handling apply, provided that you meet certain conditions when you code your program. For any error condition that arises, you must do one of the following:
  1. Resolve the error completely so that the application can continue.
  2. Have IMS back out the program's updates by issuing a rollback call to IMS, and then terminate the program.
  3. Make sure that the program terminates abnormally and provide an installation-modified runtime user exit that turns all abnormal terminations into operating system ABENDs to effect IMS rollbacks. See *z/OS Language Environment Programming Guide* for more information.

The errors you most likely can fix in your program are arithmetic exception (SIGFPE) conditions. It is unlikely that you can resolve other types of program checks or system abends in your program.

Any program that invokes IMS by way of some other IMS interface should be executed with TRAP(OFF). You should be sure that the program contains code to issue a rollback call to IMS before terminating after an error. Refer to *z/OS Language Environment Programming Reference* for more information about the limitations of using TRAP(OFF).

---

## Other considerations

A *program communication block* (PCB) is a control block used by IMS to describe results of a DL/I call (DB PCB) or the results of a message retrieval or insertion (I/O PCB) made by your program. A valid PCB is one that has been correctly initialized by IMS and passed to you through your C or C++ program. For details on PCBs, refer to "IMS/ESA" on page 1176. See also the sample C-IMS and C++-IMS programs in *z/OS XL C/C++ Runtime Library Reference*.

If you are running a C program under TSO or IMS, be aware of the effects of PLIST(OS), ENV(IMS), and their combinations when specified using the #pragma runopts preprocessor directive. Table 347 shows the combinations of PLIST(OS) and ENV(IMS) and the resulting PCB generated under each of the environments.

Table 347. PCB generated for C program under TSO and IMS

Combination	Running under TSO	Running under IMS
ENV(IMS) only	Invalid PCB	Valid PCB
PLIST(OS) only	Null PCB	Null PCB
ENV(IMS) and PLIST(OS)	Invalid PCB	Valid PCB

For more information on the runtime options ENV and PLIST, see *z/OS Language Environment Programming Reference*.

If you are running a C or C++ program under TSO or IMS, be aware of the effects of specifying compiler options PLIST(OS), TARGET(IMS), and their combinations. Table 348 shows the combinations of PLIST(OS) and TARGET(IMS) and the resulting PCB generated under each of the environments.

Table 348. PCB generated for C or C++ program under TSO and IMS

Combination	Running under TSO	Running under IMS
TARGET(IMS) only	Invalid PCB	Valid PCB
PLIST(OS) only	Null PCB	Null PCB
TARGET(IMS) and PLIST(OS)	Invalid PCB	Valid PCB

For both C and C++, specifying PLIST(OS) under either TSO or IMS results in an argc value of 1 (one), and argv[0] = NULL. For more information on the compiler options TARGET(IMS) and PLIST(OS), see *z/OS XL C/C++ User's Guide*.

## Examples

The sample C++ program CCNGIM1 (Figure 239) makes an IMS call and checks the return code status of the call in IMS batch. Header file CCNGIM3 (Figure 241 on page 940) is included by this program.

```

/* this is an example of how to use IMS with C++ */

#pragma runopts(env(ims),plist(os))
#include <ims.h>
#include <stdio.h>
#include <string.h>
#include <stdlib.h>
#include "ccngim3.h"

int main(void) {
/*****
/* Declare the database pointer control blocks for each database */
/*****
    PCB_STRUCT_8_TYPE *locdb_ptr,*orddb_ptr;

```

*C++ Program using IMS (Part 1 of 2)*

Figure 239. C++ Program using IMS

```

/*****
/* IO areas used for DL/I calls */
/*****

    auto IOA2 aio_area, a2io_area;
    static IOA2 sio_area;
    IOA2 *io_area;
/*****
/* SSAs for DL/I calls */
/*****

    static char qual0[] = "ORDER (ORDKEY =333333)";
    static char qual1[] = "ORDITEM ";
    static char qual2[] = "DELIVERY ";
    static int six = 6;
    static int four = 4;
    static char gu[5] = "GU ";
    static char isrt[5] = "ISRT";

    int rc;
    int failed = 0; /* Indicate if any part of test case failed.
*/

/*****
/* Get the pointers to the databases from the parameter list */
/*****

    locdb_ptr = (__pcblist[1]);
    orddb_ptr = (__pcblist[2]);
/*****
/* Make some calls to the database and change its contents */
/*****

    printf("IMS Test starting\n");

    io_area = (IOA2 *)malloc(sizeof(IOA2));

/*****
/* Issue a DL/I call with arguments below the line (using CTDLI) */
/*****

/*****
/* The first parameter for ctdli is an int specifying the number of */
/* arguments-this parameter was optional under C but is mandatory */
/* under C++ */
/*****
    rc = ctdli(six,gu,orddb_ptr,&aio_area,qual0,qual1,qual2);

    if ((orddb_ptr->stat_code[0] == ' ' && orddb_ptr->stat_code[1] == '
')
        && (rc == 0))
        printf("Call to CTDLI returned successfully\n");
    else
    {
        printf("Call to CTDLI returned status of %c%c.\n",
            orddb_ptr->stat_code[0],orddb_ptr->stat_code[1]);
        failed = 1;
    }
    if (failed == 0)
        printf("Test Successful\n");
    else printf("Test Failed");

    return(0);
}

```

*C++ Program using IMS (Part 2 of 2)*

Figure 240 shows a sample C program (CCNGIM2) that makes an IMS call and checks the return code status of the call in IMS batch. Header file CCNGIM3 (Figure 241 on page 940) is included by this program.

```

/* This is an example of how to use IMS with C */

#pragma runopts(env(ims),plist(os))
#include <ims.h>
#include <stdio.h>
#include <string.h>
#include <stdlib.h>
#include "ccngim3.h"

int main(void) {
/*****
/* Declare the database pointer control blocks for each database */
*****/

    PCB_STRUCT_8_TYPE *locdb_ptr,*orddb_ptr;

/*****
/* IO areas used for DL/I calls */
*****/

    auto IOA2 aio_area, a2io_area;
    static IOA2 sio_area;
    IOA2 *io_area;

/*****
/* SSAs for DL/I calls */
*****/

    static char qual0[] = "ORDER (ORDKEY =333333)";
    static char qual1[] = "ORDITEM ";
    static char qual2[] = "DELIVERY ";
    static int six = 6;
    static int four = 4;
    static char gu[4] = "GU ";
    static char isrt[4] = "ISRT";
    int rc;
    int failed = 0; /* Indicate if any part of test case failed. */

/*****
/* Get the pointers to the databases from the parameter list */
*****/

    locdb_ptr = (__pcblist[1]);
    orddb_ptr = (__pcblist[2]);

/*****
/* Make some calls to the database and change its contents */
*****/

    printf("IMS Test starting\n");

    io_area = malloc(sizeof(IOA2));

```

*C Program using IMS (Part 1 of 2)*

*Figure 240. C Program using IMS*

```

/*****
/* Issue a DL/I call with arguments below the line (using CTDLI) */
/*****

    rc = ctdli(six,gu,orddb_ptr,&aio_area,qual0,qual1,qual2);

    if ((orddb_ptr->stat_code[0] == ' ' && orddb_ptr->stat_code[1]!='
')
        && (rc == 0))
        printf("Call to CTDLI returned successfully\n");
    else
    {
        printf("Call to CTDLI returned status of %c%c.\n",
            orddb_ptr->stat_code[0],orddb_ptr->stat_code[1]);
        failed = 1;
    }
    if (failed == 0)
        printf("Test Successful\n");
    else printf("Test Failed");

    return(0);
}

```

### *C Program using IMS (Part 2 of 2)*

Figure 241 shows the header file (CCNGIM3) that is used by both the C and the C++ examples in Figure 239 on page 937 and Figure 240 on page 939, respectively.

```

/* this header file is used with the IMS example */

/*-----*/
/*   DB PCB       */
/*-----*/
typedef struct {
    char db_name[8];
    char seg_level[2];
    char stat_code[2];
    char proc_opt[4];
    int dli;
    char seg_name[8];
    int len_kfb;
    int no_senseg;
    char key_fb[2];
} DB_PCB;
/*-----*/
/*   IO PCB       */
/*-----*/
typedef struct {
    char term[8];
    char ims_res[2];
    char stat_code[2];
    char date[4];
    char time[4];
    int input_seq;
    char output_mess[8];
    char mod_nme[8];
    char user_id[8];
} IO_AREA;

```

### *Header file for IMS example (Part 1 of 2)*

Figure 241. Header file for IMS example

```

/*-----*/
/* SPA DATA */
/*-----*/
typedef struct {
    short int uosplth;
    char uospres1[4];
    char uosptran[8];
    char uospuser;
    char fill[85];
} SPA_DATA;
/*-----*/
/* INPUT MESSAGE */
/*-----*/
typedef struct {
    short int ll;
    char zz[2];
    char fill[2];
    char numb[4];
    char nme[6];
} IN_MSG;
/*-----*/
/* OUTPUT MESSAGE */
/*-----*/
typedef struct {
    short int ll;
    char z1;
    char z2;
    char fill[2];
    char sca[2];
} OUT_MSG;
/*-----*/
/* IO AREA */
/*-----*/
typedef struct {
    char key[20];
} IOA1;

typedef struct {
    char item[40];
} IOA2;

```

*Header file for IMS example (Part 2 of 2)*





---

## Chapter 58. Using the Query Management Facility (QMF)

The z/OS XL C/C++ compiler's support of the Query Management Facility (QMF) interface, a query and report writing facility, enables you to write applications through the SAA callable interface. You can create applications to perform a variety of tasks such as data entry, query building, administration aids, and report analysis.

The z/OS XL C++ compiler itself does not support QMF. However, QMF can be accessed through C code that is statically or dynamically called from C++.

You must include the header file DSQCOMM.C (provided with the QMF application), which contains the function and structure definitions necessary to use the QMF interface.

For information on how to write your z/OS XL C/C++ applications with the QMF interface, see the appropriate QMF manual listed in "QMF" on page 1176.

### Notes:

1. AMODE 64 applications are not supported by QMF.
2. XPLINK is not supported by QMF.

---

## Example programs

Figure 242 is a sample program (CCNGQM1) that demonstrates the interface between the QMF facility and the z/OS XL C/C++ compiler.

```
/* this example shows how to use the interface between QMF and C */
#include <string.h>
#include <stdlib.h>
#include <DSQCOMM.C> /* QMF header file */

int main(void)
{
    struct dsqcomm communication_area; /* found in DSQCOMM.C */

    /******
    /* Query interface command length and commands */
    /******
    signed long command_length;
    static char start_query_interface [] = "START";
    static char set_global_variables [] = "SET GLOBAL";
    static char run_query [] = "RUN QUERY Q1";
    static char print_report [] = "PRINT REPORT (FORM=F1)";
    static char end_query_interface [] = "EXIT";

    /******
    /* Query command extension, number of parameters and lengths */
    /******
    signed long number_of_parameters;
    signed long keyword_lengths[10];
    signed long data_lengths[10];
```

*QMF interface example (Part 1 of 3)*

*Figure 242. QMF interface example*

```

/*****
/* Variable data type constants
*/
/*****
static char char_data_type[] = DSQ_VARIABLE_CHAR;
static char int_data_type[] = DSQ_VARIABLE_FINT;

/*****
/* Keyword parameter and value for START command
*/
/*****
static char start_keywords[] = "DSQSCMD";
static char start_keyword_values[] = "USERCMD1";

/*****
/* Keyword parameter and value for SET command
*/
/*****
#define SIZE_VAL 8
char set_keywords[3][SIZE_VAL];
signed long set_values[3];

/*****
/* Start a Query Interface Session
*/
/*****
number_of_parameters = 1;
command_length = sizeof(start_query_interface);
keyword_lengths[0] = sizeof(start_keywords);
data_lengths[0] = sizeof(start_keyword_values);
dsqcice(&communication_area,
        &command_length,
        START_query_interface[0],
        &number_of_parameters,
        &keyword_lengths[0],
        START_keywords[0],
        &data_lengths[0],
        START_keyword_values[0],
        char_data_type[0]);

/*****
/* Set numeric values into query using SET command
*/
/*****
number_of_parameters = 3;
command_length = sizeof(set_global_variables);
strcpy(set_keywords[0], "MYVAR01");
strcpy(set_keywords[1], "SHORT");
strcpy(set_keywords[2], "MYVAR03");
keyword_lengths[0] = SIZE_VAL;
keyword_lengths[1] = SIZE_VAL;
keyword_lengths[2] = SIZE_VAL;
data_lengths[0] = sizeof(long);
data_lengths[1] = sizeof(long);
data_lengths[2] = sizeof(long);
set_values[0] = 20;
set_values[1] = 40;
set_values[2] = 84;
dsqcice(&communication_area,
        &command_length,
        &set_global_variables[0],
        &number_of_parameters,
        &keyword_lengths[0],
        &set_keywords[0],
        &data_lengths[0],
        &set_values[0],
        &int_data_type[0]);

```

*QMF interface example (Part 2 of 3)*

```

/*****
/* Run a Query
/*****
    command_length = sizeof(run_query);
    dsqic(&communication_area, &command_length,
          &run_query[0]);

/*****
/* Print the results of the query
/*****
    command_length = sizeof(print_report);
    dsqic(&communication_area, &command_length,
          &print_report[0]);

/*****
/* End the query interface session
/*****
    command_length = sizeof(end_query_interface);
    dsqic(&communication_area, &command_length,
          &end_query_interface[0]);

    return 0;
}

```

*QMF interface example (Part 3 of 3)*

Figure 243 is a sample program (CCNGQM2) that demonstrates how a C++ program may call a C program (see Figure 244 on page 946) that accesses QMF.

---

```

#include <stdio.h>
#include <stdlib.h>
#include <string.h>
#include <ctype.h>

extern "C" {
    int Gen_Report(void);
}

int main( int argc, char *argv[])
{
    int cmd;

    if (argc < 2 )
    {
        printf("ERROR - program takes at least one parm");
    }
    else
    {
        cmd=argv[1][0];
        cmd=toupper(cmd);
        switch (cmd)
        {
            case 'R':
                {
                    Gen_Report();
                    break;
                }
            default:
                printf("%d is an invalid option.\n");
        }
    }
}

```

---

*Figure 243. C++ Calling a C program that accesses QMF*

Sample program CCNGQM3 (Figure 244) is called from the C program shown in Figure 243 on page 945.

```

/*
this example shows how C++ can access QMF by way of a C program */
/* part 2 of 2-this file is called from C */
/* other file is CCNGQM2 */

#include <string.h>
#include <stdlib.h>
#include <DSQCOMM.C.H> /* QMF header file */

int Gen_Report(void)
{
    struct dsqcomm communication_area; /* found in DSQCOMM.C */

    /******
    /* Query interface command length and commands */
    /******
    signed long command_length;
    static char start_query_interface [] = "START";
    static char set_global_variables [] = "SET GLOBAL";
    static char run_query [] = "RUN QUERY Q1";
    static char print_report [] = "PRINT REPORT (FORM=F1)";
    static char end_query_interface [] = "EXIT";

    /******
    /* Query command extension, number of parameters and lengths */
    /******
    signed long number_of_parameters;
    signed long keyword_lengths[10];
    signed long data_lengths[10];

    /******
    /* Variable data type constants */
    /******
    static char char_data_type[] = DSQ_VARIABLE_CHAR;
    static char int_data_type[] = DSQ_VARIABLE_FINT;

    /******
    /* Keyword parameter and value for START command */
    /******
    static char start_keywords[] = "DSQSCMD";
    static char start_keyword_values[] = "USERCMD1";

    /******
    /* Keyword parameter and value for SET command */
    /******
    #define SIZE_VAL 8
    char set_keywords[3][SIZE_VAL];
    signed long set_values[3];

```

*C program that accesses QMF (Part 1 of 3)*

*Figure 244. C program that accesses QMF*

```

/*****
/* Start a Query Interface Session */
/*****
number_of_parameters = 1;
command_length = sizeof(start_query_interface);
keyword_lengths[0] = sizeof (start_keywords);
data_lengths[0] = sizeof(start_keyword_values);
dsqcice(&communication_area,
        &command_length,
        &start_query_interface[0],
        &number_of_parameters,
        &keyword_lengths[0],
        &start_keywords[0],
        &data_lengths[0],
        &start_keyword_values[0],
        &char_data_type[0]);

/*****
/* Set numeric values into query using SET command */
/*****
number_of_parameters = 3;
command_length = sizeof(set_global_variables);
strcpy(set_keywords[0], "MYVAR01");
strcpy(set_keywords[1], "SHORT");
strcpy(set_keywords[2], "MYVAR03");
keyword_lengths[0] = SIZE_VAL;
keyword_lengths[1] = SIZE_VAL;
keyword_lengths[2] = SIZE_VAL;
data_lengths[0] = sizeof(long);
data_lengths[1] = sizeof(long);
data_lengths[2] = sizeof(long);
set_values[0] = 20;
set_values[1] = 40;
set_values[2] = 84;
dsqcice(&communication_area,
        &command_length,
        &set_global_variables[0],
        &number_of_parameters,
        &keyword_lengths[0],
        &set_keywords[0],
        &data_lengths[0],
        &set_values[0],
        &int_data_type[0]);

```

*C program that accesses QMF (Part 2 of 3)*

```

/*****
/* Run a Query
*/
/*****
    command_length = sizeof(run_query);
    dsqcic(&communication_area, &command_length,
          &run_query[0]);

/*****
/* Print the results of the query
*/
/*****
    command_length = sizeof(print_report);
    dsqcic(&communication_area, &command_length,
          &print_report[0]);

/*****
/* End the query interface session
*/
/*****
    command_length = sizeof(end_query_interface);
    dsqcic(&communication_area, &command_length,
          &end_query_interface[0]);

    exit(0);
}

```

*C program that accesses QMF (Part 3 of 3)*

---

## Part 8. Internationalization: Locales and Character Sets

This part includes the following topics related to Locales and Character Sets:

- Chapter 59, "Introduction to locale," on page 951
- Chapter 60, "Building a locale," on page 955
- Chapter 61, "Customizing a locale," on page 1005
- Chapter 62, "Customizing a time zone," on page 1013
- Chapter 63, "Definition of S370 C, SAA C, and POSIX C locales," on page 1015
- Chapter 64, "Code set conversion utilities," on page 1023
- Chapter 65, "Coded character set considerations with locale functions," on page 1047
- Chapter 66, "Bidirectional language support," on page 1065





---

## Chapter 59. Introduction to locale

This topic introduces locales and how they relate to the internationalization of programs.

---

### Internationalization in programming languages

Internationalization in programming languages is a concept that comprises *externally stored cultural data*, a set of *programming tools* to create such cultural data, a set of *programming interfaces* to access this data, and a set of *programming methods* that enable you to use provided interfaces to write programs that do not make any assumptions about the cultural environments they run in. Such programs modify their behavior according to the user's cultural environment, specified during the program's execution.

---

### Elements of internationalization

The typical elements of cultural environment are as follows:

#### **Native language**

The text that the executing program uses to communicate with a user or environment, that is, the natural language of the end user.

#### **Character sets and coded character sets**

Map an alphabet, the characters used in a particular language, onto the set of hexadecimal values (code points) that uniquely identify each character. This mapping creates the coded character set, which is uniquely identified by the character set it encodes, the set of code point values, and the mapping between these two.

For example IBM-273, also known as the German Code Page, and IBM-297, also known as the French Code Page, are two coded character sets which assign different EBCDIC encodings in the hexadecimal range 40 to FE to the same Latin Alphabet Number 1. IBM S/390 systems in Germany and France both use this Latin 1 alphabet, which is specified by International Standard ISO/IEC 8859-1. However, systems in Germany are configured for encodings of this alphabet given by IBM-273; whereas, systems in France are configured for encodings of this alphabet given by IBM-297.

IBM-1027, Japanese Latin Code Page, is another example of a coded character set. It assigns EBCDIC encodings in the hexadecimal range 40 to FE to characters specified by Japanese Industrial Standard JIS X 201-1978 plus encodings for a few more Latin characters selected by IBM. The resulting alphabet defined by IBM-1027 consists of some characters found in Latin Alphabet Number 1 and some Katakana characters. IBM S/390 systems in Japan are configured for encodings of this alphabet assigned by IBM-1027.

#### **Collating and ordering**

The relative ordering of characters used for sorting.

#### **Character classification**

Determines the type of character (alphabetic, numeric, and so forth) represented by a code point.

**Character case conversion**

Defines the mapping between uppercase and lowercase characters within a single character set.

**Date and time format**

Defines the way date and time data are formatted (names of weekdays and months; order of month, day, and year, and so forth).

**Format of numeric and non-numeric numbers**

Define the way numbers and monetary units are formatted with commas, decimal points, and so forth.

---

## **z/OS XL C/C++ Support for internationalization**

The z/OS XL C/C++ compiler and library support of internationalization is based on the IEEE POSIX P1003.2 and X/Open Portability Guide standards for global locales and coded character set conversion. See Chapter 60, “Building a locale,” on page 955 for more information about locales.

---

## **Locales and localization**

A *locale* is a collection of data that encodes information about the cultural environment. *Localization* is an action that establishes the cultural environment for an application by selecting the active locale. Only one locale can be active at one time, but a program can change the active locale at any time during its execution. The active locale affects the behavior of the locale-sensitive interfaces for the entire program. This is called the *global locale model*.

### **Locale-sensitive interfaces**

The z/OS XL C/C++ runtime library provides many interfaces to manipulate and access locales. You can use these interfaces to write internationalized C programs. The following list summarizes all the z/OS XL C/C++ library functions which affect or are affected by the current locale.

**Selecting locale**

Changing the characteristics of the user's cultural environment by changing the current locale: `setlocale()`

**Querying locale**

Retrieving the locale information that characterizes the user's cultural environment:

**Monetary and numeric formatting conventions:**

`localeconv()`

**Date and time formatting conventions:**

`localdtconv()`

**User-specified information:**

`n1_langinfo()`

**Encoding of the variant part of the portable character set:**

`getsyntax()`

**Character set identifier:**

`csid()`, `wcsid()`

**Classification of characters:**

**Single-byte characters:**

isalnum(), isalpha(), isblank(), iscntrl(), isdigit(), isgraph(),  
islower(), isprint(), ispunct(), isspace(), isupper(), isxdigit()

**Wide characters:**

iswalnum(), iswalphabeta(), iswblank(), iswcntrl(), iswdigit(),  
iswgraph(), iswlower(), iswprint(), iswpunct(), iswspace(),  
iswupper(), iswxdigit(), wctype(), iswctype()

**Character case mapping:****Single-byte characters:**

tolower(), toupper()

**Wide characters:**

towlower(), towupper()

**Multibyte character and multibyte string conversion:**

mblen(), mbrlen(), mbtowc(), mbrtowc(), wctomb(), wcrtomb(), mbstowcs(),  
mbsrtowcs(), wcstombs(), wcsrtombs(), mbsinit(), wctob(), mbrtoc16(),  
mbrtoc32(), c16rtomb(), c32rtomb()

**String conversions to arithmetic:**

strtod(), wcstod(), strtol(), wcstol(), strtoul(), wcstoul(), atof(),  
atoi(), atol()

**String collating:**

strcoll(), strxfrm(), wcscoll(), wcsxfrm()

**Character display width:**

wcswidth(), wwidth()

**Date, time, and monetary formatting:**

strftime(), strptime(), wcsftime(), mktime(), ctime(), gmtime(),  
localtime() strfmon()

**Formatted input/output:**

printf() (and family of functions), scanf() (and family of functions),  
vswprintf(), swprintf(), swscanf(), snprintf(), vsnprintf()

**Processing regular expressions:**

regcomp(), regexexec()

**Wide character unformatted input/output:**

fgetwc(), fgetws(), fputwc(), fputws(), getwc(), getwchar(), putwc(),  
putwchar(), ungetwc()

**Response matching:**

rpmatch()

**Collating elements:**

ismccollet(), strtocoll(), colltostr(), collequiv(), collrange(),  
collorder(), cclass(), maxcoll(), getmccoll(), getwmccoll()



---

## Chapter 60. Building a locale

Cultural information is encoded in the locale source file using the locale definition language. One locale source file characterizes one cultural environment. See Appendix D, “Locales supplied with z/OS XL C/C++,” on page 1091 for a list of the locale source and object files supplied with the z/OS XL C/C++ compiler.

The locale source file is processed by the locale compilation tool, called the `localedef` tool.

To enhance portability of the locale source files, certain information related to the character sets can be encoded using the symbolic names of characters. The mapping between the symbolic names and the characters they represent and its associated hexadecimal value is defined in the *character set description file* or *charmap* file. See Appendix E, “Charmap files supplied with z/OS XL C/C++,” on page 1117 for a list of the charmap files shipped with your product.

Figure 245 shows the conceptual model of the locale build process.

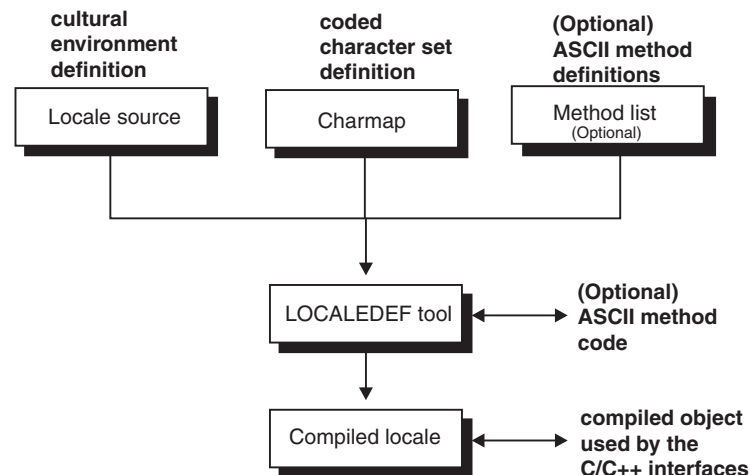

Figure 245. Conceptual model of the locale build process

---

### Limitations of enhanced ASCII

This section explains under what conditions you can use Enhanced ASCII.

- A subset of C headers and functions is provided in ASCII. For more information, see *z/OS XL C/C++ Runtime Library Reference*.
- The only way to get to the ASCII version of functions and the external variables `environ` and `tzname` is to use the appropriate IBM header files.
- ASCII applications may read, but not update, environment variables using the `environ` external variable. Updates to the environment variables using `environ` in an ASCII application causes unpredictable results and may result in an abend. Language Environment maintains two equivalent arrays of environment variables when running an ASCII application, one with EBCDIC encodings and the other with ASCII encodings. All ASCII compile units that use the `environ` external variable must include `<stdlib.h>` so that `environ` can be mapped to

access the ASCII encoded environment strings. If `<stdlib.h>` is not included, **environ** will refer to the EBCDIC representation of the environment variable strings.

Enhanced ASCII provides limited conversion of ASCII to EBCDIC, and EBCDIC to ASCII. The character set or alphabet that is associated with any locale consists of the following:

- A common, XPG4-defined subset of characters such as POSIX portable characters
- A unique, locale-specific subset of characters such as NLS characters

The conversion only applies to the portable subset of characters that are associated with a locale. Only the EBCDIC IBM-1047 encoding of portable characters is supported.

You might encounter unexpected results in the following situations:

- If Enhanced ASCII applications run in locales that contain non-Latin Alphabet Number 1 NLS characters, C-RTL functions might copy some of the locale's non-Latin 1 NLS characters into buffers that the application is writing to stdout or another files in the z/OS UNIX file system. The non-Latin Alphabet Number 1 NLS characters would then cause problems during automatic conversion.
- Language Environment applications select non-English message files. If your NATLANG runtime option is not UEN or ENU, messages directed to the Language Environment message file are not converted to ASCII.

---

## Using the charmap file

The charmap file defines a mapping between the symbolic names of characters and the hexadecimal values associated with the character in a given coded character set. Optionally, it can provide the alternate symbolic names for characters. Characters in the locale source file can be referred to by their symbolic names or alternate symbolic names, thereby allowing for writing generic locale source files independent of the encoding of the character set they represent.

Each charmap file must contain at least the definition of the portable character set and the character symbolic names associated with each character. The characters in the portable character set and the corresponding symbolic names, and optional alternate symbolic names, are defined in Table 349.

*Table 349. Characters in portable character set and corresponding symbolic names*

Symbolic Name	Alternate Name	Character	Hex Value (EBCDIC)	Hex Value (ASCII)
<NUL>			00	00
<tab>	<SE10>		05	09
<vertical-tab>	<SE12>		0b	0b
<form-feed>	<SE13>		0c	0c
<carriage-return>	<SE14>		0d	0d
<newline>	<SE11>		15	0a
<backspace>	<SE09>		16	08
<alert>	<SE08>		2f	07
<space>	<SP01>		40	20
<period>	<SP11>	.	4b	2e

Table 349. Characters in portable character set and corresponding symbolic names (continued)

Symbolic Name	Alternate Name	Character	Hex Value (EBCDIC)	Hex Value (ASCII)
<less-than-sign>	<SA03>	<	4c	3c
<left-parenthesis>	<SP06>	(	4d	28
<plus-sign>	<SA01>	+	4e	2b
<ampersand>	<SM03>	&	50	26
<right-parenthesis>	<SP07>	)	5d	29
<semicolon>	<SP14>	;	5e	3b
<hyphen>	<SP10>	-	60	2d
<hyphen-minus>	<SP10>	-	60	2d
<slash>	<SP12>	/	61	2f
<solidus>	<SP12>	/	61	2f
<comma>	<SP08>	,	6b	2c
<percent-sign>	<SM02>	%	6c	25
<underscore>	<SP09>	_	6d	5f
<low-line>	<SP09>	_	6d	5f
<greater-than-sign>	<SA05>	>	6e	3e
<question-mark>	<SP15>	?	6f	3f
<colon>	<SP13>	:	7a	3a
<apostrophe>	<SP05>	'	7d	27
<equals-sign>	<SA04>	=	7e	3d
<quotation-mark>	<SP04>	"	7f	22
<a>	<LA01>	a	81	61
<b>	<LB01>	b	82	62
<c>	<LC01>	c	83	63
<d>	<LD01>	d	84	64
<e>	<LE01>	e	85	65
<f>	<LF01>	f	86	66
<g>	<LG01>	g	87	67
<h>	<LH01>	h	88	68
<i>	<LI01>	i	89	69
<j>	<LJ01>	j	91	6a
<k>	<LK01>	k	92	6b
<l>	<LL01>	l	93	6c
<m>	<LM01>	m	94	6d
<n>	<LN01>	n	95	6e
<o>	<LO01>	o	96	6f
<p>	<LP01>	p	97	70
<q>	<LQ01>	q	98	71
<r>	<LR01>	r	99	72



Table 349. Characters in portable character set and corresponding symbolic names (continued)

Symbolic Name	Alternate Name	Character	Hex Value (EBCDIC)	Hex Value (ASCII)
<s>	<LS01>	s	a2	73
<t>	<LT01>	t	a3	74
<u>	<LU01>	u	a4	75
<v>	<LV01>	v	a5	76
<w>	<LW01>	w	a6	77
<x>	<LX01>	x	a7	78
<y>	<LY01>	y	a8	79
<z>	<LZ01>	z	a9	7a
<A>	<LA02>	A	c1	41
<B>	<LB02>	B	c2	42
<C>	<LC02>	C	c3	43
<D>	<LD02>	D	c4	44
<E>	<LE02>	E	c5	45
<F>	<LF02>	F	c6	46
<G>	<LG02>	G	c7	47
<H>	<LH02>	H	c8	48
<I>	<LI02>	I	c9	49
<J>	<LJ02>	J	d1	4a
<K>	<LK02>	K	d2	4b
<L>	<LL02>	L	d3	4c
<M>	<SM02>	M	d4	4d
<N>	<LN02>	N	d5	4e
<O>	<LO02>	O	d6	4f
<P>	<LP02>	P	d7	50
<Q>	<LQ02>	Q	d8	51
<R>	<LR02>	R	d9	52
<S>	<LS02>	S	e2	53
<T>	<LT02>	T	e3	54
<U>	<LU02>	U	e4	55
<V>	<LV02>	V	e5	56
<W>	<LW02>	W	e6	57
<X>	<LX02>	X	e7	58
<Y>	<LY02>	Y	e8	59
<Z>	<LZ02>	Z	e9	5a
<zero>	<ND10>	0	f0	30
<one>	<ND01>	1	f1	31
<two>	<ND02>	2	f2	32
<three>	<ND03>	3	f3	33

Table 349. Characters in portable character set and corresponding symbolic names (continued)

Symbolic Name	Alternate Name	Character	Hex Value (EBCDIC)	Hex Value (ASCII)
<four>	<ND04>	4	f4	34
<five>	<ND05>	5	f5	35
<six>	<ND06>	6	f6	36
<seven>	<ND07>	7	f7	37
<eight>	<ND08>	8	f8	38
<nine>	<ND09>	9	f9	39
<vertical-line>	<SM13>		(4f)	7c
<exclamation-mark>	<SP02>	!	(5a)	21
<dollar-sign>	<SC03>	\$	(5b)	24
<circumflex>	<SD15>	^	(5f)	5e
<circumflex-accent>	<SD15>	^	(5f)	5e
<grave-accent>	<SD13>		(79)	60
<number-sign>	<SM01>	#	(7b)	23
<commercial-at>	<SM05>	@	(7c)	40
<tilde>	<SD19>		(a1)	7e
<left-square-bracket>	<SM06>	[	(ad)	5b
<right-square-bracket>	<SM08>	]	(bd)	5d
<left-brace>	<SM11>	{	(c0)	7b
<left-curly-bracket>	<SM11>	{	(c0)	7b
<right-brace>	<SM14>	}	(d0)	7d
<right-curly-bracket>	<SM14>	}	(d0)	7d
<backslash>	<SM07>	\	(e0)	5c
<reverse-solidus>	<SM07>	\	(e0)	5c

The portable character set is the basis for the syntactic and semantic processing of the localedef tool, and for most of the utilities and functions that access the locale object files. Therefore the portable character set must always be defined. It is conceptually divided into two parts:

#### Invariant

Characters for which encoding must be constant among all charmap files. The required encoded values are specified in Table 349 on page 956. If any of these values change, the behavior of any utilities and functions on z/OS XL C/C++ is unpredictable. For example, if you are using charmaps such as Turkish IBM-1026 or Japanese IBM-290, where the characters encoded vary from the encoding in Table 349 on page 956, you may get unpredictable results with the utilities and functions.

#### Variants

Characters for which encoding may vary from one EBCDIC charmap file to another. Only the following characters are allowed in this group:

```

<backslash>
<right-brace>
<left-brace>
<right-square-bracket>
<left-square-bracket>
<circumflex>
<tilde>
<exclamation-mark>
<number-sign>
<vertical-line>
<dollar-sign>
<commercial-at>
<grave-accent>

```

The default EBCDIC encoding of each variant character is shown by a hexadecimal value in parentheses in Table 349 on page 956. It is equivalent to the encoding in code page 1047.

The charmap file is divided into two main sections:

1. the charmap section, or CHARMAP
2. the character set identifier section, or CHARSETID

The following definitions can precede the two sections listed above. Each consists of the symbol shown in the following list, starting in column 1, including the surrounding brackets, followed by one or more <blank>s, followed by the value to be assigned to the symbol.

**<code\_set\_name>**

The string literal containing the name of the coded character set name (IBM-1047, IBM-273, etc.)

**<mb\_cur\_max>**

the maximum number of bytes in a multibyte character which can be set to a value between 1 and 4. EBCDIC locales have `mb_cur_max` settings of either 1 or 4. ASCII locales have `mb_cur_max` settings of 1, 2 or 3.

If it is 1, each character in the character set defined in this charmap is encoded by a one-byte value. If it is 4, each character in the character set defined in this charmap is encoded by a one-, two-, three-, or four-byte value. If it is not specified, the default value of 1 is assumed. If a value of other than 1 or 4 is specified for an EBCDIC locale, a warning message is issued and the default value of 1 is assumed.

For ASCII locales `mb_cur_max` is defined as 1, 2 or 3. The value 1 means the same as for EBCDIC locales, while the values 2 and 3 mean 2 and 3 bytes per character respectively.

**<mb\_cur\_min>**

The minimum number of bytes in a multibyte character. Can be set to 1 only. If a value of other than 1 is specified, a warning message is issued and the default value of 1 is assumed.

**<escape\_char>**

Specifies the escape character that is used to specify hexadecimal or octal notation for numeric values. It defaults to the hexadecimal value `0xe0`, which represents the `\` character in the coded character set IBM-1047. For portability among the EBCDIC based systems, the escape character has been redefined to the `/` or `<slash>` character in all IBM-supplied charmap files, with the following statement:

```
<escape_char> /
```

**<comment\_char>**

Denotes the character chosen to indicate a comment within a charmap file. It defaults to the hexadecimal value 0x7b, which represents the # character in the coded character set IBM-1047. For portability among the EBCDIC based systems, the comment character has been redefined to the % or <percent-sign> character in all IBM-supplied charmap files, with the following statement:

```
<comment_char> %
```

**<shift\_out>**

Specifies the value of the shift-out control character that indicates the start of a string of double-byte characters. If specified, it must be the value of the EBCDIC shift-out (SO) character (hexadecimal value 0x0e). It is ignored if the <mb\_cur\_max> value is 1.

**<shift\_in>**

Specifies the value of the shift-in control character that indicates the end of a string of double-byte characters. If specified, it must be the value of the EBCDIC shift-in (SI) character (hexadecimal value 0x0f). It is ignored if the <mb\_cur\_max> value is 1.

## The CHARMAP section

The CHARMAP section defines the values for the symbolic names representing characters in the coded character set. Each charmap file must define at least the portable character set. The character symbolic names or alternate symbolic names (or both) must be used to define the portable character set. These are shown in Table 349 on page 956.

Additional characters can be defined by the user with symbolic character names.

The CHARMAP section starts with the line containing the keyword CHARMAP, and ends with the line containing the keywords END CHARMAP. CHARMAP and END CHARMAP must both start in column one.

The character set mapping definitions are all the lines between the first and last lines of the CHARMAP section. The formats of the character set mappings for this section are as follows:

```
"%s %s %s\n", <symbolic-name>, <encoding>, <comments>
"%s...%s %s %s\n", <symbolic-name>, <symbolic-name>, <encoding>, <comments>
```

The first format defines a single symbolic name and a corresponding encoding. A symbolic name is one or more characters with visible glyphs, enclosed between angle brackets.

For reasons of portability, a symbolic name should include only the characters from the invariant part of the portable character set. If you use variant characters or decimal or hexadecimal notation in a symbolic name, the symbolic name will not be portable. A character following an escape character is interpreted as itself; for example, the sequence <\\> represents the symbolic name \> enclosed within angle brackets, where the backslash \ is the escape character. If / is the escape character, the sequence <///> represents the symbolic name />. In the supplied charmap files, the escape character has been redefined to the forward slash /.

The second format defines a group of symbolic names associated with a range of values. The two symbolic names are comprised of two parts, a prefix and suffix. The prefix consists of zero or more non-numeric invariant visible glyph characters and is the same for both symbolic names. The suffix consists of a positive decimal integer. The suffix of the first symbolic name must be less than or equal to the suffix of the second symbolic name. As an example, <j0101>...<j0104> is interpreted as the symbolic names <j0101>,<j0102>,<j0103>,<j0104>. The common prefix is 'j' and the suffixes are '0101' and '0104'.

The encoding part can be written in one of two forms:

```
<escape-char><number>                (single byte value)
<escape-char><number><escape-char><number> (double byte value)
```

The number can be written using octal, decimal, or hexadecimal notation. Decimal numbers are written as a 'd' followed by 2 or 3 decimal digits. Hexadecimal numbers are written as an 'x' followed by 2 hexadecimal digits. An octal number is written with 2 or 3 octal digits. As an example, the single byte value x1F could be written as '\37', '\x1F', or '\d31'.

The double byte value of 0x1A1F could be written as '\32\37', '\x1A\x1F', or '\d26\d31'.

In lines defining ranges of symbolic names, the encoded value is the value for the first symbolic name in the range (the symbolic name preceding the ellipsis). Subsequent names defined by the range have encoding values in increasing order.

When constants are concatenated for multibyte character values, they must be of the same type, and are interpreted in byte order from first to last with the least significant byte of the multibyte character specified by the last constant. Each value is then prepended by the byte value of <shift\_out> and appended with the byte value of <shift\_in>. Such a string represents one EBCDIC multibyte character, as the following example shows:

```
<escape_char> /
<comment_char> %
<mb_cur_max> 4
<mb_cur_min> 1
<shift-out> /x0e
<shift-in> /x0f
CHARMAP
% many definition lines
<j0101>...<j0104> /d129/d254
%many definition lines
END CHARMAP
```

is interpreted as:

```
<j0101> /d129/d254
<j0102> /d129/d255
<j0103> /d130/d0
<j0104> /d130/d1
```

It produces four 4-byte long multibyte EBCDIC characters:

```
<j0101> x0Ex81xFEx0F
<j0102> x0Ex81xFFx0F
<j0103> x0Ex82x00x0F
<j0104> x0Ex82x01x0F
```

## The CHARSETID section

The character set identifier section of the charmap file maps the symbolic names defined in the CHARMAP section to a character set identifier.

**Note:** The two functions `csid()` and `wcsid()` query the locales and return the character set identifier for a given character. This information is not currently used by any other library function.

The CHARSETID section starts with a line containing the keyword CHARSETID, and ends with the line containing the keywords END CHARSETID. Both CHARSETID and END CHARSETID must begin in column 1. The lines between the first and last lines of the CHARSETID section define the character set identifier for the defined coded character set.

The character set identifier mappings are defined as follows:

```
"%s %c", <symbolic-name>, <value>
"%c %c", <value>, <value>
"%s...%s %c", <symbolic-name>, <symbolic-name>, <value>
"%c...%c %c", <value>, <value>, <value>
"%s...%c %c", <symbolic-name>, <value>, <value>
"%c...%s %c", <value>, <symbolic-name>, <value>
```

The individual characters are specified by the symbolic name or the value. The group of characters are specified by two symbolic names or by two numeric values (or combination) separated by an ellipsis (...). The interpretation of ranges of values is the same as specified in the CHARMAP section. The character set identifier is specified by a numeric value.

```
<comment_char>      %
<escape_char>      /
<code_set_name>     "IBM-930"
<mb_cur_max>       4
<mb_cur_min>       1
<shift_out>        /x0e
<shift_in>         /x0f

%
%      CHARMAP
%

CHARMAP
...
<j0110>              /x42/x5a
<j0111>...<j0112>   /x43/xbe
<judc2001>...<judc2094> /x72/x8d
...
END CHARMAP

%
%      CHARSETID
%

CHARSETID
...
<j0110>              1
<j0111>...<j0112>   1
<judc2001>...<judc2094> 3
...
END CHARSETID
```

---

## Locale source files

Locales are defined through the specification of a locale definition file. The locale definition contains one or more distinct locale category source definitions and not more than one definition of any category. Each category controls specific aspects of the cultural environment. A category source definition is either the explicit definition of a category or the copy directive, which indicates that the category definition should be copied from another locale definition file.

ASCII locales must be specified using only the characters from the portable character set, and all character references must be symbolic names, not explicit code point values.

The definition file is composed of an optional definition section for the escape and comment characters to be used, followed by the category source definitions. Comment lines and blank lines can appear anywhere in the locale definition file. If the escape and comment characters are not defined, default code points are used (xE0 for the escape character and x7B for the comment character, respectively). The definition section consists of the following optional lines, where <character> in both cases is a single-byte character to be used:

```
escape_char    <character>
comment_char   <character>
```

For example, the following statement defines the escape character in this file to be '/' (the <slash> character).

```
escape_char    /
```

Locale definition files passed to the `localedef` utility are assumed to be in coded character set IBM-1047.

To ensure portability among EBCDIC systems, you should redefine these characters to characters from the invariant part of the portable character set. The suggested redefinition is:

```
escape_char    /
comment_char   %
```

This suggested redefinition is used in all locale definition files supplied by IBM. For reasons of portability, you should use the suggested redefinition in all your customized locale definition files. See Chapter 61, "Customizing a locale," on page 1005 for information about customizing locales. These two redefinitions should be placed in the first lines of the locale definition source file, before any of the redefined characters are used.

Each category source definition consists of a category header, a category body, and a category trailer, in that order.

### category header

consists of the keyword naming the category. Each category name starts with the characters `LC_`. The following category names are supported: `LC_CTYPE`, `LC_COLLATE`, `LC_NUMERIC`, `LC_MONETARY`, `LC_TIME`, `LC_MESSAGES`, `LC_TOD`, and `LC_SYNTAX`.

The `LC_TOD` and `LC_SYNTAX` categories, if present, must be the last two categories in the locale definition file.

**category body**

consists of one or more lines describing the components of the category. Each component line has the following format:

```
<identifier> <operand1>
<identifier> <operand1>;<operand2>;...;<operandN>
```

<identifier> is a keyword that identifies a locale element, or a symbolic name that identifies a collating element. <operand> is a character, collating element, or string literal. Escape sequences can be specified in a string literal using the <escape\_character>. If multiple operands are specified, they must be separated by semicolons. White space can be before and after the semicolons.

**category trailer**

consists of the keyword END followed by one or more <blank>s and the category name of the corresponding category header.

Figure 246 is an example of locale source containing the header, body, and trailer.

```
escape_char /
comment_char %
%
% Here is a simple locale definition file consisting of one
% category source definition, LC_CTYPE.
%
LC_CTYPE
upper <A>;...;<Z>
END LC_CTYPE
```

Figure 246. Example locale source containing header, body, and trailer

You do not have to define each category. Where category definitions are absent from the locale source, default definitions are used.

In each category, the keyword copy followed by a string specifies the name of an existing locale to be used as the source for the definition of this category.

If the locale is not found, an error is reported and no locale output is created.

For the batch (EDC(X)LDEF proc) and TSO (LOCALDEF) commands, the name must be the member name of a partitioned data set allocated to the EDCL0CL DD statement. For the UNIX System Services localdef command, the copy keyword specifies the path name of the source file.

You can continue a line in a locale definition file by placing an escape character as the last character on the line. This continuation character is discarded from the input. Even though there is no limitation on the length of each line, for portability reasons it is suggested that each line be no longer than 2048 characters (bytes). There is no limit on the accumulated length of a continued line. You cannot continue comment lines on a subsequent line by using an escaped <newline>.

Individual characters, characters in strings, and collating elements are represented using symbolic names, as defined below. Characters can also be represented as the characters themselves, or as octal, hexadecimal, or decimal constants. If you use non-symbolic notation, the resultant locale definition file may not be portable



among systems and environments. The left angle bracket (<) is a reserved symbol, denoting the start of a symbolic name; if you use it to represent itself, you must precede it with the escape character.

The following rules apply to the character representation:

1. A character can be represented by a symbolic name, enclosed within angle brackets. The symbolic name, including the angle brackets, must exactly match a symbolic name defined in the charmap file. The symbolic name is replaced by the character value determined from the value associated with the symbolic name in the charmap file.

The use of a symbolic name not found in the charmap file constitutes an error, unless the name is in the category LC\_CTYPE or LC\_COLLATE, in which case it constitutes a warning. Use of the escape character or right angle bracket within a symbolic name is invalid unless the character is preceded by the escape character. For example:

**<c>;<c-cedilla>**

specifies two characters whose symbolic names are "c" and "c-cedilla"

**"<M><a><y>"**

specifies a 3-character string composed of letters represented by symbolic names "M", "a", and "y"

**"<a><\>"**

specifies a 2-character string composed of letters represented by symbolic names "a" and ">" (assuming the escape character is \)

If the character represented by the symbolic name is a multibyte character defined by 2 byte values in the charmap file, and the shift-out and shift-in characters are defined, the value is enclosed within shift-out and shift-in characters before the localedef utility processes it any further.

2. A character can represent itself. Within a string, the double quotation mark, the escape character, and the left angle bracket must be escaped (preceded by the escape character) to be interpreted as the characters themselves. For example:

**c** 'c' character represented by itself

**"may"** represents a 3-character string, each character within the string represented by itself

**"%%%">"**

represents the three character long string "%">", where the escape character is defined as %

3. A character can be represented as an octal constant. An octal constant is specified as the escape character followed by two or more octal digits. Each constant represents a byte value.

For example: \131 "\212\129\168" \16\66\193\17

4. A character can be represented as a hexadecimal constant. A hexadecimal constant is specified as the escape character, followed by an x, followed by two or more hexadecimal digits. Each constant represents a byte value.

For example: \x83 "\xD4\x81\xA8"

5. A character can be represented as a decimal constant. A decimal constant is specified as the escape character followed by a d followed by two or more decimal digits. Each constant represents a byte value.

For example: \d131 "\d212\d129\d168" \d14\d66\d193\d15

For multibyte characters, the entire encoding sequence, including the shift-out and shift-in characters, must be present. Otherwise, the sequence of bytes not enclosed between the shift-out and shift-in characters are interpreted as a sequence of single byte characters.

Multibyte characters can be represented by concatenating constants specified in byte order with the last constant specifying the least significant byte of the character. If the sequence of octal, hexadecimal, or decimal constants is to represent a multibyte character, it must be enclosed in shift-out and shift-in constants. For example: `\x0e\x42\xC1\x0f`

## LC\_CTYPE category

This category defines character classification, case conversion, and other character attributes. In this category, you can represent a series of characters by using three adjacent periods as an ellipsis symbol (`...`). An ellipsis is interpreted as including all characters with an encoded value higher than the encoded value of the character preceding the ellipsis and lower than the encoded value following the ellipsis.

An ellipsis is valid within a single encoded character set. For example, `\x30;...;\x39;` includes in the character class all characters with encoded values from X'30' to X'39'.

The keywords recognized in the LC\_CTYPE category are listed below. In the descriptions, the term "automatically included" means that it is not an error either to include or omit any of the referenced characters; they are assumed by default even if the entire keyword is missing and accepted if present. If a keyword is specified without any arguments, the default characters are assumed.

When a character is automatically included, it has an encoded value dependent on the charmap file in effect. If no charmap file is specified, the encoding of the encoded character set IBM-1047 is assumed.

**copy** Specifies the name of an existing locale to be used as the source for the definition of this category. If this keyword is specified, no other keywords are present in this category. If the locale is not found, an error is reported and no locale output is created. The copy keyword cannot specify a locale that also specifies the copy keyword for the same category.

### **charclass**

Defines one or more locale-specific character class names as strings separated by semicolons. Each named character class can then be defined subsequently in the LC\_CTYPE definition. A character class name consists of at least one and at most {CHARCLASS\_NAME\_MAX} bytes of alphanumeric characters from the portable filename character set. The first character of a character class name cannot be a digit. The name cannot match any of the LC\_CTYPE keywords defined in this document.

**upper** Defines characters to be classified as uppercase letters. No character defined for the keywords `cntrl`, `digit`, `punct`, or `space` can be specified. The uppercase letters A through Z are automatically included in this class. The `isupper()` and `iswupper()` functions test for any character and wide character, respectively, included in this class.

**lower** Defines characters to be classified as lowercase letters. No character defined for the keywords `cntrl`, `digit`, `punct`, or `space` can be specified. The lowercase letters a through z are automatically included in this class.

The `islower()` and `iswlower()` functions test for any character and wide character, respectively, included in this class.

- alpha** Defines characters to be classified as letters. No character defined for the keywords `cntrl`, `digit`, `punct`, or `space` can be specified. Characters classified as either `upper` or `lower` are automatically included in this class. The `isalpha()` and `iswalpha()` functions test for any character or wide character, respectively, included in this class.
- digit** Defines characters to be classified as numeric digits. Only the digits 0, 1, 2, 3, 4, 5, 6, 7, 8, 9. can be specified. If they are, they must be in contiguous ascending sequence by numerical value. The digits 0 through 9 are automatically included in this class. The `isdigit()` and `iswdigit()` functions test for any character or wide character, respectively, included in this class.
- space** Defines characters to be classified as whitespace characters. No character defined for the keywords `upper`, `lower`, `alpha`, `digit`, or `xdigit` can be specified for `space`. The characters `<space>`, `<form-feed>`, `<newline>`, `<carriage-return>`, `<horizontal-tab>`, and `<vertical-tab>`, and any characters defined in the class `blank` are automatically included in this class. The functions `isspace()` and `iswspace()` test for any character or wide character, respectively, included in this class.
- cntrl** Defines characters to be classified as control characters. No character defined for the keywords `upper`, `lower`, `alpha`, `digit`, `punct`, `graph`, `print`, or `xdigit` can be specified for `cntrl`. The functions `iscntrl()` and `iswcntrl()` test for any character or wide character, respectively, included in this class.
- punct** Defines characters to be classified as punctuation characters. No character defined for the keywords `upper`, `lower`, `alpha`, `digit`, `cntrl`, or `xdigit`, or as the `<space>` character, can be specified. The functions `ispunct()` and `iswpunct()` test for any character or wide character, respectively, included in this class.
- graph** Defines characters to be classified as printing characters, not including the `<space>` character. Characters specified for the keywords `upper`, `lower`, `alpha`, `digit`, `xdigit`, and `punct` are automatically included. No character specified in the keyword `cntrl` can be specified for `graph`. The functions `isgraph()` and `iswgraph()` test for any character or wide character, respectively, included in this class.
- print** Defines characters to be classified as printing characters, including the `<space>` character. Characters specified for the keywords `upper`, `lower`, `alpha`, `digit`, `xdigit`, `punct`, and the `<space>` character are automatically included. No character specified in the keyword `cntrl` can be specified for `print`. The functions `isprint()` and `iswprint()` test for any character or wide character, respectively, included in this class.
- xdigit** Defines characters to be classified as hexadecimal digits. Only the characters defined for the class `digit` can be specified, in contiguous ascending sequence by numerical value, followed by one or more sets of six characters representing the hexadecimal digits 10 through 15, with each set in ascending order (for example, A, B, C, D, E, F, a, b, c, d, e, f). The digits 0 through 9, the uppercase letters A through F, and the lowercase letters a through f are automatically included in this class. The functions `isxdigit()` and `iswxdigit()` test for any character or wide character, respectively, included in this class.

**blank** Defines characters to be classified as blank characters. The characters `<space>` and `<tab>` are automatically included in this class. The functions `isblank()` and `iswblank()` test for any character or wide character, respectively, included in this class.

**toupper**

Defines the mapping of lowercase letters to uppercase letters. The operand consists of character pairs, separated by semicolons. The characters in each character pair are separated by a comma; the pair is enclosed in parentheses. The first character in each pair is the lowercase letter, and the second is the corresponding uppercase letter. Only characters specified for the keywords `lower` and `upper` can be specified for `toupper`. The lowercase letters `a` through `z`, their corresponding uppercase letters `A` through `Z`, are automatically in this mapping, but only when the `toupper` keyword is omitted from the locale definition. It affects the behavior of the `toupper()` and `towupper()` functions for mapping characters and wide characters, respectively.

**tolower**

Defines the mapping of uppercase letters to lowercase letters. The operand consists of character pairs, separated by semicolons. The characters in each character pair are separated by a comma; the pair is enclosed by parentheses. The first character in each pair is the uppercase letter, and the second is its corresponding lowercase letter. Only characters specified for the keywords `lower` and `upper` can be specified. If the `tolower` keyword is omitted from the locale definition, the mapping is the reverse mapping of the one specified for the `toupper`. The `tolower` keyword affects the behavior of the `tolower()` and `towlower()` functions for mapping characters and wide characters, respectively.

You may define additional character classes using your own keywords. A maximum of 31 classes are supported in total: the 12 standard classes, and up to 19 user-defined classes. The defined classes affect the behavior of `wctype()` and `iswctype()` functions.

Figure 247 on page 970 is an example of the definition of the `LC_CTYPE` category.

```

escape_char      /
comment_char    %

%%%%%%%%%%%%
LC_CTYPE
%%%%%%%%%%%%
% upper letters are A-Z by default plus the three defined below
upper  <A-acute.>;<A-grave.>;<C-acute.>

% lower case letters are a-z by default plus the three defined below
lower  <a-acute>;<a_grave><c-acute>

% space characters are default 6 characters plus the one defined below
space  <hyphen-minus>

cntrl  <alert>;<backspace>;<tab>;<newline>;<vertical-tab>;/
       <form-feed>;<carriage-return>;<NUL>;/
       <SO>;<SI>

% default graph, print,punct, digit, xdigit, blank classes

% toupper mapping defined only for the following three pairs
toupper (<a-acute>,<A-acute>);/
        (<a-grave>,<A-grave>);/
        (<c-acute>,<C-acute>);

% default upper to lower case mapping

% user defined class
myclass <e-ogonek>;<E-ogonek>

END LC_CTYPE

```

Figure 247. Example LC\_CTYPE definition

## LC\_COLLATE category

A collation sequence definition defines the relative order between collating elements (characters and multicharacter collating elements) in the locale. This order is expressed in terms of collation values. It assigns each element one or more collation values (also known as collation weights). The collation sequence definition is used by regular expressions, pattern matching, and sorting and collating functions. The following capabilities are provided:

1. **Multicharacter collating elements.** Specification of multicharacter collating elements (sequences of two or more characters to be collated as an entity).
2. **User-defined ordering of collating elements.** Each collating element is assigned a collation value defining its order in the character (or basic) collation sequence. This ordering is used by regular expressions and pattern matching, and unless collation weights are explicitly specified, also as the collation weight to be used in sorting.
3. **Multiple weights and equivalence classes.** Collating elements can be assigned 1 to 6 collating weights for use in sorting. The first weight is referred to as the primary weight.
4. **One-to-many mapping.** A single character is mapped into a string of collating elements.
5. **Many-to-many substitution.** A string of one or more characters are mapped to another string (or an empty string). The character or characters are ignored for collation purposes.

**Note:** This is an IBM extension; therefore, locales that use it may not be portable to localedef tools developed by other vendors.

6. **Equivalence class definition.** Two or more collating elements have the same collation value (primary weight).
7. **Ordering by weights.** When two strings are compared to determine their relative order, the two strings are first broken up into a series of collating elements. Each successive pair of elements is compared according to the relative primary weights for the elements. If they are equal, and more than one weight is assigned, then the pairs of collating elements are compared again according to the relative subsequent weights, until either two collating elements are not equal or the weights are exhausted.

## Collating rules

Collation rules consist of an ordered list of collating order statements, ordered from lowest to highest. The <NULL> character is considered lower than any other character. The ellipsis symbol ("...") is a special collation order statement. It specifies that a sequence of characters collate according to their encoded character values. It causes all characters with values higher than the value of the <collating identifier> in the preceding line, and lower than the value for the <collating identifier> on the following line, to be placed in the character collation order between the previous and the following collation order statements in ascending order according to their encoded character values.

The use of the ellipsis symbol ties the definition to a specific coded character set and may preclude the definition from being portable among implementations.

The ellipsis symbol can precede or succeed the ellipsis symbol and may also have weights on the same line.

A collating order statement describes how a collating identifier is weighted.

Each <collating-identifier> consists of a character, <collating-element>, <collating-symbol>, or the special symbol UNDEFINED. The order in which collating elements are specified determines the character order sequence, such that each collating element is considered lower than the elements following it. The <NULL> character is considered lower than any other character. Weights are expressed as characters, <collating-symbol>s, <collating-element>s, or the special symbol IGNORE. A single character, a <collating-symbol>, or a <collating-element> represents the relative position in the character collating sequence of the character or symbol, rather than the character or characters themselves. Thus rather than assigning absolute values to weights, a particular weight is expressed using the relative "order value" assigned to a collating element based on its order in the character collation sequence.

A <collating-element> specifies multicharacter collating elements, and indicates that the character sequence specified by the <collating-element> is to be collated as a unit and in the relative order specified by its place.

A <collating-symbol> can define a position in the relative order for use in weights.

The <collating-symbol> UNDEFINED is interpreted as including all characters not specified explicitly. Such characters are inserted in the character collation order at the point indicated by the symbol, and in ascending order according to their encoded character values. If no UNDEFINED symbol is specified, and the current coded character set contains characters not specified in this clause, the localedef utility issues a warning and places such characters at the end of the character collation order.

The syntax for a collation order statement is:

```
<collating-identifier> <weight1>;<weight2>;...;<weightn>
```

Collation of two collating identifiers is done by comparing their relative primary weights. This process is repeated for successive weight levels until the two identifiers are different, or the weight levels are exhausted. The operands for each collating identifier define the primary, secondary, and subsequent relative weights for the collating identifier. Two or more collating elements can be assigned the same weight. If two collating identifiers have the same primary weight, they belong to the same *equivalence class*.

The special symbol IGNORE as a weight indicates that when strings are compared using the weights at the level where IGNORE is specified, the collating element should be ignored, as if the string did not contain the collating element. In regular expressions and pattern matching, all characters that are IGNORED in their primary weight form an equivalence class.

All characters specified by an ellipsis are assigned unique weights, equal to the relative order of the characters. Characters specified by an explicit or implicit UNDEFINED special symbol are assigned the same primary weight (they belong to the same equivalence class).

One-to-many mapping is indicated by specifying two or more concatenated characters or symbolic names. For example, if the character "<ezet>" is given the string "<s><s>" as a weight, comparisons are performed as if all occurrences of the character <ezet> are replaced by <s><s> (assuming <s> has the collating weight <s>). If it is desirable to define <ezet> and <s><s> as an equivalence class, then a collating element must be defined for the string "ss".

If no weight is specified, the collating identifier is interpreted as itself. For example, the order statement

```
<a> <a>
```

is equivalent to

```
<a>
```

## Collating keywords

The following keywords are recognized in a collation sequence definition.

**copy** Specifies the name of an existing locale to be used as the source for the definition of this category. If this keyword is specified, no other keyword shall be present in this category. If the locale is not found, an error is reported and no locale output is created. The copy keyword cannot specify a locale that also specifies the copy keyword for the same category.

### collating-element

Defines a collating-element symbol representing a multicharacter collating element. This keyword is optional. In addition to the collating elements in the character set, the collating-element keyword can be used to define multicharacter collating elements. The syntax is:

```
"collating-element %s from \"%s\"", <collating-element>, <string>
```

The <collating-element> should be a symbolic name enclosed between angle brackets (< and >), and should not duplicate any symbolic name in the current charmap file (if any), or any other symbolic name defined in this collation definition. The string operand is a string of two or more



characters that collate as an entity. A `<collating-element>` defined with this keyword is only recognized within the `LC_COLLATE` category. For example:

```
collating-element <ch> from "<c><h>"
collating-element <e-acute> from "<acute><e>"
collating-element <l1> from "l1"
```

### **collating-symbol**

Defines a collating symbol for use in collation order statements.

The `collating-symbol` keyword defines a symbolic name that can be associated with a relative position in the character order sequence. While such a symbolic name does not represent any collating element, it can be used as a weight. This keyword is optional.

This construct can define symbols for use in collation sequence statements, between the `order_start` and `order_end` keywords. The syntax is:

```
"collating-symbol \%s\"", <collating-symbol>
```

The `<collating-symbol>` must be a symbolic name, enclosed between angle brackets (`<` and `>`), and should not duplicate any symbolic name in the current charmap file (if any), or any other symbolic name defined in this collation definition. A `<collating-symbol>` defined with this keyword is only recognized within the `LC_COLLATE` category.

For example:

```
collating-symbol <UPPER_CASE>
collating-symbol <HIGH>
```

### **substitute**

The `substitute` keyword defines a substring substitution in a string to be collated. This keyword is optional. The following operands are supported with the `substitute` keyword:

```
"substitute %s with \%s\"", <regular-expr>, <replacement>
```

The first operand is treated as a basic regular expression. The replacement operand consists of zero or more characters and regular expression back-references (for example, `\1` through `\9`). The back-references consist of the backslash followed by a digit from 1 to 9. If the backslash is followed by two or three digits, it is interpreted as an octal constant.

When strings are collated according to a collation definition containing `substitute` statements, the collation behaves as if occurrences of substrings matching the basic regular expression are replaced by the replacement string, before the strings are compared based on the specified collation sequence. Ranges in the regular expression are interpreted according to the current character collation sequence and character classes according to the character classification specified by the `LC_CTYPE` environment variable at collation time. If more than one `substitute` statement is present in the collation definition, the collation process behaves as if the `substitute` statements are applied to the strings in the order they occur in the source definition. The substitution for the `substitute` statements are processed before any substitutions for one-to-many mappings. The support of the "substitute" keyword is an IBM z/OS XL C/C++ extension to the POSIX standard.

**Note:** This is an IBM extension; therefore, locales that use it may not be portable to localedef tools developed by other vendors.



**order\_start**

Define collating rules. This statement is followed by one or more collation order statements, assigning character collation values and collation weights to collating elements.

The `order_start` keyword must precede collation order entries. It defines the number of weights for this collation sequence definition and other collation rules. The syntax of the `order_start` keyword is:

```
order_start <sort-rule1>;<sort-rule1>;...;<sort-rulen>
```

The operands of the `order_start` keyword are optional. If present, the operands define rules to be applied when strings are compared. The number of operands define how many weights each element is assigned; if no operands are present, one forward operand is assumed. If any is present, the first operand defines rules to be applied when comparing strings using the first (primary) weight; the second when comparing strings using the second weight, and so on. Operands are separated by semicolons (;). Each operand consists of one or more collation directives separated by commas (,). If the number of operands exceeds the limit of 6, the `localedef` utility issues a warning message.

The following directives are supported:

**forward**

specifies that comparison operations for the weight level proceed from the start of the string towards its end.

**backward**

specifies that comparison operations for the weight level proceed from the end of the string toward its beginning.

**no-substitute**

no substitution is performed, such that the comparison is based on collation values for collating elements before any substitution operations are performed.

**Notes:**

1. This is an IBM extension; therefore, locales that use it may not be portable to `localedef` tools developed by other vendors.
2. When the `no-substitute` keyword is specified, one-to-many mappings are ignored.

**position**

specifies that comparison operations for the weight level must consider the relative position of non-IGNORED elements in the strings. The string containing a non-IGNORED element after the fewest IGNORED collating elements from the start of the comparison collates first. If both strings contain a non-IGNORED character in the same relative position, the collating values assigned to the elements determine the order. If the strings are equal, subsequent non-IGNORED characters are considered in the same manner.

**order\_end**

The collating order entries are terminated with an `order_end` keyword.

Figure 248 on page 975 is an example of an LC\_COLLATE category.

```

LC_COLLATE
% ARTIFICIAL COLLATE CATEGORY

% collating elements
1 collating-element <ch> from "<c><h>"
  collating-element <Ch> from "<C><h>"
  collating-element <eszet> from "<s><z>"

%collating symbols for relative order definition

2 collating-symbol <LOW>
  collating-symbol <UPPER-CASE>
  collating-symbol <LOWER-CASE>
  collating-symbol <NONE>

3 order_start forward;backward;forward
4 <NONE>
  <LOW>
  <UPPER-CASE>
  <LOWER-CASE>

5 UNDEFINED IGNORE;IGNORE;IGNORE

<space>
6 ...
  <quotation-mark>
7 <a> <a>;<NONE>;<LOWER-CASE>
10 <a-acute> <a>;<a-acute>;<LOWER-CASE>
11 <a-grave> <a>;<a-grave>;<LOWER-CASE>
8 <A> <a>;<NONE>;<UPPER-CASE>
11 <A-acute> <a>;<a-acute>;<UPPER-CASE>
11 <A-grave> <a>;<a-grave>;<UPPER-CASE>
11 <ch> <ch>;<NONE>;<LOWER-CASE>
11 <Ch> <ch>;<NONE>;<UPPER-CASE>
9 <s> <s>;<s>;<LOWER-CASE>
12 <eszet> "<s><s>";"<eszet><s>";<LOWER-CASE>
9 <z> <z>;<NONE>;<LOWER-CASE>

order_end

```

Figure 248. Example LC\_COLLATE definition

The example is interpreted as follows:

1. collating elements
  - character <c> followed by <h> collate as one entity named <ch>
  - character <C> followed by <h> collate as one entity named <Ch>
  - character <s> followed by <z> collate as one entity named <eszet>
2. collating symbols <LOW>, <UPPER-CASE>, <LOWER-CASE> and <NONE> are defined to be used in relative order definition
3. up to 3 string comparisons are defined:
  - first pass starts from the beginning of the strings
  - second pass starts from the end of the strings, and
  - third pass starts from the beginning of the strings
4. the collating weights are defined such that
  - <LOW> collates before <UPPER-CASE>,
  - <UPPER-CASE> collates before <LOWER-CASE>,
  - <LOWER-CASE> collates before <NONE>;
5. all characters for which collation is not specified here are ordered after <NONE>, and before <space> in ascending order according to their encoded values
6. all characters with an encoded value larger than the encoded value of <space> and lower than the encoded value of <quotation-mark> in the current encoded character set, collate in ascending order according to their values;

7. <a> has a:
  - primary weight of <a>,
  - secondary weight <NONE>,
  - tertiary weight of <LOWER-CASE>,
8. <A> has a:
  - primary weight of <a>,
  - secondary weight of <NONE>,
  - tertiary weight of <UPPER-CASE>,
9. the weights of <s> and <z> are determined in a similar fashion to <a> and <A>.
10. <a-acute> has a:
  - primary weight of <a>,
  - secondary weight of <a-acute> itself,
  - tertiary weight of <LOWER-CASE>,
11. the weights of <a-grave>, <A-acute>, <A-grave>, <ch> and <Ch> are determined in a similar fashion to <a-acute>.
12. <eszet> has a:
  - primary weight determined by replacing each occurrence of <eszet> with the sequence of two <s>'s and using the weight of <s>,
  - secondary weight determined by replacing each occurrence of <eszet> with the sequence of <eszet> and <s> and using their weights,
  - tertiary weight is the relative position of <LOWER-CASE>.

### Comparison of strings

Compare the strings `s1="aAch"` and `s2="AaCh"` using the above `LC_COLLATE` definition:

1. `s1=> "aA<ch>"`, and `s2=> "Aa<Ch>"`
2. first pass:
  - a. substitute the elements of the strings with their primary weights: `s1=> "<a><a><ch>"`, `s2=> "<a><a><ch>"`
  - b. compare the two strings starting with the first element — they are equal.
3. second pass:
  - a. substitute the elements of the strings with their secondary weights: `s1=> "<NONE><NONE><NONE>"`, `s2=> "<NONE><NONE><NONE>"`
  - b. compare the two strings from the last element to the first — they are equal.
4. third pass:
  - a. substitute the elements of the strings with their third level weights:
   
`s1=> "<LOWER-CASE><UPPER-CASE><LOWER-CASE>"`,
   
`s2=> "<UPPER-CASE><LOWER-CASE><UPPER-CASE>"`,
  - b. compare the two strings starting from the beginning of the strings: `s2` compares lower than `s1`, because `<UPPER-CASE>` is before `<LOWER-CASE>`.

Compare the strings `s1="áß"` and `s2="äss"`:

1. `s1=> "á<eszet>"` and `s2="äss"`;
2. first pass:
  - a. substitute the elements of the strings with their primary weights: `s1=> "<a><s><s>"`, `s2=> "<a><s><s>"`
  - b. compare the two strings starting with the first element — they are equal.
3. second pass:

- a. substitute the elements of the strings with their secondary weights: s1=>"<a-acute><eszet><s>", s2=>"<a-grave><s><s>"
- b. compare the two strings from the last element to the first — <s> is before <eszet>.

## LC\_MONETARY category

This category defines the rules and symbols used to format monetary quantities. The operands are strings or integers. The following keywords are supported:

**copy** Specifies the name of an existing locale to be used as the source for the definition of this category. If this keyword is specified, no other keyword should be present in this category. If the locale is not found, an error is reported and no locale output is created. The copy keyword cannot specify a locale that also specifies the copy keyword for the same category.

### **int\_curr\_symbol**

Specifies the international currency symbol. The operand is a four-character string, with the first three characters containing the alphabetic international currency symbol in accordance with those specified in ISO4217 *Codes for the Representation of Currency and Funds*. The fourth character is the character used to separate the international currency symbol from the monetary quantity.

The following value may also be specified, though it is not. If not defined, it defaults to the empty string ("").

### **currency\_symbol**

Specifies the string used as the local currency symbol. If not defined, it defaults to the empty string ("").

### **mon\_decimal\_point**

The string used as a decimal delimiter to format monetary quantities. If not defined it defaults to the empty string ("").

### **mon\_thousands\_sep**

Specifies the string used as a separator for groups of digits to the left of the decimal delimiter in formatted monetary quantities. If not defined, it defaults to the empty string ("").

### **mon\_grouping**

Defines the size of each group of digits in formatted monetary quantities. The operand is a sequence of integers separated by semicolons. Also, for compatibility, it may be a string of integers separated by semicolons. Each integer specifies the number of digits in each group, with the initial integer defining the size of the group immediately preceding the decimal delimiter, and the following integers defining the preceding groups. If the last integer is not -1, then the size of the previous group (if any) is used repeatedly for the rest of the digits. If the last integer is -1, then no further grouping is performed. If not defined, mon\_grouping defaults to -1 which indicates that no grouping. An empty string is interpreted as -1.

### **positive\_sign**

A string used to indicate a formatted monetary quantity with a non-negative value. If not defined, it defaults to the empty string ("").

### **negative\_sign**

Specifies a string used to indicate a formatted monetary quantity with a negative value. If not defined, it defaults to the empty string ("").

**int\_frac\_digits**

Specifies an integer representing the number of fractional digits (those to the right of the decimal delimiter) to be displayed in a formatted monetary quantity using `int_curr_symbol`. If not defined, it defaults to -1.

**frac\_digits**

Specifies an integer representing the number of fractional digits (those to the right of the decimal delimiter) to be displayed in a formatted monetary quantity using `currency_symbol`. If not defined, it defaults to -1.

**p\_cs\_precedes**

Specifies an integer set to 1 if the `currency_symbol` or `int_curr_symbol` precedes the value for a non-negative formatted monetary quantity, and set to 0 if the symbol succeeds the value. If not defined, it defaults to -1.

**p\_sep\_by\_space**

Specifies an integer set to 0 if no space separates the `currency_symbol` or `int_curr_symbol` from the value for a non-negative formatted monetary quantity, set to 1 if a space separates the symbol from the value, and set to 2 if a space separates the symbol and the string sign, if adjacent. If not defined, it defaults to -1.

**n\_cs\_precedes**

An integer set to 1 if the `currency_symbol` or `int_curr_symbol` precedes the value for a negative formatted monetary quantity, and set to 0 if the symbol succeeds the value. If not defined, it defaults to -1.

**n\_sep\_by\_space**

An integer set to 0 if no space separates the `currency_symbol` or `int_curr_symbol` from the value for a negative formatted monetary quantity, set to 1 if a space separates the symbol from the value, and set to 2 if a space separates the symbol and the string sign, if adjacent. If not defined, it defaults to -1.

**p\_sign\_posn**

An integer set to a value indicating the positioning of the `positive_sign` for a non-negative formatted monetary quantity. The following integer values are recognized; if not defined, it defaults to -1.

- 0      Parentheses surround the quantity and the `currency_symbol` or `int_curr_symbol`.
- 1      The sign string precedes the quantity and the `currency_symbol` or `int_curr_symbol`.
- 2      The sign string succeeds the quantity and the `currency_symbol` or `int_curr_symbol`.
- 3      The sign string immediately precedes the `currency_symbol` or `int_curr_symbol`.
- 4      The sign string immediately succeeds the `currency_symbol` or `int_curr_symbol`.

part of the POSIX standard.

- 5      Use `debit-sign` or `credit-sign` for `p_sign_posn` or `n_sign_posn`.

**n\_sign\_posn**

An integer set to a value indicating the positioning of the `negative_sign` for a negative formatted monetary quantity. The recognized values are the same as for `p_sign_posn`. If not defined, it defaults to -1.

**left\_parenthesis**

The symbol of the locale's equivalent of ( to form a negative-valued formatted monetary quantity together with right\_parenthesis. If not defined, it defaults to the empty string ("").

**Note:** This is an IBM-specific extension.

**right\_parenthesis**

The symbol of the locale's equivalent of ) to form a negative-valued formatted monetary quantity together with left\_parenthesis. If not defined, it defaults to the empty string ("");

**Note:** This is an IBM-specific extension.

**debit\_sign**

The symbol of locale's equivalent of DB to indicate a non-negative-valued formatted monetary quantity. If not defined, it defaults to the empty string ("");

**Note:** This is an IBM-specific extension.

**credit\_sign**

The symbol of locale's equivalent of CR to indicate a negative-valued formatted monetary quantity. If not defined, it defaults to the empty string ("");

**Note:** This is an IBM-specific extension.

**int\_p\_cs\_precedes**

Specifies an integer set to 1 if the int\_curr\_symbol precedes the value for a non-negative formatted monetary quantity, and set to 0 if the symbol succeeds the value. If not defined, it defaults to -1.

**int\_n\_cs\_precedes**

An integer set to 1 if the int\_curr\_symbol precedes the value for a negative formatted monetary quantity, and set to 0 if the symbol succeeds the value. If not defined, it defaults to -1.

**int\_p\_sep\_by\_space**

Specifies an integer set to 0 if no space separates the int\_curr\_symbol from the value for a non-negative formatted monetary quantity, set to 1 if a space separates the symbol from the value, and set to 2 if a space separates the symbol and the string sign, if adjacent. If not defined, it defaults to -1.

**int\_n\_sep\_by\_space**

An integer set to 0 if no space separates the int\_curr\_symbol from the value for a negative formatted monetary quantity, set to 1 if a space separates the symbol from the value, and set to 2 if a space separates the symbol and the string sign, if adjacent. If not defined, it defaults to -1.

**int\_p\_sign\_posn**

For a non-negative monetary quantity, the following integer values are recognized:

- 0        Parentheses surround the quantity and the int\_curr\_symbol.
- 1        The sign string precedes the quantity and the int\_curr\_symbol.
- 2        The sign string succeeds the quantity and int\_curr\_symbol.
- 3        The sign string immediately precedes the int\_curr\_symbol.

- 4 The sign string immediately succeeds the currency\_symbol or int\_curr\_symbol.

#### int\_n\_sign\_posn

For a negative monetary quantity, the following integer values are recognized:

- 0 Parentheses surround the quantity and the int\_curr\_symbol.
- 1 The sign string precedes the quantity and the int\_curr\_symbol.
- 2 The sign string succeeds the quantity and int\_curr\_symbol.
- 3 The sign string immediately precedes the int\_curr\_symbol.
- 4 The sign string immediately succeeds the currency\_symbol or int\_curr\_symbol.

Figure 249 is an example of the definition of the LC\_MONETARY category.

```

escape_char      /
comment_char     %

%%%%%%%%%%%%%%
LC_MONETARY
%%%%%%%%%%%%%%

int_curr_symbol  "<J><P><Y><space>"
currency_symbol  "<yen>"
mon_decimal_point "<period>"
mon_thousands_sep "<comma>"
mon_grouping     3
positive_sign    ""
negative_sign    "<hyphen-minus>"
int_frac_digits  0
frac_digits      0
p_cs_precedes    1
p_sep_by_space   0
n_cs_precedes    1
n_sep_by_space   0
p_sign_posn      1
n_sign_posn      1
debit_sign       "<D><B>"
credit_sign      "<C><R>"
left_parenthesis "<left-parenthesis>"
right_parenthesis "<right-parenthesis>"
int_p_cs_precedes -1
int_n_cs_precedes -1
int_p_sep_by_space -1
int_n_sep_by_space -1
int_p_sign_posn  -1
int_n_sign_posn  -1

END LC_MONETARY

```

Figure 249. Example LC\_MONETARY definition

## LC\_NUMERIC category

This category defines the rules and symbols used to format non-monetary numeric information. The operands are strings. The following keywords are recognized:

- copy** Specifies the name of an existing locale to be used as the source for the definition of this category. If this keyword is specified, no other keyword should be present in this category. If the locale is not found, an error is reported and no locale output is created. The copy keyword cannot specify a locale that also specifies the copy keyword for the same category.

**decimal\_point**

Specifies a string used as the decimal delimiter in numeric, non-monetary formatted quantities. This keyword cannot be omitted and cannot be set to the empty string.

**thousands\_sep**

Specifies a string containing the symbol that is used as a separator for groups of digits to the left of the decimal delimiter in numeric, non-monetary, formatted quantities.

**grouping**

Defines the size of each group of digits in formatted non-monetary quantities. The operand is a sequence of integers separated by semicolons. Also, for compatibility, it may be a string of integers separated by semicolons. Each integer specifies the number of digits in each group, with the initial integer defining the size of the group immediately preceding the decimal delimiter, and the following integers defining the preceding groups. If the last integer is not -1, then the size of the previous group (if any) is used repeatedly for the rest of the digits. If the last integer is -1, then no further grouping is performed. An empty string is interpreted as -1.

Figure 250 is an example of how to specify the LC\_NUMERIC category.

```

escape_char      /
comment_char    %

%%%%%%%%%%%%%%%%%%
LC_NUMERIC
%%%%%%%%%%%%%%%%%%

decimal_point    "<comma>"
thousands_sep   "<space>"
grouping         3

END LC_NUMERIC

```

Figure 250. Example LC\_NUMERIC definition

## LC\_TIME category

The LC\_TIME category defines the interpretation of the field descriptors used for parsing, then formatting, the date and time. The descriptors identify the replacement portion of the string, while the rest of a string is constant. The definition of descriptors is included in *z/OS XL C/C++ Runtime Library Reference*. All these descriptors can be used in the format specifier in the time formatting functions `strftime()`.

The following keywords are supported:

**copy** Specifies the name of an existing locale to be used as the source for the definition of this category. If this keyword is specified, no other keyword should be present in this category. If the locale is not found, an error is reported and no locale output is created. The copy keyword cannot specify a locale that also specifies the copy keyword for the same category.

**abday** Defines the abbreviated weekday names, corresponding to the `%a` field descriptor. The operand consists of seven semicolon-separated strings. The first string is the abbreviated name corresponding to Sunday, the second string corresponds to Monday, and so forth.



- day** Defines the full weekday names, corresponding to the %A field descriptor. The operand consists of seven semicolon-separated strings. The first string is the full name corresponding to Sunday, the second string to Monday, and so forth.
- abmon** Defines the abbreviated month names, corresponding to the %b field descriptor. The operand consists of twelve strings separated by semicolons. The first string is an abbreviated name that corresponds to January, the second corresponds to February, and so forth.
- mon** Defines the full month names, corresponding to the %B field descriptor. The operand consists of twelve strings separated by semicolons. The first string is an abbreviated name that corresponds to January, the second corresponds to February, and so forth.

**d\_t\_fmt**

Defines the appropriate date and time representation, corresponding to the %c field descriptor. The operand consists of a string, which may contain any combination of characters and field descriptors.

**d\_fmt**

Defines the appropriate date representation, corresponding to the %x field descriptor. The operand consists of a string, and may contain any combination of characters and field descriptors.

**t\_fmt**

Defines the appropriate time representation, corresponding to the %X field descriptor. The operand consists of a string, which may contain any combination of characters and field descriptors.

**am\_pm**

Defines the appropriate representation of the ante meridian and post meridian strings, corresponding to the %p field descriptor. The operand consists of two strings, separated by a semicolon. The first string represents the ante meridian designation, the last string the post meridian designation.

**t\_fmt\_ampm**

Defines the appropriate time representation in the 12-hour clock format with am\_pm, corresponding to the %r field descriptor. The operand consists of a string and can contain any combination of characters and field descriptors.

**era**

Defines how the years are counted and displayed for each era (or emperor's reign) in a locale. No era is needed if the %E field descriptor modifier is not used for the locale. See the description of the `strftime()` function in *z/OS XL C/C++ Runtime Library Reference* for information about this field descriptor.

For each era, there must be one string in the following format:

`direction:offset:start_date:end_date:name:format`

**direction**

Either a + or - character. The + character indicates the time axis should be such that the years count in the positive direction when moving from the starting date towards the ending date. The - character indicates the time axis should be such that the years count in the negative direction when moving from the starting date towards the ending date.

**offset** A number of the first year of the era.

**start\_date**

A date in the form `yyyy/mm/dd` where `yyyy`, `mm` and `dd` are the year, month and day numbers, respectively, of the start of the era.

Years prior to the year AD 0 are represented as negative numbers. For example, an era beginning March 5th in the year 100 BC would be represented as -100/3/5.

**end\_date**

The ending date of the era in the same form as the start\_date above or one of the two special values -\* or +\*. A value of -\* indicates the ending date of the era extends to the beginning of time while +\* indicates it extends to the end of time. The ending date may be either before or after the starting date of an era. For example, the strings for the Christian eras AD and BC would be:

```
+0:0000/01/01:+:AD:%EC %Ey
+:1:-0001/12/31:-*:BC:%EC %Ey
```

**name** A string representing the name of the era which is substituted for the %EC field descriptor.

**format** A string for formatting the %EY field descriptor. This string is usually a function of the %EC and %Ey field descriptors.

The operand consists of one string for each era. If there is more than one era, strings are separated by semicolons.

**era\_year**

Defines the format of the year in alternate era format, corresponding to the %EY field descriptor.

**era\_d\_fmt**

Defines the format of the date in alternate era notation, corresponding to the %Ex field descriptor.

**era\_t\_fmt**

Defines the locale's appropriate alternative time format, corresponding to the %Ex field descriptor.

**era\_d\_t\_fmt**

Defines the locale's appropriate alternative date and time format, corresponding to the %Ec field descriptor.

**alt\_digits**

Defines alternate symbols for digits, corresponding to the %0 field descriptor modifier. The operand consists of semicolon-separated strings. The first string is the alternate symbol corresponding to zero, the second string the symbol corresponding to one, and so forth. A maximum of 100 alternate strings may be specified. The %0 modifier indicates that the string corresponding to the value specified by the field descriptor is used instead of the value.

For the definitions of the time formatting descriptors, see the description of the strftime() function in *z/OS XL C/C++ Runtime Library Reference*.

## LC\_MESSAGES category

The LC\_MESSAGES category defines the format and values for positive and negative responses. The following keywords are recognized:

**copy** Specifies the name of an existing locale to be used as the source for the definition of this category. If you specify this keyword, no other keyword should be present in this category. If the locale is not found, an error is reported and no locale output is created. The copy keyword cannot specify a locale that also specifies the copy keyword for the same category.

**yesexpr**

The operand consists of an extended regular expression that describes the acceptable affirmative response to a question that expects an affirmative or negative response.

**noexpr**

The operand consists of an extended regular expression that describes the acceptable negative response to a question that expects an affirmative or negative response.

**yestr**

The operand consists of an fixed string (not a regular expression) that can be used by an application for composition of a message that lists an acceptable affirmative response, such as in a prompt.

**nostr**

The operand consists of an fixed string that can be used by an application for composition of a message that lists an acceptable negative response.

Figure 251 shows an example of how to define the LC\_MESSAGES category.

```

%%%%%%%%%%%%%%%%%%%%%%%%%%%%%%%%%%%%%%%%
LC_MESSAGES
%%%%%%%%%%%%%%%%%%%%%%%%%%%%%%%%%%%%%%%%
% yes expression is a string that starts with
% "SI", "Si" "sI" "si" "s" or "S"
yesexpr "<circumflex><left-parenthesis><left-square-bracket><s><S>/
<right-square-bracket><left-square-bracket><i><I><right-square-bracket>/
<vertical-line><left-square-bracket><s><S><right-square-bracket>/
<right-parenthesis>"

% no expression is a string that starts with
% "NO", "No" "nO" "no" "N" or "n"
noexpr "<circumflex><left-parenthesis><left-square-bracket><n><N>/
<right-square-bracket><left-square-bracket><o><O><right-square-bracket>/
<vertical-line><left-square-bracket><n><N><right-square-bracket>/
<right-parenthesis>"

END LC_MESSAGES

```

Figure 251. Example LC\_MESSAGES definition

## LC\_TOD category

The LC\_TOD category defines the rules used to define the beginning, end, and duration of daylight savings time, and the difference between local time and Greenwich Mean time. This is an IBM extension.

**Note:** LC\_TOD and LC\_SYNTAX are not supported for ASCII locales (a locale specification can not contain a definition for these categories). However, for consistency with EBCDIC locales, localedef generates default values for these categories in ASCII locale objects (the values generated for the C locale but with ASCII code points).

The following keywords are recognized:

**copy** Specifies the name of an existing locale to be used as the source for the definition of this category. If this keyword is specified, no other keyword should be present in this category. If the locale is not found, an error is reported and no locale output is created. The copy keyword cannot specify a locale that also specifies the copy keyword for the same category.

**Note:** If you specify this keyword, no other keyword should be present in this category.

**timezone\_difference**

An integer specifying the time zone difference expressed in minutes. If the local time zone is west of the Greenwich Meridian, this value must be positive. If the local time zone is east of the Greenwich Meridian, this value must be negative. An absolute value greater than 1440 (the number of minutes in a day) for this keyword indicates that z/OS Language Environment is to get the time zone difference from the system.

**timezone\_name**

A string specifying the time zone name such as "PST" (Pacific Standard Time) specified within quotation marks. The default for this field is a NULL string.

**daylight\_name**

A string specifying the Daylight Saving Time zone name, such as "PDT" (Pacific Daylight Time), if there is one available. The string must be specified within quotation marks. If DST information is not available, this is set to NULL, which is also the default. This field must be filled in if DST information as provided by the other fields is to be taken into account by the `mktime()` and `localtime()` functions. These functions ignore DST if this field is NULL.

**start\_month**

An integer specifying the month of the year when Daylight Saving Time comes into effect. This value ranges from 1 through 12 inclusive, with 1 corresponding to January and 12 corresponding to December. If DST is not applicable to a locale, `start_month` is set to 0, which is also the default.

**end\_month**

An integer specifying the month of the year when Daylight Saving Time ceases to be in effect. The specifications are similar to those for `start_month`.

**start\_week**

An integer specifying the week of the month when DST comes into effect. Acceptable values range from -4 to +4. A value of 4 means the fourth week of the month, while a value of -4 means fourth week of the month, counting from the end of the month. Sunday is considered to be the start of the week. If DST is not applicable to a locale, `start_week` is set to 0, which is also the default.

**end\_week**

An integer specifying the week of the month when DST ceases to be in effect. The specifications are similar to those for `start_week`.

**Note:** The `start_week` and `end_week` need not be used. The `start_day` and `end_day` fields can specify either the day of the week or the day of the month. If day of month is specified, `start_week` and `end_week` become redundant.

**start\_day**

An integer specifying the day of the week or the day of the month when DST comes into effect. The value depends on the value of `start_week`. If `start_week` is not equal to 0, this is the day of the week when DST comes into effect. It ranges from 0 through 6 inclusive, with 0 corresponding to Sunday and 6 corresponding to Saturday. If `start_week` equals 0, `start_day` is the day of the month (for the current year) when DST comes into effect. It ranges from 1 through to the last day of the month inclusive. The last day of the month is 31 for January, March, May, July, August, October, and

December. It is 30 for April, June, September, and November. For February, it is 28 on non-leap years and 29 on leap years. If DST is not applicable to a locale, `start_day` is set to 0, which is also the default.

**end\_day**

An integer specifying the day of the week or the day of the month when DST ceases to be in effect. The specifications are similar to those for `start_day`.

**start\_time**

An integer specifying the number of seconds after 12:00 midnight, local standard time, when DST comes into effect. For example, if DST is to start at 2:00 am, `start_time` is assigned the value 7200; for 12:00 am (midnight), `start_time` is 0; for 1:00 am, it is 3600.

**end\_time**

An integer specifying the number of seconds after 12 midnight, local standard time, when DST ceases to be in effect. The specifications are similar to those for `start_time`.

**shift** An integer specifying the DST time shift, expressed in seconds. The default is 3600, for 1 hour.

**uctname**

A string specifying the name to be used for Coordinated Universal Time. If this keyword is not specified, the `uctname` will default to "UTC".

Figure 252 is an example of how to define the `LC_TOD` category.

```
escape_char /
comment-char %

#####
LC_TOD
#####
% the time zone difference is 8hrs; the name of the daylight saving
% time is PDT, and it starts on the first Sunday of April at 2&00AM
% and ends on the second Sunday of October at 2&00AM
timezone_difference +480
timezone_name "<P><S><T>"
daylight_name "<P><D><T>"
start_month 4
end_month 10
start_week 1
end_week 2
start_day 1
end_day 30
start_time 7200
end_time 3600
shift 3600
END LC_TOD
```

Figure 252. Example `LC_TOD` definition

## LC\_SYNTAX category

The `LC_SYNTAX` category defines the variant characters from the portable character set. `LC_SYNTAX` is an IBM-specific extension. This category can be queried by the C library function `getsyntax()` to determine the encoding of a variant character if needed.

**Attention:** Customizing the `LC_SYNTAX` category is not recommended. You should use the `LC_SYNTAX` values obtained from the `charmap` file when you use the `localedef` utility.

The operands for the characters in the LC\_SYNTAX category accept the single byte character specification in the form of a symbolic name, the character itself, or the decimal, octal, or hexadecimal constant. The characters must be specified in the LC\_CTYPE category as a *punct* character. The values for the LC\_SYNTAX characters must be unique. If symbolic names are used to define the encoding, only the symbolic names listed for each character should be used.

The code points for the LC\_SYNTAX characters are set to the code points specified. Otherwise, they default to the code points for the respective characters from the charmap file, if the file is present, or to the code points of the respective characters in the IBM-1047 code page.

**Note:** LC\_TOD and LC\_SYNTAX are not supported for ASCII locales (a locale specification can not contain a definition for these categories). However, for consistency with EBCDIC locales, localedef generates default values for these categories in ASCII locale objects (the values generated for the C locale but with ASCII code points).

The following keywords are recognized:

**copy** Specifies the name of an existing locale to be used as the source for the definition of this category. If you specify this keyword, no other keyword should be present. If the locale is not found, an error is reported and no locale output is created. The copy keyword cannot specify a locale that also specifies the copy keyword for the same category.

**backslash**

Specifies a string that defines the value used to represent the backslash character. If this keyword is not specified, the value from the charmap file for the character <backslash>, <reverse-solidus>, or <SM07> is used, if it is present.

**right\_brace**

Specifies a string that defines the value used to represent the right brace character. If this keyword is not specified, the value from the charmap file for the character <right-brace>, <right-curly-bracket>, or <SM14> is used, if it is present.

**left\_brace**

Specifies a string that defines the value used to represent the left brace character. If this keyword is not specified, the value from the charmap file for the character <left-brace>, <left-curly-bracket>, or <SM11> is used, if it is present.

**right\_bracket**

Specifies a string that defines the value used to represent the right bracket character. If this keyword is not specified, the value from the charmap file for the character <right-square-bracket>, or <SM08> is used, if it is present.

**left\_bracket**

Specifies a string that defines the value used to represent the left bracket character. If this keyword is not specified, the value from the charmap file for the character <left-square-bracket>, or <SM06> is used, if it is present.

**circumflex**

Specifies a string that defines the value used to represent the circumflex character. If this keyword is not specified, the value from the charmap file for the character <circumflex>, <circumflex-accent>, or <SD15> is used, if it is present.

**tilde** Specifies a string that defines the value used to represent the tilde character. If this keyword is not specified, the value from the charmap file for the character <tilde>, or <SD19> is used, if it is present.

**exclamation\_mark**

Specifies a string that defines the value used to represent the exclamation mark character. If this keyword is not specified, the value from the charmap file for the character <exclamation-mark>, or <SP02> is used, if it is present.

**number\_sign**

Specifies a string that defines the value used to represent the number sign character. If this keyword is not specified, the value from the charmap file for the character <number-sign>, or <SM01> is used, if it is present.

**vertical\_line**

Specifies a string that defines the value used to represent the vertical line character. If this keyword is not specified, the value from the charmap file for the character <vertical-line>, or <SM13> is used, if it is present.

**dollar\_sign**

Specifies a string that defines the value used to represent the dollar sign character. If this keyword is not specified, the value from the charmap file for the character <dollar-sign>, or <SC03> is used, if it is present.

**commercial\_at**

Specifies a string that defines the value used to represent the commercial at character. If this keyword is not specified, the value from the charmap file for the character <commercial-at>, or <SM05> is used, if it is present.

**grave\_accent**

Specifies a string that defines the value used to represent the grave accent character. If this keyword is not specified, the value from the charmap file for the character <grave-accent>, or <SD13> is used, if it is present.

Figure 253 is an example of how the LC\_SYNTAX category is defined.

```
escape_char /
comment-char %

%%%%%%%%%%
LC_SYNTAX
%%%%%%%%%%

backslash      "<backslash>"
right_brace    "<right-brace>"
left_brace     "<left-brace>"
right_bracket  "<right-square-bracket>"
left_bracket   "<left-square-bracket>"
circumflex     "<circumflex>"
tilde          "<tilde>"
exclamation_mark "<exclamation-mark>"
number_sign    "<number-sign>"
vertical_line  "<vertical-line>"
dollar_sign    "<dollar-sign>"
commercial_at  "<commercial-at>"
grave_accent   "<grave-accent>"

END LC_SYNTAX
```

Figure 253. Example definition of LC\_SYNTAX



---

## Method files

Method files can be used when creating ASCII locales. They specify the method functions used by the C runtime's locale-sensitive interfaces when the ASCII locale is activated.

IBM ships the method files used to build its ASCII locales in the `/usr/lib/nls/method` directory. These method files support various ASCII Latin 1 and non-Latin 1 single byte encodings, ASCII SJIS and EUC multibyte encodings and UTF-8 multibyte encodings.

By replacing the CHARMAP related method functions in a method file, users can create a locale which supports a user-defined code page. For each replaced method, the method file supplies the user-written method function name, and optionally indicates where the method function code is to be found (.o file, archive library or DLL). The method source file maps method names to the National Language Support (NLS) subroutines that implement those methods. The method file also specifies the object libraries or DLL side decks where the implementing subroutines are stored. The methods correspond to those subroutines that require direct access to the data structures representing locale data.

Each user provided method must follow the standard interface defined for the API it implements and add an argument of type `_LC_charmap_objhdl_t` as the first argument. The `_LC_charmap_objhdl_t` is defined in the `localedef.h` header file.

Users can provide these CHARMAP methods via a DLL side deck, an archive library or an object file. The user-written method functions are used both by the locale-sensitive APIs they represent, and also by the `localedef` utility itself while generating the method-file based ASCII locale object. This second use by `localedef` itself causes a temporary DLL to be created while processing the CHARMAP file supplied on the `-f` parameter. The name of the file containing method objects or side deck information is passed by the `localedef` utility as a parameter on the `c89` command line, so the standard archive/object/side deck suffix naming conventions apply (for example, `.a`, `.o`, `.x`).

Figure 254 on page 990 shows the expected grammar for a method file.



```

method_def :
  "METHODS"
  method_assign_list "END METHODS"
  ;
  method_assign_list :
method_assign_list method_assign
  method_assign_list
  method_assign
  ;

  method_assign :
"csid" meth_name meth_lib_path
  "fnmatch" meth_name meth_lib_path
  "is_wctype" meth_name meth_lib_path
  "mblen" meth_name meth_lib_path
  "mbstowcs" meth_name meth_lib_path
  "mbtowc" meth_name meth_lib_path
  "regcomp" meth_name meth_lib_path
  "regerror" meth_name meth_lib_path
  "regex" meth_name meth_lib_path
  "regfree" meth_name meth_lib_path
  "rpmatch" meth_name meth_lib_path
  "strcoll" meth_name meth_lib_path
  "strfmon" meth_name meth_lib_path
  "strftime" meth_name meth_lib_path
  "strptime" meth_name meth_lib_path
  "strxfrm" meth_name meth_lib_path
  "tolower" meth_name meth_lib_path
  "toupper" meth_name meth_lib_path
  "wcsoll" meth_name meth_lib_path
  "wcsftime" meth_name meth_lib_path
  "wcsid" meth_name meth_lib_path
  "wcstombs" meth_name meth_lib_path
  "wcswidth" meth_name meth_lib_path
  "wcsxfrm" meth_name meth_lib_path
  "wctomb" meth_name meth_lib_path
  "wcwidth" meth_name meth_lib_path
  ;

  meth_name:
global_name
cfunc_name
;

```

*Expected grammar for method files (Part 1 of 2)*

*Figure 254. Expected grammar for method files*

```

global_name:
CSID_STD
FNMATCH_C
FNMATCH_STD
GET_WCTYPE_STD
IS_WCTYPE_SB
IS_WCTYPE_STD
LOCALECONV_STD
MBLEN_932
MBLEN_EUCJP
MBLEN_SB
MBSTOWCS_932
MBSTOWCS_EUCJP
MBSTOWCS_SB
MBTOWC_932
MBTOWC_EUCJP
MBTOWC_SB
REGCOMP_STD
REGERROR_STD
REGEXEC_STD
REGFREE_STD
RPMATCH_C
RPMATCH_STD
STRCOLL_C
STRCOLL_SB
STRCOLL_STD
STRFMON_STD
STRFTIME_STD
STRPTIME_STD
STRXFRM_C
STRXFRM_SB
STRXFRM_STD
TOWLOWER_STD
TOWUPPER_STD
WCSCOLL_C
WCSCOLL_STD
WCSFTIME_STD
WCSID_STD
WCSTOMBS_932
WCSTOMBS_EUCJP
WCSTOMBS_SB
WCSWIDTH_932
WCSWIDTH_EUCJP
WCSWIDTH_LATIN
WCSXFRM_C
WCSXFRM_STD
WCTOMB_932
WCTOMB_EUCJP
WCTOMB_SB
WCWIDTH_932
WCWIDTH_EUCJP
WCWIDTH_LATIN
;

```

*Expected grammar for method files (Part 2 of 2)*

Where `cfunc_name` is the name of a user supplied subroutine, and `meth_lib_path` is an optional path name for the file containing the compiled subroutine or a side-deck for the DLL containing the subroutine.

The `localedef` command parses this information to determine the methods to be used for this locale. The following subroutines must be specified in the method file:

```
mblen      mbstowcs
mbtowc     wcstombs
wcswidth   wctomb
wcwidth
```

The following additional subroutines are mandatory in AIX method files, but are not supported on z/OS and if specified are ignored:

```
mbtopc
mbstopcs
pctomb
pcstombs
```

Any other method not specified in the method file retains the default. Mixing of user-written method function names (represented as `cfunc_name` in the grammar) and IBM-provided method function names (represented by `global_name` in the grammar) is not allowed. A method file should not include both. If the `localedef` command encounters both `cfunc_name` values and `global_name` values in a method file, an error is generated and the locale is not created.

It is not mandatory that the `METHODS` section specify the `meth_lib_path` name for all methods. The following is an example of how to specify the `meth_lib_path` and what the `localedef` passes on the `c89` command invoking the binder when linking the method-based ASCII locale object:

```
METHODS

mblen "__mblen_myuni"
mbstowcs "__mbstowcs_myuni" "/u/my/libmyuni.a"
mbtowc "__mbtowc_myuni"
wcstombs "__wcstombs_myuni" "/u/gen/libgenuni.a"
wcswidth "__wcswidth_myuni"
wctomb "__wctomb_myuni"
wcwidth "__wcwidth_myuni" "./wcwidth.o"
```

In the example, `libmyuni.a` contains functions `__mbstowcs_myuni` and `__mbtowc_myuni`. Similarly, `libgenuni.a` contains functions `__wcstombs_myuni`, `__wcswidth_myuni` and `__wctomb_myuni`. The function `__wcwidth_myuni` is contained in the file `wcwidth.o`. If the function `__mblen_myuni` is not defined in either of the three files indicated, a locale object will not be created. For this example the `localedef` utility would invoke the binder using the following `c89` command line:

```
c89 -o myuni.locale -Wl,xplink ./localefBGgfFcGAo
./localeEgaBGaahA.o /u/my/libmyuni.a
/u/gen/libgenuni.a ./wcwidth.o
```

It is also possible to use the `-L` `localedef` option to specify the `c89` `-L` library flags and only reference the library names in the method file following the `liblibname.a` convention.

If an individual method does not specify a `meth_lib_path` name, the method inherits the most recently specified `meth_lib_path` name. If no `meth_lib_path` name is specified in the `METHODS` section, the default runtime library side-deck is assumed. The files indicated by `meth_lib_path` names of all methods in the method

file are used when linking the locale object. A concatenated list of all `meth_lib_path` names is specified on the link step. If multiple object libraries or side decks are specified, the same routine should not be defined in more than one of them. Unexpected results may occur if the method functions appear in more than one file, particularly if the duplicate copies are not identical. The binder could resolve a method function from a file different from the one given in the method file itself.

The method for the `mbtowc` and `wcwidth` subroutines should avoid calling other methods where possible.

---

## Using the `localedef` utility

The locale objects or locales are generated using the `localedef` utility. The `localedef` utility:

1. Reads the *locale definition file*
2. Resolves all the character symbolic names to the values of characters defined in the specified *character set definition file*, (`CHARMAP`)
3. Produces a z/OS XL C source file.
4. Compiles the source file using the z/OS XL C compiler and link-edits the produced text module to produce a locale object. `localedef` produces ASCII locale objects as XPLINK DLL's exclusively, while EBCDIC locales can be non-XPLINK objects or XPLINK DLL's.

**Note:** AMODE 64 locales are always XPLINK locales, while 31-bit locales may be XPLINK or non-XPLINK.

The locale DLL object can be loaded by the `setlocale()` function and then accessed by the z/OS XL C/C++ functions that are sensitive to the cultural information, or that can query the locales. For a list of all the library functions sensitive to locale, see "Locale-sensitive interfaces" on page 952. For detailed information on how to invoke `localedef`, see "localedef Utility" in the *z/OS XL C/C++ User's Guide*.

The locale DLL object created by `localedef` must adhere to certain naming conventions so that the locale can be used by the system. These conventions are outlined in "Locale naming conventions" on page 994.

XPLINK applications require XPLINK locale objects, and non-XPLINK applications require non-XPLINK locale objects. Likewise, AMODE 64 applications require AMODE 64 locale objects. `localedef` creates non-XPLINK locales by default. The option `XPLINK` causes the TSO `localedef` command (`LOCALDEF`) to produce an XPLINK locale object. The batch XPLINK `localedef` command (`EDCXLDEF proc`) produces an XPLINK locale object (while the batch `localedef` command (`EDCLDEF`) produces a non-XPLINK locale object). The `-X` parameter causes the UNIX System Services `localedef` command to generate an XPLINK locale object.

The TSO `localedef` (`LOCALDEF`) command and the batch XPLINK `localedef` command (`EDCXLDEF proc`) cannot be used to generate ASCII locales or AMODE 64 locales. Only the UNIX System Services `localedef` command may be used. ASCII locales are generated by specifying the `-A localedef` option on the command line of the UNIX System Services `localedef` command. AMODE 64 locales are generated by specifying the `-6` option on the command line of the UNIX System Services `localedef` command. Specify both `-A` and `-6` to produce locale objects which are both ASCII and AMODE 64. AMODE 64 locales are always XPLINK locales. The `-X` option is implicitly specified whenever the `-6` option is

specified. Users can supply functions for the methods referenced in the locale charmap category by indicating the `-m method_file` option on the command line.

The POSIX shell (`/bin/sh`) UNIX System Services shell, `/bin/sh`, is an example of a non-XPLINK application that uses locales. It needs non-XPLINK locales. If the shell invokes an XPLINK application that uses locales, the application will need an XPLINK version of the same locale. Usually, both XPLINK and non-XPLINK versions of a locale are needed whenever an XPLINK application is invoked from the shell, or when an XPLINK application invokes the shell or any other non-XPLINK application. Likewise, usually both AMODE 64 and non-XPLINK versions of a locale are needed whenever a AMODE 64 application is invoked from the shell, or when a AMODE 64 application invokes the shell or any other non-XPLINK application. The locale object naming conventions ensure that the runtime library loads the appropriate version of the locale.

## Locale naming conventions

The `setlocale()` library function that selects the active locale maps the descriptive locale name into the name of the locale object before loading the locale and making it accessible.

In z/OS XL C/C++ programs, the locale modules are referred to by descriptive locale names. The locale names themselves are not case sensitive. They follow these conventions:

`<Language>-<Territory>.<Codeset>`

### Language

is a two-letter uppercase abbreviation for the language name. The abbreviations come from the ISO 639 standard.

### Territory

is a two-letter uppercase abbreviation for the territory name. The abbreviation comes from the ISO 3166 standard.

### Codeset

is the name registered by the MIT X Consortium that identifies the registration authority that owns the specific encoding. A modifier may be added to the registered name but is not required. The modifier is of the form `@codeset modifier` and identifies the coded character set as defined by that registration authority.

The Codeset parts are optional. If they are not specified, Codeset defaults to IBM-`nnn`, where `nnn` is the default code page, which for EBCDIC locales is shown in Table 351 on page 996 and for ASCII locales in Table 352 on page 998. (The modifier portion defaults to nothing.)

For PDS resident locales, the mapping between the descriptive locale name and the eight-character name of the locale object is performed as follows:

1. The Language-Territory part is mapped into a two-letter LT code.
2. The Codeset part is mapped into a two-letter CC code.
3. The object name is built from a prefix, the two-letter LT code, and the two-letter CC code. The prefix is one of the following show in Table 350 on page 995. (Note that the @-sign in the PDS and z/OS UNIX locale names always has Latin-1/Open Systems encoding; see IBM-1047 CHARMAP.)

Table 350. Locale object prefix

Application	No modifier	@euro modifier	@preeuro modifier
non-XPLINK	EDC\$	EDC@	EDC3
XPLINK	CEH\$	CEH@	CEH3
XPLINK ASCII	CEJ\$	NA	NA
AMODE 64	CEQ\$	CEQ@	CEQ3
AMODE 64 ASCII	CEZ\$	NA	NA

Type	Mapping
Non-XPLINK	Fr_BE.IBM-1148 maps to EDC\$FBHO Fr_BE.IBM-1148@euro maps to EDC@FBHO Fr_BE.IBM-1148@preeuro maps to EDC3FBHO
XPLINK	Fr_BE.IBM-1148 maps to CEH\$FBHO Fr_BE.IBM-1148@euro maps to CEH@FBHO Fr_BE.IBM-1148@preeuro maps to CEH3FBHO
ASCII	Fr_BE.IS08859-1 maps to CEJ\$FBI1 Fr_BE.UTF-8 maps to CEJ\$FBU8
AMODE 64	Fr_BE.IBM-1148 maps to CEQ\$FBHO Fr_BE.IBM-1148@euro maps to CEQ@FBHO Fr_BE.IBM-1148@preeuro maps to CEQ3FBHO
AMODE 64 ASCII	Fr_BE.IS08859-1 maps to CEZ\$FBI1 Fr_BE.UTF-8 maps to CEZ\$FBU8

For resident locales in the z/OS UNIX file system, the mapping between the descriptive locale name and the z/OS UNIX file name is performed as follows:

1. The locale object file name starts out the same as the descriptive name.
2. If the locale object is XPLINK, add a suffix of ".xplink" to the end of the object file name.
3. If the locale object is AMODE 64, add a suffix of ".lp64" to the end of the object file name.

Type	Mapping
Non-XPLINK	Fr_BE.IBM-1148 maps to Fr_BE.IBM-1148 Fr_BE.IBM-1148@euro maps to Fr_BE.IBM-1148@euro Fr_BE.IBM-1148@preeuro maps to Fr_BE.IBM-1148@preeuro
XPLINK	Fr_BE.IBM-1148 maps to Fr_BE.IBM-1148.xplink Fr_BE.IBM-1148@euro maps to Fr_BE.IBM-1148@euro.xplink Fr_BE.IBM-1148@preeuro maps to Fr_BE.IBM-1148@preeuro.xplink
ASCII	Fr_BE.IS08859-1 maps to Fr_BE.IS08859-1.xplink Fr_BE.UTF-8 maps to Fr_BE.UTF-8.xplink
AMODE 64	Fr_BE.IBM-1148 maps to FR_BE.IBM-1148.lp64 Fr_BE.IBM-1148@euro maps to Fr_BE.IBM-1148@euro.lp64 Fr_BE.IBM-1148@preeuro maps to Fr_BE.IBM-1148@preeuro.lp64
AMODE 64 ASCII	Fr_BE.IS08859-1 maps to Fr_BE.IS08859-1.lp64 Fr_BE.UTF-8 maps to Fr_BE.UTF-8.lp64

The mapping between Language-Territory and the two-letter LT code is defined in the LT conversion table EDC\$LCNM, built with assembler macros as follows:

```

EDC$LCNM TITLE 'LOCALE NAME CONVERSION TABLE'
EDC$LCNM CSECT
EDCLOCNM TYPE=ENTRY,LOCALE='DA_DK',CODESET='IBM-1047',CODE='DA'
EDCLOCNM TYPE=ENTRY,LOCALE='DE_BE',CODESET='IBM-1047',CODE='DB'
EDCLOCNM TYPE=ENTRY,LOCALE='DE_CH',CODESET='IBM-1047',CODE='DC'
EDCLOCNM TYPE=ENTRY,LOCALE='DE_DE',CODESET='IBM-1047',CODE='DD'
EDCLOCNM TYPE=ENTRY,LOCALE='JA_JP',CODESET='IBM-939',CODE='EJ'
:
EDCLOCNM TYPE=END
END EDC$LCNM

```

LOCALE specifies the name of Language-Territory, while CODE specifies the respective LT code.

You can customize this table by adding new LOCALE name mappings. z/OS XL C/C++ reserves alphabetic LT codes, but you can use codes containing numeric values for your own customized names.

The Language-Territory names and their mappings into LT codes that are provided are shown in Table 351.

*Table 351. Supported language-territory names and LT codes for EBCDIC locales*

Locale Name	Language	Country/Territory	EBCDIC Codeset	2-Byte LT Code
Ar_AA	Arabic	Algeria, Bahrain, Egypt, Iraq, Jordan, Kuwait, Lebanon, Libya, Morocco, Oman, Qatar, Saudi Arabia, Syria, Tunisia, U.A.E., Yemen	IBM-425	AR
Be_BY	Byelorussian	Belarus	IBM-1025	BB
Bg_BG	Bulgarian	Bulgaria	IBM-1025	BG
C			IBM-1047	CC
Ca_ES	Catalan	Spain	IBM-924	CS
Cs_CZ	Czech	Czech Republic	IBM-870	CZ
Da_DK	Danish	Denmark	IBM-1047	DA
De_AT	German	Austria	IBM-924	DT
De_CH	German	Switzerland	IBM-1047	DC
De_DE	German	Germany	IBM-1047	DD
De_LU	German	Luxembourg	IBM-924	DL
El_GR	Greek	Greece	IBM-875	EL
En_AU	English	Australia	IBM-1047	NA
En_BE	English	Belgium	IBM-924	EB
En_CA	English	Canada	IBM-1047	EC
En_GB	English	United Kingdom	IBM-1047	EK
En_HK	English	China (Hong Kong S.A.R. of China)	IBM-1047	NH
En_IE	English	Ireland	IBM-924	EI
En_IN	English	India	IBM-1047	NI
En_JP	English	Japan	IBM-1027	EJ
En_NZ	English	New Zealand	IBM-1047	NZ

Table 351. Supported language-territory names and LT codes for EBCDIC locales (continued)

Locale Name	Language	Country/Territory	EBCDIC Codeset	2-Byte LT Code
En_PH	English	Philippines	IBM-1047	NP
En_SG	English	Singapore	IBM-1047	NS
En_US	English	United States	IBM-1047	EU
En_ZA	English	South Africa	IBM-1047	EZ
Es_AR	Spanish	Argentina	IBM-1047	EA
Es_BO	Spanish	Bolivia	IBM-1047	EO
Es_CL	Spanish	Chile	IBM-1047	EH
Es_CO	Spanish	Colombia	IBM-1047	FG
Es_CR	Spanish	Costa Rica	IBM-1047	ER
Es_DO	Spanish	Dominican Republic	IBM-1047	ED
Es_EC	Spanish	Ecuador	IBM-1047	EQ
Es_ES	Spanish	Spain	IBM-1047	ES
Es_GT	Spanish	Guatemala	IBM-1047	EG
Es_HN	Spanish	Honduras	IBM-1047	FE
Es_MX	Spanish	Mexico	IBM-1047	EM
Es_NI	Spanish	Nicaragua	IBM-1047	FA
Es_PA	Spanish	Panama	IBM-1047	EP
Es_PE	Spanish	Peru	IBM-1047	EW
Es_PR	Spanish	Puerto Rico	IBM-1047	EX
Es_PY	Spanish	Paraguay	IBM-1047	EY
Es_SV	Spanish	El Salvador	IBM-1047	EV
Es_US	Spanish	United States	IBM-1047	ET
Es_UY	Spanish	Uruguay	IBM-1047	FD
Es_VE	Spanish	Venezuela	IBM-1047	EF
Et_EE	Estonian	Estonia	IBM-1122	EE
Fi_FI	Finnish	Finland	IBM-1047	FI
Fr_BE	French	Belgium	IBM-1047	FB
Fr_CA	French	Canada	IBM-1047	FC
Fr_CH	French	Switzerland	IBM-1047	FS
Fr_FR	French	France	IBM-1047	FF
Fr_LU	French	Luxembourg	IBM-924	FL
He_IL	Hebrew	Israel	IBM-424	IL
Hr_HR	Croatian	Croatia	IBM-870	HR
Hu_HU	Hungarian	Hungary	IBM-870	HU
Id_ID	Indonesian	Indonesia	IBM-1047	II
It_CH	Italian	Switzerland	IBM-1047	IC
Is_IS	Icelandic	Iceland	IBM-871	IS
It_IT	Italian	Italy	IBM-1047	IT



Table 351. Supported language-territory names and LT codes for EBCDIC locales (continued)

Locale Name	Language	Country/Territory	EBCDIC Codeset	2-Byte LT Code
Ja_JP	Japanese	Japan	IBM-939	JA
Ko_KR	Korean	Korea	IBM-933	KR
Iw_IL	Hebrew	Israel	IBM-424	IL
Lt-LT	Lithuanian	Lithuania	IBM-1112	LT
Lv_LV	Latvian	Latvia	IBM-1112	LL
Mk_MK	Macedonian	Macedonia	IBM-1025	MM
Ms_MY	Malay	Malaysia	IBM-1047	MY
NL_BE	Dutch	Belgium	IBM-1047	NB
NL_NL	Dutch	The Netherlands	IBM-1047	NN
No_NO	Norwegian	Norway	IBM-1047	NO
Pl_PL	Polish	Poland	IBM-870	PL
Pt_BR	Portuguese	Brazil	IBM-1047	BR
Pt_PT	Portuguese	Portugal	IBM-1047	PT
Ro_RO	Romanian	Romania	IBM-870	RO
Ru_RU	Russian	Russia	IBM-1025	RU
Sh_SP	Serbian (Latin)	Serbia	IBM-870	SL
Sk_SK	Slovak	Slovakia	IBM-870	SK
Sl_SI	Slovene	Slovenia	IBM-870	SI
Sq_AL	Albanian	Albania	IBM-500	SA
Sr_SP	Serbian (Cyrillic)	Serbia	IBM-1025	SC
Sv_SE	Swedish	Sweden	IBM-1047	SV
Th_TH	Thai	Thailand	IBM-838	TH
Tr_TR	Turkish	Turkey	IBM-1026	TR
UK_UA	Ukrainian	Ukraine	IBM-1125	UU
Zh_CN	Simplified Chinese	China (PRC)	IBM-935	ZC
Zh_TW	Traditional Chinese	Taiwan	IBM-937	ZT

Table 352 shows the supported language-territory names and LT codes for ASCII locales. Note that ASCII locale names can also be coded <uppercase><lowercase>\_<uppercase><uppercase>. For example, both en\_US and En\_US are valid ASCII locale names.

Table 352. Supported language-territory names and LT codes for ASCII locales

Locale Name	Language	Country/Territory	ASCII Codeset	2-Byte LT Code
be_BY	Byelorussian	Belarus	ISO8859-5	BB
bn_IN	Bengali	India	UTF-8	BN
en_CA	English	Canada	ISO8859-1	EC

Table 352. Supported language-territory names and LT codes for ASCII locales (continued)

Locale Name	Language	Country/Territory	ASCII Codeset	2-Byte LT Code
cs_CZ	Czech	Czech Republic	ISO8859-2	CZ
en_ZA	English	South Africa	ISO8859-1	EZ
da_DK	Danish	Denmark	ISO8859-1	DA
de_CH	German	Switzerland	ISO8859-1	DC
de_DE	German	Germany	ISO8859-1	DD
el_GR	Greek	Greece	ISO8859-7	EL
en_AU	English	Australia	ISO8859-1	NA
en_GB	English	United Kingdom	ISO8859-1	EK
en_HK	English	China (Hong Kong S.A.R. of China)	ISO8859-1	NH
en_IN	English	India	ISO8859-1	NI
en_NZ	English	New Zealand	ISO8859-1	NZ
en_PH	English	Philippines	ISO8859-1	NP
en_SG	English	Singapore	ISO8859-1	NS
en_US	English	United States	ISO8859-1	EU
es_AR	Spanish	Argentina	ISO8859-1	EA
es_BO	Spanish	Bolivia	ISO8859-1	EO
es_CL	Spanish	Chile	ISO8859-1	EH
es_CO	Spanish	Colombia	ISO8859-1	FG
es_CR	Spanish	Costa Rica	ISO8859-1	ER
es_DO	Spanish	Dominican Republic	ISO8859-1	ED
es_EC	Spanish	Ecuador	ISO8859-1	EQ
es_ES	Spanish	Spain	ISO8859-1	ES
es_GT	Spanish	Guatemala	ISO8859-1	EG
es_HN	Spanish	Honduras	ISO8859-1	FE
es_MX	Spanish	Mexico	ISO8859-1	EM
es_NI	Spanish	Nicaragua	ISO8859-1	FA
es_PA	Spanish	Panama	ISO8859-1	EP
es_PE	Spanish	Peru	ISO8859-1	EW
es_PR	Spanish	Puerto Rico	ISO8859-1	EX
es_PY	Spanish	Paraguay	ISO8859-1	EY
es_SV	Spanish	El Salvador	ISO8859-1	EV
es_US	Spanish	United States	ISO8859-1	ET
es_UY	Spanish	Uruguay	ISO8859-1	FD
es_VE	Spanish	Venezuela	ISO8859-1	EF
fi_FI	Finnish	Finland	ISO8859-1	FI
fr_BE	French	Belgium	ISO8859-1	FB
fr_CA	French	Canada	ISO8859-1	FC
fr_CH	French	Switzerland	ISO8859-1	FS

Table 352. Supported language-territory names and LT codes for ASCII locales (continued)

Locale Name	Language	Country/Territory	ASCII Codeset	2-Byte LT Code
fr_FR	French	France	ISO8859-1	FF
gu_IN	Gujarati	India	UTF-8	GI
he_IL	Hebrew	Israel	ISO8859-8	IL
hi_IN	Hindi	India	UTF-8	IN
hr_HR	Croatian	Croatia	ISO8859-2	HR
hu_HU	Hungarian	Hungary	ISO8859-2	HU
id_ID	Indonesian	Indonesia	ISO8859-1	II
it_CH	Italian	Switzerland	ISO8859-1	IC
it_IT	Italian	Italy	ISO8859-1	IT
iw_IL	Hebrew	Israel	ISO8859-8	IL
ja_JP	Japanese	Japan	IBM-943	JA
kk_KZ	Kazakh	Kazakstan	UTF-8	KK
ko_KR	Korean	Korea	IBM-eucKR	KR
mr_IN	Marati	India	UTF-8	MI
ms_MY	Malay	Malaysia	ISO8859-1	MY
nl_NL	Dutch	Netherlands	ISO8859-1	NN
no_NO	Norwegian	Norway	ISO8859-1	NO
pa_IN	Punjabi	India	UTF-8	PI
pl_PL	Polish	Poland	ISO8859-2	PL
pt_BR	Portuguese	Brazil	ISO8859-1	BR
pt_PT	Portuguese	Portugal	ISO8859-1	PT
ro_RO	Romanian	Romania	ISO8859-2	RO
ru_RU	Russian	Russia	ISO8859-5	RU
sk_SK	Slovak	Slovakia	ISO8859-2	SK
sl_SI	Slovene	Slovenia	ISO8859-2	SI
sv_SE	Swedish	Sweden	ISO8859-1	SV
ta_IN	Tamil	India	UTF-8	AN
te_IN	Telugu	India	UTF-8	EN
th_TH	Thai	Thailand	TIS-620	TH
tr_TR	Turkish	Turkey	ISO8859-9	TR
zh_CN	Simplified Chinese	China (PRC)	IBM-eucCN	ZC
zh_HKS	Simplified Chinese	China (Hong Kong S.A.R. of China)	UTF-8	ZG
zh_HKT	Traditional Chinese	China (Hong Kong S.A.R. of China)	UTF-8	ZU
zh_SGS	Simplified Chinese	Singapore	UTF-8	ZS
zh_TW	Simplified Chinese	Taiwan	BIG5	ZT

The mapping between Codeset and the two-letter CC code is defined in the CC conversion table EDCUCSNM. This table is built with assembler macros, as follows:

```
EDCUCSNM TITLE 'CODE SET NAME CONVERSION TABLE'
EDCUCSNM CSECT
EDCCSNAM TYPE=ENTRY, CODESET=' IBM-037 ', CODE='EA'
EDCCSNAM TYPE=ENTRY, CODESET=' IBM-273 ', CODE='EB'
EDCCSNAM TYPE=ENTRY, CODESET=' IBM-274 ', CODE='EC'
EDCCSNAM TYPE=ENTRY, CODESET=' IBM-277 ', CODE='ED'
EDCCSNAM TYPE=ENTRY, CODESET=' IBM-278 ', CODE='EE'
:
EDCCSNAM TYPE=END
END EDCUCSNM
```

CODESET specifies the name Codeset; CODE specifies the respective CC code.

You can customize this table by adding new CODESET names. The alphabetic codes in the first byte of each CC name are reserved by IBM for future use, but you can use codes starting with numeric values for your own customized names.

Table 353 lists the Codeset names and their mappings into CC codes that are provided.

*Table 353. Supported codeset names and CC codes*

Codesets	Primary Country or Territory	2-Byte CC code
Big5	Taiwan	BT
IBM-037	USA, Canada, Brazil	EA
IBM-273	Germany, Austria	EB
IBM-274	Belgium	EC
IBM-277	Denmark, Norway	EE
IBM-278	Finland, Sweden	EF
IBM-280	Italy	EG
IBM-282	Portugal	EI
IBM-284	Spain, Latin America	EJ
IBM-285	United Kingdom	EK
IBM-290	Japan (Katakana)	EL
IBM-297	France	EM
IBM-300	Japanese DBCS	EN
IBM-420	Algeria, Bahrain, Egypt, Iraq, Jordan, Kuwait, Lebanon, Libya, Morocco, Oman, Qatar, Saudi Arabia, Syria, Tunisia, U.A.E., Yemen	FF
IBM-424	Israel	FB
IBM-425	Algeria, Bahrain, Egypt, Iraq, Jordan, Kuwait, Lebanon, Libya, Morocco, Oman, Qatar, Saudi Arabia, Syria, Tunisia, U.A.E., Yemen	AR
IBM-500	International	EO
IBM-838	Thailand	EP
IBM-848	Ukraine with Euro (Cyrillic)	AS

Table 353. Supported codeset names and CC codes (continued)

Codesets	Primary Country or Territory	2-Byte CC code
IBM-870	Croatia, Czech Republic, Hungary, Poland, Romania, Serbia(Latin), Slovakia, Slovenia	EQ
IBM-871	Iceland	ER
IBM-875	Greece	ES
IBM-880	Cyrillic	ET
IBM-924	Latin 9/Open Systems	DL
IBM-930	Japan Katakana Extended (combined with DBCS)	EU
IBM-933	Korea	GZ
IBM-935	China(PRC)	GY
IBM-937	Taiwan	GW
IBM-943	Japan	JA
IBM-943	China (PRC)	No
IBM-943G	Japan	AN
IBM-1025	Bulgaria, Macedonia, Russia, Serbia (Cyrillic)	FE
IBM-1026	Turkey	EW
IBM-1027	Japan (Latin) Extended	EX
IBM-1047	Latin 1/Open Systems	EY
IBM-1112	Lithuania	GD
IBM-1122	Estonia	FD
IBM-1123	Ukraine (Cyrillic)	FH
IBM-1125	Ukraine (Cyrillic)	AT
IBM-1140	USA, Canada, Brazil	HA
IBM-1141	Austria, Germany	HB
IBM-1142	Denmark, Norway	HE
IBM-1143	Finland, Sweden	HF
IBM-1144	Italy	HG
IBM-1145	Spain, Latin America	HJ
IBM-1146	United Kingdom	HK
IBM-1147	France	HM
IBM-1148	International	HO
IBM-1149	Iceland	HR
IBM-1153	Czech Republic, Hungary, Poland, Slovakia, Slovenia	MB
IBM-1156	Latvia, Lithuania	HZ
IBM-1157	Estonia	HD
IBM-1158	Ukraine with Euro (Cyrillic)	FI
IBM-1165	Latin 2/Open Systems	FG
IBM-1364	Korea	KZ
IBM-1371	Taiwan	ZT
IBM-1388	China (PRC)	GV

Table 353. Supported codeset names and CC codes (continued)

Codesets	Primary Country or Territory	2-Byte CC code
IBM-1390	Japan	HU
IBM-1399	Japan	HV
IBM-4933	China (PRC)	FJ
IBM-4971	Greece	HS
IBM-13124	China (PRC)	FK
IBM-53668	Algeria, Bahrain, Egypt, Iraq, Jordan, Kuwait, Lebanon, Libya, Morocco, Oman, Qatar, Saudi Arabia, Syria, Tunisia, U.A.E., Yemen	FV
IBMEUCCN	China (PRC)	BY
IBMEUCKR	Korea	BZ
ISO8859-1	All Latin 1 Countries	I1
ISO8859-2	Croatia, Czech Republic, Hungary, Poland, Romania, Serbia (Latin), Slovakia, Slovenia	I2
ISO8859-5	Bulgaria, Macedonia, Russia, Serbia (Cyrillic)	I5
ISO8859-7	Greece	I7
ISO8859-8	Israel	I8
ISO8859-9	Turkey	I9
TIS-620	Thailand	BU
UTF-8	All Countries	F8

The exceptions to the rule above are the following special locale names, which are already recognized:

- C (EBCDIC and ASCII)
- POSIX (EBCDIC and ASCII)
- SAA (EBCDIC only)
- S370 (EBCDIC only)

The special names C, POSIX, SAA, and S370 always refer to the built-in locales, which cannot be modified. The S370 locale and the following names are for locales in an old format, created with the EDCLOC assembler macro, rather than with the localedef utility:

- GERM (EBCDIC only)
- FRAN (EBCDIC only)
- UK (EBCDIC only)
- ITAL (EBCDIC only)
- SPAI (EBCDIC only)
- USA (EBCDIC only)

The EDCLOC generated locales are not supported in AMODE 64 applications.

You can use the C macros in Table 354 on page 1004, which are defined in the locale.h header file, as synonyms for these special locale names. These macros can only be used for EBCDIC locales. The <prefix> in the Compiled locale column is

EDC for non-XPLINK locales and CEH for XPLINK locales. The C macros for the locales which list a prefix in the Compiled locales column, are not defined for AMODE 64 compilations.

*Table 354. C macros used as synonyms for special locale names*

Macro	Locale	Compiled locale
LC_C	C	Not applicable
LC_POSIX	POSIX	Not applicable
LC_C_GERMANY	"GERM"	<prefix>\$GERM
LC_C_FRANCE	"FRAN"	<prefix>\$FRAN
LC_C_UK	"UK"	<prefix>\$UK
LC_C_ITALY	"ITAL"	<prefix>\$ITAL
LC_C_SPAIN	"SPAI"	<prefix>\$SPAI
LC_C_USA	"USA"	<prefix>\$USA

The predefined name for the built-in locale in the old format is S370.

The rest of the special names refer to the EBCDIC locale objects whose names are built by prepending the letters EDC\$ for non-XPLINK locales or CEH\$ for XPLINK locales to the special name, as for EDC\$FRAN.

---

## Chapter 61. Customizing a locale

This chapter describes how you can create your own locales, based on the locale definition files supplied by IBM. See Appendix D, “Locales supplied with z/OS XL C/C++,” on page 1091 for more information on the compiled locales and locale source files. The information in this chapter applies to the format of locales based on the `localedef` utility.

The following example assumes that the target of the generated locale will be a data set, but locales may also reside in a z/OS UNIX file system (see “Locale naming conventions” on page 994 for differences in object names). In this example you will build a locale named `TEXAN` using the charmap file representing the IBM-1047 encoded character set. The locale is derived from the locale representing the English language and the cultural conventions of the United States. We will assume that non-XPLINK, XPLINK, and AMODE 64 applications will use the `TEXAN` locale. All three versions of the `TEXAN` locale will be generated.

1. See “Locale source files” on page 1111 to determine the source of the locale you are going to use. In this case, it is the English language in the United States locale, the source for which is the member `EDC$EUEY` of the PDS `CEE.SCEELOCX`.
2. Copy the member `EDC$EUEY` from PDS `CEE.SCEELOCX` to the data set `hlq.LOCALE.SOURCE` which has been pre-allocated with the same attributes as `CEE.SCEELOCX`.
3. In your new file, change the locale variables to the desired values. For example, change

```
d_t_fmt "%a %b %e %H:%M:%S %Z %Y"
to
d_t_fmt "Howdy Pardner %a %b %e %H:%M:%S %Z %Y"
```
4. This locale's Language-Territory value is `TEXAN`. The Codeset value is `IBM-1047`. `TEXAN` is not a valid PDS resident locale name in the runtime library, because it does not appear in the runtime Locale Name Table. You must modify the table to include the `TEXAN` locale. Here are the steps to follow.
  - a. Copy the member `EDC$LCNM` from PDS `CEE.SCEESAMP` to the data set `hlq.LOCALE.TABLE` which has been pre-allocated with the same attributes as `CEE.SCEESAMP`. The z/OS XL C/C++ Library uses this table to map locale code registry prefixes into two-character codes.
  - b. For this example, insert a new line into the assembler table before the last `EDCLOCNM TYPE=END` entry:

```
EDCLOCNM TYPE=ENTRY,LOCALE='TEXAN',CODESET='IBM-1047',CODE='1T'
```
5. Now that your locale name table has been modified, you must make it available to the system. Assemble the `EDC$LCNM` member and link-edit it into the `hlq.LOCALE.LOADLIB` load library with the member name `EDC$LCNM`. For our example, this is done as follows:



```

//HLASM EXEC PGM=ASMA90
//SYSPRINT DD SYSOUT=*
//SYSLIB DD DSN=SYS1.MACLIB,DISP=SHR
// DD DSN=CEE.SCEEMAC,DISP=SHR
//SYSUT1 DD UNIT=VIO,DISP=(NEW,DELETE),SPACE=(32000,(30,30))
//SYSUT2 DD UNIT=VIO,DISP=(NEW,DELETE),SPACE=(32000,(30,30))
//SYSUT3 DD UNIT=VIO,DISP=(NEW,DELETE),SPACE=(32000,(30,30))
//SYSPUNCH DD DUMMY
//SYSLIN DD DSN=<h1q>.LOCALE.OBJECT(EDC$LCNM),DISP=SHR
//SYSIN DD DSN=<h1q>.LOCALE.TABLE(EDC$LCNM),DISP=SHR
//*
//LKED EXEC EDCL,
// OUTFILE='<h1q>.LOCALE.LOADLIB(EDC$LCNM),DISP=SHR'
//LKED.SYSLIN DD DSN=<h1q>.LOCALE.OBJECT(EDC$LCNM),DISP=SHR

```

6. Generate the non-XPLINK, XPLINK and 64-bit locale objects into a load library. Note that both the XPLINK and 64-bit locale objects must be placed in a PDSE, while non-XPLINK locale objects may be in either a PDS or PDSE load library.

a. Determine the correct locale object names, using the locale naming Conventions outlined in “Locale naming conventions” on page 994. PDS resident locale object names are of the form prefixLTCC .

For this non-XPLINK locale the prefix is EDC\$, the LT code for TEXAN is 1T and the CC code for IBM-1047 is EY. The non-XPLINK object name is therefore EDC\$1TEY.

For this XPLINK locale the prefix is CEH\$. The LT and CC codes remain the same. The XPLINK object name is therefore CEH\$1TEY.

For this 64-bit locale the prefix is CEQ\$. The LT and CC codes remain the same. The 64-bit locale object name is, therefore, CEQ\$1TEY.

b. Use localedef to generate the locale objects.

- For non-XPLINK:

```

//GENLOCX EXEC PROC=EDCLDEF,
// INFILE='<h1q>.LOCALE.SOURCE(TEXAN)',
//
// OUTFILE='<h1q>.LOCALE.LOADLIB(EDC$1TEY),DISP=SHR',
// LOPT='CHARMAP(IBM-1047)'

```

- For XPLINK:

```

//GENLOCX EXEC PROC=EDCLDEF,
// INFILE='<h1q>.LOCALE.SOURCE(TEXAN)',
//
// OUTFILE='<h1q>.LOCALE.PDSE.LOADLIB(CEH$1TEY),DISP=SHR',
// LOPT='CHARMAP(IBM-1047)'

```

- For 64-bit

The batch and TSO versions of the localedef utility cannot be used to generate 64-bit locales. The UNIX Systems Services utility must be used. To do this from TSO or batch the BPXBATCH utility can be used. See *z/OS UNIX System Services Command Reference* for more information about BPXBATCH. Here, we will assume we are in a UNIX System Services shell session:

```
cp "'h1q.LOCALE.SOURCE(TEXAN)'" texan.localedef
localedef -6 -i texan.localedef -f /usr/lib/nls/charmap/IBM-1047
    TEXAN.IBM-1047.lp64
cp TEXAN.IBM-1047.lp64 "'h1q.LOCALE.PDSE.LOADLIB(CEQ$1TEY)'"
```

See *z/OS XL C/C++ User's Guide* for detailed information about the batch and TSO versions of localedef utility. The UNIX System Services version of the localedef utility is also described in *z/OS UNIX System Services Command Reference*.

**Note:** The TEXAN locale uses one of the IBM supplied CHARMAPs. If you need to customize a CHARMAP, then you must define its two-letter CC code in the Codeset Name table EDCUCSNM. This is similar to defining the locale TEXAN in EDC\$LCNM. The two-letter CHARMAP codes beginning with a number are reserved for customer use. This is the same as the convention for customer-supplied Locale Name LT codes in the Locale Name table. The CC portion of your locale object names would then change to be the new CC value you added to the Codeset Name table.

---

## Using the customized locale

Your locale objects must be made available to your program before they can be used. For PDS and PDSE resident locales, your load library must be included in your program search order. For resident locales in the z/OS UNIX file system, do one of the following:

- Copy your locales into the system default locale object directory /usr/lib/nls/locale.
- Update your LOCPATH environment variable to include the directory containing your locales.

For example, assume that the CCNGCL1 program has been compiled with LP64 into a UNIX file system executable called getlocname. Further assume that you have generated non-XPLINK, XPLINK and AMODE 64 UNIX file system resident versions of the TEXAN locale into your current directory. The following commands make TEXAN available to non-XPLINK, XPLINK and AMODE 64 applications:

```
$ ls
TEXAN.IBM-1047 TEXAN.IBM-1047.xplink TEXAN.IBM-1047.lp64 getlocname
$ export LOCPATH=$PWD
$ export LC_ALL=TEXAN.IBM-1047
$ getlocname
Default NULL locale = C
Default "" locale = /u/marcw/TEXAN.IBM-1047.lp64
$
```

If getlocname was compiled non-XPLINK then the output would look like the following:

```
$ getlocname
Default NULL locale = C
Default "" locale = /u/marcw/TEXAN.IBM-1047
$
```

If `getlocname` was compiled XPLINK then the output would look like the following:

```
$ getlocname
Default NULL locale = C
Default "" locale = /u/marcw/TEXAN.IBM-1047.xplink
$
```

The customized locale is now ready to be used in these ways:

- Explicitly referenced by name in z/OS XL C/C++ application code that uses `setlocale()` calls referring to the locale descriptive name (recommended) such as:  
`setlocale(LC_ALL, "TEXAN.IBM-1047");`  
or by a short internal name (not recommended) such as:  
`setlocale(LC_ALL, "1TEY");`
- Explicitly referenced in the z/OS XL C/C++ initialization exit, using customized setup code in `CEEBINT`.
- Implicitly specified in each user environment with environment variables.

**Note:** You cannot customize the built-in locales, `C`, `POSIX`, `SAA`, or `S370`. The locale source files `EDC$POSX` and `EDC$SAAC` are provided for reference only.

---

## Referring explicitly to a customized locale

Figure 255 shows a non-XPLINK program (`CCNGCL1`) with an explicit reference to the `TEXAN` locale.

---

```
/* this example shows how to get the local time formatted by the */
/* current locale */

#include <stdio.h>
#include <time.h>
#include <locale.h>

int main(void){
    char dest[80];
    int ch;
    time_t temp;
    struct tm *timeptr;
    temp = time(NULL);
    timeptr = localtime(&temp);
    /* Fetch default locale name */
    printf("Default empty_str locale is %s\n",setlocale(LC_ALL,""));
    ch = strftime(dest,sizeof(dest)-1,
        "Local C datetime is %c", timeptr);
    printf("%s\n", dest);

    /* Set new Texan locale name */
    printf("New locale is %s\n", setlocale(LC_ALL,"Texan.IBM-1047"));
    ch = strftime(dest,sizeof(dest)-1,
        "Texan datetime is %c ", timeptr);
    printf("%s\n", dest);

    return(0);
}
```

---

*Figure 255. Referring explicitly to a customized locale*

Compile the program. Before you execute it, ensure the load library containing the non-XPLINK version of the TEXAN locale and updated table is available. If you compile your program XPLINK, ensure the load library containing the XPLINK version of the TEXAN locale and updated Locale Name table is available. If you compile your program LP64, ensure the load library containing the 64-bit version of the TEXAN locale and updated Locale Name table is available. The output should be similar to:

```
Default empty_str locale is S370
Local C datetime is Fri Aug 20 14:58:12 1993
New locale is TEXAN
Texan datetime is Howdy Pardner Fri Aug 20 14:58:12 1993
```

For programs which are run POSIX(OFF), and which are not 64-bit programs, if the second operand to `setlocale()` had been `NULL`, rather than `""`, the default locale name returned would have been `C`.

```
setlocale(LC_ALL,"") returns "S370"
setlocale(LC_ALL,NULL) returns "C"
```

**Note:** For `setlocale(LC_ALL,"")`, the result depends on the locale-related environment variables, the POSIX runtime option, and whether the program is `AMODE 64` or not. See Chapter 63, “Definition of S370 C, SAA C, and POSIX C locales,” on page 1015 for more information about the definition of the S370 locale.

---

## Referring implicitly to a customized locale

An installation may require that a global mechanism should be used for all C programs. The exit `CEEBINT` may be used for this purpose. Users can insert a `setlocale()` call inside the routines referencing the locale required. Figure 256 shows an example program (`CCNGCL2`).

---

```
/* this example refers implicitly to a customized locale */

#ifdef __cplusplus
    extern "C"{
#else
    #pragma linkage(CEEBINT,OS)
#endif

void CEEBINT(int, int, int, int, void**, int, void**);
#pragma map(CEEBINT,"CEEBINT")

#ifdef __cplusplus
    }
#endif

#include <locale.h>
#include <stdio.h>

int main(void){
    printf("Default NULL locale = %s\n", setlocale(LC_ALL,NULL));
    printf("Default \"\" locale = %s\n", setlocale(LC_ALL,""));
}

void CEEBINT(int number, int retcode, int rsnocode, int fnccode,
             void **a_main, int userwd, void **a_exits)
{ /* user code goes here */
    printf("CEEBINT entry. number = %i\n", number);
    printf("Locale = %s\n", setlocale(LC_ALL,"Texan.IBM-1047"));
}
```

---

Figure 256. Referring implicitly to a customized locale

If the above example is compiled and executed with the TEXAN locale, the results are as follows:

```
CEEBCINT entry. number = 7
Locale = TEXAN.IBM-1047
Default NULL locale = TEXAN.IBM-1047
Default "" locale = S370
```

The exit CEEBCINT may provide a uniform way of restricting the use of customized locales across an installation. To do this, a system programmer can compile CEEBCINT separately, and link it with the application program that will use it. The disadvantage to this approach is that CEEBCINT must be link-edited into each user module explicitly. See Chapter 50, "Using runtime user exits," on page 837 for more information about user exits.

Figure 257 shows a sample program (CCNGCL3) that uses environment variables to select a locale. (For more information about setting environment variables, see Chapter 32, "Using environment variables," on page 467.)

---

```
/* this example can be used with setenv() to specify the name of a */
/* locale */

#include <locale.h>
#include <stdio.h>

int main(void){
    printf("Default NULL locale = %s\n", setlocale(LC_ALL,NULL));
    printf("Default \"\" locale = %s\n", setlocale(LC_ALL,""));

    return(0);
}
```

---

*Figure 257. Using environment variables to select a locale*

If you run this program in Figure 257 as is, without calling `setenv()`, you can expect the following result (for a 31-bit, POSIX(OFF), program ):

```
Default NULL locale = C
Default "" locale = S370
```

On the other hand, if you issue the above `setenv()` call after `main()` but before the first `printf()` statement, the `LC_ALL` variable will be set to "TEXAN.IBM-1047" and you can expect this result instead:

```
Default NULL locale = C
Default "" locale = TEXAN.IBM-1047
```

In the example above, the default NULL locale returns C because the value of `LC_ALL` does not affect the current locale until the next `setlocale(LC_ALL, "")` is done. When this call is made, the `LC_ALL` environment variable will be used and the locale will be set to TEXAN.IBM-1047.

The names of the environment variables match the names of the locale categories:

- LC\_ALL
- LC\_COLLATE
- LC\_CTYPE
- LC\_MONETARY
- LC\_NUMERIC

- LC\_TIME
- LC\_TOD
- LC\_SYNTAX

See *z/OS XL C/C++ Runtime Library Reference* for information about `setlocale()`.

## Customizing your installation

When z/OS XL C/C++ initializes its environment, it uses the C locale as its default locale. The only values that may be customized when z/OS Language Environment is installed are those defined in the TZ or \_TZ environment variable, which can override LC\_TOD category values in the default locale. Details on this customization are provided in Chapter 62, “Customizing a time zone,” on page 1013.



---

## Chapter 62. Customizing a time zone

For applications that work with local time, you can customize time zone information in the following two ways:

- TZ or \_TZ environment variable

In a distributed environment, you may have users in several time zones. Use the TZ or \_TZ environment variable to set each time zone. The user of your application can use the ENVVAR runtime option with the TZ or \_TZ environment variable to select the appropriate time zone.

For POSIX(ON) programs the TZ environment variable is used. For POSIX(OFF) programs the \_TZ environment variable is used.

When neither TZ nor \_TZ is defined, the current locale is interrogated for time zone information. If neither TZ nor \_TZ is defined and LC\_TOD time zone information is not present in the current locale, a default value is applied to local time. POSIX programs simply default to Coordinated Universal Time (UTC), while non-POSIX programs establish an offset from UTC based on the setting of the system clock.

The following functions are time zone sensitive: `ctime()`, `ctime64()`, `getdate()`, `localtime()`, `localtime64()`, `mktime()`, `mktime64()`, `strftime()`, and `tzset()`. The external variables `daylight`, `timezone`, and `tzname` and the thread specific functions `__dlight()` and `__tzone()` are also time zone sensitive. LC\_TOD category of a locale

You can customize the LC\_TOD category in a locale to a particular time zone. The LC\_TOD category binds each C/C++ locale to one time zone. For more information about customizing the LC\_TOD category, see “LC\_TOD category” on page 984 and Chapter 61, “Customizing a locale,” on page 1005.

---

### Using the TZ or \_TZ environment variable to specify time zone

The C/C++ runtime library assumes times returned by the operating system are stored using Greenwich Mean Time (GMT) or Coordinated Universal Time (UTC). This time is referred to as the universal reference time. You can use the TZ or \_TZ environment variable to specify information at run time. The C/C++ runtime library uses this information to map universal reference times to local times.

The TZ or \_TZ environment variable has the following format.

```
TZ=standardHH[:MM[:SS]]
[daylight[HH[:MM[:SS]:]]]
[,startdate[/starttime],enddate[/endtime]]]
```

The value of the TZ or \_TZ environment variable has the following five fields (two required and three optional):

#### **standard**

An alphabetic abbreviation for the local standard time zone (for example, GMT, EST, MSEZ).

#### **HH[:MM[:SS]]**

The time offset westward from the universal reference time. A leading minus sign (-) means that the local time zone is east of the universal reference time.



An offset of this form must follow *standard* and can also optionally follow *daylight*. An optional colon (:) separates hours from optional minutes and seconds.

If *daylight* is specified without a *daylight* offset, daylight savings time is assumed to be one hour ahead of the standard time.

#### [daylight]

The abbreviation for your local daylight savings time zone. If the first and third fields are identical, or if the third field is missing, daylight savings time conversion is disabled. The number of hours, minutes, and seconds your local daylight savings time is offset from UTC when daylight savings time is in effect. If the daylight savings time abbreviation is specified and the offset omitted, the offset of one hour is assumed.

#### [,startdate[/starttime],enddate[/endtime]]

A rule that identifies the start and end of daylight savings time, specifying when daylight savings time should be in effect. Both the *startdate* and *enddate* must be present and must either take the form Jn, n, or Mm.n.d where:

- Jn is the Julian day n ( $1 \leq n \leq 365$ ) and does not account for leap days.
- n is the zero-based Julian day ( $0 \leq n \leq 365$ ). Leap days are counted; therefore, you can refer to February 29th.
- For Mm.n.d, the d'th day of week n of month m of the year. Day is ( $0 \leq d \leq 6$ ), with day 0 = Sunday, day 1 = Monday, and so on. Week is ( $1 \leq n \leq 5$ ) where week 1 is the first week in which day d occurs and week 5 is the last occurrence of day d in the month (may actually be in week 4 or 5). Month is ( $1 \leq m \leq 12$ ).

Neither *starttime* nor *endtime* are required, and when omitted, their values default to 02:00:00. If this daylight savings time rule is omitted altogether, the values in the rule default to the standard American daylight savings time rules starting at 02:00:00 the second Sunday in March and ending at 02:00:00 the first Sunday in November.

---

## Relationship between TZ or \_TZ and LC\_TOD

The C/C++ runtime library uses time zone information specified by the TZ or \_TZ environment variable to convert universal reference times to local times. When neither the TZ nor \_TZ variable is defined, the C/C++ runtime library uses time zone information specified by the LC\_TOD category of the current locale to map universal reference times to local times. If LC\_TOD in the current locale has not been customized, the C/C++ runtime library uses Coordinated Universal Time (UTC) for POSIX programs or, for non-POSIX programs, the time zone of the system on which C/C++ is installed.

**Note:** The time zone external variables, *tzname*, *timezone*, and *daylight*, declarations remain feature test protected in *time.h*. Definition of these external variables are only known to the C/C++ runtime library if the z/OS UNIX System Services C/C++ signature CSECT is link edited with your C/C++ application.

---

## Chapter 63. Definition of S370 C, SAA C, and POSIX C locales

The POSIX, SAA, and S370 locales are pre-built locales used as defaults by the C runtime library. The POSIX locale complies with the standard UNIX definition and supports the z/OS UNIX environment. The SAA locale, which provides compatibility with previous releases of C/370, is consistent with the POSIX model, but varies slightly with respect to several values. The S370 locale, which is not supported for AMODE 64 applications, is compatible with an older format generated by the EDCL0C assembler macro rather than through the use of the `localedef` utility.

The POSIX definition of the C locale is described below, with the IBM extensions `LC_SYNTAX` and `LC_TOD` showing their default values.

The SAA and S370 definitions of the C locale are different from the POSIX definition; consistency with previous releases of z/OS XL C/C++ is provided for migration compatibility. The differences are described in “Differences between SAA C and POSIX C locales” on page 1021.

The relationship between the POSIX C and SAA C locales is as follows. If you are running with the runtime option `POSIX(OFF)`:

1. The SAA C locale definition is the default. "C", "SAA", and "S370" are treated as synonyms for the SAA C locale definition, which is prebuilt into the library.  
The source file `EDC$SAAC LOCALE` is provided for reference, but cannot be used to alter the definition of this prebuilt locale.
2. Issuing `setlocale(category, "")` has the following effect:
  - First, locale-related environment variables are checked for the locale name to use in setting the *category* specified. Querying the locale with `setlocale(category, NULL)` returns the name of the locales specified by the appropriate environment variables.
  - If no non-null environment variable is present, then it is the equivalent of having issued `setlocale(category, "S370")`. That is, the locale chosen is the SAA C locale definition, and querying the locale with `setlocale(category, NULL)` returns "S370" as the locale name.
3. If no `setlocale()` function is issued, or `setlocale(LC_ALL, "C")`, then the locale chosen is the pre-built SAA C locale, and querying the locale with `setlocale(category, NULL)` returns "C" as the locale name.
4. For `setlocale(LC_ALL, "SAA")`, the locale chosen is the pre-built SAA C locale, and querying the locale with `setlocale(category, NULL)` returns "SAA" as the locale name.
5. For `setlocale(LC_ALL, "S370")`, the locale chosen is the pre-built SAA C locale, and querying the locale with `setlocale(category, NULL)` returns "S370" as the locale name. AMODE 64 applications do not support the "S370" locale, and `setlocale` will fail requests for that name.
6. For `setlocale(LC_ALL, "POSIX")`, the locale chosen is the pre-built POSIX C locale, and querying the locale with `setlocale(category, NULL)` returns "POSIX" as the locale name.

If you are running with the runtime option `POSIX(ON)`:

1. The POSIX C locale definition is the default. "C" and "POSIX" are synonyms for the POSIX C locale definition, which is pre-built into the library.  
The source file EDC\$POSX LOCALE is provided for reference, but cannot be used to alter the definition of this pre-built locale.
2. Issuing `setlocale(category, "")` has the following effect:
  - Locale-related environment variables are checked to find the name of locales that can set the *category* specified. Querying the locale with `setlocale(category, NULL)` returns the name of the locale specified by the appropriate environment variables.
  - If no non-null environment variable is present, then the result is equivalent to having issued `setlocale(category, "C")`. That is, the locale chosen is the POSIX C locale definition, and querying the locale with `setlocale(category, NULL)` returns "C" as the locale name.
3. If no `setlocale()` function is issued, or if `setlocale(LC_ALL, "C")` is used, then the locale chosen is the pre-built POSIX C locale. Querying the locale with `setlocale(category, NULL)` returns "C" as the locale name.
4. For `setlocale(LC_ALL, "POSIX")`, the locale chosen is the pre-built POSIX C locale, and querying the locale with `setlocale(category, NULL)` returns "POSIX" as the locale name.
5. For `setlocale(LC_ALL, "SAA")`, the locale chosen is the pre-built SAA C locale. Querying the locale with `setlocale(category, NULL)` returns "SAA" as the locale name.
6. For `setlocale(LC_ALL, "S370")`, the locale chosen is the pre-built SAA C locale. Querying the locale with `setlocale(category, NULL)` returns "S370" as the locale name. As with `POSIX(OFF)`, AMODE 64 applications do not support the "S370" locale and `setlocale` will fail requests for that name.

The `setlocale()` function supports locales built using the `localedef` utility, as well as locales built using the assembler source and produced by the `EDCLOC` macro. However, locales built using `EDCLOC` are not supported when running AMODE 64 applications.

The `LC_TOD` category for the SAA C and POSIX C locales can be customized during installation of the library by your system programmer. See "Customizing your installation" on page 1011 for more information. The supplied default will obtain the time zone difference from the operating system. However, it will not define the daylight savings time.

The `LC_SYNTAX` category for the SAA C and POSIX C locales is set to the IBM-1047 definition of the variant characters. Figure 258 lists other locale categories for the POSIX C locale.

```

escape_char /
comment_char %

%%%%%%%%
LC_CTYPE
%%%%%%%%
% "alpha" is by default "upper" and "lower"
% "alnum" is by definition "alpha" and "digit"

```

*Additional locale categories for POSIX C (Part 1 of 6)*

*Figure 258. Additional locale categories for POSIX C*

```

% "print" is by default "alnum", "punct" and <space> character
% "punct" is by default "alnum" and "punct"

upper <A>;<B>;<C>;<D>;<E>;<F>;<G>;<H>;<I>;<J>;<K>;<L>;<M>;/
<N>;<O>;<P>;<Q>;<R>;<S>;<T>;<U>;<V>;<W>;<X>;<Y>;<Z>

lower <a>;<b>;<c>;<d>;<e>;<f>;<g>;<h>;<i>;<j>;<k>;<l>;<m>;/
<n>;<o>;<p>;<q>;<r>;<s>;<t>;<u>;<v>;<w>;<x>;<y>;<z>

digit <zero>;<one>;<two>;<three>;<four>;/
<five>;<six>;<seven>;<eight>;<nine>

space <tab>;<newline>;<vertical-tab>;<form-feed>;/
<carriage-return>;<space>

cntrl <alert>;<backspace>;<tab>;<newline>;<vertical-tab>;/
<form-feed>;<carriage-return>;/
<NUL>;<SOH>;<STX>;<ETX>;<EOT>;<ENQ>;<ACK>;<SO>;/
<SI>;<DLE>;<DC1>;<DC2>;<DC3>;<DC4>;<NAK>;<SYN>;/
<ETB>;<CAN>;<EM>;<SUB>;<ESC>;<IS4>;<IS3>;<IS2>;/
<IS1>;<DEL>

punct <exclamation-mark>;<quotation-mark>;<number-sign>;/
<dollar-sign>;<percent-sign>;<ampersand>;<apostrophe>;/
<left-parenthesis>;<right-parenthesis>;<asterisk>;/
<plus-sign>;<comma>;<hyphen>;<period>;<slash>;/
<colon>;<semicolon>;<less-than-sign>;<equals-sign>;/
<greater-than-sign>;<question-mark>;<commercial-at>;/
<left-square-bracket>;<backslash>;<right-square-bracket>;/
<circumflex>;<underscore>;<grave-accent>;/
<left-curly-bracket>;<vertical-line>;<right-curly-bracket>;<tilde>

xdigit <zero>;<one>;<two>;<three>;<four>;/
<five>;<six>;<seven>;<eight>;<nine>;/
<A>;<B>;<C>;<D>;<E>;<F>;/
<a>;<b>;<c>;<d>;<e>;<f>

blank <space>;/
<tab>

toupper (<a>, <A>); (<b>, <B>); (<c>, <C>); (<d>, <D>); (<e>, <E>);/
(<f>, <F>); (<g>, <G>); (<h>, <H>); (<i>, <I>); (<j>, <J>);/
(<k>, <K>); (<l>, <L>); (<m>, <M>); (<n>, <N>); (<o>, <O>);/
(<p>, <P>); (<q>, <Q>); (<r>, <R>); (<s>, <S>); (<t>, <T>);/
(<u>, <U>); (<v>, <V>); (<w>, <W>); (<x>, <X>); (<y>, <Y>);/
(<z>, <Z>)

tolower (<A>, <a>); (<B>, <b>); (<C>, <c>); (<D>, <d>); (<E>, <e>);/
(<F>, <f>); (<G>, <g>); (<H>, <h>); (<I>, <i>); (<J>, <j>);/
(<K>, <k>); (<L>, <l>); (<M>, <m>); (<N>, <n>); (<O>, <o>);/
(<P>, <p>); (<Q>, <q>); (<R>, <r>); (<S>, <s>); (<T>, <t>);/
(<U>, <u>); (<V>, <v>); (<W>, <w>); (<X>, <x>); (<Y>, <y>);/
(<Z>, <z>)

END LC_CTYPE

%%%%%%%%%%
LC_COLLATE
%%%%%%%%%%

order_start
% ASCII Control characters
<NUL>
<SOH>
<STX>
<ETX>
<EOT>

```

*Additional locale categories for POSIX C (Part 2 of 6)*

<ENQ>  
<ACK>  
<alert>  
<backspace>  
<tab>  
<newline>  
<vertical-tab>  
<form-feed>  
<carriage-return>  
<S0>  
<SI>  
<DLE>  
<DC1>  
<DC2>  
<DC3>  
<DC4>  
<NAK>  
<SYN>  
<ETB>  
<CAN>  
<EM>  
<SUB>  
<ESC>  
<IS4>  
<IS3>  
<IS2>  
<IS1>  
<space>  
<exclamation-mark>  
<quotation-mark>  
<number-sign>  
<dollar-sign>  
<percent-sign>  
<ampersand>  
<apostrophe>  
<left-parenthesis>  
<right-parenthesis>  
<asterisk>  
<plus-sign>  
<comma>  
<hyphen>  
<period>  
<slash>  
<zero>  
<one>  
<two>  
<three>  
<four>  
<five>  
<six>  
<seven>  
<eight>  
<nine>  
<colon>  
<semicolon>  
<less-than-sign>  
<equals-sign>  
<greater-than-sign>  
<question-mark>  
<commercial-at>  
<A>  
<B>  
<C>  
<D>  
<E>  
<F>  
<G>

*Additional locale categories for POSIX C (Part 3 of 6)*

```

<H>
<I>
<J>
<K>
<L>
<M>
<N>
<O>
<P>
<Q>
<R>
<S>
<T>
<U>
<V>
<W>
<X>
<Y>
<Z>
<left-square-bracket>
<backslash>
<right-square-bracket>
<circumflex>
<underscore>
<grave-accent>
<a>
<b>
<c>
<d>
<e>
<f>
<g>
<h>
<i>
<j>
<k>
<l>
<m>
<n>
<o>
<p>
<q>
<r>
<s>
<t>
<u>
<v>
<w>
<x>
<y>
<z>
<left-curly-bracket>
<vertical-line>
<right-curly-bracket>
<tilde>
<DEL>
order_end

END LC_COLLATE

%%%%%%%%%%
LC_MONETARY
%%%%%%%%%%

int_curr_symbol ""
currency_symbol ""
mon_decimal_point ""
mon_thousands_sep ""
mon_grouping ""

```

*Additional locale categories for POSIX C (Part 4 of 6)*

```

positive_sign      ""
negative_sign     ""
int_frac_digits   -1
frac_digits       -1
p_cs_precedes     -1
p_sep_by_space    -1
n_cs_precedes     -1
n_sep_by_space    -1
p_sign_posn       -1
n_sign_posn       -1

END LC_MONETARY

%%%%%%%%%%%%%%
LC_NUMERIC
%%%%%%%%%%%%%%

decimal_point     "<period>"
thousands_sep    ""
grouping          ""

END LC_NUMERIC

%%%%%%%%%%%%%%
LC_TIME
%%%%%%%%%%%%%%

abday             "<S><u><n>" ;/
                 "<M><o><n>" ;/
                 "<T><u><e>" ;/
                 "<W><e><d>" ;/
                 "<T><h><u>" ;/
                 "<F><r><i>" ;/
                 "<S><a><t>"

day              "<S><u><n><d><a><y>" ;/
                 "<M><o><n><d><a><y>" ;/
                 "<T><u><e><s><d><a><y>" ;/
                 "<W><e><d><n><e><s><d><a><y>" ;/
                 "<T><h><u><r><s><d><a><y>" ;/
                 "<F><r><i><d><a><y>" ;/
                 "<S><a><t><u><r><d><a><y>"

abmon            "<J><a><n>" ;/
                 "<F><e><b>" ;/
                 "<M><a><r>" ;/
                 "<A><p><r>" ;/
                 "<M><a><y>" ;/
                 "<J><u><n>" ;/
                 "<J><u><l>" ;/
                 "<A><u><g>" ;/
                 "<S><e><p>" ;/
                 "<O><c><t>" ;/
                 "<N><o><v>" ;/
                 "<D><e><c>"

mon             "<J><a><n><u><a><r><y>" ;/
                 "<F><e><b><r><u><a><r><y>" ;/
                 "<M><a><r><c><h>" ;/
                 "<A><p><r><i><l>" ;/
                 "<M><a><y>" ;/
                 "<J><u><n><e>" ;/

```

*Additional locale categories for POSIX C (Part 5 of 6)*

```

"<J><u><l><y>";/
"<A><u><g><u><s><t>";/
"<S><e><p><t><e><m><b><e><r>";/
"<O><c><t><o><b><e><r>";/
"<N><o><v><e><m><b><e><r>";/
"<D><e><c><e><m><b><e><r>"

% equivalent of AM/PM (%p)
am_pm      "<A><M>";"<P><M>"

% appropriate date and time representation (%c) "%a %b %e %H:%M:%S %Y"
d_t_fmt    "<percent-sign><a><space><percent-sign><b><space><percent-sign><e>/
<space><percent-sign><H><colon><percent-sign><M>/
<colon><percent-sign><S><space><percent-sign><Y>"

% appropriate date representation (%x) "%m/%d/%y"
d_fmt      "<percent-sign><m><slash><percent-sign><d><slash><percent-sign><y>"

% appropriate time representation (%X) "%H:%M:%S"
t_fmt      "<percent-sign><M><colon><percent-sign><M><colon><percent-sign><S>"

% appropriate 12-hour time representation (%r) "%I:%M:%S %p"
t_fmt_ampm "<percent-sign><I><colon><percent-sign><M><colon><percent-sign><S>/
<space><percent-sign><p>"

END LC_TIME

%%%%%%%%%%
LC_MESSAGES
%%%%%%%%%%

yesexpr "<circumflex><left-square-bracket><y><Y><right-square-bracket>"
noexpr  "<circumflex><left-square-bracket><n><N><right-square-bracket>"

END LC_MESSAGES

```

*Additional locale categories for POSIX C (Part 6 of 6)*

---

## Differences between SAA C and POSIX C locales

In fact, there are three built-in locales, S370 C, SAA C, and POSIX C. The default locale at your site depends on the system that is running the application. Issuing `setlocale(LC_ALL, "")` sets the default, based on the current environment. Issuing `setlocale(LC_ALL, "SAA")` sets the SAA C locale, even when you are running with the `POSIX(ON)` runtime option. Likewise, `setlocale(LC_ALL, "POSIX")` sets the POSIX locale.

If you are running in a C locale, one way you can determine if the SAA C or the POSIX locale is in effect is to check if the cent sign (¢ at X'4A') is defined as a punctuation character. Under the default POSIX support, the cent sign is not part of the POSIX portable character set. Figure 259 on page 1022 (sample CCNGDL1) shows how to perform this test.



---

```

/* this example shows how to determine whether the SAA C or POSIX */
/* locale is in effect */

#include <stdio.h>
#include <ctype.h>
int main(void)
{
    if (ispunct(0x4A)) {
        printf(" cent sign is punct\n");
        printf(" current locale is SAA- or S370-like\n");
    }
    else {
        printf(" cent sign is not punct\n");
        printf(" default locale is POSIX-like\n");
    }
    return(0);
}

```

---

Figure 259. Determining which locale is in effect

Under the SAA or System/370 default locales, the lowercase letters collate before the uppercase letters; under the POSIX definition, the lowercase letters collate after the uppercase letters. The locale "" is the same locale as the one obtained from `setlocale(LC_ALL, "")`. For more detail on these special environment variables, see Chapter 32, "Using environment variables," on page 467. Other differences between the SAA C locale and the POSIX C locale are as follows:

**<mb\_cur\_max>**

The POSIX C locale is built using coded character set IBM-1047, with <mb\_cur\_max> as 1. The SAA C locale is built using coded character set IBM-1047, with <mb\_cur\_max> as 4.

**The cent sign**

In the default POSIX support, the cent sign (¢) is *not* part of the POSIX portable character set; in the SAA locale, it *is* defined as a punctuation character.

**Collation weight by case**

In the POSIX definition, the lowercase letters collate *after* the uppercase letters; in the SAA or System/370 default locales, the lowercase letters collate *before* the uppercase letters.

**LC\_CTYPE category**

The SAA C locale has all the EBCDIC control characters defined in the 'cntrl' class. The POSIX C locale has only the ASCII control characters in the 'cntrl' class. The SAA C locale includes ¢ (the cent character) and ¦ (the broken vertical line) as 'punct' characters. The POSIX C locale does not group these characters as 'punct' characters.

**LC\_COLLATE category**

The default collation for the SAA C locale is the EBCDIC sequence. The POSIX C locale uses the ASCII collation sequence; the first 128 ASCII characters are defined in the collation sequence, and the remaining EBCDIC characters are at the end of the collating sequence.

**LC\_TIME category**

The SAA C locale uses the date and time format (d\_t\_fmt) as "%Y/%M/%D %X"; the POSIX C locale uses "%a %b %d %H/%M/%S %Y". The SAA C locale uses the strings "am" and "pm"; the POSIX C locale uses "AM" and "PM".

---

## Chapter 64. Code set conversion utilities

This chapter describes the code set conversion utilities supported by the z/OS XL C/C++ compiler. These utilities are as follows:

### **genxlt utility**

Generates a translation table for use by the iconv utility and iconv() functions.

### **iconv utility**

Converts a file from one code set encoding to another.

### **iconv() functions**

Perform code set translation. These functions are iconv\_open(), iconv(), and iconv\_close(). They are used by the iconv utility and may be called from any z/OS XL C/C++ program requiring code set translation.

### **uconvdef utility**

Handles Universal-coded character sets. Creates binary conversion tables that define mapping between UCS-2 and multibyte code sets.

See *z/OS XL C/C++ User's Guide* for descriptions of the genxlt and iconv utilities, *z/OS XL C/C++ Runtime Library Reference* for descriptions of the iconv() functions, and *z/OS MVS Program Management: User's Guide and Reference, SA23-1393* for descriptions of the uconvdef utility.

---

## The genxlt utility

The genxlt utility reads a source translation file from InputFile, writes the compiled version to OutputFile, and then generates the translation load module. The source translation file provides the conversion specification from fromCodeSet to toCodeSet. The source translation file contains directives that are acted upon by the genxlt utility to produce the compiled version of the translation table.

The name of the conversion programs have the following naming conventions:

- The name starts with a four letter prefix. The prefix is EDCU for non-XPLINK converters, CEHU for XPLINK converters, and CEQU for AMODE 64 converters.
- The prefix is followed by the two-letter CC code that corresponds to the CodesetRegistry.CodesetEncoding name of the fromCodeSet defined in the Table 353 on page 1001.
- The first CC code is followed by the two-letter CC code than corresponds to the CodesetRegistry.CodesetEncoding name of the toCodeSet defined in the Table 353 on page 1001.

To generate your own conversions, you must modify the codeset name table EDCUCSNM with the macros described in "Locale naming conventions" on page 994. For descriptions of the genxlt and iconv utilities, refer to *z/OS XL C/C++ User's Guide*. There is also a UNIX System Services iconv utility, which is described in *z/OS UNIX System Services Command Reference*.

---

## The iconv utility

The iconv utility reads characters from the input file, converts them from fromCodeSet encoding to toCodeSet encoding, and writes them to the output file.

The conversion is performed by the code conversion functions of the runtime library. They are described in "Code conversion functions." The tables used are determined by the CC codes of the fromCodeSet and toCodeSet appended to the four-character prefix. The prefix is EDCU for non-XPLINK converters, CEHU for XPLINK converters, and CEQU for AMODE 64 converters. See *z/OS XL C/C++ User's Guide* for descriptions of the genxlt and iconv utilities. There is also a UNIX System Services iconv utility, which is described in *z/OS UNIX System Services Command Reference*.

The iconv utility can also perform bidirectional layout transformation (such as shaping and reordering) while converting from fromCodeSet to toCodeSet according to the value of an environment variable called \_BIDION. The value of this variable is either set to TRUE to activate the BiDi layout transformation or FALSE to prevent the bidirectional layout transformation. If this variable is not defined in the environment it defaults to FALSE. The \_BIDIATTR environment variable can be used to contain the bidirectional attributes (for information on bidirectional layout transformation see Chapter 66, "Bidirectional language support," on page 1065) which will determine the way the bidirectional transformation takes place. These two environment variables are described in Chapter 32, "Using environment variables," on page 467.

---

## Code conversion functions

The iconv\_open(), iconv(), and iconv\_close() library functions can be called from C or C++ source to initialize and perform the characters conversions from one character set encoding to another.

The iconv() family of functions has been modified to utilize character conversion services provided by Unicode Services. The iconv\_open(), iconv(), and iconv\_close() function interfaces remain unchanged except for the addition of the following:

- Four new errno values - ECUNNOENV, ECUNNOCONV, ECUNNOTALIGNED, and ECUNERR
- Two new environment variables - \_ICONV\_MODE and \_ICONV\_TECHNIQUE

For more information about these errno values and environment variables, see the iconv\_open() function description in *z/OS XL C/C++ Runtime Library Reference*.

There are differences in externals between the iconv() family of functions and Unicode Services. However, the differences in externals are managed by the iconv() family of functions except where noted in the C/C++ Migration Guide for Application Developers. All conversions listed in Table 356 on page 1027 and Table 357 on page 1037 will continue to work as they do today. However, Unicode Services supports conversions between thousands of additional character sets not listed in Table 356 on page 1027 and Table 357 on page 1037. A complete list of conversions supported by Unicode Services can be found in EBCDIC Conversion Table, ASCII Conversion Table, and Unicode Conversion Table in *z/OS Unicode Services User's Guide and Reference*. To set up a conversion using iconv\_open() for any of the character sets listed in EBCDIC Conversion Table, ASCII Conversion Table, and Unicode Conversion Table, use a character string representing the CCSID's for fromcode/tocode. For example, to set up a conversion from CCSID 00256 to CCSID 00870 using conversion technique R, you need to set the \_ICONV\_TECHNIQUE environment variable to R and call iconv\_open() as follows:

```
cd = iconv_open("00870", "00256");
```

and continue to use iconv() and iconv\_close() as in previous releases.

## **\_ICONV\_MODE environmental variable**

The `_ICONV_MODE` environmental variable selects the behavior mode for the `iconv_open()`, `iconv()`, and `iconv_close()` family of functions. The `_ICONV_MODE` value can be set to:

- C** Users have created their own `iconv()` converter(s). Search for user created converters first. If the user-created converter is not located, try using Unicode Conversion Services to perform the conversion.

**Note:** `_ICONV_UCS2` and `_ICONV_PREFIX` environment variables will be honored while searching for user-created converters, but they will not be honored while using Unicode Conversion Services.

- U** Use Unicode Conversion Services to perform all conversions not listed in the Table 356 on page 1027. This is the default value for `_ICONV_MODE`. The values of the `_ICONV_UCS2` and `_ICONV_PREFIX` will not be honored.

## **\_ICONV\_TECHNIQUE environmental variable**

The `_ICONV_TECHNIQUE` environmental variable is the technique value used by Unicode Conversion Services. For more information regarding the Unicode conversion Services value, see *z/OS Unicode Services User's Guide and Reference*. `_ICONV_TECHNIQUE` can be set to one of the following values:

- R** Roundtrip conversion; roundtrip conversions between two CCSIDs assure that all characters making the roundtrip arrive as they were originally.
- E** Enforced subset conversion; enforced subset conversions map only those characters from one CCSID to another that have a corresponding character in the second CCSID. All other characters are replaced by a substitution character.
- C** Customized conversion; customized conversions use conversion tables that have been created to address some special requirements. Note that these customized conversion tables refer to Unicode Conversion Services customized tables, not user-supplied `iconv()` style conversion tables.
- L** Language Environment-Behavior conversion; Language Environment-Behavior conversions use tables that map characters like the `iconv()` function of the Language Environment runtime Library does. These conversions differ from others primarily in their mapping of the EBCDIC newline (NL) character to ASCII and Unicode linefeed (LF).
- M** Modified Language Environment-Behavior conversion; Modified Language Environment-Behavior conversions use tables that map characters like the `iconv()` function of the Language Environment runtime library does for converters ending with C; for example IBM-932C.
- 0-9** User-defined conversions. See Appendix C, "Defining CCSIDs and conversion tables" in the *z/OS Unicode Services User's Guide and Reference*.

This refers to user defined tables for Unicode Conversion Services and should not be confused with user-defined converters for the Language Environment's `iconv()` function.

### **Notes:**

1. You can specify more than one value for `_ICONV_TECHNIQUE`; the values will be tried in the order specified. For example, if a value of CE were specified as the `_ICONV_TECHNIQUE`, a converter using the Unicode Conversion

Services technique of C will be searched for first. If it does not exist, a converter using the Unicode Conversion Services technique of E will be searched for.

2. If a value is not specified for the `_ICONV_TECHNIQUE` environment variable, a default value of `LMREC` will be used.

---

## Code set converters supplied

A set of code set converters is provided in the National Language Resources component of z/OS Language Environment. Consult your system programmer to see if this component has been installed on your system. Figure 260 shows the converters.

---

Round Trip Conversions(RTC) or Customized  
Round Trip Conversions(C-RTC), which means round trip with exceptions.

Conversions:

```
Latin-1 EBCDIC      to/from Latin-1 EBCDIC: RTC
Non-Latin-1 EBCDIC to/from Latin-1 EBCDIC: RTC
Latin-1 ASCII      to/from Latin-1 EBCDIC: C-RTC
Non_latin-1 ASCII  to/from Latin-1 EBCDIC: C-RTC
```

Example of Customized Round Trip Conversions(C-RTC) is  
IBM-850 to/from IBM-1047 conversion.

Customized Round Trip Conversion

```
      IBM-850      IBM-1047
Code Point  Code Point
  0A  <->   15
  DA   ->   3F
  0A  <-   25
```

---

*Figure 260. Supplied code set converters*

The code set converters that are provided as programs are shown in Table 356 on page 1027. The GENXLT source for the code set converters are shipped in the CEE.SCEEGXLT data set.

### Notes:

1. Table 355 shows the <prefix> values that appear in the Program Name column of Table 356 on page 1027.

*Table 355. Referencing data types*

Converter	Prefix
31-bit	EDCU
31-bit XPLINK	CEHU
AMODE 64	CEQU

2. Specify `IBM-932C` or `IBM-eucJC` as the `iconv_open()` source or target code set name to set up for conversion of POSIX data encoded by `IBM-932` or `IBM-eucJP` to or from a host code set encoding of the data such as `IBM-930` or `IBM-939`.

Examples of POSIX data are C/C++ source and shell scripts. The data includes characters from the POSIX character set. The names `IBM-932C` and `IBM-eucJC` indicate that the <yen> and <overline> characters in POSIX data encoded by `IBM-932` or `IBM-eucJP` map to the <backslash> and <tilde> characters, respectively, when the data is converted to or from host encodings.

**CAUTION:**

The naming conventions provided for building genxlt conversion tables allow the iconv interfaces to recognize the converters. All genxlt conversion tables, whether customized or shipped in z/OS Language Environment, are intended for use with the C/C++ iconv interfaces or the iconv utility. Direct programming to these tables is not supported and will produce unpredictable results.

IBM makes no guarantee that converter binaries or source shipped with z/OS Language Environment will continue to be shipped in future releases. For a complete list of names and aliases removed in z/OS V1R9, go to the following URL: [http://www-03.ibm.com/systems/z/os/zos/features/lang\\_environment/assist/support/pk65279.html](http://www-03.ibm.com/systems/z/os/zos/features/lang_environment/assist/support/pk65279.html)

UCS-2 converters, still shipped with z/OS Language Environment in z/OS V1R9, are removed in z/OS V1R11. See “Universal coded character set converters” on page 1035 for more information.

Starting in z/OS V1R12, the C/C++ Runtime Library will not ship the genxlt source for character conversions performed by Unicode Services. However, if you require the affected genxlt converters and plan to build them by creating your own source or by migrating source from a prior release, you must continue to name them as shown in Table 356. For more details, refer to “The genxlt utility” on page 1023.

Table 356. Coded character set conversion tables

FromCode	ToCode	GENXLT source shipped	Program Name
IBM-858	IBM-1047	Yes	<prefix>AIEY
IBM-858	IBM-1140	Yes	<prefix>AIHA
IBM-858	IBM-1141	Yes	<prefix>AIHB
IBM-858	IBM-1142	Yes	<prefix>AIHE
IBM-858	IBM-1143	Yes	<prefix>AIHF
IBM-858	IBM-1144	Yes	<prefix>AIHG
IBM-858	IBM-1145	Yes	<prefix>AIHJ
IBM-858	IBM-1146	Yes	<prefix>AIHK
IBM-858	IBM-1147	Yes	<prefix>AIHM
IBM-858	IBM-1148	Yes	<prefix>AIHO
IBM-858	IBM-1149	Yes	<prefix>AIHR
IBM-037	IBM-924	Yes	<prefix>EAEZ
IBM-273	IBM-924	Yes	<prefix>EBEZ
IBM-278	IBM-924	Yes	<prefix>EFEZ
IBM-280	IBM-924	Yes	<prefix>EGEZ
IBM-284	IBM-924	Yes	<prefix>EJEZ
IBM-285	IBM-924	Yes	<prefix>EKEZ
IBM-297	IBM-924	Yes	<prefix>EMEZ
IBM-500	IBM-924	Yes	<prefix>EOEZ
IBM-871	IBM-924	Yes	<prefix>EREZ
IBM-1047	IBM-858	Yes	<prefix>EYAI
IBM-1047	IBM-923	Yes	<prefix>EYEZ

Table 356. Coded character set conversion tables (continued)

FromCode	ToCode	GENXLT source shipped	Program Name
IBM-924	IBM-037	Yes	<prefix>EZEA
IBM-924	IBM-273	Yes	<prefix>EZEB
IBM-924	IBM-278	Yes	<prefix>EZEF
IBM-924	IBM-280	Yes	<prefix>EZEG
IBM-924	IBM-284	Yes	<prefix>EZEJ
IBM-924	IBM-285	Yes	<prefix>EZEK
IBM-924	IBM-297	Yes	<prefix>EZEM
IBM-924	IBM-500	Yes	<prefix>EZEO
IBM-924	IBM-871	Yes	<prefix>EZER
IBM-923	IBM-1047	Yes	<prefix>EZEY
IBM-924	IBM-1140	Yes	<prefix>EZHA
IBM-924	IBM-1141	Yes	<prefix>EZHB
IBM-924	IBM-1142	Yes	<prefix>EZHE
IBM-924	IBM-1143	Yes	<prefix>EZHF
IBM-924	IBM-1144	Yes	<prefix>EZHG
IBM-924	IBM-1145	Yes	<prefix>EZHJ
IBM-924	IBM-1146	Yes	<prefix>EZHK
IBM-924	IBM-1147	Yes	<prefix>EZHM
IBM-924	IBM-1148	Yes	<prefix>EZHO
IBM-924	IBM-1149	Yes	<prefix>EZHR
IBM-924	IBM-4971	Yes	<prefix>EZHS
IBM-924	IBM-923	Yes	<prefix>EZIF
IBM-1140	IBM-858	Yes	<prefix>HAAI
IBM-1140	IBM-924	Yes	<prefix>HAEZ
IBM-1141	IBM-858	Yes	<prefix>HBAI
IBM-1141	IBM-924	Yes	<prefix>HBEZ
IBM-1142	IBM-858	Yes	<prefix>HEAI
IBM-1142	IBM-924	Yes	<prefix>HEEZ
IBM-1143	IBM-858	Yes	<prefix>HFAI
IBM-1143	IBM-924	Yes	<prefix>HFEZ
IBM-1144	IBM-858	Yes	<prefix>HGAI
IBM-1144	IBM-924	Yes	<prefix>HGEZ
IBM-1145	IBM-858	Yes	<prefix>HJAI
IBM-1145	IBM-924	Yes	<prefix>HJEZ
IBM-1146	IBM-858	Yes	<prefix>HKAI
IBM-1146	IBM-924	Yes	<prefix>HKEZ
IBM-1147	IBM-858	Yes	<prefix>HMAI
IBM-1147	IBM-924	Yes	<prefix>HMEZ
IBM-1148	IBM-858	Yes	<prefix>HOAI
IBM-1148	IBM-924	Yes	<prefix>HOEZ



Table 356. Coded character set conversion tables (continued)

FromCode	ToCode	GENXLT source shipped	Program Name
IBM-1149	IBM-858	Yes	<prefix>HRAI
IBM-1149	IBM-924	Yes	<prefix>HREZ
IBM-4971	IBM-924	Yes	<prefix>HSEZ
IBM-4971	IBM-4909	Yes	<prefix>HSIA
IBM-4909	IBM-4971	Yes	<prefix>IAHS
IBM-923	IBM-924	Yes	<prefix>IFEZ
IBM-850	IBM-037	No	<prefix>AAEA
IBM-850	IBM-273	No	<prefix>AAEB
IBM-850	IBM-277	No	<prefix>AAEE
IBM-850	IBM-278	No	<prefix>AAEF
IBM-850	IBM-280	No	<prefix>AAEG
IBM-850	IBM-284	No	<prefix>AAEJ
IBM-850	IBM-285	No	<prefix>AAEK
IBM-850	IBM-297	No	<prefix>AAEM
IBM-850	IBM-500	No	<prefix>AAEO
IBM-850	IBM-871	No	<prefix>AAER
IBM-850	IBM-1047	No	<prefix>AAEY
IBM-850	IBM-1140	No	<prefix>AAHA
IBM-850	IBM-1141	No	<prefix>AAHB
IBM-850	IBM-1142	No	<prefix>AAHE
IBM-850	IBM-1143	No	<prefix>AAHF
IBM-850	IBM-1144	No	<prefix>AAHG
IBM-850	IBM-1145	No	<prefix>AAHJ
IBM-850	IBM-1146	No	<prefix>AAHK
IBM-850	IBM-1147	No	<prefix>AAHM
IBM-850	IBM-1148	No	<prefix>AAHO
IBM-850	IBM-1149	No	<prefix>AAHR
IBM-932	IBM-290	No	<prefix>ABEL
IBM-932	IBM-1027	No	<prefix>ABEX
IBM-932C	IBM-290	No	<prefix>AGEL
IBM-932C	IBM-1027	No	<prefix>AGEX
IBM-1254	IBM-1026	No	<prefix>DIEW
IBM-037	IBM-850	No	<prefix>EAAA
IBM-037	IBM-500	Yes	<prefix>EAEO
IBM-037	IBM-1047	Yes	<prefix>EAEY
IBM-037	ISO8859-1	No	<prefix>EAI1
IBM-273	IBM-850	No	<prefix>EBAA
IBM-273	IBM-500	Yes	<prefix>EBEO
IBM-273	IBM-1047	Yes	<prefix>EBEY
IBM-273	ISO8859-1	No	<prefix>EBI1



Table 356. Coded character set conversion tables (continued)

FromCode	ToCode	GENXLT source shipped	Program Name
IBM-274	IBM-500	Yes	<prefix>ECEO
IBM-274	IBM-1047	Yes	<prefix>ECEY
IBM-274	IBM-1148	Yes	<prefix>ECHO
IBM-274	IBM-819	No	<prefix>ECI1
IBM-275	IBM-500	Yes	<prefix>EDEO
IBM-275	IBM-1047	Yes	<prefix>EDEY
IBM-275	IBM-1148	Yes	<prefix>EDHO
IBM-275	IBM-819	No	<prefix>EDI1
IBM-277	IBM-850	No	<prefix>EEAA
IBM-277	IBM-500	Yes	<prefix>EEEE
IBM-277	IBM-1047	Yes	<prefix>EEEY
IBM-277	ISO8859-1	No	<prefix>EEI1
IBM-278	IBM-850	No	<prefix>EFAA
IBM-278	IBM-500	Yes	<prefix>EFEO
IBM-278	IBM-924	Yes	<prefix>EFEY
IBM-278	ISO8859-1	No	<prefix>EFI1
IBM-280	IBM-850	No	<prefix>EGAA
IBM-280	IBM-500	Yes	<prefix>EGEO
IBM-280	IBM-1047	Yes	<prefix>EGEY
IBM-280	ISO8859-1	No	<prefix>EGI1
IBM-281	IBM-500	Yes	<prefix>EHEO
IBM-281	IBM-1047	Yes	<prefix>EHEY
IBM-281	IBM-1148	Yes	<prefix>EHHO
IBM-281	ISO8859-1	No	<prefix>EHI1
IBM-282	IBM-500	Yes	<prefix>EIEO
IBM-282	IBM-1047	Yes	<prefix>EIEY
IBM-282	IBM-1148	Yes	<prefix>EIHO
IBM-282	ISO8859-1	Yes	<prefix>EII1
IBM-284	IBM-850	No	<prefix>EJAA
IBM-284	IBM-500	Yes	<prefix>EJEO
IBM-284	IBM-1047	Yes	<prefix>EJEY
IBM-284	ISO8859-1	No	<prefix>EJI1
IBM-285	IBM-850	No	<prefix>EKAA
IBM-285	IBM-500	Yes	<prefix>EKEO
IBM-285	IBM-1047	Yes	<prefix>EKEY
IBM-285	ISO8859-1	No	<prefix>EKI1
IBM-290	IBM-932	No	<prefix>ELAB
IBM-290	IBM-932C	No	<prefix>ELAG
IBM-290	IBM-500	Yes	<prefix>ELEO
IBM-290	IBM-1027	Yes	<prefix>ELEX

Table 356. Coded character set conversion tables (continued)

FromCode	ToCode	GENXLT source shipped	Program Name
IBM-290	IBM-1047	Yes	<prefix>ELEY
IBM-290	IBM-1148	Yes	<prefix>ELHO
IBM-290	IBM-819	No	<prefix>ELI1
IBM-297	IBM-850	No	<prefix>EMAA
IBM-297	IBM-500	Yes	<prefix>EMEO
IBM-297	IBM-1047	Yes	<prefix>EMEY
IBM-297	ISO8859-1	No	<prefix>EMI1
IBM-500	IBM-850	No	<prefix>EOAA
IBM-500	IBM-037	Yes	<prefix>EOEA
IBM-500	IBM-273	Yes	<prefix>EOEB
IBM-500	IBM-274	Yes	<prefix>EOEC
IBM-500	IBM-275	Yes	<prefix>EOED
IBM-500	IBM-277	Yes	<prefix>EOEE
IBM-500	IBM-278	Yes	<prefix>EOEF
IBM-500	IBM-280	Yes	<prefix>EOEG
IBM-500	IBM-281	Yes	<prefix>EOEH
IBM-500	IBM-282	Yes	<prefix>EOEI
IBM-500	IBM-284	Yes	<prefix>EOEJ
IBM-500	IBM-285	Yes	<prefix>EOEK
IBM-500	IBM-290	Yes	<prefix>EOEL
IBM-500	IBM-297	Yes	<prefix>EOEM
IBM-500	IBM-871	Yes	<prefix>EOER
IBM-500	IBM-1027	Yes	<prefix>EOEX
IBM-500	IBM-1047	Yes	<prefix>EOEY
IBM-500	IBM-1140	Yes	<prefix>EOHA
IBM-500	IBM-1141	Yes	<prefix>EOHB
IBM-500	IBM-1142	Yes	<prefix>EOHE
IBM-500	IBM-1143	Yes	<prefix>EOHF
IBM-500	IBM-1144	Yes	<prefix>EOHG
IBM-500	IBM-1145	Yes	<prefix>EOHJ
IBM-500	IBM-1146	Yes	<prefix>EOHK
IBM-500	IBM-1147	Yes	<prefix>EOHM
IBM-500	IBM-1149	Yes	<prefix>EOHR
IBM-500	ISO8859-1	No	<prefix>EOI1
IBM-871	IBM-850	No	<prefix>ERAA
IBM-871	IBM-500	Yes	<prefix>EREO
IBM-871	IBM-1047	Yes	<prefix>EREY
IBM-871	IBM-924	No	<prefix>ERI1
IBM-871	ISO8859-1	Yes	<prefix>ESEY
IBM-875	ISO8859-7	No	<prefix>ESI7

Table 356. Coded character set conversion tables (continued)

FromCode	ToCode	GENXLT source shipped	Program Name
IBM-930	IBM-1047	Yes	<prefix>EUEY
IBM-939	IBM-1047	Yes	<prefix>EVEY
IBM-1026	IBM-1254	No	<prefix>EWDI
IBM-1026	IBM-1047	Yes	<prefix>EWEY
IBM-1026	ISO8859-9	No	<prefix>EWI9
IBM-1027	IBM-932	No	<prefix>EXAB
IBM-1027	IBM-932C	No	<prefix>EXAG
IBM-1027	IBM-290	Yes	<prefix>EXEL
IBM-1027	IBM-500	Yes	<prefix>EXEO
IBM-1027	IBM-1047	Yes	<prefix>EXEY
IBM-1027	IBM-1148	Yes	<prefix>EXHO
IBM-1027	ISO8859-1	No	<prefix>EXI1
IBM-1047	IBM-850	No	<prefix>EYAA
IBM-1047	IBM-037	Yes	<prefix>EYEA
IBM-1047	IBM-273	Yes	<prefix>EYEB
IBM-1047	IBM-274	Yes	<prefix>EYEC
IBM-1047	IBM-275	Yes	<prefix>EYED
IBM-1047	IBM-277	Yes	<prefix>EYEE
IBM-1047	IBM-278	Yes	<prefix>EYEF
IBM-1047	IBM-280	Yes	<prefix>EYEG
IBM-1047	IBM-281	Yes	<prefix>EYEH
IBM-1047	IBM-282	Yes	<prefix>EYEI
IBM-1047	IBM-284	Yes	<prefix>EYEJ
IBM-1047	IBM-285	Yes	<prefix>EYEK
IBM-1047	IBM-290	Yes	<prefix>EYEL
IBM-1047	IBM-297	Yes	<prefix>EYEM
IBM-1047	IBM-500	Yes	<prefix>EYEO
IBM-1047	IBM-871	Yes	<prefix>EYER
IBM-1047	IBM-875	Yes	<prefix>EYES
IBM-1047	IBM-930	Yes	<prefix>EYEU
IBM-1047	IBM-939	Yes	<prefix>EYEV
IBM-1047	IBM-1026	Yes	<prefix>EYEW
IBM-1047	IBM-1027	Yes	<prefix>EYEX
IBM-1047	IBM-836	Yes	<prefix>EYGL
IBM-1047	IBM-833	Yes	<prefix>EYGP
IBM-1047	IBM-937	Yes	<prefix>EYGW
IBM-1047	IBM-935	Yes	<prefix>EYGY
IBM-1047	IBM-933	Yes	<prefix>EYGZ
IBM-1047	IBM-1140	Yes	<prefix>EYHA
IBM-1047	IBM-1141	Yes	<prefix>EYHB

Table 356. Coded character set conversion tables (continued)

FromCode	ToCode	GENXLT source shipped	Program Name
IBM-1047	IBM-1142	Yes	<prefix>EYHE
IBM-1047	IBM-1143	Yes	<prefix>EYHF
IBM-1047	IBM-1144	Yes	<prefix>EYHG
IBM-1047	IBM-1145	Yes	<prefix>EYHJ
IBM-1047	IBM-1146	Yes	<prefix>EYHK
IBM-1047	IBM-1147	Yes	<prefix>EYHM
IBM-1047	IBM-1148	Yes	<prefix>EYHO
IBM-1047	IBM-1149	Yes	<prefix>EYHR
IBM-1047	ISO8859-1	No	<prefix>EYI1
IBM-836	IBM-1047	Yes	<prefix>GLEY
IBM-833	IBM-1047	Yes	<prefix>GPEY
IBM-937	IBM-1047	Yes	<prefix>GWEY
IBM-935	IBM-1047	Yes	<prefix>GYEY
IBM-933	IBM-1047	Yes	<prefix>GZEY
IBM-933 (IBM-833 SBCS subset only)	IBM-819	No	<prefix>GZI1
IBM-1140	IBM-850	No	<prefix>HAAA
IBM-1140	IBM-500	Yes	<prefix>HAEO
IBM-1140	IBM-1047	Yes	<prefix>HAEY
IBM-1140	IBM-1148	Yes	<prefix>HAHO
IBM-1140	ISO8859-1	No	<prefix>HAI1
IBM-1141	IBM-850	No	<prefix>HBAA
IBM-1141	IBM-500	Yes	<prefix>HBEO
IBM-1141	IBM-1047	Yes	<prefix>HBEY
IBM-1141	IBM-1148	Yes	<prefix>HBHO
IBM-1141	ISO8859-1	No	<prefix>HBI1
IBM-1142	IBM-850	No	<prefix>HEAA
IBM-1142	IBM-500	Yes	<prefix>HEEO
IBM-1142	IBM-1047	Yes	<prefix>HEEY
IBM-1142	IBM-1148	Yes	<prefix>HEHO
IBM-1142	ISO8859-1	No	<prefix>HEI1
IBM-1143	IBM-850	No	<prefix>HFAA
IBM-1143	IBM-500	Yes	<prefix>HFEO
IBM-1143	IBM-1047	Yes	<prefix>HFEY
IBM-1143	IBM-1148	Yes	<prefix>HFHO
IBM-1143	ISO8859-1	No	<prefix>HFI1
IBM-1144	IBM-850	No	<prefix>HGAA
IBM-1144	IBM-500	Yes	<prefix>HGEO
IBM-1144	IBM-1047	Yes	<prefix>HGEY
IBM-1144	IBM-1148	Yes	<prefix>HGHO

Table 356. Coded character set conversion tables (continued)

FromCode	ToCode	GENXLT source shipped	Program Name
IBM-1144	ISO8859-1	No	<prefix>HGI1
IBM-1145	IBM-850	No	<prefix>HJAA
IBM-1145	IBM-500	Yes	<prefix>HJEO
IBM-1145	IBM-1047	Yes	<prefix>HJEY
IBM-1145	IBM-1148	Yes	<prefix>HJHO
IBM-1145	ISO8859-1	No	<prefix>HJI1
IBM-1146	IBM-850	No	<prefix>HKAA
IBM-1146	IBM-500	Yes	<prefix>HKEO
IBM-1146	IBM-1047	Yes	<prefix>HKEY
IBM-1146	IBM-1148	Yes	<prefix>HKHO
IBM-1146	ISO8859-1	No	<prefix>HKI1
IBM-1147	IBM-850	No	<prefix>HMAA
IBM-1147	IBM-500	Yes	<prefix>HMEO
IBM-1147	IBM-1047	Yes	<prefix>HMEY
IBM-1147	IBM-1148	Yes	<prefix>HMHO
IBM-1147	ISO8859-1	No	<prefix>HMI1
IBM-1148	IBM-850	No	<prefix>HOAA
IBM-1148	IBM-274	Yes	<prefix>HOEC
IBM-1148	IBM-275	Yes	<prefix>HOED
IBM-1148	IBM-281	Yes	<prefix>HOEH
IBM-1148	IBM-282	Yes	<prefix>HOEI
IBM-1148	IBM-290	Yes	<prefix>HOEL
IBM-1148	IBM-1027	Yes	<prefix>HOEX
IBM-1148	IBM-1047	Yes	<prefix>HOEY
IBM-1148	IBM-1140	Yes	<prefix>HOHA
IBM-1148	IBM-1141	Yes	<prefix>HOHB
IBM-1148	IBM-1142	Yes	<prefix>HOHE
IBM-1148	IBM-1143	Yes	<prefix>HOHF
IBM-1148	IBM-1144	Yes	<prefix>HOHG
IBM-1148	IBM-1145	Yes	<prefix>HOHJ
IBM-1148	IBM-1146	Yes	<prefix>HOHK
IBM-1148	IBM-1147	Yes	<prefix>HOHM
IBM-1148	IBM-1149	Yes	<prefix>HOHR
IBM-1148	ISO8859-1	No	<prefix>HOI1
IBM-1149	IBM-850	No	<prefix>HRAA
IBM-1149	IBM-500	Yes	<prefix>HREO
IBM-1149	IBM-1047	Yes	<prefix>HREY
IBM-1149	IBM-1148	Yes	<prefix>HRHO
IBM-1149	ISO8859-1	No	<prefix>HRI1
ISO8859-1	IBM-037	No	<prefix>I1EA

Table 356. Coded character set conversion tables (continued)

FromCode	ToCode	GENXLT source shipped	Program Name
ISO8859-1	IBM-273	No	<prefix>I1EB
ISO8859-1	IBM-274	No	<prefix>I1EC
ISO8859-1	IBM-275	No	<prefix>I1ED
ISO8859-1	IBM-277	No	<prefix>I1EE
ISO8859-1	IBM-278	No	<prefix>I1EF
ISO8859-1	IBM-280	No	<prefix>I1EG
ISO8859-1	IBM-281	No	<prefix>I1EH
ISO8859-1	IBM-282	No	<prefix>I1EI
ISO8859-1	IBM-284	No	<prefix>I1EJ
ISO8859-1	IBM-285	No	<prefix>I1EK
IBM-819	IBM-290	No	<prefix>I1EL
ISO8859-1	IBM-297	No	<prefix>I1EM
ISO8859-1	IBM-500	No	<prefix>I1EO
ISO8859-1	IBM-871	No	<prefix>I1ER
ISO8859-1	IBM-1027	No	<prefix>I1EX
ISO8859-1	IBM-1047	No	<prefix>I1EY
IBM-819	IBM-933	No	<prefix>I1GZ
ISO8859-1	IBM-1140	No	<prefix>I1HA
ISO8859-1	IBM-1140	No	<prefix>I1HB
ISO8859-1	IBM-1142	No	<prefix>I1HE
ISO8859-1	IBM-1143	No	<prefix>I1HF
ISO8859-1	IBM-1144	No	<prefix>I1HG
ISO8859-1	IBM-1145	No	<prefix>I1HJ
ISO8859-1	IBM-1146	No	<prefix>I1HK
ISO8859-1	IBM-1147	No	<prefix>I1HM
ISO8859-1	IBM-1148	No	<prefix>I1HO
ISO8859-1	IBM-1149	No	<prefix>I1HR
ISO8859-7	IBM-875	No	<prefix>I7ES
ISO8859-9	IBM-1026	No	<prefix>I9EW
IBM-943G	UCS-2	No	<prefix>ANU2
IBM-943G	UTF-8	No	<prefix>ANF8
UCS-2	IBM-943G	No	<prefix>U2AN
UTF-8	IBM-943G	No	<prefix>F8AN

## Universal coded character set converters

You can use the name UCS-2 to request setup for conversion to and from the Universal Two-Octet Coded Character Set, UCS-2, specified in ISO/IEC International Standard 10646-1. For example, `iconv_open("UCS-2", "IBM-1047")` requests setup for conversion from IBM-1047 character encoding to UCS-2 character encoding.

You can also use the name UTF-8 to request setup for conversion to and from Transform Format 8, UTF-8, specified in Unicode Standard, Version 2.1, Appendices A-7 and A-8. For example, `iconv_open("UTF-8", "IBM-1047")` requests setup for conversion from IBM-1047 character encoding to UTF-8 character encoding.

Before z/OS V1R12, source for UCS-2 converters was in a data set named `installation-prefix.SCEEUMAP`, where the installation prefix for z/OS XL C/C++ data sets defaults to CEE. UCS-2 source was also installed in the z/OS UNIX file system directory `/usr/lib/nls/locale/ucmap`. Starting in z/OS V1R12, IBM will no longer ship UCS-2 source with the C/C++ Runtime Library.

The `uconvdef` command, which is documented in *z/OS UNIX System Services Command Reference*, produces `uconvTable` binary files required by `iconv_open()` from UCS-2 source files.

The following notes apply only when you create your own converters:

- The `iconv()` family of functions uses Unicode Services to perform character conversion to or from UCS-2. Therefore, IBM no longer ships `uconvTable` binaries in either the `installation-prefix.SCEEUTBL` data set or the z/OS UNIX file system directory `/usr/lib/nls/locale/uconvTable`. Both the `installation-prefix.SCEEUTBL` data set and the `/usr/lib/nls/locale/uconvTable` directory have been removed. Users who create their own `uconvTable` converters need to create the `installation-prefix.SCEEUTBL` data set, the `/usr/lib/nls/locale/uconvTable` directory, or both to hold the converters. The `installation-prefix.SCEEUTBL` data set needs to be created with a fixed block record format and `lrecl` of 80.
- If your installation uses an installation-prefix different from CEE for z/OS XL C/C++ data sets, you must use the environment variable `_ICONV_UCS2_PREFIX` to specify the value of your installation-prefix before using `iconv_open()` to set up UCS-2 converters. Otherwise, `iconv_open()` cannot find your z/OS XL C/C++ `uconvTable` binary data set. One way to do this is to use the `ENVAR` runtime option when you start your application. For example, `ENVAR(..., _ICONV_UCS2_PREFIX=YOUR.PREFIX, ...)` has `iconv_open()` search for `uconvTable` binaries it requires in the data set `YOUR.PREFIX.SCEEUTBL`.
- If `uconvTable` binaries are installed in both the z/OS UNIX file system directory named `/usr/lib/nls/locale/uconvTable` and `installation-prefix.SCEEUTBL` data set, the `iconv_open()` function searches for `uconvTable` binaries in the z/OS UNIX file system before searching in the z/OS XL C/C++ UCS-2 data set.
- You can use the `LOCPATH` environment variable to give `iconv_open()` a colon-separated list of pathname prefixes to use instead of `/usr/lib/nls/locale/` to find `uconvTable` directories in your z/OS UNIX file system.
- If you have created your own conversion tables and want the `iconv()` family of functions to use them, you need to set the `_ICONV_MODE` environment variable to C.
- If you want to create customized conversion tables with any of the CCSIDs related to the conversion table source that is no longer shipped, create customized Unicode Services conversion tables instead of customized LE conversion tables. For information about how to generate and use customized Unicode Services conversion tables, see *z/OS Unicode Services User's Guide and Reference*.

You must set the `_ICONV_TECHNIQUE` environment variable to the same technique search order value used for the customized Unicode Services table in order for the `iconv()` family of functions to use the customized Unicode Services

table. For example, if you want the `iconv()` family of functions to use a user defined Unicode Services table with a technique search order of 2, you need to set the `_ICONV_TECHNIQUE` environment variable to `2LMREC`.

- The `uconvdef` and `genxlt` utilities continue to be shipped and maintained in z/OS V1R12. If you do not want to use Unicode Services to create customized conversion tables, you can continue to use the `uconvdef` and `genxlt` utilities. However, you must obtain the `ucmap` or `genxlt` source in one of the following ways:

- Migrate the `ucmap` or `genxlt` source forward from a previous z/OS release.
- Create the `ucmap` or `genxlt` source on your own.
- Get the `ucmap` or `genxlt` source from the IBM Character Data Representation Architecture Conversion resources:

[http://www-01.ibm.com/software/globalization/cdra/appendix\\_j.html](http://www-01.ibm.com/software/globalization/cdra/appendix_j.html)

The UCS-2 and `genxlt` conversion table binaries produced by the `uconvdef` and `genxlt` utilities continue to be supported by the `iconv()` family of functions if you set the `_ICONV_MODE` environment variable to `C`. You must obtain the conversion table binaries in one of the following ways:

- Migrate the conversion table binaries from a previous z/OS release.
- Create the conversion table binaries by your own.
- Create the conversion table binaries by the `uconvdef` or `genxlt` utilities.

**Note:** IBM makes no guarantee that the `uconvdef` or `genxlt` utilities will continue to be supported in future releases.

Members in the UCS-2 source data sets have names of the form `EDCUUccU`, where `cc` is the CC-id associated with a particular coded character set name. Table 357 shows the CC-id and member name associated with each coded character set name for which UCS-2 source is provided. The UCS-2 source is in a data set named `installation-prefix.SCEEUMAP`. The default value of the `installation-prefix` is `CEE`.

**CAUTION:**

**UCS-2 converter binaries added to the `SCEEUTBL` data set or the `uconvTable` directory must follow the `EDCUUccU` naming convention that allows `iconv` interfaces to recognize a UCS-2 converter.**

All UCS-2 tables are intended for the use with the C/C++ `iconv` interfaces or the `iconv` utility. Direct programming to these tables is not supported and will produce unpredictable results.

Starting in z/OS V1R12, IBM will not ship conversion table source in either the `installation-prefix.SCEEUMAP` data set or the `/usr/lib/nls/locale/ucmap` directory. However, if you choose to migrate the conversion tables to your own `installation-prefix.SCEEUTBL` data set, you need to continue to name them as listed in Table 357.

Table 357. UCS-2 converter names

Codeset Name	CC-id	Table name in a user-created <code>SCEEUTBL</code> data set
IBM-850	AA	<code>EDCUUAAU</code>
IBM-4946	AA	<code>EDCUUAAU</code>
IBM-301	AB	<code>EDCUUABU</code>
IBM-932	AB	<code>EDCUUABU</code>
IBM-942	AB	<code>EDCUUABU</code>



Table 357. UCS-2 converter names (continued)

Codeset Name	CC-id	Table name in a user-created SCEEUTBL data set
IBM-943G	AN	EDCUUANU
EUCJP	AC	EDCUUACU
IBM-EUCJP	AC	EDCUUACU
IBM33722	AC	EDCUUACU
IBM-922	AD	EDCUUADU
IBM-1046	AF	EDCUUAFU
IBM-932C	AG	EDCUUAGU
IBM-EUCJC	AH	EDCUUAHU
IBM-858	AI	EDCUUAIU
IBM-943	AJ	EDCUUAJU
IBM-859	AK	EDCUUAKU
IBM-425	AR	EDCUUARU
IBM-848	AS	EDCUUASU
IBM-1125	AT	EDCUUATU
IBM-1124	AU	EDCUUAUU
IBM-437	AV	EDCUUAVU
IBM-921	BD	EDCUUBDU
IBM-866	BE	EDCUUBEU
IBM-862	BH	EDCUUBHU
GBK	BS	EDCUUBSU
IBM-874	BU	EDCUUBUU
TIS-620	BU	EDCUUBUU
EUCTW-1993	BW	EDCUUBWU
IBM-EUCTW	BW	EDCUUBWU
IBM-964	BW	EDCUUBWU
IBM-1383	BY	EDCUUBYU
EUCKR	BZ	EDCUUBZU
IBM-EUCKR	BZ	EDCUUBZU
IBM-970	BZ	EDCUUBZU
IBM-861	CA	EDCUUCAU
IBM-852	CB	EDCUUCBU
IBM-855	CE	EDCUUCEU
IBM-864	CF	EDCUUCFU
IBM-869	CG	EDCUUCGU
IBM-856	CH	EDCUUCHU
IBM-1115	CL	EDCUUCLU
IBM-1380	CM	EDCUUCMU
IBM-904	CN	EDCUUCNU
IBM-927	CO	EDCUUCOU
IBM-1088	CP	EDCUUCPU

Table 357. UCS-2 converter names (continued)

Codeset Name	CC-id	Table name in a user-created SCEEUTBL data set
IBM-951	CQ	EDCUUCQU
IBM-942	CR	EDCUUCRU
IBM-1386	CV	EDCUUCVU
IBM-938	CW	EDCUUCWU
IBM-948	CW	EDCUUCWU
IBM-1381	CY	EDCUUCYU
IBM-949	CZ	EDCUUCZU
IBM-1252	DA	EDCUUDAU
IBM-1250	DB	EDCUUDBU
IBM-1251	DE	EDCUUDEU
IBM-1256	DF	EDCUUDFU
IBM-1253	DG	EDCUUDGU
IBM-1255	DH	EDCUUDHU
IBM-1254	DI	EDCUUDIU
IBM-5348	DJ	EDCUUDJU
IBM-5349	DK	EDCUUDKU
BIG5	DW	EDCUUDWU
IBM-947	DW	EDCUUDWU
IBM-950	DW	EDCUUDWU
IBM-928	DY	EDCUUDYU
IBM-936	DY	EDCUUDYU
IBM-946	DY	EDCUUDYU
IBM-037	EA	EDCUUEAU
IBM-28709	EA	EDCUUEAU
IBM-273	EB	EDCUUEBU
IBM-274	EC	EDCUUECU
IBM-275	ED	EDCUUEDU
IBM-277	EE	EDCUUEEU
IBM-278	EF	EDCUUEFU
IBM-280	EG	EDCUUEGU
IBM-281	EH	EDCUUEHU
IBM-282	EI	EDCUUEIU
IBM-284	EJ	EDCUUEJU
IBM-285	EK	EDCUUEKU
IBM-290	EL	EDCUUELU
IBM-297	EM	EDCUUEMU
IBM-300	EN	EDCUUENU
IBM-4396	EN	EDCUUENU
IBM-500	EO	EDCUUEOU
IBM-838	EP	EDCUUEPU

Table 357. UCS-2 converter names (continued)

Codeset Name	CC-id	Table name in a user-created SCEEUTBL data set
IBM-870	EQ	EDCUUEQU
IBM-871	ER	EDCUUERU
IBM-875	ES	EDCUUESU
IBM-880	ET	EDCUUETU
IBM-930	EU	EDCUUEEU
IBM-5026	EU	EDCUUEEU
IBM-939	EV	EDCUUEVU
IBM-5035	EV	EDCUUEVU
IBM-1026	EW	EDCUUEWU
IBM-1027	EX	EDCUUEXU
IBM-1047	EY	EDCUUEYU
IBM-924	EZ	EDCUUEZU
UTF-8	F8	EDCUUF8U
IBM-424	FB	EDCUUFBU
IBM-1122	FD	EDCUUFDU
IBM-1025	FE	EDCUUFEU
IBM-420	FF	EDCUUFFU
IBM-1165	FG	EDCUUFGU
IBM-1123	FH	EDCUUFHU
IBM-1158	FI	EDCUUFIU
IBM-4933	FJ	EDCUUFJU
IBM13124	Fk	EDCUUFKU
IBM-53668	FV	EDCUUFVU
IBM-1112	GD	EDCUUGDU
IBM-836	GL	EDCUUGLU
IBM-837	GM	EDCUUGMU
IBM-835	GO	EDCUUGOU
IBM-833	GP	EDCUUGPU
IBM-834	GQ	EDCUUGQU
IBM-1388	GV	EDCUUGVU
IBM-937	GW	EDCUUGWU
IBM-935	GY	EDCUUGYU
IBM-5031	GY	EDCUUGYU
IBM-933	GZ	EDCUUGZU
IBM-1140	HA	EDCUUHAU
IBM-1141	HB	EDCUUHBU
IBM16804	HC	EDCUUHCU
IBM-1157	HD	EDCUUHDU
IBM-1142	HE	EDCUUHEU
IBM-1143	HF	EDCUUHFU

Table 357. UCS-2 converter names (continued)

Codeset Name	CC-id	Table name in a user-created SCEEUTBL data set
IBM-1144	HG	EDCUUHGU
IBM12712	HH	EDCUUHHU
IBM-1145	HJ	EDCUUHJU
IBM-1146	HK	EDCUUHKU
IBM-1147	HM	EDCUUHMU
IBM-16684	HN	EDCUUHNU
IBM-1148	HO	EDCUUHOU
IBM-1160	HP	EDCUUHPU
IBM-1149	HR	EDCUUHRU
IBM-4971	HS	EDCUUHSU
IBM-1154	HT	EDCUUHTU
IBM-1390	HU	EDCUUHUU
IBM-1399	HV	EDCUUHVU
IBM-1155	HW	EDCUUHWU
IBM-5123	HX	EDCUUHXU
IBM-1156	HZ	EDCUUHZU
ISO8859-1	I1	EDCUUI1U
IBM-819	I1	EDCUUI1U
ISO8859-2	I2	EDCUUI2U
IBM-912	I2	EDCUUI2U
ISO8859-4	I4	EDCUUI4U
IBM-914	I4	EDCUUI4U
ISO8859-5	I5	EDCUUI5U
IBM-915	I5	EDCUUI5U
ISO8859-6	I6	EDCUUI6U
IBM-1089	I6	EDCUUI6U
ISO8859-7	I7	EDCUUI7U
IBM-813	I7	EDCUUI7U
ISO8859-8	I8	EDCUUI8U
IBM-916	I8	EDCUUI8U
ISO8859-9	I9	EDCUUI9U
IBM-920	I9	EDCUUI9U
IBM-4909	IA	EDCUUIAU
IBM-923	IF	EDCUUIFU
ISO8859-15	IF	EDCUUIFU
ISO-2022-JP	JA	EDCUUJAU
IBM-956	JB	EDCUUJBU
IBM-957	JC	EDCUUJCU
IBM-956C	JD	EDCUUJDU
IBM-958	JD	EDCUUJDU

Table 357. UCS-2 converter names (continued)

Codeset Name	CC-id	Table name in a user-created SCEEUTBL data set
IBM-957C	JE	EDCUUJEU
IBM-959	JE	EDCUUJEU
IBM-5052	JF	EDCUUJFU
IBM-5053	JG	EDCUUJGU
IBM-5052C	JH	EDCUUJHU
IBM-5054	JH	EDCUUJHU
IBM-5053C	JI	EDCUUJIU
IBM-5055	JI	EDCUUJIU
IBM-1371	KA	EDCUUKAU
IBM-1364	KZ	EDCUUKZU
IBM-1370	LA	EDCUULAU
IBM-902	LD	EDCUULDU
IBM-872	LE	EDCUULEU
IBM-808	LF	EDCUULFU
IBM-9061	LG	EDCUULGU
IBM-901	LH	EDCUULHU
IBM-9238	LI	EDCUULIU
IBM-867	LJ	EDCUULJU
IBM-1161	LU	EDCUULUU
IBM-1363	LZ	EDCUULZU
IBM-1153	MB	EDCUUMBU
IBM-5346	NB	EDCUUNBU
IBM-5347	NE	EDCUUNEU
IBM-5352	NF	EDCUUNFU
IBM-9044	NG	EDCUUNGU
IBM-5351	NH	EDCUUNHU
IBM-5350	NI	EDCUUNIU
IBM17248	NJ	EDCUUNJU
UCS-2	U2	EDCUUU2U

## Codeset conversion using UCS-2

z/OS XL C/C++ iconv supports use of UCS-2 as an intermediate code set for conversion of characters encoded in one code set to another. The `_ICONV_UCS2` environment variable instructs `iconv_open("Y", "X")` whether or not to set up indirect conversion from code set X to code set Y using UCS-2 as an intermediate code set. Values `iconv_open()` recognizes for `_ICONV_UCS2` are:

- 1 Set up indirect conversion using UCS-2 first. The indirect conversions will use direct unicode converters if available, if not, `iconv_open()` will `fopen/fread` `uconvTable` binaries. If set up of indirect conversion fails, `iconv_open()` will try to set up direct conversion.
- 2 Set up direct conversion first. If this fails, try to set up indirect conversion

using UCS-2. The indirect conversions will use direct unicode converters if available, if not, `iconv_open()` will fopen/fread `uconvTable` binaries. This is the default.

- 3 Set up direct conversion first. If this fails, try to set up indirect conversion using UCS-2. The indirect conversions will use direct unicode converters, if direct unicode converters are unavailable, the `iconv_open()` request fails.
- N Never set up indirect conversion using UCS-2. If a direct converter cannot be found, the `iconv_open()` request fails.
- D Never set up indirect conversion using UCS-2. If a direct converter cannot be found, the `iconv_open()` request fails.
- O Only set up indirect conversion using UCS-2. `iconv_open()` will fopen/fread `uconvTable` binaries. Direct unicode converters will **not** be used. If required `uconvTable` binaries cannot be found, the `iconv_open()` request fails..
- U Only set up indirect conversion using UCS-2. The indirect conversions will use direct unicode converters if available, if not, `iconv_open()` will fopen/fread `uconvTable` binaries.

**Notes:**

1. `_ICONV_UCS2` environment variable only has effect when `ICONV_MODE` is set to C.
2. If the value of the `_ICONV_UCS2` environment variable allows `iconv_open("Y", "X")` to use UCS-2 as an intermediate code set when it cannot find a direct converter from X to Y, `iconv_open()` will attempt to do so even if X and Y are not compatible code sets. That is, even if character sets encoded by X and Y are not the same, `iconv_open()` will set up conversion from X to UCS-2 to Y.
3. The application must specify compatible source and target code set names on various `iconv_open()` requests. For detailed information about code set characteristics, refer to the specific coded character set identifier in the CCSID repository. For more information, refer to the following URL:  
[http://www-01.ibm.com/software/globalization/ccsid/ccsid\\_registered.html](http://www-01.ibm.com/software/globalization/ccsid/ccsid_registered.html)

## UCMAP source format

A UCMAP source file defines UCS-2 (Unicode) conversion mappings for input to the `uconvdef` command. Conversion mapping values are defined using UCS-2 symbolic character names followed by character encoding (code point) values for the multibyte code set. For example:

`<U0020>`

`\x20` represents the mapping between the `<U0020>` UCS-2 symbolic character name for the space character and the `\x20` hexadecimal code point for the space character in ASCII.

In addition to the code set mappings, directives are interpreted by the `uconvdef` command to produce the compiled table. These directives must precede the code set mapping section. They consist of the following keywords surrounded by `<>` (angle brackets), starting in column 1, followed by white space and the value to be assigned to the symbol:

`<comment_char>`

Character used to denote start of escape sequence. Default escape character is `<number_sign>` (`#`). In `ucmap`, source shipped by C/370 `<percent_sign>` (`%`) is specified for `<comment_char>`.

**<escape\_char>**

Character used to denote start of escape sequence. Default escape character is <backslash> (\). In ucmmap source shipped by C/370 <slash> (/) is specified for <escape\_char>.

**<code\_set\_name>**

The name of the coded character set, enclosed in quotation marks(""), for which the character set description file is defined.

**<mb\_cur\_max>**

The maximum number of bytes in a multibyte character. The default value is 1.

**<mb\_cur\_min>**

An unsigned positive integer value that defines the minimum number of bytes in a character for the encoded character set. The value is less than or equal to <mb\_cur\_max>. If not specified, the minimum number is equal to <mb\_cur\_max>.

**<char\_name\_mask>**

A quoted string consisting of format specifiers for the UCS-2 symbolic names. This must be a value of AXXXX, indicating an alphabetic character followed by 4 hexadecimal digits. Also, the alphabetic character must be a U, and the hexadecimal digits must represent the UCS-2 code point for the character. An example of a symbolic character name based on this mask is <U0020> Unicode space character.

**<uconv\_class>**

Specifies the type of the code set. It must be one of the following:

**SBCS** Single-byte encoding

**DBCS** Stateless double-byte, single-byte, or mixed encodings

**EBCDIC\_STATEFUL**

Stateful double-byte, single-byte, or mixed encodings

**MBCS** Stateless multibyte encoding

This type is used to direct uconvdef on the type of table to build. It is also stored in the table to indicate the type of processing algorithm in the UCS conversion methods.

**<locale>**

Specifies the default locale name to be used if locale information is needed.

**<subchar>**

Specifies the encoding of the default substitute character in the multibyte code set.

The mapping definition section consists of a sequence of mapping definition lines preceded by a CHARMAP declaration and terminated by an END CHARMAP declaration. Empty lines and lines containing <comment\_char> in the first column are ignored.

Symbolic character names in mapping lines must follow the pattern specified in the <char\_name\_mask>, except for the reserved symbolic name, <unassigned>, that indicates the associated code points are unassigned.

Each noncomment line of the character set mapping definition must be in one of the following formats:

1. This format defines a single symbolic character name and a corresponding encoding.

"%s%s/n", <symbolic\_name>, <encoding>, <comments>

For example: <U3004> \x81\x57

The encoding part is expressed as one or more concatenated decimal, hexadecimal, or octal constants in the following formats:

- "%cd%d", <escape\_char>, <decimal byte value>
- "%cX%X", <escape\_char>, <hexadecimal byte value>
- "%c%o", <escape\_char>, <octal byte value>

Decimal constants are represented by two or more decimal digits preceded by the escape character and the lowercase letter d, as in \d97 or \d143.

Hexadecimal constants are represented by two or more hexadecimal digits preceded by an escape character and the lowercase letter x, as in \x61 or \x8f.

Octal constants are represented by two or more octal digits preceded by an escape character.

Each constant represents a single—byte value. When constants are concatenated for multibyte character values, the last value specifies the least significant octet and preceding constants specify successively more significant octets.

2. This format defines a range of symbolic character names and corresponding encodings. The range is interpreted as a series of symbolic names formed from the alphabetic prefix and all the values in the range defined by the numeric suffixes.

"%s...%s %s %s/n", <symbolic-name>, <symbolic\_name>, <encoding><comments>

For example: <U3003><U3006> \x81\x56

The listed encoding value is assigned to the first symbolic name, and subsequent symbolic names in the range are assigned corresponding incremental values. For example, the line:

<U3003>...<U3006> \x81\x56

is interpreted as:

```
<U3003> \x81\x56
<U3004> \x81\x57
<U3005> \x81\x58
<U3006> \x81\x59
```

3. This format defines a range of one or more unassigned encodings.

"<unassigned>%s...%s %s/n", <encoding>, <comments>

For example, the line

<unassigned> \x9b... \x9c

is interpreted as:

```
<unassigned> \x9b <unassigned> \x9c
```





---

## Chapter 65. Coded character set considerations with locale functions

Each EBCDIC *coded character set* consists of a mapping of all the available glyphs to their respective hex encodings and unique Graphic Character Global Identifiers (GCGIDs). GCGIDs are unique identifiers assigned to each character in the Unicode standard. A *glyph* is the printed appearance of a character. Each coded character set serves one linguistic environment.

There is wide variation among coded character sets; many glyphs do not appear in all coded character sets, and hexadecimal encodings for some glyphs differ from one coded character set to another. You may encounter problems when exporting a file from a system running in one coded character set, to a system running in another. For example, a left bracket (I) entered under the APL-293 or Open Systems IBM-1047 coded character set will appear as the capitalized Y-acute (Y). This occurs in such common coded character sets as International 500, France 297, Germany 273, and US or Canada 037.

z/OS XL C/C++ contains the following extensions to prevent such problems:

- The `#pragma filetag` directive allows you to specify the coded character set that was used when entering the source files. See “The pragma filetag directive” on page 1053 for details on this pragma.
- The `LOCALE` compiler option enables you to tell the compiler what locale to use at compile time. See “Converting coded character sets at compile time” on page 1056 for details on this compiler option.
- The `CONVLIT` compiler option enables you to change the assumed code page for string literals. See “CONVLIT compiler option” on page 1056 for details on this compiler option.
- The `#pragma convert` directive allows you to change the assumed code page for string literals. It has the advantage of allowing more than one character encoding to be used for string literals in a single compilation unit. For more information, see `convert` in *z/OS XL C/C++ Language Reference*.

These facilities cause the compiler to respect your code page. Thus, you can enter source code with what appears to you to be the correct characters, and the compiler will recognize those characters.

The rest of this chapter discusses other ways to work efficiently in different locales.

---

### Variant character detail

The POSIX Portable Character Set (PPCS) identifies the core set of 128 characters that are needed to write code and to run applications. Of these, 13 characters are variant among the EBCDIC coded character sets.

Table 358 on page 1048 lists these 13 characters. It also displays their appearance when the Open Systems coded character set IBM-1047 hexadecimal values are entered on systems where different Country Extended Coded Character Sets are installed. These hex values are the ones expected by z/OS XL C/C++, and are consistent with the use of the APL-293 coded character set.

Table 358. Mappings of 13 PPCS variant characters

Character	Open Systems Hex Value (Default)	Open Systems IBM-1047 view	APL IBM-293 view	International IBM-500 view	France IBM-297 view	Germany IBM-273 view	US/Can IBM-037 view
left bracket	AD	[	[	Ý	Ý	Ý	Ý
right bracket	BD	]	]	ü	~	ü	"
left brace	C0	{	{	{	é	ä	{
right brace	D0	}	}	}	è	ü	}
backslash	E0	\	\	\	ç	Ö	\
circumflex	5F	^	ˆ	^	^	^	ˆ
tilde	A1	~	˜	~	ü .	ß	~
exclamation mark	5A	!	!	]	§	Û	!
pound (number) sign	7B	#	#	#	£	#	#
vertical bar	4F			!	!	!	
accent grave	79	`	˘	˘	µ	˘	˘
dollar sign	5B	\$	\$	\$	\$	\$	\$
commercial "at"	7C	@	@	@	á	§	@

Table 359 lists the hexadecimal values assigned across some of the EBCDIC coded character sets for the 13 variant characters from the PPCS. Appendix C, "z/OS XL C/C++ code point mappings," on page 1089 gives more information about the mapping of glyphs and Appendix A, "POSIX character set," on page 1079 lists the full PPCS.

Table 359. Mappings of Hex encoding of 13 PPCS variant characters

Character Name	Glyph	GCGID	Open Systems IBM-1047 view	APL IBM-293 view	International 500 view	France 297 view	Germany 273 view	US/Can 037 view
left bracket	[	SM060000	AD	AD	4A	90	63	BA
right bracket	]	SM080000	BD	BD	5A	B5	FC	BB
left brace	{	SM110000	C0	C0	C0	51	43	C0
right brace	}	SM140000	D0	D0	D0	54	DC	D0
backslash	\	SM070000	E0	E0	E0	48	EC	E0
circumflex	^	SD150000	5F	5F	5F	5F	5F	B0
tilde	~	SD190000	A1	A1	A1	BD	59	A1
exclamation mark	!	SP020000	5A	5A	4F	4F	4F	5A
pound (number) sign	#	SM010000	7B	7B	7B	B1	7B	7B
vertical bar		SM130000	4F	4F	BB	BB	BB	4F
accent grave	`	SD130000	79	79	79	A0	79	79
dollar sign	\$	SC030000	5B	5B	5B	5B	5B	5B
commercial "at"	@	SM050000	7C	7C	7C	44	B5	7C

Two tables are available to show the full code—point mappings for Open Systems coded character set IBM-1047 (Figure 274 on page 1089) and for the APL coded character set IBM-293 (Figure 275 on page 1090). Upon examination of these coded character sets, you will notice that coded character set 1047 is a "Latinized" coded character set IBM-293. All the APL code points have been replaced by Latin 1 code points, allowing a one-to-one mapping among coded character set IBM-1047 and all other coded character sets in the Latin 1 group.

Although the official current coded character set for z/OS XL C/C++ is now coded character set IBM-1047 (Open Systems), the coded character set IBM-293 *syntax* points are still valid. Those points are the ones with syntactic relevance to the z/OS XL C/C++ compiler. Refer to Table 358 on page 1048 and Table 359 on page 1048 for more information.

---

## Alternate code points

All syntactic code points that were supported in previous versions of z/OS XL C/C++ will continue to be supported *if* you are compiling with the NOLOCALE option.

To be compatible, the vertical bar character is represented by the following two encodings, provided you are not using the LOCALE compiler option or the NOLOCALE option:

- X'4F'
- X'6A'

If you do specify the LOCALE compiler option, each of these characters is represented by a unique value specified in the LC\_SYNTAX category of the selected locale.

---

## Coding without locale support by using a hybrid coded character set

If you want to avoid using the locale of the compiler, use a hybrid coded character set. A *hybrid* piece of code is in the local coded character set but the syntax is written *as if* it were in coded character set IBM-1047.

You can continue coding in the local coded character set, writing the syntax *as if* it were in coded character set IBM-1047. This solution uses the existing behavior of the compiler, but this method is not ideal for the following reasons; Figure 261 on page 1050 illustrates these difficulties.

- The code can be difficult to read and may not even look like C code anymore.
- There may be ambiguities in the code.
- Exporting code to another site can be difficult because the mapping between the hybrid characters used and the target coded character set may not be exact.

---

```

/* this has strings in codepage 273 with APL 293 syntax, and is a */
/* pre-locale source file for a user in Germany */
&hash273;define MAX_NAMES      20
&hash273;define MAX_NAME_LEN   80
&hash273;define STR(num)      &hash273;num
&hash273;define SCAN_FORMAT(len) "%STR(len)"s "%STR(len)"s"

struct NameList &obrc273;
  char first&obrc273;MAX_NAME_LEN+1&cbrk273;;
  char surname&obrc273;MAX_NAME_LEN+1&cbrk273;;
&cbrc273;;
int compareNames(const void *elem1, const void *elem2) &obrc273;
  struct NameList *name1 = (struct NameList *) elem1;
  struct NameList *name2 = (struct NameList *) elem2;
  int surnameComp = strcoll(name1&ptr273;surname,
                           name2&ptr273;surname);
  int firstComp  = strcoll(name1&ptr273;first,
                          name2&ptr273;first);

  return(surnameComp ? surnameComp : firstComp);
&cbrc273;;

main() &obrc273;
  int i, rc, numEntries;
  struct NameList curName;
  struct NameList nameList&obrc273;MAX_NAMES&cbrk273;;
  printf("Bitte geben Sie die Namen ein, "
        "im Format &lt;Famliename> &lt;Voname> "
        "(Maximum %d Namen!)&esc273;",
        MAX_NAMES);
  for (i=0; i&lt;MAXNAMES; &pp273;i &obrc273;
    printf("Name (oder EOF wenn fertig)&esc273;");
    rc = scanf(SCAN_FORMAT(MAX_NAME_LEN),
              curName.surname, curName.first);
    if (rc &lneq273 2) &obrc273
      break;
    &cbrc273;;
    nameList&obrc273;i&cbrk273 = curName;
&cbrc273;;
  numEntries = i+1;
  qsort(nameList, numEntries, sizeof(struct NameList),
        compareNames);
  for (i=0; i&lt;numEntries; &pp273;i &obrc273;
    printf("Name %d:&lt;%s, s>&esc273;", i+1,
          nameList&obrc273;i&cbrk273;.surname,
          nameList&obrc273;i&cbrk273;.first);
    ü
  i != (MAX_NAMES << sizeof(int)/2);
  return(i);ü

```

---

Figure 261. Example of hybrid coded character set

The code points in Figure 261, which have different glyphs in character code set IBM-273 and APL-293, are described below:

- 1** code point for the { character. In coded character set 273, this is the character ä.
- 2** code point for the [ character. In coded character set 273, this is the character Ÿ.
- 3** code point for the ] character. In coded character set 273, this is the character ”.
- 4** code point for the } character. In coded character set 273, this is the character ü.

- 5** code point for the \ character. In coded character set 273, this is the character Ö.
- 6** code point for the ! character. In coded character set 273, this is the character Ü.
- 7** code point for the | character. In coded character set 273, this is the character !. This particular code point mapping is unfortunate because the | character and the ! character are both valid C syntax characters. Note that the ! character used in the printf() call at **8** will appear as ! on a terminal displaying in coded character set 273.

## Writing code using a hybrid coded character set

Figure 261 on page 1050 illustrates some of the problems with hybrid files. The following steps were done when writing this code:

1. Look up each variant character in coded character set IBM-1047 to find out what the compiler expects. For example, z/OS XL C/C++ expects the character [ to have a byte value of X'AD'.
2. Determine which glyph is at X'AD' in the local coded character set, then use this in the code.
3. Always use the appropriate substitution. For example, to obtain a needed [ in Germany, one would look up X'AD' in the German IBM-273 coded character set, and find the character Ÿ.

## Converting hybrid code

Existing code that was written in a hybrid coded character set will continue to be supported. Appendix G, "Converting hybrid code to a specific character set," on page 1133 shows you a program you can use to convert the hybrid code to another coded character set.

---

## Coded character set independence in developing applications

You can ensure that you are working effectively with the locale functionality if you use the appropriate functions, macros, and tools. Figure 262 on page 1052 is a summary of the compile-edit work flow and shows which functions to use and where you can use them.

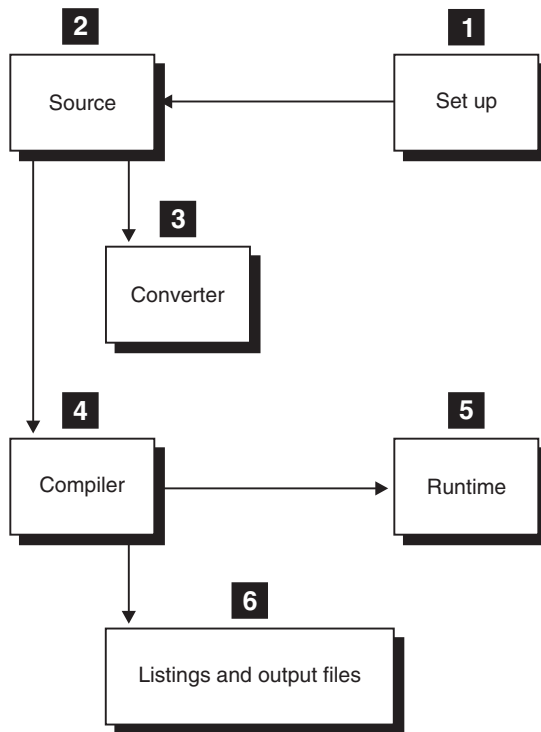

Figure 262. Compile-edit, related to locale function

- 1** **Setup.** The localedef information (see overview in Chapter 61, “Customizing a locale,” on page 1005 and details in “Locale source files” on page 964).
- 2** **Coded character set of source code, header files, and data.** The compiler must support the coded character set used to create a source file so that it will recognize the variant C syntax characters correctly.
  - The `#pragma filetag` directive identifies the coded character set of the source file as well as the library or user's *include* files (for an overview see “The pragma filetag directive” on page 1053)
  - Predefined macros `__LOCALE__`, `__FILETAG__`, and `__CODESET__` (for an overview see “Using predefined macros” on page 1054)
  - The function `setlocale()`
  - The pragma `convlit` directive
  - The pragma `convert` directive
- 3** **Coded character set conversion utilities and functions.** The coded character set of a file, or a stream of data, can be converted to another coded character set using the utilities `genxlt` and `iconv` (for an overview see Chapter 64, “Code set conversion utilities,” on page 1023; for the details of the utilities and functions, see *z/OS XL C/C++ User's Guide*), as well as the functions in the runtime library.
- 4** **Coded character set conversion at compile time** is determined by the compile-time locale and supported by the compiler options, `LOCALE` and `NOLOCALE` (for an overview, see “Converting coded character sets at compile time” on page 1056; for details, see `LOCALE` in *z/OS XL C/C++ User's Guide*).

- 5 Runtime environment.** During run time, the `setlocale()` function has an effect on runtime functions, such as `printf()`, `scanf()`, and `regcomp()`, which use variant characters.
- 6 Listings and output files.** The coded character set used to create or to convert source files may affect listings, preprocessed source code, object modules, and SYSEVENT files (for an overview see “Object modules and output listings” on page 1058). Your application can, however, include logic using the following to minimize the impact:
  - `__LOCALE__`, `__FILETAG__`, and `__CODESET__` macros
  - Locale functions such as `setlocale()`

## Coded character set in source code and header files

There are five types of locale-related changes that you can make in your source code:

- You can tag your source code and other associated files with the `#pragma filetag` directive to specify the coded character set that was used while entering the file. You can then compile these to ensure that all variant characters in your files are correct.
- You can use the three macros: `__LOCALE__`, `__FILETAG__`, and `__CODESET__`. These z/OS XL C/C++ macros expand to provide information about the `#pragma filetag` directive of the current source, and the locale and target coded character set used by the compiler at compile time. For more information, see predefined macros for ISO Standard and z/OS XL C/C++ in *z/OS XL C/C++ Language Reference*.
- You can use the `setlocale()` function to set the runtime locale to be the same as the locale used to compile the application. This can be used when your application contains dependencies on the coded character set, as it would when comparing constants with external data. Using the macros forces the runtime locale to be the same as the one used to compile your code.
- You can use the `#pragma convlit suspend` and `resume` to exclude portions of your code from string literal conversion. See `CONVLIT` in *z/OS XL C/C++ User's Guide* for more details on the compiler option and `convlit` in *z/OS XL C/C++ Language Reference* for more information on the pragma.
- You can use the `#pragma convert` directive to specify the coded character set to use for converting string literals. See `convert` in *z/OS XL C/C++ Language Reference* for more information on this pragma.

### The pragma filetag directive

By using the `#pragma filetag` directive, you may write your programs in any convenient supported coded character set (see Appendix D, “Locales supplied with z/OS XL C/C++,” on page 1091 for a list of coded character set names). The `#pragma filetag` directive instructs the z/OS XL C/C++ compiler how to “read” the source. *Tagging* the source files, the header files, and all data files (including messages) with the `#pragma filetag` directive enables you to keep the information about the coded character set used to create each source file, within the source file itself. This information can be helpful when moving source files to systems with different coded character sets. For more information, see `filetag` in *z/OS XL C/C++ Language Reference*.

The following example tag uses the German coded character set IBM-273:

```
??=pragma filetag("IBM-273")
```



Because the # character is variant in different coded character sets, you must use the trigraph `??=` for the `#pragma filetag` directive.

The `#pragma filetag` directive specifies the coded character set in which the source or data was entered. The coded character set specified in the `#pragma filetag` directive is in effect for the entire source file, but not for any other source file. This also applies to header files and data files.

The `#pragma filetag` directive can only appear once in each file, and it must appear before the first statement in a program. If encountered elsewhere, a warning appears and the directive does not change. If a comment contains variant characters and appears before the directive, the comment does not translate.

**Attention:** If you wish to use the `iconv` utility on a file that is tagged with the `??= #pragma filetag` directive, you must update the file manually to change the filetag to the correct converted coded character set. `iconv` does not update the pragma in source files.

## Using predefined macros

There are three macros for z/OS XL C/C++ that relate to locale.

### `__LOCALE__`

This macro expands to a string literal representing the locale of the `LOCALE` compiler option. This macro can be used to set the runtime locale to be the same as the compiled locale:

```
main() {
    setlocale(LC_ALL, __LOCALE__);

    :
}
```

The value of this macro is defined per compilation. If `NOLOCALE` compiler option is supplied, the macro is undefined.

### `__FILETAG__`

This macro expands to a string literal representing the character coded character set of the `#pragma filetag` directive associated with the current file. For example, to convert to the coded character set specified by the `LOCALE` option from the coded character set specified by the `#pragma filetag` directive, you would use the `iconv_open()` function:

```
iconv_open(__FILETAG__,variable);
```

The value of this macro is defined per source file. If no `#pragma filetag` directive is present, the macro is undefined.

### `__CODESET__`

This macro expands to a string literal representing the character coded character set of the `LOCALE` compiler option. The value of this macro is defined per compilation. If a value is not supplied, the macro is undefined.

Figure 263 on page 1055 shows an example program (`CCNGCC2`) that uses the `__CODESET__` macro.

---

```

#include <iconv.h>
#include <string.h>
#include <stdio.h>

/* The following function could be in a header file */
#ifdef __CODESET__
    static int convstr(iconv_t convInfo, char *in, int inSize,
                      char *out, int outSize) {
        return(iconv(convInfo, in, inSize, out, outSize))
    }
#else
    static int convstr(iconv_t convInfo, char *in, int inSize,
                      char *out, int outSize) {
        memcpy(out, in, outSize > inSize ? inSize :
              outSize);
        return(outSize > inSize ? -1 ::
              0);
    }
#endif

iconv_t convInfo;

int main() {
#ifdef __CODESET__
    char *run-timeCodeSet;
    setlocale(LC_ALL, ""); /* set locale to default locale */
    run-timeCodeSet = nl_langinfo(CODESET);
    convInfo = iconv_open(run-timeCodeSet, __CODESET__);
#endif
    char intro[] = "Welcome to my variant world!\n";
    char nlIntro[sizeof(intro)];
    convstr(convInfo, intro, sizeof(intro),
            nlIntro, sizeof(nlIntro));
    puts(nlIntro); /* string will print appropriately */
#ifdef __CODESET__
    iconv_close(convInfo);
#endif

    return(0);
}

```

---

Figure 263. Example of `__CODESET__` macro

Figure 264 on page 1056 shows the values that these macros will take on, emphasizing that for `__FILETAG__`, a value is assigned for each source file, but for `__LOCALE__` and `__CODESET__`, a value is assigned for a compilation.

Assuming: Compiled source file with LOCALE("De\_DE.IBM-273")

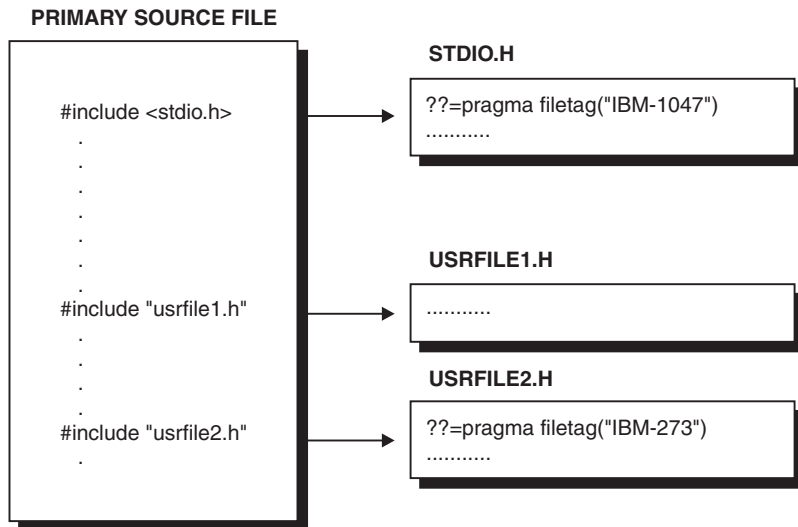

For the entire compilation: `__LOCALE__ = "De_DE.IBM273"`  
`__CODESET__ = "IBM-273"`

In STDIO.H: `__FILETAG__ = "IBM-1047"`

In USRFILE1.H: `__FILETAG__` is undefined

In USRFILE2.H: `__FILETAG__ = "IBM-273"`

Figure 264. Values of macros `__FILETAG__`, `__LOCALE__`, and `__CODESET__`

### Using `setlocale()`

You can change the runtime locale to any one of the other predefined locales listed in Table 362 on page 1092. To use a defined locale, refer to it by its `setlocale()` parameter. To define a new locale, copy the source file provided, edit it, then assemble it (see Chapter 61, "Customizing a locale," on page 1005).

## Converting coded character sets at compile time

The following section describe compiler options you can use to covert coded character sets.

### CONVLIT compiler option

You can control the conversion of string literals in your code by using the CONVLIT compiler option. CONVLIT provides a means for changing the assumed code page for character string literals by supplying a codepage value. For more information, see CONVLIT in *z/OS XL C/C++ User's Guide*.

For example, if you used an ASCII client machine to write code that uses string literals, and then upload this to an EBCDIC server such as MVS, your string literals would be converted to EBCDIC. However, if you specified `"CONVLIT(IS08859-1)"` when you compiled your code, your string literals would have been converted to an ASCII code page.

For example, consider the program in Figure 265. When this program is compiled with the CONVLIT (ISO8859-1) option, the string "Hi There!" will be converted to an ASCII string, but the string "Hello World" will not be converted.

---

```
/* header.h */
char *text="Hello World";

/* test.c */
#pragma convlit(suspend)
#pragma comment (user, "A user comment")

#include <stdio.h>
#include "header.h"
#pragma convlit(resume)

main (){
    char *text2 ="Hi There!";
}
```

---

Figure 265. Using the CONVLIT compiler option

### LOCALE compiler option

The LOCALE compiler option enables you to instruct the compiler to use a specific locale at compile time, which then generates the output in the same coded character set.

The input files that are affected are:

- The primary source file
- Library header files
- User header files

The output files that are affected are:

- Object Modules
- Preprocessed source code
- Listings

To use the LOCALE option, you must supply a locale name value. The locale name is a string that represents the locale you want to compile source with; this will determine the characteristics of output, including the coded character set used for variant characters in the source. Usually, a locale name is of the format *territory name.coded character set*. For example, the German locale for coded character set 273 is De\_DE.IBM-273. The *territory name* is De\_DE and the *coded character set* is IBM-273. To determine the coded character set of the current locale, use the function `nl_langinfo(CODESET)`.

The special locale name "" gives you the default locale, which can be set using environment variables. The locale name "C" specifies the C default locale. Full details about the C locale are found in Chapter 63, "Definition of S370 C, SAA C, and POSIX C locales," on page 1015.

The default option setting is NOLOCALE. It instructs the compiler to do no conversion of text for input or for output.

You can create your own locales by using the `localedef` utility. See "Locale source files" on page 964 for details.

**Examples:** To compile a sample file, `userid.SORTNAME.C`, enter:

```
CC 'userid.SORTNAME.C' (LOCALE("De_DE.IBM-273"))
```

The compiler recognizes "De\_DE.IBM-273" as a valid locale and automatically converts the source code to coded character set IBM-273, for its own use. The compiler would then generate listings in the German coded character set 273.

To generate a preprocessed file that can be sent to other sites, that use different coded character sets, enter:

```
CC 'userid.SORTNAME.C' (LOCALE("De_DE.IBM-273")) PPNLY
```

The compiler will insert the `#pragma filetag` directive at the start of the preprocessed file, using the coded character set specified in the `LOCALE` option. In this example, `??=pragma filetag("IBM-273")` is inserted.

Since the preprocessed file has been tagged, it can be compiled using the z/OS XL C/C++ compiler at any site, regardless of the locale used.

**Summary of usage for `LOCALE`, `NOLOCALE`, and `pragma filetag` directive:** The following list shows the results from different combinations of the `#pragma filetag` directive and the `LOCALE` compiler option.

#### Using `LOCALE` compiler option

In this case, the compiler does the following:

- Converts the source code from the coded character set specified with the `#pragma filetag` directive to the code set specified by the `LOCALE` compiler option.
- If no `#pragma filetag` directive is specified, the compiler assumes the source is in the same coded character set as specified by the locale, and does not perform any conversion.
- Converts compiler error messages from coded character set IBM-1047 to the coded character set specified in the `LOCALE` compiler option.
- Generates compiler output in the same coded character set as that of the locale specified in the `LOCALE` compiler option.
- If `PPONLY` was specified, the compiler inserts the `#pragma filetag` directive at the beginning of the preprocessor file, using the coded character set specified in the locale option.

#### Using `NOLOCALE` compiler option

In this case, the compiler does the following:

- Does not convert text in the input or output file, and uses the default coded character set IBM-1047 to interpret syntactic characters.
- If a `#pragma filetag` directive is specified, the compiler suppresses the `#pragma filetag` directive in the preprocessor file. The compiler issues warnings if the `#pragma filetag` directive specifies a coded character set other than IBM-1047, and uses IBM-1047 anyway.

**Object modules and output listings:** The compiler respects the locale specified by the `LOCALE` compiler option when it generates the listing.

If the `locale` option is specified, the object module is generated in the coded character set of your current locale. Otherwise, the object module is generated in the coded character set IBM-1047.

Code will run correctly if the runtime locale is the same as the locale of the object module.

If the object was generated with a different locale from the one you run under, you must ensure that your code can run under different locales. Refer to Chapter 61, “Customizing a locale,” on page 1005 for more information.

For information about exporting code to other sites, see “Exporting source code to other sites” on page 1062.

You can use the `LOCALE` compiler option to ensure that listings are sensitive to a specified locale.

Figure 266 on page 1060 shows the result from compiling source file `hello273.c` with:

```
xlc -F:c89 -o hello273 -qso -qlocale="De_DE.IBM-273" -qxplink -qgoff hello273.c
```

In Figure 266 on page 1060, notice the locale-specific information:

- 1** The date at the top right. The format of the date in the listing is that specified by the locale.
- 2** The name of the locale and the code set.
- 3** Code points for the `}`, `/`, and `{` characters.

\*\*\*\*\* P R O L O G \*\*\*\*\*

Compile Time Library . . . . . : 42020000

Command options:

Program name . . . . . : ./hello273.c

```

Compiler options
: *NOGONUMBER *NOALIAS *NORENT *TERMINAL *NOUPCONV *SOURCE *LIST
: *XREF *AGG *NOPPONLY *NOEXPMAC *NOSHOWINC *NOOFFSET *MEMORY *NOSSCOMM
: *NOSHOWMACROS *SKIPSRC (SHOW) *NOREPORT *NOMAKEDEP *PREFETCH *THREADE
: *NOLONGNAME *START *EXECOPS *ARGPARSE *NOEXPORTALL *NODLL (NOCALLBACKANY)
: *NOLIBANSI *NOWSIZEOF *REDIR *ANSIALIAS *DIGRAPH *NOROCONST *ROSTRING
: *TUNE (8) *ARCH (8) *SPILL (128) *MAXMEM (2097152) *NOCOMPACT
: *TARGET (LE, CURRENT) *FLAG (1) *NOTEST (SYM, BLOCK, LINE, PATH, HOOK) *NOOPTIMIZE
: *INLINE (AUTO, REPORT, 100, 1000) *NESTINC (255) *BITFIELD (UNSIGNED)
: *NOINFO
: *NODFP
: *NOVECTOR
: *FLOAT (HEX, FOLD, NOMAF, AFP (NOVOLATILE))
: *STRICT
: *NOCOMPRESS *NOSTRICT_INDUCTION *AGGRCOPY (NOOVERLAP) *CHARS (UNSIGNED)
: *NOIGNERRNO
: *NOINITAUTO
: *NOCSECT
: *NOEVENTS
: *ASSERT (RESTRICT)
: *NORESTRICT
: *OBJECT
: *NOGENASM
: *NOOPTFILE
: *NOSERVICE
: *NOOE
: *NOIPA
: *SEARCH (/'CEE.SCEEH.+')
: *NOLSEARCH
: *NOLOCALE *HALT (16) *PLIST (HOST)
: *NOCONVLIT
: *NOASCII
: *NOGOF *ILP32 *NOWARN64 *NOHGPR *NOHOT *NOMETAL *NOARMODE
: *NOXPLINK (NOBACKCHAIN, NOSTOREARGS, NOCALLBACK, GUARD, OSCALL (NOSTACK))
: *ENUMSIZE (SMALL)
: *NOHALTONMSG
: *NOSUPPRESS
: *NORTCHECK
: *NODEBUG
: *NOSQL
: *NOCICS
: *UNROLL (AUTO)
: *KEYWORD ()
: *NOKEYWORD (asm, typeof)
: *NOSEVERITY
: *NODSAUSER
: *NOINCLUDE
: *NOSMP
: *SYSSTATE (NOASCENV, OSREL (NONE))
: *NOFUNCEVENT
: *NOASM
: *NOASMLIB
Version Macros . . : __COMPILER_VER__=0x42020000 __LIBREL__=0x42020000 __TARGET_LIB__=0x42020000
Language level . . : *ANSI
Source margins . . :
Varying length.: 1 - 32760
Fixed length. . : 1 - 32760
Sequence columns.:
Varying length.: none
Fixed length. . : none
Locale Name . . . : De_DE.IBM-273 2
Code Set. . . . . : IBM-273

```

\*\*\*\*\* E N D O F P R O L O G \*\*\*\*\*

Example of output when locale option is used (Part 1 of 2)

Figure 266. Example of output when locale option is used

```

***** SOURCE *****
LINE  STMT                                          SEQNBR  INCNO
1     ??=pragma filetag("IBM-273")                1
2     #include stdio.h                             2
3
4     int main() ä                                  3
5     1 printf("Hello Worldön");                   4
6     3|                                           5
***** END OF SOURCE *****

```

```

***** INCLUDES *****
INCLUDE FILES --- FILE#  NAME
1     TSCTEST.CEEZ220.SCEEH.H(STDIO)
2     TSCTEST.CEEZ220.SCEEH.H(FEATURES)
3     TSCTEST.CEEZ220.SCEEH.SYS.H(TYPES)
***** END OF INCLUDES *****

```

```

***** MESSAGE SUMMARY *****
Total      Informational(00)      Warning(10)      Error(30)      Severe Error(40)
0           0           0           0           0
***** END OF MESSAGE SUMMARY *****
***** END OF COMPILATION *****

```

*Example of output when locale option is used (Part 2 of 2)*

## The pragma convert directive

You can control the conversion of string literals in your code by using the #pragma convert directive. It allows you to change the assumed code page for character string literals by supplying a codepage value. For more information, see convert in *z/OS XL C/C++ Language Reference*.

For example, if you use an ASCII client machine to write code with string literals and upload it to an EBCDIC server, then your string literals will be converted to EBCDIC. However, if you add the pragma convert ("IS08859-1") directive to your source code, then your string literals will be converted to an ASCII code page.

For example, consider the program in Figure 267 on page 1062. When this program is compiled, the string "Hello World" will be converted to an ASCII string, but the string "Hi There!" will not be converted.



---

```
/* header.h */
#pragma convert("ISO8859-1")
char *text="Hello World";
#pragma convert(pop)

/* test.c */
#pragma comment (user, "A user comment")
#include "header.h"

main () {
    char *text2 ="Hi There!";
}
```

---

Figure 267. Using the `pragma convert` directive

---

## Writing source code in coded character set IBM-1047

There are two reasons why you would want to write source in coded character set IBM-1047.

First, even though z/OS XL C/C++ provides support for multiple coded character sets, other tools may not do so. Tools such as CICS and DB2 may not support source code in any coded character set other than the default coded character set, IBM-1047. If you are using these tools, and you write your code in a code page other than IBM-1047, you will need to use the z/OS XL C/C++ `iconv` utility to convert your code to coded character set IBM-1047 before you can use the tool.

Second, older versions of the C/370 product do not support source in coded character sets other than IBM-1047. This makes it difficult to share code with a site using an older compiler.

---

## Exporting source code to other sites

This section deals with the *exporting* of code from one Latin-1 coded character set to another; that is, writing code that can be run in a locale that uses a different coded character set than the one used to write the source.

To export code, use the `iconv()` utility to convert each source file, header file, and data file to the target coded character set. You can then send all files to the target location for compilation.

**Note:** You must ensure that your code runs in the same locale that it was compiled under before running it with any other locales.

1. Use the `#pragma filetag` directive to tag each source file, header file, and data file.
2. Use message files for all external strings, such as prompts, help screens, and error messages. To write truly portable code, convert these strings to the runtime coded character set in your application code.
3. Use the `setlocale()` function so that the library functions are sensitive to the runtime coded character set.

Ensure that locale-sensitive information, such as decimal points, are displayed appropriately. Use either `nl_langinfo()` or `localeconv()` to obtain this information.

The `setlocale()` function does not change the CEE callable services under the z/OS Language Environment in such areas as date, time, currency, and time zones. Internationalization is specific to z/OS XL C/C++ applications. Also, the z/OS Language Environment CEE callable services do not change the z/OS XL C/C++ locales. For a list of these callable services, see the *z/OS Language Environment Programming Guide*.

4. Compile with the locale specifying coded character set IBM-1047.

If you specify `locale("locale-name")`, your code will run correctly with libraries running in the same coded character set. However, if you compile with a different locale than you run under, you have to ensure that your code has no internal data, and also that all libraries you use are runtime locale sensitive.

For example, consider the following code fragment. If you compile with `locale("De_DE.IBM-273")`, the square brackets are converted to the hex values X'63' and X'FC'. If the default locale you then run under is not "De\_DE.IBM-273", but instead "En\_US.IBM-1047", and you have not used `setlocale()`, the square brackets will be interpreted as Ä and Ü, and the call to `scanf()` will not do what you intended.

```
int main() {
    setlocale(LC_ALL, "");
    :
    rc = scanf("%[1234567890abcdefABCDEF]", hexNum);
    :
}
```

If you only need to run your code locally or export it to a site that has your locale environment, you can solve this problem by using the following coding. This ensures that your code runs with the same locale it was compiled under. Library functions such as `printf()`, `scanf()`, `strfmon()`, and `regcomp()` are sensitive to the current coded character set. The `__LOCALE__` macro is described in "Using predefined macros" on page 1054.

```
int main() {
    setlocale(LC_ALL, __LOCALE__);
    :
    rc = scanf("%[1234567890abcdefABCDEF]", hexNum);
    :
}
```

If you are generating code to export to a site that may not have your locale environment, you should write your code in IBM-1047.

---

## Converting existing work

This section describes some conversion issues and presents some conversion scenarios. It is assumed that existing source code and libraries cannot be quickly converted from mixed coded character sets into a common coded character set; thus a staged approach is recommended.

- Code your new source in one coded character set, preferably IBM-1047. Tag all new source files to make them more portable by putting the `#pragma filetag` directive at the top of each one.
- If you need to interact with existing code, compile your new code using the locale in which the existing code was written.
- If you want to write code in a coded character set that does not have a one-to-one mapping to coded character set IBM-1047 (that is, a coded character set that is not Latin-1), create your own conversion table and compile it with the `genxlt` utility. Use your own conversion table with the `iconv` utility to convert your source code to coded character set IBM-1047.

---

## Considerations with other products and tools

**Note:** Any software tool that scans source code or compiler listings is affected by the introduction of the locale functionality. Tools that read or generate source code now need to recognize the `#pragma filetag` directive. Tools that read listings need to recognize the coded character set in the title header.

Since the following tools scan source code, they may be affected:

- The Debug Tool does not support code written in any coded character set other than IBM-1047.
- Translators such as CICS and DB2 read source files and generate new source files. If they do not, then follow these steps:
  1. Convert the source file to coded character set IBM-1047 using the `iconv` utility.
  2. Remove the `#pragma filetag` directive from the source file, or change it to `??=pragma filetag("IBM-1047")`. Run the source that is in the IBM-1047 coded character set through the appropriate translator, if needed.

---

## Chapter 66. Bidirectional language support

This chapter describes the characteristics of bidirectional languages, and provides an overview of the layout functions for bidirectional languages. For more information on the layout functions see *z/OS XL C/C++ Runtime Library Reference*, and *X/Open Portable Layout Services: Context-dependent and Directional Text*.

---

### Bidirectional languages

Bidirectional languages are languages such as Arabic and Hebrew, that are written and read mainly from right to left, but some portions of the text, such as numbers and embedded Latin languages (e.g. English) are written and read left to right. Additional characteristics of bidirectional languages include:

- visual order versus logical order
- symmetric swapping
- number formats
- cursive (shaping) versus non-cursive

In bidirectional text, it is important to note the difference between the logical order in which the text is processed or read, and the visual order in which the text is displayed. Bidirectional text is usually stored in logical order. For example, assume that the following text is Arabic, then the logical storage would contain:

```
maple street 25 entrance b
```

and the visual display would be (if read from right to left):

```
b ecartne 25 teerts elpam
```

Some characters, such as the greater-than sign, have an implied directional meaning and have a complementary symmetric character with an opposite directional meaning (the less-than sign.) When used within a segment that is presented right-to-left but is inverted (left-to-right) when stored for processing, such a character might have to be replaced by its symmetric sibling to ensure that the correct meaning of the text is preserved. The replacement of such a character by its complement during the transformation of BiDi text is called "symmetrical swapping". Other graphic characters that need symmetrical swapping include the parentheses, square brackets, braces, and so on. Although symmetrical swapping is a characteristic of BiDi languages, it is not always mandatory for the software functions that transform different BiDi language text layouts. Sometimes this function is performed automatically by the workstation hardware or micro code.

Arabic numerals (Latin digits) are those numerals used with Latin text, while Hindi numerals are used within Arabic text, in some of the Arabian countries, like Egypt. However, the Implicit algorithm states the number storage should use Arabic numerals (Latin digit), and be displayed according to the user's settings.

Note that even though the text in the example is displayed right to left, the number "25" is still written left to right. That is because Arabic/Hebrew numbers are written and read left to right.

Arabic is a cursive language. Arabic characters are connected together, and each character has different shapes depending on its location within the word: initial,

middle, final or isolated. Cursive languages are suited to handwriting rather than printing. Arabic is always cursive, whether in books, newspapers, signs or workstation displays. English can be handwritten in a cursive style, and it is often used that way in personal communications, but English is seldom published or displayed in a cursive style. Thus, English is not considered a cursive language.

To simplify processing, characters are usually stored in an unshaped form. (The unshaped form is also referred to as the abstract or basic form.) Shaping takes into account the character being shaped and the characters in its vicinity, and replaces the unshaped, abstract form with the proper shape. For example, in Arabic, the unshaped character would be replaced with the initial, middle, final or isolated shaped character, depending on the context.

Note that Hebrew letters do not use shaping, and numbers used with Hebrew text are always displayed with the same digits as used for English.

Legacy operating systems like MVS used to store Arabic and Hebrew data in their visual format. Sometimes for specific needs, data might be stored in a specific shape, for example initial shape. Currently, most applications store text in its unshaped form in logical order. Reordering and shaping are done at display time. Storing text in its unshaped form in logical order makes it easier to process the data (sorting, comparison).

## Overview of the layout functions

The layout functions are used to handle bidirectional languages correctly, to transform text from a format readable for the user to a format suitable for processing, and vice-versa. The layout functions include the following:

### **m\_create\_layout()**

called at the beginning of the application to create the layout object that will be used by the other layout functions.

### **m\_setvalues\_layout()**

sets the values that will be used inside the transform. `m_setvalues_layout()` must be called before calling `m_transform_layout` or `m_wtransform_layout`. This function is optional. Use this function if you need to change the values for the bidirectional attributes. You can eliminate it from the application, and use a modifier instead.

### **m\_getvalues\_layout()**

queries the current layout values within a layout object.

### **m\_transform\_layout()**

does the actual processing to convert the text format between different bidirectional layouts, according to the settings of the `LayoutObject`. Nothing will change if this function (or its wide character equivalent) is not called inside the application.

### **m\_wtransform\_layout()**

works the same as `m_transform_layout()`, except that it handles Unicode wide characters (`wchar_t`).

### **m\_destroy\_layout()**

called at the end of the application to destroy the layout object, and free up the allocated memory used by the layout object.

Those functions can be used to convert text from logical (implicit) unshaped forms to visual (display) shaped forms and vice versa. The layout functions also handle conversion of numerals.

Table 360 lists supported layout attributes and their corresponding values. These are the attributes most commonly used to provide Bidi support. Each attribute has input and output values that can be specified for the layout transformation process. The default value for each attribute is indicated in the table.

A full list of attributes and values is available in *X/Open Portable Layout Services: Context-dependent and Directional Text*. Some attributes listed in Table 360 are specific to the z/OS implementation and are noted with an asterisk (\*) symbol.

You can set Bidi Layout Values in two ways:

- The `m_setvalues_layout()` function requires the Layout Attribute Names and Values to be specified by using keywords presented in columns 1 and 2.
- The `m_create_layout()` function allows a string to be passed to set the values. This string is preceded with the "@ls" characters and requires the names and values to be used as displayed in column 3. Multiple attribute and value pairs can be separated by commas in the following form:

```
@ls <attribute_name1>=<input1>:<output1>,<br><attribute_name2>=<input2>:<output2>...
```

Example:

```
@ls orientation=ltr:ltr,typeoftext=implicit:visual,<br>numerals=nominal:national,swapping=no:yes,<br>bidiroundtrip=true
```

Table 360. Layout attribute and values

Attribute Name	Attribute values	Modifier layout string names and values (@ls)		Description
		Name:	Values:	
Orientation	ORIENTATION_CONTEXTUAL ORIENTATION_LTR (Default) ORIENTATION_RTL	Name:	orientation=	The direction of the text.
		Values:	contextual ltr rtl	
Context	CONTEXT_LTR (Default) CONTEXT_RTL	Name:	context=	Contextual orientation when the orientation attribute is set to ORIENTATION_CONTEXTUAL
		Values:	ltr rtl	
TypeofText	TEXT_EXPLICIT TEXT_IMPLICIT (Input default) TEXT_VISUAL (Output default)	Name:	typeoftext=	Type of the text.
		Values:	explicit implicit visual	
Swapping	SWAPPING_NO (Input default) SWAPPING_YES (Output default)	Name:	swapping=	Specifies if symmetric swapping is enabled.
		Values:	no yes	
Numerals	NUMERALS_CONTEXTUAL (Output default in Arabic locale) NUMERALS_NATIONAL NUMERALS_NOMINAL (Input default, Output default in Hebrew locale)	Name:	numerals=	How numerals are shaped. (Only valid for Arabic.)
		Values:	contextual national nominal	

Table 360. Layout attribute and values (continued)

Attribute Name	Attribute values	Modifier layout string names and values (@ls)		Description
TextShaping	TEXT_NOMINAL (Input default, Output default in Hebrew locale) TEXT_SHAPED (Output default in Arabic locale)	Name:	shaping=	Specifies if text is to be shaped. (Only valid for Arabic.)
		Values:	nominal shaped	
ShapeCharset	IBM-1046 IBM-1089 IBM-1256 IBM-420 IBM-424 IBM-425 IBM-53668 IBM-864 ISO8859-6 UCS-2 (Default)	Name:	shapcharset=	Code set of the output buffer to result from layout transformation.
		Values	IBM-1046 IBM-1089 IBM-1256 IBM-420 IBM-424 IBM-425 IBM-53668 IBM-864 ISO8859-6 UCS-2 (Default)	
InputCharset*	IBM-1046 IBM-1089 IBM-1256 IBM-420 IBM-424 IBM-425 IBM-53668 IBM-864 ISO8859-6 UCS-2	N/A		Code set of the input buffer to use in layout transformation. The default value is the code set of the loaded locale.
BidiRoundTrip*	BIDIROUNDTRIP_OFF (Default) BIDIROUNDTRIP_ON	Name:	bidiroundtrip=	Specifies if the Bidi roundtrip algorithm is enabled. To take proper effect, BidiRoundTrip must be enabled in both legs of the layout transformations that complete the roundtrip.
		Values:	false true	

### **m\_create\_layout( )**

This function creates a `LayoutObject` associated with the locale identified by `attrobj`. The `LayoutObject` is an opaque object containing all the data and methods necessary to perform the layout operations on context-dependent or directional characters of the locale identified by the `attrobj`. The memory for the `LayoutObject` is allocated by `m_create_layout( )`. The `LayoutObject` created has default layout values. (If the `modifier` argument is not `NULL`, the layout values specified by the `modifier` overwrite the default layout values associated with the locale).

```
#include <sys/layout.h>
LayoutObject m_create_layout(const AttrObject attrobj, const char* modifier);
```

### **attrobj argument**

Is or may be an amalgam of many opaque objects. A locale object is just one example of the type of object that can be attached to an attribute object. The `attrobj` argument specifies a name that is usually associated with a locale category.

**modifier argument**

Can be used to announce a set of layout values when the LayoutObject is created.

**m\_setvalues\_layout( )**

This function is used to change the layout values of a LayoutObject.

```
#include <sys/layout.h>
int m_setvalues_layout(LayoutObject layout_object, const LayoutValues values,
    int *index_returned);
```

**layout\_object argument**

Specifies a LayoutObject returned by the m\_create\_layout() function.

**values argument**

Specifies the list of layout values that are to be changed. The values are written into the LayoutObject and may affect the behavior of subsequent layout functions.

**m\_getvalues\_layout( )**

This function is used to query the current settings of the layout values within a Layout Object.

```
#include <sys/layout.h>
int m_getvalues_layout(const LayoutObject layout_object, LayoutValues values,
    int *index_returned);
```

**layout\_object argument**

Specifies a Layout Object returned by the m\_create\_layout( ) function.

**values argument**

Specifies the list of layout values that are to be queried. Each value element of a LayoutValueRec must point to a location where the layout value is stored. That is, if the layout value is of type T , the argument must be of type \*T . The values are queried from the Layout Object and represent its current setting. It is the user's responsibility to manage the memory allocation for the layout values queried. If the layout value name has QueryValueSize ORed to it, instead of the setting of the layout value, only its size is returned. This option can be used by the caller to determine the amount of memory needed to be allocated for the layout values queried.

**m\_transform\_layout ( )**

This function performs layout transformations (reordering and shaping), or it may provide additional information needed for layout transformation (such as the expected size of the transformed layout, the nesting level of different segments in the text and cross references between the locations of the corresponding elements before and after the layout transformation). Both the input text and output text are character strings. The m\_transform\_layout( ) function transforms the input text in InpBuf according to the current layout values in layout\_object. Any layout value whose value type is LayoutTextDescriptor describes the attributes of the InpBuf and OutBuf arguments. If the attributes are the same for both InpBuf and OutBuf, a null transformation is performed with respect to that specific layout value. The InpBuf argument specifies the source text to be processed. The InpSize argument is the number of bytes within InpBuf to be processed by the transformation. Its value will not change after return from the transformation.



```

#include <sys/layout.h>
int m_transform_layout(LayoutObject layout_object,
                      const char *InpBuf,
                      const size_t InpSize,
                      void *OutBuf,
                      size_t *Outsize,
                      size_t *InpToOut,
                      size_t *OutToInp,
                      unsigned char *Property,
                      size_t *InpBufIndex);

```

**LayoutObject argument**

Specifies the Layout Object returned by m\_create\_layout().

**InpBuf argument**

Corresponds to the input string that the layout functions will process.

**InpSize argument**

Gives the input size of the input string specified by the InpBuf argument.

**Note:** If you need to pass -1 as a value for InpSize, you must cast it using (size\_t)-1.

**OutBuf argument**

Any transformed data is stored here. This buffer will contain the data after converting it to the specified layout values and output code page.

**Outsize argument**

Gives the number of bytes in the Output Buffer.

**InpToOut mapping argument**

A cross-reference from each InpBuf code element to the transformed data. The cross-reference relates to the data in InpBuf starting with the first element that InpBufIndex points to (and not necessarily starting from the beginning of the InpBuf).

**OutToInp mapping argument**

A cross-reference to each InpBuf code element from the transformed data. The cross-reference relates to the data in InpBuf starting with the first element that InpBufIndex points to (and not necessarily starting from the beginning of the InpBuf).

**Property argument**

A weighted value that represents peculiar input string transformation properties with different connotations. If this argument is not a NULL pointer, it represents an array of values with the same number of elements as the source sub string text before the transformation. Each byte will contain relevant "property" information of the corresponding element in InpBuf starting from the element pointed by InpBufIndex.

**InpBufIndex argument**

InpBufIndex is an offset value to the location of the transformed text. When m\_transform\_layout( ) is called, InpBufIndex contains the offset to the element in InpBuf that will be transformed first. (Note that this is not necessarily the first element in InpBuf). At the return from the transformation, InpBufIndex contains the offset to the first element in the InpBuf that has not been transformed. If the entire sub string has been transformed successfully, InpBufIndex will be incremented by the amount defined by InpSize.

## m\_wtransform\_layout( )

The `m_wtransform_layout` is the same as `m_transform_layout`, except that it takes Unicode (`wchar_t *`) as an input buffer .

```
#include <sys/layout.h>
int m_wtransform_layout(LayoutObject layout_object,
    const wchar_t *InpBuf,
    const size_t InpSize, void *OutBuf,
    size_t *Outsize,
    size_t *InpToOut, size_t *OutToInp,
    unsigned char *Property,
    size_t *InpBufIndex );
```

## m\_destroy\_layout( )

This function destroys the layout object and frees up the allocated memory used by the layout object.

```
#include <sys/layout.h>
int m_destroy_layout(const LayoutObject layoutobject);
```

## Using the layout functions

This section contains examples to illustrate how to call the BIDI layout engine. Note that to use the Bidi roundtrip algorithm, the option must be enabled in both legs of a layout transformation.

The example in Figure 268 sets the option using a layout string modifier.

---

```
Layout Transformation #1:
-----
"@ls orientation=ltr:ltr, typeoftext=visual:implicit,
bidiroundtrip=true"

Layout Transformation #2:
-----
"@ls orientation=ltr:ltr, typeoftext=implicit:visual,
bidiroundtrip=true"
```

---

*Figure 268. Example of using a layout string modifier*

Figure 269 demonstrates how to use the `m_setvalues_layout()` function to set the option.

---

```
LayoutValues layout = (LayoutValues)
calloc(2, sizeof(LayoutValueRec));
layout 0 .name = BidiRoundTrip;
layout 0 .value = (void *) BIDIRoundTrip_ON;
layout 1 .name = 0;
```

---

*Figure 269. Example of using the m\_setvalues\_layout() function*

To use the layout functions, perform the following steps.

1. Include the `sys/layout.h` header file to define the values and function prototypes.

---

```
#include <sys/layout.h>
```

---

## 2. Declare the program variables.

---

```
LayoutObject plh;
int error = 0, index;
size_t insize = 9, outsize;
LayoutValues layout;
LayoutTextDescriptor set_desc;

char *inbuffer;
char *outbuffer;
char *inShape;
char *outShape;
char *myModifier=
    "@!stypetext=implicit:visual,shaping=nominal:shaped,orientation=ltr:rtl";
```

---

In the first line, declare a `LayoutObject` called "plh". This is the layout object that `m_create_layout()` creates later when invoked. `index` is the index of the returned error. `insize` is the size of the input buffer, and `outsize` is the size of the output buffer. The four integer variables in the second and third lines will be used later in the call of `m_setvalues_layout()` and `m_transform_layout()`. In the fourth line, declare a `LayoutValues` variable called "layout" and in the fifth line declare a `LayoutTextDescriptor` called "set\_desc". These two variables are very important. They will be used with `m_setvalues_layout()` in the form of input/output pairs to specify new input and output values for each one of the specified attributes. The next two lines add four strings (`char *`), that will be used as the input buffer, output buffer, input code page and, finally, the output code page. The last line adds a string that specifies the modifier to be used as specified earlier in the `m_create_layout()` function to create the layout object.

## 3. Allocate memory to the declared strings, layout values, layout text descriptor, and write the contents of the input buffer.

---

```
inbuffer = (char *)malloc(insize*sizeof(char));
outbuffer = (char *)malloc(outsize*sizeof(char));
layout = (LayoutValues)malloc(6*sizeof(LayoutValueRec));
set_desc = (LayoutTextDescriptor)malloc(3*sizeof(LayoutTextDescriptorRec));
inShape = (char*) malloc(20 * sizeof(char));
outShape = (char*) malloc(20 * sizeof(char));
inbuffer[0] = 0xB0;
inbuffer[1] = 0xB1;
inbuffer[2] = 0xB2;
inbuffer[3] = 0xBF;
inbuffer[4] = 0x40;
inbuffer[5] = 0x9A;
inbuffer[6] = 0x75;
inbuffer[7] = 0x58;
inbuffer[8] = 0xDC;
```

---

The values of the input buffer are added one by one as an array of characters, but several alternatives could be used. For example, you can read the input buffer as a string from a file, or get it from another application.

## 4. Call the `m_create_layout()` function to create a layout object "plh".

---

```
plh = m_create_layout("Ar_AA",myModifier);
```

---

In the preceding example, the layout object "plh" is created with the locale Ar\_AA with the modifier myModifier.

5. At this point of the program, there are two options: call `m_setvalues_layout()` or call the `m_transform_layout()` (or `m_wtransform_layout()`) directly.

Specify the input/output layout values. The first two lines below specify the two strings used as the input and output code pages. These two strings will be used by the other functions to specify the input code page for the input buffer and the output code page for the output buffer.

---

```
strcpy(outShape,"ibm-420");
strcpy(inShape,"ibm-425");

set_desc[0].inp = ORIENTATION_LTR;
set_desc[0].out = ORIENTATION_LTR;
set_desc[1].inp = TEXT_IMPLICIT;
set_desc[1].out = TEXT_VISUAL;
set_desc[2].inp = TEXT_NOMINAL;
set_desc[2].out = TEXT_SHAPED;
```

---

Add the input/output layout text descriptor pairs. These pairs are in the form of input descriptor and output descriptor; for example, the first statement specifies that the input orientation will be "orientation-left-to-right" and the second statement specifies that the output orientation will be also "orientation-left-to-right". All the above pairs follow the same rule to define the input/output pairs.

---

```
layout[0].name = ShapeCharset;
layout[0].value = (char *)outShape;

layout[1].name = InputCharset;
layout[1].value = (char *)inShape;

layout[2].name = Orientation;
layout[2].value = (LayoutTextDescriptor)&set_desc[0];

layout[3].name = TypeOfText;
layout[3].value = (LayoutTextDescriptor)&set_desc[1];

layout[4].name = TextShaping;
layout[4].value = (LayoutTextDescriptor)&set_desc[2];

layout[5].name = 0;
```

---

In the preceding lines, "set\_desc" pairs create the new layout values attributes. Each one of these statements will be in the form of attribute\_name/attribute\_value pairs, for example in the fifth and sixth statements "Orientation" is the attribute name and set\_desc[0] (as defined above) is the attribute value. The first two statements are used to declare the output code page and the following two lines are used to specify the input code page.

Call the `m_setvalues_layout()` function.

---

```
if((error =m_setvalues_layout(plh,layout,&index)))
printf("\n An error %d occurred in setting the value number %d\n",error,index);
```

---

Invoke `m_setvalues_layout()` using the layout object "plh", the layout values "layout" and an integer "index". If `m_setvalues_layout()` could not set any one of the layout values attributes, it will return -1 in the integer variable called "error", and also return the index of the layout value that caused the problem.

6. Call the `m_transform_layout()` function. The `m_transform_layout()` and `m_wtransform_layout()` functions are the same, except that `m_wtransform_layout()` is used for wide character (`wchar_t`). Both functions will do the actual reordering and shaping of the input buffer using the layout object (plh) created in step 4.

---

```
m_transform_layout(plh,inbuffer,insize,outbuffer,&outsize,NULL,
NULL,NULL,NULL);
```

---

**plh** The Layout Object returned by `m_create_layout()`.

**inbuffer**

Corresponds to the input string to the function that the layout functions will process.

**insize** Gives the input size of the input string specified by the Input Buffer argument.

**outbuffer**

Any transformed data is stored here. This buffer will contain the data after converting it to the specified output code page.

**outsize**

Gives the number of bytes in the Output Buffer.

The last four parameters are given here as NULL and they represent Input To Output Mapping, Output To Input Mapping, Property and Input Buffer Index as described above in the Overview of the Layout Functions. Each of these output arguments may be NULL to specify that no output is desired for the specific argument.

7. Call the `m_destroy_layout()` function. This function must be called at the end of the program to destroy the layout object or to free up the allocated memory used by the layout object.

---

```
m_destroy_layout(plh);
```

---

Finally, Figure 270 on page 1075 is sample program (CCNGBID1) that shows how the bidirectional layout API are used.

```

*****
/* This is a simple program that explains how the layout API's are used */
/* This program will convert a simple implicit unshaped Arabic string */
/* to a visual shaped Arabic string . */
#include <sys/layout.h>
#include <stdio.h>

void main(int argc,char** argv)
{
    LayoutObject plh;
    int error = 0;
    int index;
    LayoutValues layout;
    LayoutTextDescriptor set_desc;
    size_t insize = 9,outsized = 9;

    char *inbuffer=NULL;
    char *outbuffer=NULL;
    char *inShape=NULL;
    char *outShape=NULL;
    char

*myModifier=@"@lstypeoftext=implicit:visual,shaping=nominal:shaped,orientation=ltr:rtl";

    inbuffer =(char *)malloc((insize+1)*sizeof(char) );
    outbuffer=(char *)malloc((outsized+1)*sizeof(char)) ;

    layout = (LayoutValues)malloc(6*sizeof(LayoutValueRec));
    set_desc = (LayoutTextDescriptor)malloc(3*sizeof(LayoutTextDescriptorRec));

    inShape = (char*) malloc(8 * sizeof(char));
    outShape = (char*) malloc(8 * sizeof(char));

    inbuffer[0] = 0xB0; /* These are the HEX code for Arabic characters in the IBM-425 codepage */
    inbuffer[1] = 0xB1;
    inbuffer[2] = 0xB2;
    inbuffer[3] = 0xBF;
    inbuffer[4] = 0x40;
    inbuffer[5] = 0x9A;
    inbuffer[6] = 0x75;
    inbuffer[7] = 0x58;
    inbuffer[8] = 0xDC;

```

*Example of bidirectional layout API's (Part 1 of 2)*

*Figure 270. Example of bidirectional layout API's*

```

plh = m_create_layout("Ar_AA",myModifier);

strcpy(outShape,"ibm-420");
strcpy(inShape,"ibm-425");

set_desc[0].inp = ORIENTATION_LTR;
set_desc[0].out = ORIENTATION_LTR;

set_desc[1].inp = TEXT_IMPLICIT;
set_desc[1].out = TEXT_VISUAL;

set_desc[2].inp = TEXT_NOMINAL;
set_desc[2].out = TEXT_SHAPED;

layout[0].name = ShapeCharset;
layout[0].value = (char *)outShape;

layout[1].name = InputCharset;
layout[1].value = (char *)inShape;

layout[2].name = Orientation;
layout[2].value = (LayoutTextDescriptor)&set_desc[0];

layout[3].name = TypeOfText;
layout[3].value = (LayoutTextDescriptor)&set_desc[1];

layout[4].name = TextShaping;
layout[4].value = (LayoutTextDescriptor)&set_desc[2];

layout[5].name = 0;

if( error=m_setvalues_layout(plh,layout,&index)
    printf("\n An error %d occurred in setting the value number %d\n",error,index);
m_transform_layout(plh,inbuffer,insize,outbuffer,&outsize,NULL,NULL,NULL,NULL);
m_destroy_layout(plh);

if(inbuffer)
    free(inbuffer);
if(outbuffer)
    free(outbuffer);
if(set_desc)
    free(set_desc);
if(layout)
    free(layout);
if(inShape)
    free(inShape);
if(outShape)
    free(outShape);
}

```

*Example of bidirectional layout API's (Part 2 of 2)*

---

## Part 9. Appendixes





---

## Appendix A. POSIX character set

POSIX 1003.2, section 2.4, specifies the characters that are in the portable character set. The following table lists the characters in the portable character set with their symbolic name, the GCGID, and the graphic symbol for the character. Some of the characters (the hyphen, for example) also have alternate symbolic names. The input files for the localedef utility, the charmap file and the locale definition file, are coded using the characters in the portable character set.

Symbolic Name	Alternate Name	Character
<NUL>		
<alert>	<SE08>	
<backspace>	<SE09>	
<tab>	<SE10>	
<newline>	<SE11>	
<vertical-tab>	<SE12>	
<form-feed>	<SE13>	
<carriage-return>	<SE14>	
<space>	<SP01>	
<exclamation-mark>	<SP02>	!
<quotation-mark>	<SP04>	"
<number-sign>	<SM01>	#
<dollar-sign>	<SC03>	\$
<percent-sign>	<SM02>	%
<ampersand>	<SM03>	&
<apostrophe>	<SP05>	'
<left-parenthesis>	<SP06>	(
<right-parenthesis>	<SP07>	)
<asterisk>	<SM04>	*
<plus-sign>	<SA01>	+
<comma>	<SP08>	,
<hyphen>	<SP10>	-
<hyphen-minus>	<SP10>	-
<period>	<SP11>	.
<slash>	<SP12>	/
<zero>	<ND10>	0
<one>	<ND01>	1
<two>	<ND02>	2
<three>	<ND03>	3
<four>	<ND04>	4
<five>	<ND05>	5
<six>	<ND06>	6

Symbolic Name	Alternate Name	Character
<seven>	<ND07>	7
<eight>	<ND08>	8
<nine>	<ND09>	9
<colon>	<SP13>	:
<semicolon>	<SP14>	;
<less-than-sign>	<SA03>	<
<equals-sign>	<SA04>	=
<greater-than-sign>	<SA05>	>
<question-mark>	<SP15>	?
<commercial-at>	<SM05>	@
<A>	<LA02>	A
<B>	<LB02>	B
<C>	<LC02>	C
<D>	<LD02>	D
<E>	<LE02>	E
<F>	<LF02>	F
<G>	<LG02>	G
<H>	<LH02>	H
<I>	<LI02>	I
<J>	<LJ02>	J
<K>	<LK02>	K
<L>	<LL02>	L
<M>	<SM02>	M
<N>	<LN02>	N
<O>	<LO02>	O
<P>	<LP02>	P
<Q>	<LQ02>	Q
<R>	<LR02>	R
<S>	<LS02>	S
<T>	<LT02>	T
<U>	<LU02>	U
<V>	<LV02>	V
<W>	<LW02>	W
<X>	<LX02>	X
<Y>	<LY02>	Y
<Z>	<LZ02>	Z
<left-square-bracket>	<SM06>	[
<backslash>	<SM07>	\
<reverse-solidus>	<SM07>	\
<right-square-bracket>	<SM08>	]
<circumflex>	<SD15>	^

Symbolic Name	Alternate Name	Character
<circumflex-accent>	<SD15>	^
<underscore>	<SP09>	_
<low-line>	<SP09>	_
<grave-accent>	<SD13>	`
<a>	<LA01>	a
<b>	<LB01>	b
<c>	<LC01>	c
<d>	<LD01>	d
<e>	<LE01>	e
<f>	<LF01>	f
<g>	<LG01>	g
<h>	<LH01>	h
<i>	<LI01>	i
<j>	<LJ01>	j
<k>	<LK01>	k
<l>	<LL01>	l
<m>	<LM01>	m
<n>	<LN01>	n
<o>	<LO01>	o
<p>	<LP01>	p
<q>	<LQ01>	q
<r>	<LR01>	r
<s>	<LS01>	s
<t>	<LT01>	t
<u>	<LU01>	u
<v>	<LV01>	v
<w>	<LW01>	w
<x>	<LX01>	x
<y>	<LY01>	y
<z>	<LZ01>	z
<left-brace>	<SM11>	{
<left-curly-bracket>	<SM11>	{
<vertical-line>	<SM13>	
<right-brace>	<SM14>	}
<right-curly-bracket>	<SM14>	}
<tilde>	<SD19>	~

With z/OS XL C/C++, the localedef utility uses code page IBM-1047 as the definition of the code points for the characters in the *Portable Character Set*. Therefore, the default values for the escape-char and comment-char are the code points from the IBM-1047 code page.

There are some coded character sets, such as the Japanese Katakana coded character set 290, that have code points for the lowercase characters different from the code points for the lowercase characters in the set IBM-1047. A charmap file or locale definition file cannot be coded using these coded character sets.

---

## Appendix B. Mapping variant characters for z/OS XL C/C++

If you are running a programmable workstation using host emulation software, you must:

1. Remap the hexadecimal values for the variant characters. Remapping will send the values that are correct for the installed z/OS XL C/C++ compiler to the host system. For instructions, see “Specifying the appropriate code page for the compiler.”
2. Ensure that your current keyboard input generates the hexadecimal values that are expected by the z/OS XL C/C++ compiler and its library. For instructions, see “Testing the display of variant characters.”
3. Enable your ISPF editor to support local use of variant characters. For instructions, see “Inserting and viewing square brackets during an ISPF edit session” on page 1086.

**Note:** See LOCALE|NOLOCALE and other appropriate sections in *z/OS XL C/C++ User’s Guide* for information on the option and the list of IBM-supported locales available for use at compile time or run time. The default C locale is supported by code page IBM-1047; therefore the default encoding of variant characters is as shown in Figure 274 on page 1089. Consult your system programmer for the coded character set that your installation uses.

---

### Specifying the appropriate code page for the compiler

To specify the code page based on the compiler version, use the `#pragma filetag` directive conditionally in the source and header file. The syntax is shown below, where *codepage* is the codepage in which the source code is written.

```
??=ifdef __COMPILER_VER__  
    ??=pragma filetag ("codepage")  
??=endif
```

**Note:** If you are running standard 3270 emulation in the U.S., your workstation software most likely uses code page 37. You can then use this alternative by specifying IBM-037 as *codepage*.

---

### Testing the display of variant characters

If you use a programmable workstation or a 3270 terminal, you can follow Figure 271 on page 1084 to ensure that the host system uses the correct hexadecimal values to display the variant characters. See `iconv` in *z/OS XL C/C++ User’s Guide* for more information on this utility. See “Inserting and viewing square brackets during an ISPF edit session” on page 1086 for instructions to insert square brackets into a C/C++ source file.

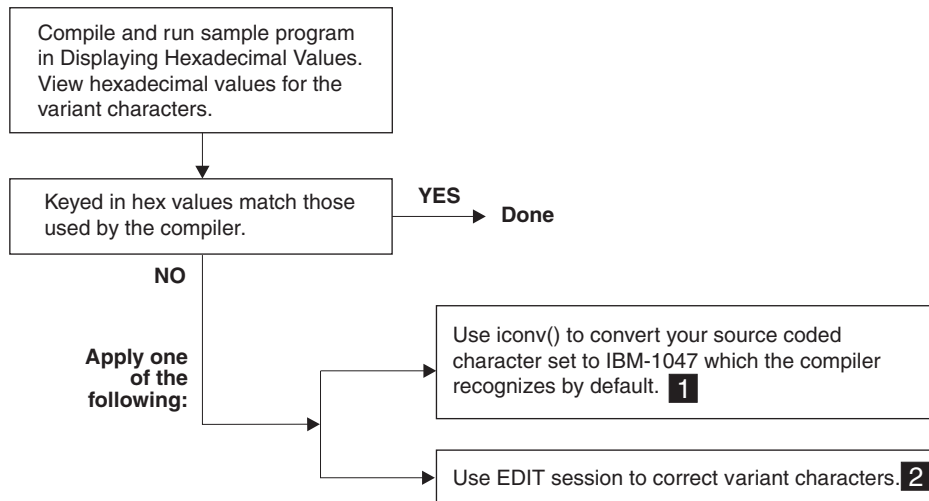

Figure 271. Variant characters

## Displaying hexadecimal values

To ensure that your current keys generate the hexadecimal values that are expected by the z/OS XL C/C++ compiler and its library:

1. Create the input file MYFILE.DAT, typed in the following order on a single line, without spaces between them:
  - backslash \
  - right square bracket ]
  - left square bracket [
  - right brace }
  - left brace {
  - circumflex ^
  - tilde ~
  - exclamation mark !
  - number sign #
  - vertical line |

**Note:** These ten variant characters are selected because they are syntactically important to the z/OS XL C/C++ compiler.

2. Run the program Figure 272 on page 1085 to display the following information:
  - Selected hexadecimal values for the variant characters that your current setup uses:
  - The values that the compiler and library expect for mapping the keyboard.
3. Perform the following steps until the hexadecimal values for the variant characters that your current setup matches the values that the compiler and library expect for mapping the keyboard.
  - a. Use the values that the compiler and library expect for mapping the keyboard to edit the input file MYFILE.DAT.
  - b. Run the program CCNGMV1 again.

## Sample program

CCNGMV1 in Figure 272 performs the following actions:

- Reads the ten characters from MYFILE.DAT.
- Queries the current compile time locale for the character values that compiler would expect.
- Generates the codes as shown in the column EXPECTED BY COMPILER.

```
/* this example will display hexadecimal values for the variant */
/* characters */

#include <stdio.h>
#include <locale.h>
#include <variant.h>
#include <stdlib.h>

void read_user_data(char *, int);
void main() {
    char *user_char, *compiler_char;

    struct variant *compiler_var_char;
    int num_var_char, index;
    char *code_set;
    char *char_names[]={ "backslash",
                          "right bracket",
                          "left bracket",
                          "right brace",
                          "left brace",
                          "circumflex",
                          "tilde",
                          "exclamation mark",
                          "number sign",
                          "vertical line"};

    num_var_char=sizeof(char_names)/sizeof(char *);
    if ((user_char=(char*)calloc(num_var_char, 1)) == NULL)
    {
        printf("Error: Unable to allocate the storage\n");
        exit(99);
    }

    read_user_data(user_char, num_var_char);
    /* managed to read the users' characters from the file */

    code_set="default IBM-1047";
    compiler_char="\xe0\xbd\xad\xd0\xc0\x5f\xa1\x5a\x7b\x4f";
                                     /* standard compiler code page */

    printf("Compiler and library code page is : %s\n\n", code_set);
    printf("                Variant character values:\n");
    printf(" %16s      expected by compiler  your current\n", "");
    for (index=0; index<num_var_char; index++)
        printf(" %16s :      %X                %X\n",
               char_names[index], compiler_char[index], user_char[index]);
    exit(0);
}
```

*CCNGMV1: Displaying hexadecimal values (Part 1 of 2)*

*Figure 272. CCNGMV1: Displaying hexadecimal values*



```

void read_user_data(char* char_array, int num_var_char)
{
    FILE *stream;
    int num;

    if (stream = fopen ("myfile.dat", "rb"))
        if (! (num = fread(char_array, 1, num_var_char, stream)))
        {
            printf("Error: Unable to read from the file\n");
            exit(99);
        }
        else { ;}
    else
    {
        printf("Error: Unable to open the file\n");
        exit(99);
    }
    fclose(stream);
    return;
}

```

*CCNGMV1: Displaying hexadecimal values (Part 2 of 2)*

---

## Inserting and viewing square brackets during an ISPF edit session

When your workstation is sending correct hexadecimal values for the square brackets to the host system, you might find that they are still not correctly displayed during by ISPF. If you are using a programmable workstation or a 3270 terminal, you should include the sample ISPF macro CCNGMV2 in a regular CLIST library that is concatenated to the ddname SYSPROC. CCNGMV2 supports ISPF display of the "[" and "]" characters in text, trigraph, or hex form. You can toggle through the three settings.

**Note:** If you are using 3279-S3G-1 with ISPF, z/OS batch, or TSO, see “Displaying square brackets when using ISPF on 3279 emulation” on page 1087.

After you reset the environment by specifying the appropriate code page for the compiler, follow these steps:

1. Start ISPF and open a C or C++ source file with square brackets.
2. Run CCNGMV2 before editing to convert the compiler recognizable hexadecimal values of the square brackets to trigraphs.
3. Run CCNGMV2 again to convert the trigraphs to displayable characters.
4. Edit your C or C++ source code.
5. Run the CCNGMV2 macro again to convert the displayable characters back to the original hexadecimal values.
6. Save and file the C source file.

### ISPF macro CCNGMV2

CCNGMV2 in Figure 272 on page 1085 is sample ISPF macro for displaying square brackets.

---

```

/* this ISPF macro can be used to display square brackets in different
/* formats

PROC 0
ISREDIT MACRO

SET RP = &STR()
/* Symbolic values for 6 C language symbols.
/* 1. left bracket, EBCDIC hex value
/* 2. right bracket, EBCDIC hex value
/* 3. left bracket, trigraph
/* 4. right bracket, trigraph
/* 5. left bracket, square
/* 6. right bracket, square
SET LBRACKET_HEX = X'AD'
SET RBRACKET_HEX = X'BD'
SET LBRACKET_TRI = &STR(??(
SET RBRACKET_TRI = &STR(??&RP)
SET LBRACKET_SQR = X'BA' /* LBRACKET_SQR = HEX BA */
SET RBRACKET_SQR = X'BB' /* RBRACKET_SQR = HEX BB */

ISREDIT FIND &LBRACKET_HEX ALL NX
ISREDIT (N1) = FIND_COUNTS
ISREDIT FIND &RBRACKET_HEX ALL NX
ISREDIT (N2) = FIND_COUNTS
IF (&N1 ^= &N2) THEN WRITE .....UNBALANCED HEX BRACKETS
IF (&N1 > 0) THEN DO
  ISREDIT CHANGE &LBRACKET_HEX &LBRACKET_TRI ALL NX
  ISREDIT CHANGE &RBRACKET_HEX &RBRACKET_TRI ALL NX
  EXIT
END

ISREDIT FIND &LBRACKET_TRI ALL NX
ISREDIT (N1) = FIND_COUNTS
ISREDIT FIND &RBRACKET_TRI ALL NX
ISREDIT (N2) = FIND_COUNTS
IF (&N1 ^= &N2) THEN WRITE .....UNBALANCED TRIGRAPH
IF (&N1 > 0) THEN DO
  ISREDIT CHANGE &LBRACKET_TRI &LBRACKET_SQR ALL NX
  ISREDIT CHANGE &RBRACKET_TRI &RBRACKET_SQR ALL NX
  EXIT
END

ISREDIT FIND &LBRACKET_SQR ALL NX
ISREDIT (N1) = FIND_COUNTS
ISREDIT FIND &RBRACKET_SQR ALL NX
ISREDIT (N2) = FIND_COUNTS
IF (&N1 ^= &N2) THEN WRITE .....UNBALANCED SQUARE BRACKETS
IF (&N1 > 0) THEN DO
  ISREDIT CHANGE &LBRACKET_SQR &LBRACKET_HEX ALL NX
  ISREDIT CHANGE &RBRACKET_SQR &RBRACKET_HEX ALL NX
  EXIT
END

```

---

Figure 273. Sample ISPF macro for displaying square brackets

## Displaying square brackets when using ISPF on 3279 emulation

If you are using a 3279-S3G-1 with ISPF, z/OS batch, or TSO, you should have the APL keys on your keyboards.

1. Go to ISPF 0.1 and set the terminal type to 3278A.
2. Open the file that has the square brackets in the ISPF editor.
3. Whenever you want to enter square brackets:
  - a. Press ALT APLon.

- b. Enter a bracket "[" or "]".
  - "[" is mapped to = X'AD'.
  - "]" is mapped to = X'BD'.
- c. Press ALT APLOff.

## Appendix C. z/OS XL C/C++ code point mappings

This information provides figures that show the first and second nybbles of the hexadecimal digits that comprise the code point mappings for code page IBM-1047 and the APL code page 293.

Figure 274 shows the Latin-1/Open Systems code point mappings for code page IBM-1047 .

HEX DIGITS 1ST → 2ND ↓	4-	5-	6-	7-	8-	9-	A-	B-	C-	D-	E-	F-
-0	(SP) SP010000	& SM030000	- SP100000	ø LO610000	Ø LO620000	° SM190000	μ SM170000	¬ SM660000	{ SM110000	}	\ SM070000	0 ND100000
-1	(RSP) SP300000	é LE110000	/ SP120000	É LE120000	a LA010000	j LJ010000	~ SD190000	£ SC020000	A LA020000	J LJ020000	÷ SA060000	1 ND010000
-2	â LA150000	ê LE150000	Â LA160000	Ê LE160000	b LB010000	k LK010000	s LS010000	¥ SC050000	B LB020000	K LK020000	S LS020000	2 ND020000
-3	ä LA170000	ë LE170000	Ä LA180000	Ë LE180000	c LC010000	l LL010000	t LT010000	· SD630000	C LC020000	L LL020000	T LT020000	3 ND030000
-4	â LA130000	è LE130000	À LA140000	È LE140000	d LD010000	m LM010000	u LU010000	© SM520000	D LD020000	M LM020000	U LU020000	4 ND040000
-5	á LA110000	í LI110000	Á LA120000	Í LI120000	e LE010000	n LN010000	v LV010000	§ SM240000	E LE020000	N LN020000	V LV020000	5 ND050000
-6	ã LA190000	î LI150000	Ã LA200000	Ï LI160000	f LF010000	o LO010000	w LW010000	¶ SM250000	F LF020000	O LO020000	W LW020000	6 ND060000
-7	å LA270000	ï LI170000	Å LA280000	Ï LI180000	g LG010000	p LP010000	x LX010000	¼ NF040000	G LG020000	P LP020000	X LX020000	7 ND070000
-8	ç LC410000	ì LI130000	Ç LC420000	Ì LI140000	h LH010000	q LQ010000	y LY010000	½ NF010000	H LH020000	Q LQ020000	Y LY020000	8 ND080000
-9	ñ LN190000	β LS610000	Ñ LN200000	´ SD130000	i LI010000	r LR010000	z LZ010000	¾ NF050000	I LI020000	R LR020000	Z LZ020000	9 ND090000
-A	¢ SC040000	! SP020000	¡ SM650000	: SP130000	« SP170000	ª SM210000	ï SP030000	Ý LY120000	(SHY) SP320000	1 ND011000	2 ND021000	3 ND031000
-B	. SP110000	\$ SC030000	, SP080000	# SM010000	» SP180000	º SM200000	¿ SP160000	¨ SD170000	ô LO150000	û LU150000	Ô LO160000	Û LU160000
-C	< SA030000	* SM040000	% SM020000	@ SM050000	ð LD630000	æ LA510000	Ð LD620000	¯ SM150000	ö LO170000	ü LU170000	Ö LO180000	Ü LU180000
-D	( SP060000	) SP070000	— SP090000	´ SP050000	ý LY110000	¸ SD410000	[ SM060000	]	ò LO130000	ù LU130000	Ò LO140000	Ù LU140000
-E	+ SA010000	; SP140000	> SA050000	= SA040000	þ LT630000	Æ LA520000	Þ LT640000	´ SD110000	ó LO110000	ú LU110000	Ó LO120000	Ú LU120000
-F	 SM130000	^ SD150000	? SP150000	" SP040000	± SA020000	Ɔ SC010000	® SM530000	× SA070000	õ LO190000	ÿ LY170000	Õ LO200000	(EO)

Code Page 01047

Figure 274. Coded character set for Latin 1/Open systems

Figure 275 on page 1090 shows the code point mappings for APL code page 293.

HEX DIGITS 1ST → 2ND ↓	4-	5-	6-	7-	8-	9-	A-	B-	C-	D-	E-	F-
-0	(SP) SP010000	& SM030000	- SL690000	◇ SL370000	~ SL460000	□ SL360000	- SL630000	α SL710000	{ SM110000	} SM140000	\ SM070000	0 ND100000
-1	A LA480000	J LJ480000	/ SL760000	^ SL510000	a LA010000	j LJ010000	~ SD190000	ε SL720000	A LA020000	J LJ020000	≡ SL300000	1 ND010000
-2	B LB480000	K LK480000	S LS480000	¨ SL450000	b LB010000	k LK010000	s LS010000	ι SL730000	B LB020000	K LK020000	S LS020000	2 ND020000
-3	C LC480000	L LL480000	T LT480000	⊠ SL270000	c LC010000	l LL010000	t LT010000	ρ SL740000	C LC020000	L LL020000	T LT020000	3 ND030000
-4	D LD480000	M LM480000	U LU480000	ı SL860000	d LD010000	m LM010000	u LU010000	ω SL750000	D LD020000	M LM020000	U LU020000	4 ND040000
-5	E LE480000	N LN480000	V LV480000	€ SL870000	e LE010000	n LN010000	v LV010000		E LE020000	N LN020000	V LV020000	5 ND050000
-6	F LF480000	Q LQ480000	W LW480000	† SL340000	f LF010000	o LO010000	w LW010000	×	F LF020000	Q LQ020000	W LW020000	6 ND060000
-7	G LG480000	P LP480000	X LX480000	‡ SL350000	g LG010000	p LP010000	x LX010000	\	G LG020000	P LP020000	X LX020000	7 ND070000
-8	H LH480000	Q LQ480000	Y LY480000	v SL500000	h LH010000	q LQ010000	y LY010000	÷	H LH020000	Q LQ020000	Y LY020000	8 ND080000
-9	I LI480000	R LR480000	Z LZ480000	` SD130000	i LI010000	r LR010000	z LZ010000		I LI020000	R LR020000	Z LZ020000	9 ND090000
-A	¢ SC040000	! SP020000	ı SM650000	: SL830000	↑ SL610000	▷ SL430000	∩ SL400000	∇ SL030000	♠ SL170000	♣ SL240000	♤ SL150000	
-B	· SL840000	\$ SC030000	‚ SL850000	# SM010000	↓ SL620000	◁ SL420000	∪ SL410000	△ SL060000	♠ SL180000	♣ SL580000	♤ SL160000	♠ SL040000
-C	< SL520000	* SL650000	% SM020000	@ SM050000	≤ SL560000		⊥ SL230000	‡ SL220000	□ SL260000	♠ SL050000	∴ SL320000	△ SL330000
-D	( SL670000	) SL680000	— SL440000	' SL660000	┌ SL010000	○ SL080000	[ SL770000	] SL780000	φ SL090000	♠ SL070000	⊖ SL120000	⊕ SL110000
-E	+ SL790000	; SL800000	> SL530000	= SL810000	└ SL020000		≥ SL570000	≠ SL820000	▣ SL280000	▢ SL130000	⊞ SL140000	⊚ SL190000
-F	 SM130000	┘ SM660000	? SL700000	" SP040000	→ SL600000	← SL590000	◦ SL250000	 SL380000	⊗ SL100000	⊙ SL210000	⊘ SL200000	(EO)

Code Page 00293

Figure 275. Coded character set for APL

---

## Appendix D. Locales supplied with z/OS XL C/C++

The following tables list the compiled locales and locale source files supported by default with the z/OS XL C/C++ product. All of these locale files are provided with the National Language Resources feature of z/OS Language Environment.

### Notes:

1. Prior to z/OS V1R6, the default currency for the European Economic Community was set to local currency in the LC\_MONETARY category of the base locale. If customers wanted to set the Euro as currency, they needed to use `setlocale()` to set the `@euro` locales. Starting with z/OS V1R6, the LC\_MONETARY category in the base locale is now set to use the Euro. Customers who set the base locale, now have the Euro as the default currency. If customers want to use the old (local) currency, they need to issue `setlocale()` to set the `@preeuro` locales.
2. Starting with OS/390 V1R3, the compiled locales are built using the locale source files stored in the CEE.SCEELOCX partitioned data set. The CEE.SCEELOCX locale source files were created in support of the XPG4 standard. The previous locale source files (pre-XPG4) are in the CEE.SCEELOCL partitioned data set. We include the pre-XPG4 source for customers who want to run in a non-POSIX locale environment.
3. In the z/OS UNIX file system, the locale source files are in `/usr/lib/nls/localedef` and the binaries are in `/usr/lib/nls/locale` (we do not ship the pre-XPG4 source or binaries in the z/OS UNIX file system).

---

## Compiled locales

The following table lists each `setlocale()` parameter and its corresponding language, country/territory, codeset, and actual program name. The S370 C, POSIX C and SAA C locales do not have locale modules associated with them. They are built-in locales that cannot be modified, and are always present. Their names cannot be changed. These locales are based on the coded character set IBM-1047. The new versions of the POSIX C and SAA C locales can be provided, but to refer to them, you must specify the full name of the requested locale, including the CodesetRegistry-CodesetEncoding names. For example, the following refers to the SAA C locale built from the coded character set IBM-037:

"SAA.IBM-037"

**Note:** Not all locales listed in Table 362 on page 1092 are fully enabled. The compiler cannot compile source that is coded in `Ja_JP.IBM-290`, `Ja_JP.IBM-930`, `Ja_JP.IBM-1390`, or `Tr_TR.IBM-1026`.

The `<prefix>` in the Load module name column for EBCDIC locales is shown in the following table:

*Table 361. Referencing data types*

EBCDIC locale	Prefix
31-bit	EDC
31-bit XPLINK	CEH
AMODE 64	CEQ

Table 362. Compiled EBCDIC locales supplied with z/OS XL C/C++

Locale name as in setlocale() argument	Language	Country / Territory	Codeset	Load module name
Ar_AA.IBM-425	Arabic	Algeria, Bahrain, Egypt, Iraq, Jordan, Kuwait, Lebanon, Libya, Morocco, Oman, Qatar, Saudi Arabia, Syria, Tunisia, U.A.E., Yemen	IBM-425	<prefix>\$AAAR
Be_BY.IBM-1025	Byelorussian	Belarus	IBM-1025	<prefix>\$BBFE
Be_BY.IBM-1154	Byelorussian	Belarus	IBM-1154	<prefix>\$BBHT
Bg_BG.IBM-1025	Bulgarian	Bulgaria	IBM-1025	<prefix>\$BGFE
Bg_BG.IBM-1153@preeuro	Romanian	Romanian	IBM-1165	<prefix>3ROMB
Bg_BG.IBM-1154	Bulgarian	Bulgaria	IBM-1154	<prefix>\$BGHT
Bg_BG.IBM-1154@euro	Bulgarian	Bulgaria	IBM-1154	<prefix>@BGHT
Bg_BG.IBM-1154@preeuro	Bulgarian	Bulgaria	IBM-1154	<prefix>3BGHT
Bg_BG.IBM-1165@preeuro	Romanian	Romanian	IBM-1165	<prefix>3ROFG
Ca_ES.IBM-924	Catalan	Spain	IBM-924	<prefix>\$CSEZ
Ca_ES.IBM-924@euro	Catalan	Spain	IBM-924	<prefix>@CSEZ
Ca_ES.IBM-924@preeuro	Catalan	Spain	IBM-924	<prefix>3CSEZ
Cs_CZ.IBM-870	Czech	Czech Republic	IBM-870	<prefix>\$CZEQ
Cs_CZ.IBM-1153	Czech	Czech Republic	IBM-1153	<prefix>\$CZMB
Cs_CZ.IBM-1153@euro	Czech	Czech Republic	IBM-1153	<prefix>@CZMB
Cs_CZ.IBM-1153@preeuro	Czech	Czech Republic	IBM-1153	<prefix>3CZMB
Cs_CZ.IBM-1165	Czech	Czech Republic	IBM-1165	<prefix>\$CZFG
Cs_CZ.IBM-1165@euro	Czech	Czech Republic	IBM-1165	<prefix>@CZFG
Cs_CZ.IBM-1165@preeuro	Czech	Czech Republic	IBM-1165	<prefix>3CZFG
Da_DK.IBM-277	Danish	Denmark	IBM-277	<prefix>\$DAEE
Da_DK.IBM-924	Danish	Denmark	IBM-924	<prefix>\$DAEZ
Da_DK.IBM-924@euro	Danish	Denmark	IBM-924	<prefix>@DAEZ
Da_DK.IBM-1047	Danish	Denmark	IBM-1047	<prefix>\$DAEY
Da_DK.IBM-1142	Danish	Denmark	IBM-1142	<prefix>\$DAHE
Da_DK.IBM-1142@euro	Danish	Denmark	IBM-1142	<prefix>@DAHE
De_AT.IBM-924	German	Austria	IBM-924	<prefix>\$DTEZ
De_AT.IBM-924@euro	German	Austria	IBM-924	<prefix>@DTEZ
De_AT.IBM-924@preeuro	German	Austria	IBM-924	<prefix>3DTEZ
De_CH.IBM-500	German	Switzerland	IBM-500	<prefix>\$DCEO
De_CH.IBM-1047	German	Switzerland	IBM-1047	<prefix>\$DCEY
De_CH.IBM-1148	German	Switzerland	IBM-1148	<prefix>\$DCHO
De_CH.IBM-1148@euro	German	Switzerland	IBM-1148	<prefix>@DCHO
De_DE.IBM-273	German	Germany	IBM-273	<prefix>\$DDEB
De_DE.IBM-924	German	Germany	IBM-924	<prefix>\$DDEZ
De_DE.IBM-924@euro	German	Germany	IBM-924	<prefix>@DDEZ
De_DE.IBM-924@preeuro	German	Germany	IBM-924	<prefix>3DDEZ

Table 362. Compiled EBCDIC locales supplied with z/OS XL C/C++ (continued)

Locale name as in setlocale() argument	Language	Country / Territory	Codeset	Load module name
De_DE.IBM-1047	German	Germany	IBM-1047	<prefix>\$DDEY
De_DE.IBM-1141	German	Germany	IBM-1141	<prefix>\$DDHB
De_DE.IBM-1141@euro	German	Germany	IBM-1141	<prefix>@DDHB
De_DE.IBM-1141@preeuro	German	Germany	IBM-1141	<prefix>3DDHB
De_LU.IBM-924	German	Luxembourg	IBM-924	<prefix>\$DLEZ
De_LU.IBM-924@euro	German	Luxembourg	IBM-924	<prefix>@DLEZ
De_LU.IBM-924@preeuro	German	Luxembourg	IBM-924	<prefix>3DLEZ
El_GR.IBM-875	Greek	Greece	IBM-875	<prefix>\$ELES
El_GR.IBM-4971	Greek	Greece	IBM-4971	<prefix>\$ELHS
El_GR.IBM-4971@euro	Greek	Greece	IBM-4971	<prefix>@ELHS
El_GR.IBM-4971@preeuro	Greek	Greece	IBM-4971	<prefix>3ELHS
En_AU.IBM-1047	English	Australia	IBM-1047	<prefix>\$NAEY
En_BE.IBM-924	English	Belgium	IBM-924	<prefix>\$EBEZ
En_BE.IBM-924@euro	English	Belgium	IBM-924	<prefix>@EBEZ
En_BE.IBM-924@preeuro	English	Belgium	IBM-924	<prefix>3EBEZ
En_CA.IBM-037	English	Canada	IBM-037	<prefix>\$ECEA
En_CA.IBM-924	English	Canada	IBM-924	<prefix>\$ECEZ
En_CA.IBM-1047	English	Canada	IBM-1047	<prefix>\$ECEY
En_CA.IBM-1140	English	Canada	IBM-1140	<prefix>\$ECHA
En_GB.IBM-285	English	United Kingdom	IBM-285	<prefix>\$EKEK
En_GB.IBM-924	English	Great Britain	IBM-924	<prefix>\$EKEZ
En_GB.IBM-924@euro	English	Great Britain	IBM-924	<prefix>@EKEZ
En_GB.IBM-1047	English	United Kingdom	IBM-1047	<prefix>\$EKEY
En_GB.IBM-1146	English	United Kingdom	IBM-1146	<prefix>\$EKHK
En_GB.IBM-1146@euro	English	United Kingdom	IBM-1146	<prefix>@EKHK
En_HK.IBM-1047	English	China (Hong Kong S.A.R. of China)	IBM-1047	<prefix>\$NHEY
En_IE.IBM-924	English	Ireland	IBM-924	<prefix>\$EIEZ
En_IE.IBM-924@euro	English	Ireland	IBM-924	<prefix>@EIEZ
En_IE.IBM-924@preeuro	English	Ireland	IBM-924	<prefix>3EIEZ
En_IN.IBM-1047	English	India	IBM-1047	<prefix>\$NIEY
En_JP.IBM-1027	English	Japan	IBM-1027	<prefix>\$EJEX
En_JP.IBM-5123	English	Japan	IBM-5123	<prefix>\$EJHX
En_NZ.IBM-1047	English	New Zealand	IBM-1047	<prefix>\$NZEY
En_PH.IBM-1047	English	Philippines	IBM-1047	<prefix>\$NPEY
En_SG.IBM-1047	English	Singapore	IBM-1047	<prefix>\$NSEY
En_US.IBM-037	English	United States	IBM-037	<prefix>\$EUEA
En_US.IBM-1047	English	United States	IBM-1047	<prefix>\$EUEY
En_US.IBM-1140	English	United States	IBM-1140	<prefix>\$EUHA



Table 362. Compiled EBCDIC locales supplied with z/OS XL C/C++ (continued)

Locale name as in setlocale() argument	Language	Country / Territory	Codeset	Load module name
En_US.IBM-1140@euro	English	United States	IBM-1140	<prefix>@EUHA
En_ZA.IBM-037	English	South Africa	IBM-37	<prefix>\$EZEZ
En_ZA.IBM-924	English	South Africa	IBM-924	<prefix>\$EZEZ
En_ZA.IBM-1047	English	South Africa	IBM-1047	<prefix>\$EZEY
En_ZA.IBM-1140	English	South Africa	IBM-1140	<prefix>\$EZHA
Es_AR.IBM-284	Spanish	Argentina	IBM-284	<prefix>\$EAEJ
Es_AR.IBM-924	Spanish	Argentina	IBM-924	<prefix>\$EAEZ
Es_AR.IBM-1047	Spanish	Argentina	IBM-1047	<prefix>\$EAEY
Es_AR.IBM-1145	Spanish	Argentina	IBM-1145	<prefix>\$EAHJ
Es_BO.IBM-284	Spanish	Bolivia	IBM-284	<prefix>\$EOEJ
Es_BO.IBM-924	Spanish	Bolivia	IBM-924	<prefix>\$EOEZ
Es_BO.IBM-1047	Spanish	Bolivia	IBM-1047	<prefix>\$EOEY
Es_BO.IBM-1145	Spanish	Bolivia	IBM-1145	<prefix>\$EOHJ
Es_CL.IBM-284	Spanish	Chile	IBM-284	<prefix>\$EHEJ
Es_CL.IBM-924	Spanish	Chile	IBM-924	<prefix>\$EHEZ
Es_CL.IBM-1047	Spanish	Chile	IBM-1047	<prefix>\$EHEY
Es_CL.IBM-1145	Spanish	Chile	IBM-1145	<prefix>\$EHHJ
Es_CO.IBM-284	Spanish	Colombia	IBM-284	<prefix>\$FGEJ
Es_CO.IBM-924	Spanish	Colombia	IBM-924	<prefix>\$FGEZ
Es_CO.IBM-1047	Spanish	Colombia	IBM-1047	<prefix>\$FGEY
Es_CO.IBM-1145	Spanish	Colombia	IBM-1145	<prefix>\$FGHJ
Es_CR.IBM-284	Spanish	Costa Rica	IBM-284	<prefix>\$EREJ
Es_CR.IBM-924	Spanish	Costa Rica	IBM-924	<prefix>\$EREZ
Es_CR.IBM-1047	Spanish	Costa Rica	IBM-1047	<prefix>\$EREY
Es_CR.IBM-1145	Spanish	Costa Rica	IBM-1145	<prefix>\$ERHJ
Es_DO.IBM-284	Spanish	Dominican Republic	IBM-284	<prefix>\$EDEJ
Es_DO.IBM-924	Spanish	Dominican Republic	IBM-924	<prefix>\$EDEZ
Es_DO.IBM-1047	Spanish	Dominican Republic	IBM-1047	<prefix>\$EDEY
Es_DO.IBM-1145	Spanish	Dominican Republic	IBM-1145	<prefix>\$EDHJ
Es_EC.IBM-284	Spanish	Ecuador	IBM-284	<prefix>\$EQEJ
Es_EC.IBM-924	Spanish	Ecuador	IBM-924	<prefix>\$EQEZ
Es_EC.IBM-1047	Spanish	Ecuador	IBM-1047	<prefix>\$EQEY
Es_EC.IBM-1145	Spanish	Ecuador	IBM-1145	<prefix>\$EQHJ
Es_ES.IBM-284	Spanish	Spain	IBM-284	<prefix>\$ESEJ
Es_ES.IBM-924	Spanish	Spain	IBM-924	<prefix>\$ESEZ
Es_ES.IBM-924@euro	Spanish	Spain	IBM-924	<prefix>@ESEZ
Es_ES.IBM-924@preeuro	Spanish	Spain	IBM-924	<prefix>3ESEZ
Es_ES.IBM-1047	Spanish	Spain	IBM-1047	<prefix>\$ESEY
Es_ES.IBM-1145	Spanish	Spain	IBM-1145	<prefix>\$ESHJ

Table 362. Compiled EBCDIC locales supplied with z/OS XL C/C++ (continued)

Locale name as in setlocale() argument	Language	Country / Territory	Codeset	Load module name
Es_ES.IBM-1145@euro	Spanish	Spain	IBM-1145	<prefix>@ESHJ
Es_ES.IBM-1145@preeuro	Spanish	Spain	IBM-1145	<prefix>3ESHJ
Es_GT.IBM-284	Spanish	Guatemala	IBM-284	<prefix>\$EGEJ
Es_GT.IBM-924	Spanish	Guatemala	IBM-924	<prefix>\$EGEZ
Es_GT.IBM-1047	Spanish	Guatemala	IBM-1047	<prefix>\$EGEY
Es_GT.IBM-1145	Spanish	Guatemala	IBM-1145	<prefix>\$EGHJ
Es_HN.IBM-284	Spanish	Honduras	IBM-284	<prefix>\$FEEJ
Es_HN.IBM-924	Spanish	Honduras	IBM-924	<prefix>\$FEEZ
Es_HN.IBM-1047	Spanish	Honduras	IBM-1047	<prefix>\$FEEY
Es_HN.IBM-1145	Spanish	Honduras	IBM-1145	<prefix>\$FEHJ
Es_MX.IBM-284	Spanish	Mexico	IBM-284	<prefix>\$EMEJ
Es_MX.IBM-924	Spanish	Mexico	IBM-924	<prefix>\$EMEZ
Es_MX.IBM-1047	Spanish	Mexico	IBM-1047	<prefix>\$EMEY
Es_MX.IBM-1145	Spanish	Mexico	IBM-1145	<prefix>\$EMHJ
Es_NI.IBM-284	Spanish	Nicaragua	IBM-284	<prefix>\$FAEJ
Es_NI.IBM-924	Spanish	Nicaragua	IBM-924	<prefix>\$FAEZ
Es_NI.IBM-1047	Spanish	Nicaragua	IBM-1047	<prefix>\$FAEY
Es_NI.IBM-1145	Spanish	Nicaragua	IBM-1145	<prefix>\$FAHJ
Es_PA.IBM-284	Spanish	Panama	IBM-284	<prefix>\$EPEJ
Es_PA.IBM-924	Spanish	Panama	IBM-924	<prefix>\$EPEZ
Es_PA.IBM-1047	Spanish	Panama	IBM-1047	<prefix>\$EPEY
Es_PA.IBM-1145	Spanish	Panama	IBM-1145	<prefix>\$EPHJ
Es_PE.IBM-284	Spanish	Peru	IBM-284	<prefix>\$EWEJ
Es_PE.IBM-924	Spanish	Peru	IBM-924	<prefix>\$EWEZ
Es_PE.IBM-1047	Spanish	Peru	IBM-1047	<prefix>\$EWEY
Es_PE.IBM-1145	Spanish	Peru	IBM-1145	<prefix>\$EWHJ
Es_PR.IBM-284	Spanish	Puerto Rico	IBM-284	<prefix>\$EXEJ
Es_PR.IBM-924	Spanish	Puerto Rico	IBM-924	<prefix>\$EXEZ
Es_PR.IBM-1047	Spanish	Puerto Rico	IBM-1047	<prefix>\$EXEY
Es_PR.IBM-1145	Spanish	Puerto Rico	IBM-1145	<prefix>\$EXHJ
Es_PY.IBM-284	Spanish	Paraguay	IBM-284	<prefix>\$EYEJ
Es_PY.IBM-924	Spanish	Paraguay	IBM-924	<prefix>\$EYEZ
Es_PY.IBM-1047	Spanish	Paraguay	IBM-1047	<prefix>\$EY EY
Es_PY.IBM-1145	Spanish	Paraguay	IBM-1145	<prefix>\$EYHJ
Es_SV.IBM-284	Spanish	El Salvador	IBM-284	<prefix>\$EVEJ
Es_SV.IBM-924	Spanish	El Salvador	IBM-924	<prefix>\$EVEZ
Es_SV.IBM-1047	Spanish	El Salvador	IBM-1047	<prefix>\$EVEY
Es_SV.IBM-1145	Spanish	El Salvador	IBM-1145	<prefix>\$EVHJ
Es_US.IBM-284	Spanish	United States	IBM-284	<prefix>\$ETEJ

Table 362. Compiled EBCDIC locales supplied with z/OS XL C/C++ (continued)

Locale name as in setlocale() argument	Language	Country / Territory	Codeset	Load module name
Es_US.IBM-924	Spanish	United States	IBM-924	<prefix>\$ETEZ
Es_US.IBM-1047	Spanish	United States	IBM-1047	<prefix>\$ET EY
Es_US.IBM-1145	Spanish	United States	IBM-1145	<prefix>\$ETHJ
Es_UY.IBM-284	Spanish	Uruguay	IBM-284	<prefix>\$FDEJ
Es_UY.IBM-924	Spanish	Uruguay	IBM-924	<prefix>\$DFDF
Es_UY.IBM-1047	Spanish	Uruguay	IBM-1047	<prefix>\$FDEY
Es_UY.IBM-1145	Spanish	Uruguay	IBM-1145	<prefix>\$FDHJ
Es_VE.IBM-284	Spanish	Venezuela	IBM-284	<prefix>\$EFEJ
Es_VE.IBM-924	Spanish	Venezuela	IBM-924	<prefix>\$EFEZ
Es_VE.IBM-1047	Spanish	Venezuela	IBM-1047	<prefix>\$EFEY
Es_VE.IBM-1145	Spanish	Venezuela	IBM-1145	<prefix>\$EFHJ
Es_VEO.IBM-284	Spanish	Venezuela	IBM-284	<prefix>\$VOEJ
Es_VEO.IBM-924	Spanish	Venezuela	IBM-924	<prefix>\$VOEZ
Es_VEO.IBM-1047	Spanish	Venezuela	IBM-1047	<prefix>\$VOEY
Es_VEO.IBM-1145	Spanish	Venezuela	IBM-1145	<prefix>\$VOHJ
Et_EE.IBM-1122	Estonian	Estonia	IBM-1122	<prefix>\$EEFD
Et_EE.IBM-1157	Estonian	Estonia	IBM-1157	<prefix>\$EEHD
Et_EE.IBM-1157@euro	Estonian	Estonia	IBM-1157	<prefix>@EEHD
Et_EE.IBM-1157@preeuro	Estonian	Estonia	IBM-1157	<prefix>3EEHD
Fi_FL.IBM-278	Finnish	Finland	IBM-278	<prefix>\$FIEF
Fi_FL.IBM-924	Finnish	Finland	IBM-924	<prefix>\$FIEZ
Fi_FL.IBM-924@euro	Finnish	Finland	IBM-924	<prefix>@FIEZ
Fi_FL.IBM-924@preeuro	Finnish	Finland	IBM-924	<prefix>3FIEZ
Fi_FL.IBM-1047	Finnish	Finland	IBM-1047	<prefix>\$FIEY
Fi_FL.IBM-1143	Finnish	Finland	IBM-1143	<prefix>\$FIHF
Fi_FL.IBM-1143@euro	Finnish	Finland	IBM-1143	<prefix>@FIHF
Fi_FL.IBM-1143@preeuro	Finnish	Finland	IBM-1143	<prefix>3FIHF
Fr_BE.IBM-500	French	Belgium	IBM-500	<prefix>\$FBEO
Fr_BE.IBM-924	French	Belgium	IBM-924	<prefix>\$FBEZ
Fr_BE.IBM-924@euro	French	Belgium	IBM-924	<prefix>@FBEZ
Fr_BE.IBM-924@preeuro	French	Belgium	IBM-924	<prefix>3FBEZ
Fr_BE.IBM-1047	French	Belgium	IBM-1047	<prefix>\$FB EY
Fr_BE.IBM-1148	French	Belgium	IBM-1148	<prefix>\$FBHO
Fr_BE.IBM-1148@euro	French	Belgium	IBM-1148	<prefix>@FBHO
Fr_BE.IBM-1148@preeuro	French	Belgium	IBM-1148	<prefix>3FBHO
Fr_CA.IBM-037	French	Canada	IBM-037	<prefix>\$FCEA
Fr_CA.IBM-500	French	Canada	IBM-500	<prefix>\$FCEO
Fr_CA.IBM-1047	French	Canada	IBM-1047	<prefix>\$FCEY
Fr_CA.IBM-1140	French	Canada	IBM-1140	<prefix>\$FCHA

Table 362. Compiled EBCDIC locales supplied with z/OS XL C/C++ (continued)

Locale name as in setlocale() argument	Language	Country / Territory	Codeset	Load module name
Fr_CA.IBM-1140@euro	French	Canada	IBM-1140	<prefix>@FCHA
Fr_CH.IBM-500	French	Switzerland	IBM-500	<prefix>\$FSEO
Fr_CH.IBM-1047	French	Switzerland	IBM-1047	<prefix>\$FSEY
Fr_CH.IBM-1148	French	Switzerland	IBM-1148	<prefix>\$FSHO
Fr_CH.IBM-1148@euro	French	Switzerland	IBM-1148	<prefix>@FSHO
Fr_FR.IBM-297	French	France	IBM-297	<prefix>\$FFEM
Fr_FR.IBM-924	French	France	IBM-924	<prefix>\$FFEZ
Fr_FR.IBM-924@euro	French	France	IBM-924	<prefix>@FFEZ
Fr_FR.IBM-924@preeuro	French	France	IBM-924	<prefix>3FFEZ
Fr_FR.IBM-1047	French	France	IBM-1047	<prefix>\$FFEY
Fr.FR.IBM-1147	French	France	IBM-1147	<prefix>\$FFHM
Fr.FR.IBM-1147@euro	French	France	IBM-1147	<prefix>@FFHM
Fr_FR.IBM-1147@preeuro	French	France	IBM-1147	<prefix>3FFHM
Fr_LU.IBM-924	French	Luxembourg	IBM-924	<prefix>\$FLEZ
Fr_LU.IBM-924@euro	French	Luxembourg	IBM-924	<prefix>@FLEZ
Fr_LU.IBM-924@preeuro	French	Luxembourg	IBM-924	<prefix>3FLEZ
Hr_HR.IBM-870	Croatian	Croatia	IBM-870	<prefix>\$HREQ
Hr_HR.IBM-1153	Croatian	Croatia	IBM-1153	<prefix>\$HRMB
Hr_HR.IBM-1165	Croatian	Croatia	IBM-1165	<prefix>\$HRFG
Hu_HU.IBM-870	Hungarian	Hungary	IBM-870	<prefix>\$HUEQ
Hu_HU.IBM-1153	Hungarian	Hungary	IBM-1153	<prefix>\$HUMB
Hu_HU.IBM-1153@euro	Hungarian	Hungary	IBM-1153	<prefix>@HUMB
Hu_HU.IBM-1153@preeuro	Hungarian	Hungary	IBM-1153	<prefix>3HUMB
Hu_HU.IBM-1165	Hungarian	Hungary	IBM-1165	<prefix>\$HUFG
Hu_HU.IBM-1165@euro	Hungarian	Hungary	IBM-1165	<prefix>@HUFG
Hu_HU.IBM-1165@preeuro	Hungarian	Hungary	IBM-1165	<prefix>3HUFG
Id_ID.IBM-1047	Indonesian	Indonesia	IBM-1047	<prefix>\$IIEY
Is_IS.IBM-871	Icelandic	Iceland	IBM-871	<prefix>\$ISER
Is_IS.IBM-1047	Icelandic	Iceland	IBM-1047	<prefix>\$ISEY
Is_IS.IBM-1149	Icelandic	Iceland	IBM-1149	<prefix>\$ISHR
Is_IS.IBM-1149@euro	Icelandic	Iceland	IBM-1149	<prefix>@ISHR
It_CH.IBM-500	Italian	Switzerland	IBM-500	<prefix>\$ICEO
It_CH.IBM-924	Italian	Switzerland	IBM-924	<prefix>\$ICEZ
It_CH.IBM-1047	Italian	Switzerland	IBM-1047	<prefix>\$ICEY
It_CH.IBM-1148	Italian	Switzerland	IBM-1148	<prefix>\$ICHO
It_IT.IBM-280	Italian	Italy	IBM-280	<prefix>\$ITEG
It_IT.IBM-924	Italian	Italy	IBM-924	<prefix>\$ITEZ
It_IT.IBM-924@euro	Italian	Italy	IBM-924	<prefix>@ITEZ
It_IT.IBM-924@preeuro	Italian	Italy	IBM-924	<prefix>3ITEZ

Table 362. Compiled EBCDIC locales supplied with z/OS XL C/C++ (continued)

Locale name as in setlocale() argument	Language	Country / Territory	Codeset	Load module name
It_IT.IBM-1047	Italian	Italy	IBM-1047	<prefix>\$ITEY
It_IT.IBM-1144	Italian	Italy	IBM-1144	<prefix>\$ITHG
It_IT.IBM-1144@euro	Italian	Italy	IBM-1144	<prefix>@ITHG
It_IT.IBM-1144@preeuro	Italian	Italy	IBM-1144	<prefix>3ITHG
Iw_IL.IBM-424	Hebrew	Israel	IBM-424	<prefix>\$ILFB
Iw_IL.IBM-12712	Hebrew	Israel	IBM12712	<prefix>\$ILHH
Ja_JP.IBM-290	Japanese	Japan	IBM-290	<prefix>\$JAEL
Ja_JP.IBM-930	Japanese	Japan	IBM-930	<prefix>\$JAEU
Ja_JP.IBM-939	Japanese	Japan	IBM-939	<prefix>\$JAEV
Ja_JP.IBM-1027	Japanese	Japan	IBM-1027	<prefix>\$JAEX
Ja_JP.IBM-1390	Japanese	Japan	IBM-1390	<prefix>\$JAHU
Ja_JP.IBM-1399	Japanese	Japan	IBM-1399	<prefix>\$JAHV
Ja_JP.IBM-5123	Japanese	Japan	IBM-5123	<prefix>\$JAHX
Ja_JP.IBM-8482	Japanese	Japan	IBM-8482	<prefix>\$J AHL
Ko_KR.IBM-933	Korean	Korea	IBM-933	<prefix>\$KRGZ
Ko_KR.IBM-1364	Korean	Korea	IBM-1364	<prefix>\$K RKZ
Lt_LT.IBM-1112	Lithuanian	Lithuania	IBM-1112	<prefix>\$LTGD
Lt_LT.IBM-1156	Lithuanian	Lithuania	IBM-1156	<prefix>\$LTHZ
Lt_LT.IBM-1156@euro	Lithuanian	Lithuania	IBM-1156	<prefix>@LTHZ
Lt_LT.IBM-1156@preeuro	Lithuanian	Lithuania	IBM-1156	<prefix>3LTHZ
Lv_LV.IBM-1112	Latvian	Latvia	IBM-1112	<prefix>\$LLGD
Lv_LV.IBM-1156	Latvian	Latvia	IBM-1156	<prefix>\$LLHZ
Lv_LV.IBM-1156@euro	Latvian	Latvia	IBM-1156	<prefix>@LLHZ
Lv_LV.IBM-1156@preeuro	Latvian	Latvia	IBM-1156	<prefix>3LLHZ
Mk_MK.IBM-1025	Macedonian	Macedonia	IBM-1025	<prefix>\$MMFE
Mk_MK.IBM-1154	Macedonian	Macedonia	IBM-1154	<prefix>\$MMHT
Ms_MY.IBM-1047	Malay	Malaysia	IBM-1047	<prefix>\$MYEY
Nl_BE.IBM-500	Dutch	Belgium	IBM-500	<prefix>\$NBEO
Nl_BE.IBM-924	Dutch	Belgium	IBM-924	<prefix>\$NBEZ
Nl_BE.IBM-924@euro	Dutch	Belgium	IBM-924	<prefix>@NBEZ
Nl_BE.IBM-924@preeuro	Dutch	Belgium	IBM-924	<prefix>3NBEZ
Nl_BE.IBM-1047	Dutch	Belgium	IBM-1047	<prefix>\$NBEY
Nl_BE.IBM-1148	Dutch	Belgium	IBM-1148	<prefix>\$NBHO
Nl_BE.IBM-1148@euro	Dutch	Belgium	IBM-1148	<prefix>@NBHO
Nl_BE.IBM-1148@preeuro	Dutch	Belgium	IBM-1148	<prefix>3NBHO
Nl_NL.IBM-037	Dutch	Netherlands	IBM-037	<prefix>\$NNEA
Nl_NL.IBM-924	Dutch	Netherlands	IBM-924	<prefix>\$NNEZ
Nl_NL.IBM-924@euro	Dutch	Netherlands	IBM-924	<prefix>@NNEZ
Nl_NL.IBM-924@preeuro	Dutch	Netherlands	IBM-924	<prefix>3NNEZ

Table 362. Compiled EBCDIC locales supplied with z/OS XL C/C++ (continued)

Locale name as in setlocale() argument	Language	Country / Territory	Codeset	Load module name
NL_NL.IBM-1047	Dutch	Netherlands	IBM-1047	<prefix>\$NNEY
NL_NL.IBM-1140	Dutch	Netherlands	IBM-1140	<prefix>\$NNHA
NL_NL.IBM-1140@euro	Dutch	Netherlands	IBM-1140	<prefix>@NNHA
NL_NL.IBM-1140@preeuro	Dutch	Netherlands	IBM-1140	<prefix>3NNHA
No_NO.IBM-277	Norwegian	Norway	IBM-277	<prefix>\$NOEE
No_NO.IBM-1047	Norwegian	Norway	IBM-1047	<prefix>\$NOEY
No_NO.IBM-1142	Norwegian	Norway	IBM-1142	<prefix>\$NOHE
No_NO.IBM-1142@euro	Norwegian	Norway	IBM-1142	<prefix>@NOHE
Pl_PL.IBM-870	Polish	Poland	IBM-870	<prefix>\$PLEQ
Pl_PL.IBM-1153	Polish	Poland	IBM-1153	<prefix>\$PLMB
Pl_PL.IBM-1153@euro	Polish	Poland	IBM-1153	<prefix>@PLMB
Pl_PL.IBM-1153@preeuro	Polish	Poland	IBM-1153	<prefix>3PLMB
Pl_PL.IBM-1165	Polish	Poland	IBM-1165	<prefix>\$PLFG
Pl_PL.IBM-1165@euro	Polish	Poland	IBM-1165	<prefix>@PLFG
Pl_PL.IBM-1165@preeuro	Polish	Poland	IBM-1165	<prefix>3PLFG
Pt_BR.IBM-037	Portuguese	Brazil	IBM-037	<prefix>\$BREA
Pt_BR.IBM-1047	Portuguese	Brazil	IBM-1047	<prefix>\$BREY
Pt_BR.IBM-1140	Portuguese	Brazil	IBM-1140	<prefix>\$BRHA
Pt_BR.IBM-1140@euro	Portuguese	Brazil	IBM-1140	<prefix>@BRHA
Pt_PT.IBM-037	Portuguese	Portugal	IBM-037	<prefix>\$PTEA
Pt_PT.IBM-924	Portuguese	Portugal	IBM-924	<prefix>\$PTEZ
Pt_PT.IBM-924@euro	Portuguese	Portugal	IBM-924	<prefix>@PTEZ
Pt_PT.IBM-924@preeuro	Portuguese	Portugal	IBM-924	<prefix>3PTEZ
Pt_PT.IBM-1047	Portuguese	Portugal	IBM-1047	<prefix>\$PTEY
Pt_PT.IBM-1140	Portuguese	Portugal	IBM-1140	<prefix>\$PTHA
Pt_PT.IBM-1140@euro	Portuguese	Portugal	IBM-1140	<prefix>@PTHA
Pt_PT.IBM-1140@preeuro	Portuguese	Portugal	IBM-1140	<prefix>3PTHA
Ro_RO.IBM-870	Romanian	Romania	IBM-870	<prefix>\$ROEQ
Ro_RO.IBM-1153@euro	Romanian	Romanian	IBM-1153	<prefix>@ROMB
Ro_RO.IBM-1153	Romanian	Romania	IBM-1153	<prefix>\$ROMB
Ro_RO.IBM-1165	Romanian	Romania	IBM-1165	<prefix>\$ROFG
Ro_RO.IBM-1165@euro	Romanian	Romanian	IBM-1165	<prefix>@ROFG
Ru_RU.IBM-1025	Russian	Russia	IBM-1025	<prefix>\$RUFE
Ru_RU.IBM-1154	Russian	Russia	IBM-1154	<prefix>\$RUHT
Sh_SP.IBM-870	Serbian (Latin)	Serbia	IBM-870	<prefix>\$SLEQ
Sh_SP.IBM-1153	Serbian (Latin)	Serbia	IBM-1153	<prefix>\$SLMB
Sh_SP.IBM-1165	Serbian (Latin)	Serbia	IBM-1165	<prefix>\$SLFG
Sk_SK.IBM-870	Slovak	Slovakia	IBM-870	<prefix>\$SKEQ
Sk_SK.IBM-1153	Slovak	Slovakia	IBM-1153	<prefix>\$SKMB



Table 362. Compiled EBCDIC locales supplied with z/OS XL C/C++ (continued)

Locale name as in setlocale() argument	Language	Country / Territory	Codeset	Load module name
Sk_SK.IBM-1153@euro	Slovak	Slovakia	IBM-1153	<prefix>@SKMB
Sk_SK.IBM-1153@preeuro	Slovak	Slovakia	IBM-1153	<prefix>3SKMB
Sk_SK.IBM-1165	Slovak	Slovakia	IBM-1165	<prefix>\$SKFG
Sk_SK.IBM-1165@euro	Slovak	Slovakia	IBM-1165	<prefix>@SKFG
Sk_SK.IBM-1165@preeuro	Slovak	Slovakia	IBM-1165	<prefix>3SKFG
Sl_SI.IBM-870	Slovene	Slovenia	IBM-870	<prefix>\$SIEQ
Sl_SI.IBM-1153	Slovene	Slovenia	IBM-1153	<prefix>\$SIMB
Sl_SI.IBM-1153@euro	Slovene	Slovenia	IBM-1153	<prefix>@SIMB
Sl_SI.IBM-1153@preeuro	Slovene	Slovenia	IBM-1153	<prefix>3SIMB
Sl_SI.IBM-1165	Slovene	Slovenia	IBM-1165	<prefix>\$SIFG
Sl_SI.IBM-1165@euro	Slovene	Slovenia	IBM-1165	<prefix>@SIFG
Sl_SI.IBM-1165@preeuro	Slovene	Slovenia	IBM-1165	<prefix>3SIFG
Sq_AL.IBM-500	Albanian	Albania	IBM-500	<prefix>\$SAEO
Sq_AL.IBM-1047	Albanian	Albania	IBM-1047	<prefix>\$SAEY
Sq_AL.IBM-1148	Albanian	Albania	IBM-1148	<prefix>\$SAHO
Sq_AL.IBM-1148@euro	Albanian	Albania	IBM-1148	<prefix>@SAHO
Sr_SP.IBM-1025	Serbian (Cyrillic)	Serbia	IBM-1025	<prefix>\$SCFE
Sr_SP.IBM-1154	Serbian (Cyrillic)	Serbia	IBM-1154	<prefix>\$SCHT
Sv_SE.IBM-278	Swedish	Sweden	IBM-278	<prefix>\$SVEF
Sv_SE.IBM-924	Swedish	Sweden	IBM-924	<prefix>\$SVEZ
Sv_SE.IBM-924@euro	Swedish	Sweden	IBM-924	<prefix>@SVEZ
Sv_SE.IBM-924@preeuro	Swedish	Sweden	IBM-924	<prefix>3SVEZ
Sv_SE.IBM-1047	Swedish	Sweden	IBM-1047	<prefix>\$SVEY
Sv_SE.IBM-1143	Swedish	Sweden	IBM-1143	<prefix>\$SVHF
Sv_SE.IBM-1143@euro	Swedish	Sweden	IBM-1143	<prefix>@SVHF
Sv_SE.IBM-1143@preeuro	Swedish	Sweden	IBM-1143	<prefix>3SVHF
th_TH.IBM-838	Thai	Thailand	IBM-838	<prefix>\$THEP
th_TH.IBM-1160	Thai	Thailand	IBM-1160	<prefix>\$THHP
Tr_TR.IBM-1026	Turkish	Turkey	IBM-1026	<prefix>\$TREW
Tr_TR.IBM-1155	Turkish	Turkey	IBM-1155	<prefix>\$TRHW
Uk_UA.IBM-1123	Ukrainian	Ukraine	IBM-1123	<prefix>\$UUFH
Uk_UA.IBM-1158	Ukrainian	Ukraine	IBM-1158	<prefix>\$UUFI
Zh_CN.IBM-935	Simplified Chinese	China (PRC)	IBM-935	<prefix>\$ZCGY
Zh_CN.IBM-1388	Simplified Chinese	China (PRC)	IBM-1388	<prefix>\$ZCGV
Zh_HKS.IBM-935	Simplified Chinese	China (Hong Kong S.A.R. of China)	IBM-935	<prefix>\$ZGGY

Table 362. Compiled EBCDIC locales supplied with z/OS XL C/C++ (continued)

Locale name as in setlocale() argument	Language	Country / Territory	Codeset	Load module name
Zh_HKS.IBM-1388	Simplified Chinese	China (Hong Kong S.A.R. of China)	IBM-1388	<prefix>\$ZGGV
Zh_SGS.IBM-935	Simplified Chinese	Singapore	IBM-935	<prefix>\$ZSGY
Zh_SGS.IBM-1388	Simplified Chinese	Singapore	IBM-1388	<prefix>\$ZSGV
Zh_TW.IBM-937	Traditional Chinese	Taiwan	IBM-937	<prefix>\$ZTGW
Zh_TW.IBM-1371	Traditional Chinese	Taiwan	IBM-1371	<prefix>\$ZTKA

Table 363. Compiled ASCII locales supplied with z/OS XL C/C++

Locale name as in setlocale() argument	Language	Country / Territory	Codeset	Load module name
af_ZA.UTF-8	South African Afrikaans	South Africa	UTF-8	CEJ\$AFF8
az_AZ.UTF-8	Azerbaijani-Latin	Azerbaijan	UTF-8	CEJ\$AZF8
be_BY.ISO8859-5	Byelorussian	Belarus	ISO8859-5	CEJ\$BBI5
bg_BG.UTF-8	Bulgarian	Bulgaria	UTF-8	CEJ\$BGF8
bn_IN.UTF-8	Bengali	India	UTF-8	CEJ\$BNF8
ca_ES.UTF-8	Catalan	Spain	UTF-8	CEJ\$CSF8
ca_ES.UTF-8@euro	Catalan	Spain (euro)	UTF-8	CEJ@CSF8
ca_ES.UTF-8@preeuro	Catalan	Spain (preeuro)	UTF-8	CEJ3CSF8
cs_CZ.ISO8859-2	Czech	Czech Republic	ISO8859-2	CEJ\$CZI2
cs_CZ.UTF-8	Czech	Czech Republic	UTF-8	CEJ\$CZF8
cs_CZ.UTF-8@euro	Czech	Czech Republic (euro)	UTF-8	CEJ@CZF8
cs_CZ.UTF-8@preeuro	Czech	Czech Republic (preeuro) Link to base	UTF-8	CEJ3CZF8
cy_GB.UTF-8	Welsh	Great Britain	UTF-8	CEJ\$CYF8
cy_GB.UTF-8@euro	Welsh	Great Britain (euro)	UTF-8	CEJ@CYF8
da_DK.ISO8859-1	Danish	Denmark	ISO8859-1	CEJ\$DAI1
da_DK.UTF-8	Danish	Denmark	UTF-8	CEJ\$DAF8
da_DK.UTF-8@euro	Danish	Denmark (euro)	UTF-8	CEJ@DAF8
de_AT.UTF-8	German	Austria	UTF-8	CEJ\$DTF8
de_AT.UTF-8@euro	German	Austria (euro) Link to base	UTF-8	CEJ@DTF8
de_AT.UTF-8@preeuro	German	Austria (preeuro)	UTF-8	CEJ3DTF8
de_CH.ISO8859-1	German	Switzerland	ISO8859-1	CEJ\$DCI1
de_CH.UTF-8	German	Switzerland	UTF-8	CEJ\$DCF8
de_DE.ISO8859-1	German	Germany	ISO8859-1	CEJ\$DDI1
de_DE.UTF-8	German	Germany	UTF-8	CEJ\$DDF8



Table 363. Compiled ASCII locales supplied with z/OS XL C/C++ (continued)

Locale name as in setlocale() argument	Language	Country / Territory	Codeset	Load module name
de_DE.UTF-8@euro	German	Germany (euro) Link to base	UTF-8	CEJ3DDF8
de_DE.UTF-8@preeuro	German	Germany (preeuro)	UTF-8	CEJ3DDF8
de_LU.UTF-8	German	Luxembourg	UTF-8	CEJ\$DLF8
de_LU.UTF-8@euro	German	Luxembourg (euro) Link to base	UTF-8	CEJ@DLF8
de_LU.UTF-8@preeuro	German	Luxembourg (preeuro)	UTF-8	CEJ3DLF8
el_GR.ISO8859-7	Greek	Greece	ISO8859-7	CEJ\$ELI7
el_GR.UTF-8	Greek	Greece	UTF-8	CEJ\$ELF8
el_GR.UTF-8@euro	Greek	Greece (euro) Link to base	UTF-8	CEJ@ELF8
el_GR.UTF-8@preeuro	Greek	Greece (preeuro)	UTF-8	CEJ3ELF8
en_AU.ISO8859-1	English	Australia	ISO8859-1	CEJ\$NAI1
en_BE.UTF-8	English	Belgium	UTF-8	CEJ\$EBF8
en_BE.UTF-8@euro	English	Belgium (euro) Link to base	UTF-8	CEJ@EBF8
en_BE.UTF-8@preeuro	English	Belgium (preeuro)	UTF-8	CEJ3EBF8
en_CA.ISO8859-1	English	Canada	ISO8859-1	CEJ\$ECI1
en_CA.ISO8859-15	English	Canada	ISO8859-15	CEJ\$ECIF
en_GB.ISO8859-1	English	United Kingdom	ISO8859-1	CEJ\$EKI1
en_GB.UTF-8	English	United Kingdom	UTF-8	CEJ\$EKF8
en_GB.UTF-8@euro	English	Great Britain (euro)	UTF-8	CEJ@EKF8
en_HK.ISO8859-1	English	China (Hong Kong S.A.R. of China)	ISO8859-1	CEJ\$NHI1
en_IE.UTF-8	English	Ireland	UTF-8	CEJ\$EIF8
en_IE.UTF-8@euro	English	Ireland (euro) Link to base	UTF-8	CEJ@EIF8
en_IE.UTF-8@preeuro	English	Ireland (preeuro)	UTF-8	CEJ3EIF8
en_IN.ISO8859-1	English	India	ISO8859-1	CEJ\$NII1
en_NZ.ISO8859-1	English	New Zealand	ISO8859-1	CEJ\$NZI1
en_PH.ISO8859-1	English	Philippines	ISO8859-1	CEJ\$NPI1
en_SG.ISO8859-1	English	Singapore	ISO8859-1	CEJ\$NSI1
en_US.ISO8859-1	English	United States	ISO8859-1	CEJ\$EUI1
en_US.UTF-8	English	United States	UTF-8	CEJ\$EUF8
es_ES.ISO8859-1	Spanish	Spain	ISO8859-1	CEJ\$ESI1
es_ES.UTF-8	Spanish	Spain	UTF-8	CEJ\$ESF8
en_ZA.ISO8859-1	English	South Africa	ISO8859-1	CEJ\$EZI1
en_ZA.ISO8859-15	English	South Africa	ISO8859-15	CEJ\$EZIF
es_AR.ISO8859-1	Spanish	Argentina	ISO8859-1	CEJ\$EAI1
es_AR.ISO8859-15	Spanish	Argentina	ISO8859-15	CEJ\$EAI1F
es_BO.ISO8859-1	Spanish	Bolivia	ISO8859-1	CEJ\$EOI1

Table 363. Compiled ASCII locales supplied with z/OS XL C/C++ (continued)

Locale name as in setlocale() argument	Language	Country / Territory	Codeset	Load module name
es_BO.ISO8859-15	Spanish	Bolivia	ISO8859-15	CEJ\$EOIF
es_CL.ISO8859-1	Spanish	Chile	ISO8859-1	CEJ\$EHI1
es_CL.ISO8859-15	Spanish	Chile	ISO8859-15	CEJ\$EHIF
es_CO.ISO8859-1	Spanish	Colombia	ISO8859-1	CEJ\$FGI1
es_CO.ISO8859-15	Spanish	Colombia	ISO8859-15	CEJ\$FGIF
es_CR.ISO8859-1	Spanish	Costa Rica	ISO8859-1	CEJ\$ERI1
es_CR.ISO8859-15	Spanish	Costa Rica	ISO8859-15	CEJ\$ERIF
es_DO.ISO8859-1	Spanish	Dominican Republic	ISO8859-1	CEJ\$EDI1
es_DO.ISO8859-15	Spanish	Dominican Republic	ISO8859-15	CEJ\$EDIF
es_EC.ISO8859-1	Spanish	Ecuador	ISO8859-1	CEJ\$EQI1
es_EC.ISO8859-15	Spanish	Ecuador	ISO8859-15	CEJ\$EQIF
es_ES.UTF-8@euro	Spanish	Spain (euro) Link to base	UTF-8	CEJ@ESF8
es_ES.UTF-8@preeuro	Spanish	Spain (preeuro)	UTF-8	CEJ3ESF8
es_GT.ISO8859-1	Spanish	Guatemala	ISO8859-1	CEJ\$EGI1
es_GT.ISO8859-15	Spanish	Guatemala	ISO8859-15	CEJ\$EGIF
es_HN.ISO8859-1	Spanish	Honduras	ISO8859-1	CEJ\$FEI1
es_HN.ISO8859-15	Spanish	Honduras	ISO8859-15	CEJ\$FEIF
es_MX.ISO8859-1	Spanish	Mexico	ISO8859-1	CEJ\$EMI1
es_MX.ISO8859-15	Spanish	Mexico	ISO8859-15	CEJ\$EMIF
es_NI.ISO8859-1	Spanish	Nicaragua	ISO8859-1	CEJ\$FAI1
es_NI.ISO8859-15	Spanish	Nicaragua	ISO8859-15	CEJ\$FAIF
es_PA.ISO8859-1	Spanish	Panama	ISO8859-1	CEJ\$EPI1
es_PA.ISO8859-15	Spanish	Panama	ISO8859-15	CEJ\$EPIF
es_PE.ISO8859-1	Spanish	Peru	ISO8859-1	CEJ\$EWI1
es_PE.ISO8859-15	Spanish	Peru	ISO8859-15	CEJ\$EWIF
es_PR.ISO8859-1	Spanish	Puerto Rico	ISO8859-1	CEJ\$EXI1
es_PR.ISO8859-15	Spanish	Puerto Rico	ISO8859-15	CEJ\$EXIF
es_PY.ISO8859-1	Spanish	Paraguay	ISO8859-1	CEJ\$EYI1
es_PY.ISO8859-15	Spanish	Paraguay	ISO8859-15	CEJ\$EYIF
es_SV.ISO8859-1	Spanish	El Salvador	ISO8859-1	CEJ\$EVI1
es_SV.ISO8859-15	Spanish	El Salvador	ISO8859-15	CEJ\$EVIF
es_US.ISO8859-1	Spanish	United States	ISO8859-1	CEJ\$ETI1
es_US.ISO8859-15	Spanish	United States	ISO8859-15	CEJ\$ETIF
es_UY.ISO8859-1	Spanish	Uruguay	ISO8859-1	CEJ\$FDI1
es_UY.ISO8859-15	Spanish	Uruguay	ISO8859-15	CEJ\$FDIF
es_VE.ISO8859-1	Spanish	Venezuela	ISO8859-1	CEJ\$EFI1
es_VE.ISO8859-15	Spanish	Venezuela	ISO8859-15	CEJ\$EFIF
es_VEO.ISO8859-1	Spanish	Venezuela	ISO8859-1	CEJ\$VOI1

Table 363. Compiled ASCII locales supplied with z/OS XL C/C++ (continued)

Locale name as in setlocale() argument	Language	Country / Territory	Codeset	Load module name
es_VEO.IBM-923	Spanish	Venezuela	IBM-923	CEJ\$VOIF
et_EE.UTF-8	Estonian	Estonia	UTF-8	CEJ\$EEF8
et_EE.UTF-8@euro	Estonian	Estonia (euro)	UTF-8	CEJ@EEF8
et_EE.UTF-8@preeuro	Estonian	Estonia (preeuro) Link to base	UTF-8	CEJ3EEF8
eu_ES.UTF-8	Spanish Basque	Spain	UTF-8	CEJ\$BSF8
fi_FI.ISO8859-1	Finnish	Finland	ISO8859-1	CEJ\$FII1
fi_FI.UTF-8	Finnish	Finland	UTF-8	CEJ\$FIF8
fi_FI.UTF-8@euro	Finnish	Finland (euro) Link to base	UTF-8	CEJ@FIF8
fi_FI.UTF-8@preeuro	Finnish	Finland (preeuro)	UTF-8	CEJ3FIF8
fr_BE.ISO8859-1	French	Belgium	ISO8859-1	CEJ\$FBI1
fr_BE.UTF-8	French	Belgium	UTF-8	CEJ\$FBF8
fr_BE.UTF-8@euro	French	Belgium (euro) Link to base	UTF-8	CEJ@FBF8
fr_BE.UTF-8@preeuro	French	Belgium (preeuro)	UTF-8	CEJ3\$FBF8
fr_CA.ISO8859-1	French	Canada	ISO8859-1	CEJ\$FCI1
fr_CA.UTF-8	French	Canada	UTF-8	CEJ\$FCF8
fr_CH.ISO8859-1	French	Switzerland	ISO8859-1	CEJ\$FSI1
fr_CH.UTF-8	French	Switzerland	UTF-8	CEJ\$FSF8
fr_FR.ISO8859-1	French	France	ISO8859-1	CEJ\$FFI1
fr_FR.UTF-8	French	France	UTF-8	CEJ\$FFF8
fr_FR.UTF-8@euro	French	France (euro) Link to base	UTF-8	CEJ@FFF8
fr_FR.UTF-8@preeuro	French	France (preeuro)	UTF-8	CEJ3\$FFF8
fr_LU.UTF-8	French	Luxemburg	UTF-8	CEJ\$FLF8
fr_LU.UTF-8@euro	French	Luxemburg (euro) Link to base	UTF-8	CEJ@FLF8
fr_LU.UTF-8@preeuro	French	Luxemburg (preeuro)	UTF-8	CEJ3FLF8
gl_ES.UTF-8	Spanish Galician	Spain	UTF-8	CEJ\$GSF8
gu_IN.UTF-8	Gujarati	India	UTF-8	CEJ\$GIF8
he_IL.ISO8859-8	Hebrew	Israel	ISO8859-8	CEJ\$IILI8
he_IL.UTF-8	Hebrew	Israel	UTF-8	CEJ\$IILF8
hi_IN.UTF-8	Hindi	India	UTF-8	CEJ\$INF8
hr_HR.ISO8859-2	Croatian	Croatia	ISO8859-2	CEJ\$HRI2
hr_HR.UTF-8	Croatian	Croatia	UTF-8	CEJ\$HRF8
hu_HU.ISO8859-2	Hungarian	Hungary	ISO8859-2	CEJ\$HUI2
hu_HU.UTF-8	Hungarian	Hungary	UTF-8	CEJ\$HUF8
hu_HU.UTF-8@euro	Hungarian	Hungary (euro)	UTF-8	CEJ@HUF8
hu_HU.UTF-8@preeuro	Hungarian	Hungary (preeuro) Link to base	UTF-8	CEJ3HUF8

Table 363. Compiled ASCII locales supplied with z/OS XL C/C++ (continued)

Locale name as in setlocale() argument	Language	Country / Territory	Codeset	Load module name
hy_AM.UTF-8	Armenian	Armenia	UTF-8	CEJ\$HMF8
id_ID.ISO8859-1	Indonesian	Indonesia	ISO8859-1	CEJ\$III1
is_IS.UTF-8	Icelandic	Iceland	UTF-8	CEJ\$ISF8
it_CH.ISO8859-1	Italian	Switzerland	ISO8859-1	CEJ\$IC11
it_CH.ISO8859-15	Italian	Switzerland	ISO8859-15	CEJ\$IC1F
it_IT.ISO8859-1	Italian	Italy	ISO8859-1	CEJ\$ITI1
it_IT.UTF-8	Italian	Italy	UTF-8	CEJ\$ITF8
it_IT.UTF-8@euro	Italian	Italy (euro) Link to base	UTF-8	CEJ@ITF8
it_IT.UTF-8@preeuro	Italian	Italy (preeuro)	UTF-8	CEJ3ITF8
iw_IL.ISO8859-8	Hebrew	Israel	ISO8859-8	CEJ\$ILI8
iw_IL.UTF-8	Hebrew	Israel	UTF-8	CEJ\$ILF8
ja_JP.IBM-943	Japanese	Japan	IBM-943	CEJ\$JAAJ
ja_JP.UTF-8	Japanese	Japan	UTF-8	CEJ\$JAF8
ka_GE.UTF-8	Georgian	Georgia	UTF-8	CEJ\$KEF8
kk_KZ.UTF-8	Kazakh	Kazakstan	UTF-8	CEJ\$KKF8
kn_IN.UTF-8	Kannada	India	UTF-8	CEJ\$KIF8
ko_KR.IBM-eucKR	Korean	Korea	IBM-eucKR	CEJ\$KRBZ
ko_KR.UTF-8	Korean	Korea	UTF-8	CEJ\$KRF8
lt_LT.UTF-8	Lithuanian	Lithuania	UTF-8	CEJ\$LTF8
lt_LT.UTF-8@euro	Lithuanian	Lithuania (euro)	UTF-8	CEJ@LTF8
lt_LT.UTF-8@preeuro	Lithuanian	Lithuania (preeuro) Link to base	UTF-8	CEJ3LTF8
lv_LV.IBM-901	Latvian	Latvia	901	CEJ\$LLLH
lv_LV.IBM-921	Latvian	Latvia	921	CEJ\$LLBD
lv_LV.UTF-8	Latvian	Latvia	UTF-8	CEJ\$LLF8
lv_LV.UTF-8@euro	Latvian	Latvia (euro)	UTF-8	CEJ@LLF8
lv_LV.UTF-8@preeuro	Latvian	Latvia (preeuro) Link to base	UTF-8	CEJ3LLF8
mr_IN.UTF-8	Marati	India	UTF-8	CEJ\$MIF8
ms_MY.ISO8859-1	Malay	Malaysia	ISO8859-1	CEJ\$MYI1
mt_MT.UTF-8	Maltese	Malta	UTF-8	CEJ\$MTF8
mt_MT.UTF-8@euro	Maltese	Malta (euro)	UTF-8	CEJ@MTF8
mt_MT.UTF-8@preeuro	Maltese	Malta (preeuro) Link to base	UTF-8	CEJ3MTF8
nb_NO.UTF-8	Norwegian Bokmal	Norway	UTF-8	CEJ\$NKF8
nl_BE.UTF-8	Dutch	Belgium	UTF-8	CEJ\$NBF8
nl_BE.UTF-8@euro	Dutch	Belgium (euro), Link to base	UTF-8	CEJ@NBF8
nl_BE.UTF-8@preeuro	Dutch	Belgium (preeuro)	UTF-8	CEJ3NBF8
nl_NL.ISO8859-1	Dutch	Netherlands	ISO8859-1	CEJ\$NNI1

Table 363. Compiled ASCII locales supplied with z/OS XL C/C++ (continued)

Locale name as in setlocale() argument	Language	Country / Territory	Codeset	Load module name
nl_NL.UTF-8	Dutch	Netherlands	UTF-8	CEJ\$NNF8
nl_NL.UTF-8@euro	Dutch	Netherlands (euro) Link to base	UTF-8	CEJ@NNF8
nl_NL.UTF-8@preeuro	Dutch	Netherlands (preeuro)	UTF-8	CEJ3NNF8
nn_NO.UTF-8	Norwegian Nynorsk	Norway	UTF-8	CEJ\$NYF8
no_NO.ISO8859-1	Norwegian	Norway	ISO8859-1	CEJ\$NOI1
no_NO.UTF-8	Norwegian	Norway	UTF-8	CEJ\$NOF8
pa_IN.UTF-8	Punjabi	India	UTF-8	CEJ\$PIF8
pl_PL.ISO8859-2	Polish	Poland	ISO8859-2	CEJ\$PLI2
pl_PL.UTF-8	Polish	Poland	UTF-8	CEJ\$PLF8
pl_PL.UTF-8@euro	Polish	Poland (euro)	UTF-8	CEJ@PLF8
pl_PL.UTF-8@preeuro	Polish	Poland (preeuro) Link to base	UTF-8	CEJ3PLF8
pt_BR.ISO8859-1	Portuguese	Brazil	ISO8859-1	CEJ\$BRI1
pt_BR.UTF-8	Portuguese	Brazil	UTF-8	CEJ\$BRF8
pt_PT.ISO8859-1	Portuguese	Portugal	ISO8859-1	CEJ\$PTI1
pt_PT.UTF-8	Portuguese	Portugal	UTF-8	CEJ\$PTF8
pt_PT.UTF-8@euro	Portuguese	Portugal (euro) Link to base	UTF-8	CEJ@PTF8
pt_PT.UTF-8@preeuro	Portuguese	Portugal (preeuro)	UTF-8	CEJ3PTF8
ro_RO.ISO8859-2	Romanian	Romania	ISO8859-2	CEJ\$ROI2
ro_RO.UTF-8	Romanian	Romania	UTF-8	CEJ\$ROF8
ru_RU.ISO8859-5	Russian	Russia	ISO8859-5	CEJ\$RUI5
ru_RU.UTF-8	Russian	Russia	UTF-8	CEJ\$RUF8
sh_CS.UTF-8	Serbian (Latin)	Serbia and Montenegro	UTF-8	CEJ\$SNF8
sk_SK.ISO8859-2	Slovak	Slovakia	ISO8859-2	CEJ\$SKI2
sk_SK.UTF-8	Slovak	Slovakia	UTF-8	CEJ\$SKF8
sk_SK.UTF-8@euro	Slovak	Slovakia (euro)	UTF-8	CEJ@SKF8
sk_SK.UTF-8@preeuro	Slovak	Slovakia (preeuro)	UTF-8	CEJ3SKF8
sl_SI.ISO8859-2	Slovene	Slovenia	ISO8859-2	CEJ\$SII2
sl_SI.UTF-8	Slovene	Slovenia	UTF-8	CEJ\$SIF8
sl_SI.UTF-8@euro	Slovene	Slovenia (euro)	UTF-8	CEJ@SIF8
sl_SI.UTF-8@preeuro	Slovene	Slovenia (preeuro) Link to base	UTF-8	CEJ3SIF8
sq_AL.UTF-8	Albanian	Albania	UTF-8	CEJ\$SAF8
sr_CS.UTF-8	Serbian (Cyrillic)	Serbia and Montenegro	UTF-8	CEJ\$SYF8
sr_RS.UTF-8	Cyrillic	Serbia	UTF-8	CEJ\$SRF8
sv_SE.ISO8859-1	Swedish	Sweden	ISO8859-1	CEJ\$SVI1
sv_SE.UTF-8	Swedish	Sweden	UTF-8	CEJ\$SVF8
sv_SE.UTF-8@euro	Swedish	Sweden (euro)	UTF-8	CEJ@SVF8

Table 363. Compiled ASCII locales supplied with z/OS XL C/C++ (continued)

Locale name as in setlocale() argument	Language	Country / Territory	Codeset	Load module name
sv_SE.UTF-8@preeuro	Swedish	Sweden (preeuro) Link to base	UTF-8	CEJ3SVF8
sw_KE.UTF-8	Kenyan Swahili	Kenya	UTF-8	CEJ\$SEF8
sw_TZ.UTF-8	Tanzania Swahili	Tanzania	UTF-8	CEJ\$SZF8
ta_IN.UTF-8	Tamil	India	UTF-8	CEJ\$ANF8
te_IN.UTF-8	Telugu	India	UTF-8	CEJ\$ENF8
th_TH.TIS-620	Thai	Thailand	TIS-620	CEJ\$THBU
th_TH.UTF-8	Thai	Thailand	UTF-8	CEJ\$THF8
tr_TR.ISO8859-9	Turkish	Turkey	ISO8859-9	CEJ\$TRI9
tr_TR.UTF-8	Turkish	Turkey	UTF-8	CEJ\$TRF8
uk_UA.IBM-1124	Ukrainian	Ukraine	IBM-1124	CEJ\$UUAU
vi_VN.UTF-8	Vietnamese	Vietnam	UTF-8	CEJ\$VIF8
zh_CN.IBM-eucCN	Simplified Chinese	China(PRC)	IBM-eucCN	CEJ\$ZCXY
zh_CN.UTF-8	Simplified Chinese	China(PRC)	UTF-8	CEJ\$ZCF8
zh_HK.UTF-8	Chinese	China (Hong Kong S.A.R. of China)	UTF-8	CEJ\$ZKF8
zh_HKS.UTF-8	Simplified Chinese	China (Hong Kong S.A.R. of China)	UTF-8	CEJ\$ZGF8
zh_HKT.UTF-8	Traditional Chinese	China (Hong Kong S.A.R. of China)	UTF-8	CEJ\$ZUF8
zh_SG.UTF-8	Chinese	Singapore	UTF-8	CEJ\$ZPF8
zh_SGS.UTF-8	Simplified Chinese	Singapore	UTF-8	CEJ\$ZSF8
zh_TW.BIG5	Simplified Chinese	Taiwan	BIG5	CEJ\$ZTBT
zh_TW.UTF-8	Simplified Chinese	Taiwan	UTF-8	CEJ\$ZTF8
zu_ZA.UTF-8	South African Zulu	South Africa	UTF-8	CEJ\$ZAF8

Table 364. ASCII locale object names and method files in the z/OS UNIX file system

UNIX file system Locale Object Name	Method File
bg_BG.UTF-8	utfmeth.m
ca_ES.UTF-8	utfmeth.m
ca_ES.UTF-8@euro	utfmeth.m
ca_ES.UTF-8@preeuro	utfmeth.m
cs_CZ.ISO8859-2.xplink	sbmeth.m
cs_CZ.UTF-8.xplink	utfmeth.m
cs_CZ.UTF-8@euro	utfmeth.m
cs_CZ.UTF-8@preeuro	utfmeth.m
cy_GB.UTF-8	utfmeth.m
cy_GB.UTF-8@euro	utfmeth.m
da_DK.ISO8859-1.xplink	iso1meth.m
da_DK.UTF-8.xplink	utfmeth.m

Table 364. ASCII locale object names and method files in the z/OS UNIX file system (continued)

UNIX file system Locale Object Name	Method File
da_DK.UTF-8@euro	utfmeth.m
de_AT.UTF-8	utfmeth.m
de_AT.UTF-8@euro	utfmeth.m
de_AT.UTF-8@preeuro	utfmeth.m
de_CH.ISO8859-1.xplink	iso1meth.m
de_CH.UTF-8.xplink	utfmeth.m
de_DE.ISO8859-1.xplink	iso1meth.m
de_DE.UTF-8.xplink	utfmeth.m
de_DE.UTF-8@euro	utfmeth.m
de_DE.UTF-8@preeuro	utfmeth.m
de_LU.UTF-8	utfmeth.m
de_LU.UTF-8@euro	utfmeth.m
de_LU.UTF-8@preeuro	utfmeth.m
el_GR.ISO8859-7.xplink	sbmeth.m
el_GR.UTF-8.xplink	utfmeth.m
el_GR.UTF-8@euro	utfmeth.m
el_GR.UTF-8@preeuro	utfmeth.m
en_AU.ISO8859-1	iso1meth.m
en_BE.UTF-8	utfmeth.m
en_BE.UTF-8@euro	utfmeth.m
en_BE.UTF-8@preeuro	utfmeth.m
en_GB.ISO8859-1.xplink	iso1meth.m
en_GB.UTF-8.xplink	utfmeth.m
en_GB.UTF-8@euro	utfmeth.m
en_HK.ISO8859-1	iso1meth.m
en_IE.UTF-8	utfmeth.m
en_IE.UTF-8@euro	utfmeth.m
en_IE.UTF-8@preeuro	utfmeth.m
en_IN.ISO8859-11	iso1meth.m
en_NZ.ISO8859-1	iso1meth.m
en_PH.ISO8859-1	iso1meth.m
en_SG.ISO8859-1	iso1meth.m
en_US.ISO8859-1.xplink	iso1meth.m
en_US.UTF-8.xplink	utfmeth.m
es_ES.ISO8859-1.xplink	iso1meth.m
es_ES.UTF-8.xplink	utfmeth.m
es_ES.UTF-8@euro	utfmeth.m
es_ES.UTF-8@preeuro	utfmeth.m
et_EE.UTF-8	utfmeth.m
et_EE.UTF-8@euro	utfmeth.m

Table 364. ASCII locale object names and method files in the z/OS UNIX file system (continued)

UNIX file system Locale Object Name	Method File
et_EE.UTF-8@preeuro	utfmeth.m
fi_FI.ISO8859-1.xplink	iso1meth.m
fi_FI.UTF-8.xplink	utfmeth.m
fi_FI.UTF-8@euro	utfmeth.m
fi_FI.UTF-8@preeuro	utfmeth.m
fr_BE.ISO8859-1.xplink	iso1meth.m
fr_BE.UTF-8.xplink	utfmeth.m
fr_BE.UTF@euro	utfmeth.m
fr_BE.UTF-8@preeuro	utfmeth.m
fr_CA.ISO8859-1.xplink	iso1meth.m
fr_CA.UTF-8.xplink	utfmeth.m
fr_CH.ISO8859-1.xplink	iso1meth.m
fr_CH.UTF-8.xplink	utfmeth.m
fr_FR.ISO8859-1.xplink	iso1meth.m
fr_FR.UTF-8.xplink	utfmeth.m
fr_FR.UTF-8@euro	utfmeth.m
fr_FR.UTF-8@preeuro	utfmeth.m
fr_LU.UTF-8	utfmeth.m
fr_LU.UTF-8@euro	utfmeth.m
fr_LU.UTF-8@preeuro	utfmeth.m
gu_IN.UTF-8	utfmeth.m
he_IL.ISO8859-8.xplink	sbmeth.m
he_IL.UTF-8.xplink	utfmeth.m
hi_IN.UTF-8.xplink	utfmeth.m
hr_HR.ISO8859-2.xplink	sbmeth.m
hr_HR.UTF-8.xplink	utfmeth.m
hu_HU.ISO8859-2.xplink	sbmeth.m
hu_HU.UTF-8.xplink	utfmeth.m
hu_HU.UTF-8@euro	utfmeth.m
hu_HU.UTF-8@preeuro	utfmeth.m
id_ID.ISO8859-1	iso1meth.m
is_IS.UTF-8	utfmeth.m
it_IT.ISO8859-1.xplink	iso1meth.m
it_IT.UTF-8.xplink	utfmeth.m
it_IT.UTF-8@euro	utfmeth.m
it_IT.UTF-8@preeuro	utfmeth.m
ja_JP.IBM-943.xplink	stdmeth.m
ja_JP.UTF-8.xplink	utfmeth.m
kk_KZ.UTF-8.xplink	utfmeth.m
kn_IN.UTF-8	utfmeth.m



Table 364. ASCII locale object names and method files in the z/OS UNIX file system (continued)

UNIX file system Locale Object Name	Method File
ko_KR.IBM-eucKR.xplink	stdmeth.m
ko_KR.UTF-8.xplink	utfmeth.m
lt_LT.UTF-8	utfmeth.m
lt_LT.UTF-8@euro	utfmeth.m
lt_LT.UTF-8@preeuro	utfmeth.m
lv_LV.UTF-8	utfmeth.m
lv_LV.UTF-8@euro	utfmeth.m
lv_LV.UTF-8@preeuro	utfmeth.m
mr_IN.UTF-8	utfmeth.m
ms_MY.ISO8859-1	iso1meth.m
mt_MT.UTF-8	utfmeth.m
mt_MT.UTF-8@euro	utfmeth.m
mt_MT.UTF-8@preeuro	utfmeth.m
nb_NO.UTF-8	utfmeth.m
nl_BE.UTF-8	utfmeth.m
nl_BE.UTF-8@euro	utfmeth.m
nl_BE.UTF-8@preeuro	utfmeth.m
nl_NL.ISO8859-1.xplink	iso1meth.m
nl_NL.UTF-8.xplink	utfmeth.m
nl_NL.UTF-8@euro	utfmeth.m
nl_NL.UTF-8@preeuro	utfmeth.m
no_NO.ISO8859-1.xplink	iso1meth.m
no_NO.UTF-8.xplink	utfmeth.m
pl_PL.ISO8859-2.xplink	sbmeth.m
pl_PL.UTF-8.xplink	utfmeth.m
pl_PL.UTF-8@euro	utfmeth.m
pl_PL.UTF-8@preeuro	utfmeth.m
pt_BR.ISO8859-1.xplink	iso1meth.m
pt_BR.UTF-8.xplink	utfmeth.m
pt_PT.ISO8859-1.xplink	iso1meth.m
pt_PT.UTF-8.xplink	utfmeth.m
pt_PT.UTF-8@euro	utfmeth.m
pt_PT.UTF-8@preeuro	utfmeth.m
ro_RO.ISO8859-2.xplink	iso1meth.m
ro_RO.UTF-8.xplink	utfmeth.m
ru_RU.ISO8859-5.xplink	sbmeth.m
ru_RU.UTF-8.xplink	utfmeth.m
sh_CS.UTF-8	utfmeth.m
sk_SK.ISO8859-2.xplink	sbmeth.m
sk_SK.UTF-8.xplink	utfmeth.m

Table 364. ASCII locale object names and method files in the z/OS UNIX file system (continued)

UNIX file system Locale Object Name	Method File
sk_SK.UTF-8@euro	utfmeth.m
sk_SK.UTF-8@preeuro	utfmeth.m
sl_SI.ISO8859-2.xplink	sbmeth.m
sl_SI.UTF-8.xplink	utfmeth.m
sl_SI.UTF-8@euro	utfmeth.m
sl_SI.UTF-8@preeuro	utfmeth.m
sq_AL.UTF-8	utfmeth.m
sr_CS.UTF-8	utfmeth.m
sv_SE.ISO8859-1.xplink	iso1meth.m
sv_SE.UTF-8.xplink	utfmeth.m
sv_SE.UTF-8@euro	utfmeth.m
sv_SE.UTF-8@preeuro	utfmeth.m
ta_IN.UTF-88.xplink	utfmeth.m
te_IN.UTF-8.xplink	utfmeth.m
th_TH.TIS-620.xplink	sbmeth.m
th_TH.UTF-8.xplink	utfmeth.m
tr_TR.ISO8859-9.xplink	sbmeth.m
tr_TR.UTF-8.xplink	utfmeth.m
uk-UA.IBM-1124.xplink	iso1meth.m
vi_VN_UTF-8	utfmeth.m
zh_CN.IBM-eucCN.xplink	stdmeth.m
zh_CN.UTF-8.xplink	utf_asia.m
zh_HK.UTF-8	utfmeth.m
zh_SG.UTF-8	utfmeth.m
zh_TW.BIG5.xplink	stdmeth.m
zh_TW.UTF-8.xplink	utfmeth.m

## Locale source files

The locale source files are supplied to enable you to build locales in coded character sets other than those supplied. The locale sources supplied are listed in the following table in sequence by source file name.

The “Applicable Codesets” column indicates which charmap files can be used with the source files to build the locales. The values in this column indicate the following:

**All** The locale source contains only the portable character set and can be used to build a locale with any of the supplied charmap files.

### Latin-1

The locale source contains characters from the Latin-1 character set, and can be used to build a locale from any of the supplied Latin-1 charmap files. See Appendix E, “Charmap files supplied with z/OS XL C/C++,” on page 1117 for a list of Latin-1 charmap files.

**Other** The locale source is specific to the specified coded character set, and can only be used to build a locale with the specified charmap file.

Table 365. Locale source files supplied with z/OS XL C/C++

Language	Country / Territory	Source name	Applicable Codesets
POSIX (built-in)		EDC\$PO SX	All
SAA (built-in)		EDC\$SAAC	Latin-1
Arabic	Algeria, Bahrain, Egypt, Iraq, Jordan, Kuwait, Lebanon, Libya, Morocco, Oman, Qatar, Saudi Arabia, Syria, Tunisia, U.A.E., Yemen	EDC\$AAAR	IBM-425
Bulgarian	Bulgaria	EDC\$BGFE	IBM-1025
Bulgarian	Bulgaria	EDC\$BGHT	IBM-1154
Portuguese	Brazil	EDC\$BREY	Latin-1
Portuguese	Brazil	EDC\$BRHA	IBM-1140
Portuguese	Brazil	EDC@BRHA	IBM-1140
Catalan	Spain	EDC\$CSEZ	IBM-924
Catalan	Spain	EDC@CSEZ	IBM-924
Czech	Czech Republic	EDC\$CZ EQ	IBM-870
Czech	Czech Republic	EDC\$CZ MB	IBM-1153
Danish	Denmark	EDC\$DAEY	Latin-1
Danish	Denmark	EDC\$DAEZ	IBM-924
Danish	Denmark	EDC@DAEZ	IBM-924
Danish	Denmark	EDC\$DAHE	IBM-1142
Danish	Denmark	EDC@DAHE	IBM-1142
German	Switzerland	EDC\$DCEY	Latin-1
German	Switzerland	EDC\$DCHO	IBM-1148
German	Switzerland	EDC@DCHO	IBM-1148
German	Germany	EDC\$DDEY	Latin-1
German	Germany	EDC\$DDEZ	IBM-924
German	Germany	EDC@DDEZ	IBM-924
German	Germany	EDC\$DDHB	IBM-1141
German	Germany	EDC@DDHB	IBM-1141
German	Luxembourg	EDC\$DLEZ	IBM-924
German	Luxembourg	EDC@DLEZ	IBM-924
German	Austria	EDC\$DTEZ	IBM-924
German	Austria	EDC@DTEZ	IBM-924
Estonian	Estonia	EDC\$EEFD	IBM-1122
Estonian	Estonia	EDC\$EEHD	IBM-1157
English	Belgium	EDC\$EBEZ	IBM-924
English	Belgium	EDC@EBEZ	IBM-924
English	Ireland	EDC\$EIEZ	IBM-924
English	Ireland	EDC@EIEZ	IBM-924

Table 365. Locale source files supplied with z/OS XL C/C++ (continued)

Language	Country / Territory	Source name	Applicable Codesets
English	Japan	EDC\$EJEX	IBM-1027
English	Japan	EDC\$EJHX	IBM-5123
English	United Kingdom	EDC\$EKEY	Latin-1
English	Great Britain	EDC\$EKEZ	IBM-924
English	Great Britain	EDC@EKEZ	IBM-924
English	United Kingdom	EDC\$EKHK	IBM-1146
English	United Kingdom	EDC@EKHK	IBM-1146
Greek	Greece	EDC\$ELHS	IBM-4971
Greek	Greece	EDC@ELHS	IBM-4971
Greek	Greece	EDC\$ELES	IBM-875
Spanish	Spain	EDC\$ESEY	Latin-1
Spanish	Spain	EDC\$ESEZ	IBM-924
Spanish	Spain	EDC@ESEZ	IBM-924
Spanish	Spain	EDC\$ESHJ	IBM-1145
Spanish	Spain	EDC@ESHJ	IBM-1145
English	United States	EDC\$EUEY	Latin-1
English	United States	EDC\$EUHA	IBM-1140
English	United States	EDC@EUHA	IBM-1140
French	Belgium	EDC\$FBEY	Latin-1
French	Belgium	EDC\$FBEZ	IBM-924
French	Belgium	EDC@FBEZ	IBM-924
French	Belgium	EDC\$FBHO	IBM-1148
French	Belgium	EDC@FBHO	IBM-1148
French	Canada	EDC\$FCEY	Latin-1
French	Canada	EDC\$FCHA	IBM-1140
French	Canada	EDC@FCHA	IBM-1140
French	France	EDC\$FFEY	Latin-1
French	France	EDC\$FFEZ	IBM-924
French	France	EDC@FFEZ	IBM-924
French	France	EDC\$FFHM	IBM-1147
French	France	EDC@FFHM	IBM-1147
Finnish	Finland	EDC\$FIEY	Latin-1
Finnish	Finland	EDC\$FIEZ	IBM-924
Finnish	Finland	EDC@FIEZ	IBM-924
Finnish	Finland	EDC\$FIHF	IBM-1143
Finnish	Finland	EDC@FIHF	IBM-1143
French	Luxembourg	EDC\$FLEZ	IBM-924
French	Luxembourg	EDC@FLEZ	IBM-924
French	Switzerland	EDC\$FSEY	Latin-1
French	Switzerland	EDC\$FSHO	IBM-1148

Table 365. Locale source files supplied with z/OS XL C/C++ (continued)

Language	Country / Territory	Source name	Applicable Codesets
French	Switzerland	EDC@FSHO	IBM-1148
Croatian	Croatia	EDC\$HREQ	IBM-870
Croatian	Croatia	EDC\$HRMB	IBM-1153
Hungarian	Hungary	EDC\$HUEQ	IBM-870
Hungarian	Hungary	EDC\$HUMB	IBM-1153
Hebrew	Israel	EDC\$ILFB	IBM-424
Hebrew	Israel	EDC\$ILHH	IBM12712
Icelandic	Iceland	EDC\$ISEY	Latin-1
Icelandic	Iceland	EDC\$ISHR	IBM-1149
Icelandic	Iceland	EDC@ISHR	IBM-1149
Italian	Italy	EDC\$ITEY	Latin-1
Italian	Italy	EDC\$ITEZ	IBM-924
Italian	Italy	EDC@ITEZ	IBM-924
Italian	Italy	EDC\$ITHG	IBM-1144
Italian	Italy	EDC@ITHG	IBM-1144
Japanese	Japan	EDC\$JAEL	IBM-290
Japanese	Japan	EDC\$JAEU	IBM-930
Japanese	Japan	EDC\$JAEV	IBM-939
Japanese	Japan	EDC\$JAEX	IBM-1027
Japanese	Japan	EDC\$J AHL	IBM-8482
Japanese	Japan	EDC\$JAHU	IBM-1390
Japanese	Japan	EDC\$JAHV	IBM-1399
Japanese	Japan	EDC\$JAHX	IBM-5123
Korean	Korea	EDC\$KRGZ	IBM-933
Korean	Korea	EDC\$K RKZ	IBM-1364
Lithuanian	Lithuania	EDC\$LTGD	IBM-1112
Lithuanian	Lithuania	EDC\$LTHZ	IBM-1156
Macedonian	Macedonia	EDC\$MMFE	IBM-1025
Macedonian	Macedonia	EDC\$MMHT	IBM-1154
Dutch	Belgium	EDC\$NB EY	Latin-1
Dutch	Belgium	EDC\$NB EZ	IBM-924
Dutch	Belgium	EDC@NB EZ	IBM-924
Dutch	Belgium	EDC\$NB HO	IBM-1148
Dutch	Belgium	EDC@NB HO	IBM-1148
Dutch	Netherlands	EDC\$NNE Y	Latin-1
Dutch	Netherlands	EDC\$NNE Z	IBM-924
Dutch	Netherlands	EDC@NNE Z	IBM-924
Dutch	Netherlands	EDC\$NN HA	IBM-1140
Dutch	Netherlands	EDC@NN HA	IBM-1140
Norwegian	Norway	EDC\$NOE Y	Latin-1

Table 365. Locale source files supplied with z/OS XL C/C++ (continued)

Language	Country / Territory	Source name	Applicable Codesets
Norwegian	Norway	EDC\$NOHE	IBM-1142
Norwegian	Norway	EDC@NOHE	IBM-1142
Polish	Poland	EDC\$PLEQ	IBM-870
Polish	Poland	EDC\$PLMB	IBM-1153
Portuguese	Portugal	EDC\$PTEY	Latin-1
Portuguese	Portugal	EDC\$PTEZ	IBM-924
Portuguese	Portugal	EDC@PTEZ	IBM-924
Portuguese	Portugal	EDC\$PTHA	IBM-1140
Portuguese	Portugal	EDC@PTHA	IBM-1140
Romanian	Romania	EDC\$ROEQ	IBM-870
Romanian	Romania	EDC\$ROMB	IBM-1153
Russian	Russia	EDC\$RUFEB	IBM-1025
Russian	Russia	EDC\$RUHT	IBM-1154
Albanian	Albania	EDC\$SAEY	Latin-1
Albanian	Albania	EDC\$SAHO	IBM-1148
Albanian	Albania	EDC@SAHO	IBM-1148
Serbian (Cyrillic)	Serbia	EDC\$SCFE	IBM-1025
Serbian (Cyrillic)	Serbia	EDC\$SCHT	IBM-1154
Slovene	Slovenia	EDC\$SIEQ	IBM-870
Slovene	Slovenia	EDC\$SIMB	IBM-1153
Slovak	Slovakia	EDC\$SKEQ	IBM-870
Slovak	Slovakia	EDC\$SKMB	IBM-1153
Serbian (Latin)	Serbia	EDC\$SLEQ	IBM-870
Serbian (Latin)	Serbia	EDC\$SLMB	IBM-1153
Swedish	Sweden	EDC\$SVEY	Latin-1
Swedish	Sweden	EDC\$SVEZ	IBM-924
Swedish	Sweden	EDC@SVEZ	IBM-924
Swedish	Sweden	EDC\$SVHF	IBM-1143
Swedish	Sweden	EDC@SVHF	IBM-1143
Thai	Thailand	EDC\$THEP	IBM-838
Thai	Thailand	EDC\$THHP	IBM-1160
Turkish	Turkey	EDC\$TREW	IBM-1026
Turkish	Turkey	EDC\$TRHW	IBM-1155
Simplified Chinese	China (PRC)	EDC\$ZCGY	IBM-935
Simplified Chinese	China (PRC)	EDC\$ZCGV	IBM-1388
Traditional Chinese	Taiwan	EDC\$ZTGW	IBM-937
Traditional Chinese	Taiwan	EDC\$ZTKA	IBM-1371



---

## Appendix E. Charmap files supplied with z/OS XL C/C++

All the locales supplied were built using the appropriate charmap file that represents the coded character sets described by the CodesetRegistry-CodesetEncoding element of the locale name.

All of these charmap files are provided with the National Language Resources feature of z/OS Language Environment. Consult your system programmer to determine whether they have been installed.

Under MVS, the charmap files are provided in a separate partitioned data set, CEE.SCEECMAP. The - sign is converted to the @ character.

Table 366 lists the coded character set name, which is the same as the name of the corresponding charmap file, and the national language each code set represents. The column marked **Latin-1** indicates if the charmap file is for a coded character set that contains the Latin-1 character set.

*Table 366. Coded character set names and corresponding primary country/territory*

Codeset	Primary Country/Territory	Latin-1
Big5	Taiwan	No
IBM-037	USA, Canada, Brazil	Yes
IBM-273	Germany, Austria	Yes
IBM-274	Belgium	Yes
IBM-277	Denmark, Norway	Yes
IBM-278	Finland, Sweden	Yes
IBM-280	Italy	Yes
IBM-281	Japan (Latin-1)	Yes
IBM-282	Portugal	Yes
IBM-284	Spain, Latin America	Yes
IBM-285	United Kingdom	Yes
IBM-290	Japan (Katakana)	No
IBM-297	France	Yes
IBM-424	Israel	No
IBM-425	Algeria, Bahrain, Egypt, Iraq, Jordan, Kuwait, Lebanon, Libya, Morocco, Oman, Qatar, Saudi Arabia, Syria, Tunisia, U.A.E., Yemen	No
IBM-500	International	Yes
IBM-838	Thailand	No
IBM-870	Croatia, Czech Republic, Hungary, Poland, Romania, Serbia (Latin), Slovakia, Slovenia	No
IBM-871	Iceland	Yes
IBM-875	Greece	No
IBM-901	Estonia, Latvia, Lithuania	No
IBM-921	Estonia, Latvia, Lithuania	No



Table 366. Coded character set names and corresponding primary country/territory (continued)

Codeset	Primary Country/Territory	Latin-1
IBM-923	Multinational	No
IBM-924	Latin 9/Open Systems	No
IBM-930	Japan (Katakana, combined with DBCS)	No
IBM-933	Korea	No
IBM-935	China (PRC)	No
IBM-937	Taiwan	No
IBM-939	Japan (Latin, combined with DBCS)	No
IBM-943	Japan	No
IBM-1025	Bulgaria, Macedonia, Russia, Serbia (Cyrillic)	No
IBM-1026	Turkey	No
IBM-1027	Japan (Latin) extended	No
IBM-1047	Latin 1/Open Systems	Yes
IBM-1112	Lithuania	No
IBM-1122	Estonia	No
IBM-1123	Ukraine	No
IBM-1124	Ukraine	No
IBM-1140	USA, Canada, Brazil	Yes
IBM-1141	Germany, Austria	Yes
IBM-1142	Denmark, Norway	Yes
IBM-1143	Finland, Sweden	Yes
IBM-1144	Italy	Yes
IBM-1145	Spain, Latin America	Yes
IBM-1146	United Kingdom	Yes
IBM-1147	France	Yes
IBM-1148	International	Yes
IBM-1149	Iceland	Yes
IBM-1153	Croatia, Czech Republic, Hungary, Poland, Romania, Serbia (Latin), Slovakia, Slovenia	No
IBM-1154	Bulgaria, Macedonia, Russia, Serbia (Cyrillic)	No
IBM-1155	Turkey	No
IBM-1156	Lithuania	No
IBM-1157	Estonia	No
IBM-1158	Ukraine	No
IBM-1160	Thailand	No
IBM-1165	Multinational	No
IBM-1364	Korea	No
IBM-1371	Taiwan	No
IBM-1388	China (PRC)	No
IBM-1390	Japan	No

Table 366. Coded character set names and corresponding primary country/territory (continued)

Codeset	Primary Country/Territory	Latin-1
IBM-1399	Japan	No
IBM-4971	Greece	No
IBM-5123	Japan	No
IBM-8482	Japan	No
IBM12712	Israel	No
IBMEUCCN	China (PRC)	No
IBMEUCKR	Korea	No
ISO8859-1	All Latin 1 Countries	Yes
ISO8859-2	Croatia, Czech Republic, Hungary, Poland, Romania, Serbia (Latin), Slovakia, Slovenia	No
ISO8859-5	Bulgaria, Macedonia, Russia, Serbia (Cyrillic)	No
ISO8859-7	Greece	No
ISO8859-8	Israel	No
ISO8859-9	Turkey	No
TIS-620	Thailand	No
UTF-8	All Countries	Yes

Only the charmap files for IBM-930, IBM-933, IBM-935, IBM-937, IBM-939 and IBM-1388 specify `<mb_cur_max>` as 4 and include the definition of the double-byte characters.

**Note:** The SAA C locale is built with the charmap IBM-1047, but has `<mb_cur_max>` set to 4 to maintain compatibility with old releases of C/370.

Any of these charmaps that represent the same character set, even though they represent different encoding of the same character sets, can be used with any locale source that uses the same character set, to build a new locale and charmap combination. See Chapter 60, “Building a locale,” on page 955 for information about building your own locales.



---

## Appendix F. Examples of charmap and locale definition source

The following sections show examples of the charmap source and locale definition source files.

---

### Charmap file

Figure 276 shows the charmap file for the encoded character set IBM-1047.

```
<code_set_name>    "IBM-1047"
<mb_cur_max>      1
<mb_cur_min>      1
<escape_char>     /
<comment_char>    %

CHARMAP
<NUL>              /x00
<SOH>              /x01
<STX>              /x02
<ETX>              /x03
<SEL>              /x04
<tab>              /x05
<HT>               /x05
<RNL>              /x06
<DEL>              /x07
<GE>               /x08
<SPS>              /x09
<RPT>              /x0a
<vertical-tab>    /x0b
<VT>               /x0b
<form-feed>       /x0c
<FF>               /x0c
<carriage-return> /x0d
<CR>               /x0d
<SO>               /x0e
<SI>               /x0f
<DLE>              /x10
<DC1>              /x11
<DC2>              /x12
<DC3>              /x13
<RES>              /x14
<newline>         /x15
<backspace>       /x16
<BS>               /x16
<POC>              /x17
<CAN>              /x18
<EM>               /x19
<UBS>              /x1a
<CU1>              /x1b
<IFS>              /x1c    % file separator
<IS4>              /x1c
<FS>               /x1c
<IGS>              /x1d    % group separator
<IS3>              /x1d
<GS>               /x1d
<IRS>              /x1e    % record separator
<IS2>              /x1e
<RS>               /x1e
<IUS>              /x1f    % unit separator
<IS1>              /x1f
```

*Charmap file (Part 1 of 6)*

*Figure 276. Charmap file*

<US>	/x1f	
<ITB>	/x1f	
<DS>	/x20	
<SOS>	/x21	
<FS>	/x22	% field separator
<WUS>	/x23	
<BYP>	/x24	
<LF>	/x25	
<ETB>	/x26	
<ESC>	/x27	
<SA>	/x28	
<SFE>	/x29	
<SM>	/x2a	
<CSP>	/x2b	
<MFA>	/x2c	
<ENQ>	/x2d	
<ACK>	/x2e	
<alert>	/x2f	
<BEL>	/x2f	
<SYN>	/x32	
<IR>	/x33	
<PP>	/x34	
<TRN>	/x35	
<NBS>	/x36	
<EOT>	/x37	
<SBS>	/x38	
<IT>	/x39	
<RFF>	/x3a	
<CU3>	/x3b	
<DC4>	/x3c	
<NAK>	/x3d	
<SUB>	/x3f	
<space>	/x40	
<SP01>	/x40	
<RSP>	/x41	
<SP30>	/x41	
<a-circumflex>	/x42	
<LA15>	/x42	
<a-diaeresis>	/x43	
<LA17>	/x43	
<a-grave>	/x44	
<LA13>	/x44	
<a-acute>	/x45	
<LA11>	/x45	
<a-tilde>	/x46	
<LA19>	/x46	
<a-ring>	/x47	
<LA27>	/x47	
<c-cedilla>	/x48	
<LC41>	/x48	
<n-tilde>	/x49	
<LN19>	/x49	
<cent>	/x4a	
<SC04>	/x4a	
<period>	/x4b	
<SP11>	/x4b	
<less-than-sign>	/x4c	
<SA03>	/x4c	
<left-parenthesis>	/x4d	
<SP06>	/x4d	
<plus-sign>	/x4e	
<SA01>	/x4e	
<vertical-line>	/x4f	
<SM13>	/x4f	
<ampersand>	/x50	
<SM03>	/x50	
<e-acute>	/x51	
<LE11>	/x51	
<e-circumflex>	/x52	
<LE15>	/x52	
<e-diaeresis>	/x53	
<LE17>	/x53	
<e-grave>	/x54	

*Charmap file (Part 2 of 6)*

<LE13>	/x54
<i-acute>	/x55
<LI11>	/x55
<i-circumflex>	/x56
<LI15>	/x56
<i-diaeresis>	/x57
<LI17>	/x57
<i-grave>	/x58
<LI13>	/x58
<s-sharp>	/x59
<LS61>	/x59
<exclamation-mark>	/x5a
<SP02>	/x5a
<dollar-sign>	/x5b
<SC03>	/x5b
<asterisk>	/x5c
<SM04>	/x5c
<right-parenthesis>	/x5d
<SP07>	/x5d
<semicolon>	/x5e
<SP14>	/x5e
<circumflex>	/x5f
<circumflex-accent>	/x5f
<SD15>	/x5f
<hyphen>	/x60
<hyphen-minus>	/x60
<SP10>	/x60
<slash>	/x61
<SP12>	/x61
<A-circumflex>	/x62
<LA16>	/x62
<A-diaeresis>	/x63
<LA18>	/x63
<A-grave>	/x64
<LA14>	/x64
<A-acute>	/x65
<LA12>	/x65
<A-tilde>	/x66
<LA20>	/x66
<A-ring>	/x67
<LA28>	/x67
<C-cedilla>	/x68
<LC42>	/x68
<N-tilde>	/x69
<LN20>	/x69
<broken-bar>	/x6a
<SM65>	/x6a
<comma>	/x6b
<SP08>	/x6b
<percent-sign>	/x6c
<SM02>	/x6c
<underscore>	/x6d
<SP09>	/x6d
<greater-than-sign>	/x6e
<SA05>	/x6e
<question-mark>	/x6f
<SP15>	/x6f
<o-slash>	/x70
<LO61>	/x70
<E-acute>	/x71
<LE12>	/x71
<E-circumflex>	/x72
<LE16>	/x72
<E-diaeresis>	/x73
<LE18>	/x73
<E-grave>	/x74
<LE14>	/x74
<I-acute>	/x75
<LI12>	/x75
<I-circumflex>	/x76
<LI16>	/x76
<I-diaeresis>	/x77
<LI18>	/x77
<I-grave>	/x78
<LI14>	/x78

*Charmap file (Part 3 of 6)*

<grave-accent>	/x79
<SD13>	/x79
<colon>	/x7a
<SP13>	/x7a
<number-sign>	/x7b
<SM01>	/x7b
<commercial-at>	/x7c
<SM05>	/x7c
<apostrophe>	/x7d
<SP05>	/x7d
<equals-sign>	/x7e
<SA04>	/x7e
<quotation-mark>	/x7f
<SP04>	/x7f
<O-slash>	/x80
<L062>	/x80
<a>	/x81
<LA01>	/x81
<b>	/x82
<LB01>	/x82
<c>	/x83
<LC01>	/x83
<d>	/x84
<LD01>	/x84
<e>	/x85
<LE01>	/x85
<f>	/x86
<LF01>	/x86
<g>	/x87
<LG01>	/x87
<h>	/x88
<LH01>	/x88
<i>	/x89
<LI01>	/x89
<left-angle-quotes>	/x8a
<guillemot-left>	/x8a
<SP17>	/x8a
<right-angle-quotes>	/x8b
<guillemot-right>	/x8b
<SP18>	/x8b
<eth>	/x8c
<LD63>	/x8c
<y-acute>	/x8d
<LY11>	/x8d
<thorn>	/x8e
<LT63>	/x8e
<plus-minus>	/x8f
<SA02>	/x8f
<degree>	/x90
<SM19>	/x90
<j>	/x91
<LJ01>	/x91
<k>	/x92
<LK01>	/x92
<l>	/x93
<LL01>	/x93
<m>	/x94
<LM01>	/x94
<n>	/x95
<LN01>	/x95
<o>	/x96
<LO01>	/x96
<p>	/x97
<LP01>	/x97
<q>	/x98
<LQ01>	/x98
<r>	/x99
<LR01>	/x99
<feminine>	/x9a
<SM21>	/x9a
<masculine>	/x9b
<SM20>	/x9b
<ae>	/x9c
<LA51>	/x9c
<cedilla>	/x9d
<SD41>	/x9d
<AE>	/x9e
<LA52>	/x9e

*Charmap file (Part 4 of 6)*

<currency>	/x9f
<SC01>	/x9f
<mu>	/xa0
<SM17>	/xa0
<tilde>	/xa1
<SD19>	/xa1
<s>	/xa2
<LS01>	/xa2
<t>	/xa3
<LT01>	/xa3
<u>	/xa4
<LU01>	/xa4
<v>	/xa5
<LV01>	/xa5
<w>	/xa6
<LW01>	/xa6
<x>	/xa7
<LX01>	/xa7
<y>	/xa8
<LY01>	/xa8
<z>	/xa9
<LZ01>	/xa9
<exclamation-down>	/xaa
<SP03>	/xaa
<question-down>	/xab
<SP16>	/xab
<Eth>	/xac
<LD62>	/xac
<left-square-bracket>	/xad
<SM06>	/xad
<Thorn>	/xae
<LT64>	/xae
<registered>	/xaf
<SM53>	/xaf
<not>	/xb0
<SM66>	/xb0
<sterling>	/xb1
<SC02>	/xb1
<yen>	/xb2
<SC05>	/xb2
<dot>	/xb3
<SD63>	/xb3
<copyright>	/xb4
<SM52>	/xb4
<section>	/xb5
<SM24>	/xb5
<paragraph>	/xb6
<SM25>	/xb6
<one-quarter>	/xb7
<NF04>	/xb7
<one-half>	/xb8
<NF01>	/xb8
<three-quarters>	/xb9
<NF05>	/xb9
<Y-acute>	/xba
<LY12>	/xba
<diaeresis>	/xbb
<SD17>	/xbb
<macron>	/xbc
<SM15>	/xbc
<right-square-bracket>	/xbd
<SM08>	/xbd
<acute>	/xbe
<SD11>	/xbe
<multiply>	/xbf
<SA07>	/xbf
<left-brace>	/xc0
<left-curly-bracket>	/xc0
<SM11>	/xc0

*Charmap file (Part 5 of 6)*



```

<A> /xc1
<LA02> /xc1
<B> /xc2
<LB02> /xc2
<C> /xc3
<LC02> /xc3
<D> /xc4
<LD02> /xc4
<E> /xc5
<LE02> /xc5
<F> /xc6
<LF02> /xc6
<G> /xc7
<LG02> /xc7
<H> /xc8
<LH02> /xc8
<I> /xc9
<LI02> /xc9
<syllable-hyphen> /xca
<SP32> /xca
<o-circumflex> /xcb
<L015> /xcb
<o-diaeresis> /xcc
<L017> /xcc
<o-grave> /xcd
<L013> /xcd
<o-acute> /xce
<L011> /xce
<o-tilde> /xcf
<L019> /xcf
<right-brace> /xd0
<right-curly-bracket> /xd0
<SM14> /xd0
<J> /xd1
<LJ02> /xd1
<K> /xd2
<LK02> /xd2
<L> /xd3
<LL02> /xd3
<M> /xd4
<LM02> /xd4
<N> /xd5
<LN02> /xd5
<O> /xd6
<LO02> /xd6
<P> /xd7
<LP02> /xd7
<Q> /xd8
<LQ02> /xd8
<R> /xd9
<LR02> /xd9
<one-superior> /xda
<ND011> /xda
<u-circumflex> /xdb
<LU15> /xdb
<u-diaeresis> /xdc
<LU17> /xdc
<U-grave> /xfd
<LU14> /xfd
<U-acute> /xfe
<LU12> /xfe
<eo> /xff
END CHARMAP

CHARSETID
<NUL>...<SUB> 0
<space>...<U-acute> 1
END CHARSETID

```

*Charmap file (Part 6 of 6)*

---

## Locale definition source file

Figure 277 on page 1127 shows the typical locale definition file that represents the cultural and language conventions in the United States of America. For this example (LC\_COLLATE), note the following:

- The digits (0...9) sort before the letters.
- Upper case and lowercase letters have the same primary sorting weight.

- For each letter, the uppercase letter sorts before the equivalent lowercase letter.

```

escape_char /
comment-char %

#####
LC_CTYPE
#####

upper <A>;<B>;<C>;<D>;<E>;<F>;<G>;<H>;<I>;<J>;<K>;<L>;<M>;/
<N>;<O>;<P>;<Q>;<R>;<S>;<T>;<U>;<V>;<W>;<X>;<Y>;<Z>

lower <a>;<b>;<c>;<d>;<e>;<f>;<g>;<h>;<i>;<j>;<k>;<l>;<m>;/
<n>;<o>;<p>;<q>;<r>;<s>;<t>;<u>;<v>;<w>;<x>;<y>;<z>

space <tab>;<newline>;<vertical-tab>;<form-feed>;/
<carriage-return>;<space>

cntrl <alert>;<backspace>;<tab>;<newline>;<vertical-tab>;/
<form-feed>;<carriage-return>;<NUL>;<SOH>;<STX>;/
<ETX>;<SEL>;<RNL>;<DEL>;<GE>;<SPS>;<RPT>;<SI>;<SO>;<DLE>;<DC1>;/
<DC2>;<DC3>;<RES>;<POC>;<CAN>;<EM>;<UBS>;<CU1>;<IFS>;/
<IGS>;<IRS>;<ITB>;<DS>;<SOS>;<fcs>;<WUS>;<BYP>;<LF>;/
<ETB>;<ESC>;<SA>;<SM>;<CSP>;<MFA>;<ENQ>;<ACK>;/
<SYN>;<IR>;<PP>;<TRN>;<NBS>;<EOT>;<SBS>;<IT>;<RFF>;/
<CU3>;<DC4>;<NAK>;<SUB>

punct <exclamation-mark>;<quotation-mark>;<number-sign>;<dollar-sign>;/
<percent-sign>;<ampersand>;<apostrophe>;<left-parenthesis>;/
<right-parenthesis>;<asterisk>;<plus-sign>;<comma>;/
<hyphen-minus>;<period>;<slash>;<colon>;<semicolon>;/
<less-than-sign>;<equals-sign>;<greater-than-sign>;/
<question-mark>;<commercial-at>;<left-square-bracket>;/
<backslash>;<right-square-bracket>;<circumflex>;/
<underscore>;<grave-accent>;<left-curly-bracket>;/
<vertical-line>;<right-curly-bracket>;<tilde>

digit <zero>;<one>;<two>;<three>;<four>;/
<five>;<six>;<seven>;<eight>;<nine>

xdigit <zero>;<one>;<two>;<three>;<four>;/
<five>;<six>;<seven>;<eight>;<nine>;/
<A>;<B>;<C>;<D>;<E>;<F>;/
<a>;<b>;<c>;<d>;<e>;<f>

blank <space>;<tab>

END LC_CTYPE

#####
LC_COLLATE
#####

order_start forward;forward

<NUL>
...
<SUB>
<space>
<exclamation-mark>
<quotation-mark>
<number-sign>
<dollar-sign>
<percent-sign>

```

*Example locale definition source file (Part 1 of 5)*

*Figure 277. Example locale definition source file*

```

<ampersand>
<apostrophe>
<left-parenthesis>
<right-parenthesis>
<asterisk>
<plus-sign>
<comma>
<hyphen-minus>
<period>
<slash>
<zero>
...
<nine>
<colon>
<semicolon>
<less-than-sign>
<equals-sign>
<greater-than-sign>
<question-mark>
<commercial-at>
<A> <A>; <A>
<B> <B>; <B>
<C> <C>; <C>
<D> <D>; <D>
<E> <E>; <E>
<F> <F>; <F>
<G> <G>; <G>
<H> <H>; <H>
<I> <I>; <I>
<J> <J>; <J>
<K> <K>; <K>
<L> <L>; <L>
<M> <M>; <M>
<N> <N>; <N>
<O> <O>; <O>
<P> <P>; <P>
<Q> <Q>; <Q>
<R> <R>; <R>
<S> <S>; <S>
<T> <T>; <T>
<U> <U>; <U>
<V> <V>; <V>
<W> <W>; <W>
<X> <X>; <X>
<Y> <Y>; <Y>
<Z> <Z>; <Z>
<left-square-bracket>
<backslash>
<right-square-bracket>
<circumflex>
<underscore>
<grave-accent>
<a> <A>; <a>
<b> <B>; <b>
<c> <C>; <c>
<d> <D>; <d>
<e> <E>; <e>
<f> <F>; <f>
<g> <G>; <g>
<h> <H>; <h>
<i> <I>; <i>
<j> <J>; <j>
<k> <K>; <k>
<l> <L>; <l>
<m> <M>; <m>
<n> <N>; <n>
<o> <O>; <o>
<p> <P>; <p>
<q> <Q>; <q>
<r> <R>; <r>
<s> <S>; <s>
<t> <T>; <t>
<u> <U>; <u>
<v> <V>; <v>

```

*Example locale definition source file (Part 2 of 5)*

```

<w> <W>;<w>
<x> <X>;<x>
<y> <Y>;<y>
<z> <Z>;<z>
UNDEFINED
order_end

END LC_COLLATE

#####
LC_MONETARY
#####

int_curr_symbol    "<U><S><D><space>"
currency_symbol   "<dollar-sign>"
mon_decimal_point "<period>"
mon_thousands_sep "<comma>"
mon_grouping       "3;0"
positive_sign      ""
negative_sign      "<hyphen-minus>"
int_frac_digits    2
frac_digits        2
p_cs_precedes      1
p_sep_by_space     0
n_cs_precedes      1
n_sep_by_space     0
p_sign_posn        2
n_sign_posn        2
debit_sign         "<D><B>"
credit_sign        "<C><R>"
left_parenthesis   "<left-parenthesis>"
right_parenthesis "<right-parenthesis>"

END LC_MONETARY

#####
LC_NUMERIC
#####

decimal_point      "<period>"
thousands_sep     "<comma>"
grouping           "3;0"

END LC_NUMERIC

```

*Example locale definition source file (Part 3 of 5)*

```

#####
LC_TIME
#####
abday  "<S><u><n>" ; /
        "<M><o><n>" ; /
        "<T><u><e>" ; /
        "<W><e><d>" ; /
        "<T><h><u>" ; /
        "<F><r><i>" ; /
        "<S><a><t>"

day    "<S><u><n><d><a><y>" ; /
        "<M><o><n><d><a><y>" ; /
        "<T><u><e><s><d><a><y>" ; /
        "<W><e><d><n><e><s><d><a><y>" ; /
        "<T><h><u><r><s><d><a><y>" ; /
        "<F><r><i><d><a><y>" ; /
        "<S><a><t><u><r><d><a><y>"

abmon  "<J><a><n>" ; /
        "<F><e><b>" ; /
        "<M><a><r>" ; /
        "<A><p><r>" ; /
        "<M><a><y>" ; /
        "<J><u><n>" ; /
        "<J><u><l>" ; /
        "<A><u><g>" ; /
        "<S><e><p>" ; /
        "<O><c><t>" ; /
        "<N><o><v>" ; /
        "<D><e><c>"

mon    "<J><a><n><u><a><r><y>" ; /
        "<F><e><b><r><u><a><r><y>" ; /
        "<M><a><r><c><h>" ; /
        "<A><p><r><j><l>" ; /
        "<M><a><y>" ; /
        "<J><u><n><e>" ; /
        "<J><u><l><y>" ; /
        "<A><u><g><u><s><t>" ; /
        "<S><e><p><t><e><m><b><e><r>" ; /
        "<O><c><t><o><b><e><r>" ; /
        "<N><o><v><e><m><b><e><r>" ; /
        "<D><e><c><e><m><b><e><r>"

d_t_fmt "%a %b %e %H:%M:%S %Z %Y"

d_fmt   "%m//%d//%y"

t_fmt   "%H:%M:%S"

am_pm   "<A><M>" ; "<P><M>"

END LC_TIME

#####
LC_MESSAGES
#####
yesexpr "<circumflex><left-parenthesis><left-square-bracket><y><Y>/
<right-square-bracket><left-square-bracket><e><E><right-square-bracket>/
<left-square-bracket><s><S><right-square-bracket><vertical-line>/
<left-square-bracket><y><Y><right-square-bracket><right-parenthesis>"
noexpr  "<circumflex><left-parenthesis><left-square-bracket><n><N>/
<right-square-bracket><left-square-bracket><o><O><right-square-bracket>/
<vertical-line><left-square-bracket><n><N><right-square-bracket>/
<right-parenthesis>"

END LC_MESSAGES

```

*Example locale definition source file (Part 4 of 5)*

```

%%%%%%%%%%%%%%%%%%%%%%%%%%%%%%%%%%%%%%%%%%%%%%%%%%%%%%%%%%%%%%%%%%%%%%%%
LC_SYNTAX
%%%%%%%%%%%%%%%%%%%%%%%%%%%%%%%%%%%%%%%%%%%%%%%%%%%%%%%%%%%%%%%%%%%%%%%%

backslash      "<backslash>"
right_brace    "<right-brace>"
left_brace     "<left-brace>"
right_bracket  "<right-square-bracket>"
left_bracket   "<left-square-bracket>"
circumflex     "<circumflex>"
tilde          "<tilde>"
exclamation_mark "<exclamation-mark>"
number_sign    "<number-sign>"
vertical_line   "<vertical-line>"
dollar_sign    "<dollar-sign>"
commercial_at  "<commercial-at>"
grave_accent   "<grave-accent>"

END LC_SYNTAX

%%%%%%%%%%%%%%%%%%%%%%%%%%%%%%%%%%%%%%%%%%%%%%%%%%%%%%%%%%%%%%%%%%%%%%%%
LC_TOD
%%%%%%%%%%%%%%%%%%%%%%%%%%%%%%%%%%%%%%%%%%%%%%%%%%%%%%%%%%%%%%%%%%%%%%%%

timezone_difference +480
timezone_name      "<P><S><T>"
daylight_name     "<P><D><T>"
start_month       0
end_month         0
start_week        0
end_week          0
start_day         0
end_day           0
start_time        0
end_time          0
shift             3600

END LC_TOD

```

*Example locale definition source file (Part 5 of 5)*

---

## Locale method source file

The method source file maps method names to the National Language Support (NLS) subroutines that implement those methods. The method file also specifies the object libraries or DLL side-decks where the implementing subroutines are stored. The methods correspond to those subroutines that require direct access to the data structures representing locale data. Figure 278 on page 1132 shows a typical locale method source file.

---

```

escape_char /
comment_char %

METHODS

mblen      "_mblen_sb_a"
mbtowc     "_mbtowc_isol"
mbstowcs   "_mbstowcs_std_a"
wctomb     "_wctomb_isol"
wcstombs   "_wcstombs_std_a"
wctype     "_wctype_std_a"
wcswidth   "_wcswidth_std_a"
csid       "_csid_std_a"
toupper    "_toupper_std_a"
tolower    "_tolower_std_a"
get_wctype "_get_wctype_std_a"
is_wctype  "_is_wctype_std_a"
strcoll    "_strcoll_std_a"
strxfrm    "_strxfrm_std_a"
wcscoll    "_wcscoll_std_a"
wcsxfrm    "_wcsxfrm_std_a"
regcomp    "_regcomp_std_a"
regex     "_regex_std_a"
regfree    "_regfree_std_a"
regerror   "_regerror_std_a"
strfmon    "_strfmon_std_a"
strftime   "_strftime_std_a"
strptime   "_strptime_std_a"
wcsftime   "_wcsftime_std_a"
wcsid      "_wcsid_std_a"

END METHODS

```

---

*Figure 278. Example locale method source file*

---

## Appendix G. Converting hybrid code to a specific character set

If you are responsible for maintaining all code, including legacy code, for a system that includes hybrid code, you will need to convert the hybrid code to the code page that your compiler expects. For example, your system might expect the APL code page 293. Hybrid code is code in which the data is in the local coded character set, but the program syntax uses IBM-1047 code.

---

### Sample program

Figure 279 shows the contents of sample program CCNGHC1. The sample program CCNGHC1 converts all C syntax from code page IBM-1047 to the coded character set that you specify. Comments, string literals and character constants are left alone.

**Note:** Appendix C, “z/OS XL C/C++ code point mappings,” on page 1089 provides figures that show the first and second nybbles of the hexadecimal digits that comprise the code point mappings for code page IBM-1047 and the APL code page 293.

```
/*
 * CCNGHC1: Sample code to convert all C syntax from code page 1047
 *          to the coded character set the user specifies.
 *          Comments, string literals and character constants are
 *          left alone. The escape character in an escape sequence
 *          is changed, since it is variant.
 *
 * Usage: CCNGHC1 <coded character set>
 *        The input file is read from stdin and the output is written
 *        to stdout.
 *
 * Example: If you want to convert all C syntax, written in coded character set
 *          1047, in a file (test1047.c.a) to coded character set 500, you can
 *          use CCNGHC1 by issuing the following command.
 *
 *          ccnghc1 <test1047.c.a >test1047.gen.a IBM-500
 *
 *          The result will store in "test500 gen a" file.
 */
#include <stdio.h>
#include <stdlib.h>
#include <iconv.h>
#include <errno.h>

enum boolean { false=0, False=0, FALSE=0, true=1, True=1, TRUE=1 };

/*
 * CharState - state that the FSM is in. Initial State is CodeState
 */
enum CharState { CodeState, SQuoteState, DQuoteState, CommentState,
                DBCSState, EscState, EOFState };
```

*Converting hybrid C syntax from code page IBM-1047 (Part 1 of 8)*

*Figure 279. Converting hybrid C syntax from code page IBM-1047*



```

/*
 * CharVal - characters that can change the state of the FSM
 */
enum CharVal { SlashChar='/', SQuoteChar='\'', DQuoteChar='"',
              StarChar='*', SOChar='\x0E', SIChar='\x0F',
              BSlashChar='\\', EOFChar= -1 };
/*
 * XlateTable - type of translation table
 */
typedef iconv_t XlateTable;

static char *Initialize(int argc, char *argv[]);
static int Convert(char *codeset);
static int InitConv(char **inBuff, char **outBuff, int *maxRecSize,
                  char *codeSet, XlateTable *xlateTable);
static void ConvBuff(int start, int end,
                   char *buff, XlateTable xlateTable);
static enum CharVal LookAhead(char *inBuff, char *outBuff,
                             int *recSize, int *curPos,
                             int maxRecSize, int *codeStartPos,
                             enum CharState state,
                             XlateTable xlateTable);
static enum CharVal GetNextChar(char *inBuff, char *outBuff,
                                int *recSize, int maxRecSize,
                                int *curPos, int *codeStartPos,
                                enum CharState state,
                                XlateTable xlateTable);
static int UpdateAndRead(char *inBuff, char *outBuff,
                        int *recSize, int maxRecSize,
                        int codeStartPos, enum CharState state,
                        XlateTable xlateTable);
static int ReadAndCopy(char *inBuff, char *outBuff, int maxRecSize);

#pragma inline(LAST_POS)
#pragma inline(NEXT_TO_LAST_POS)
#pragma inline(LookAhead)
#pragma inline(GetNextChar)
#pragma inline(ConvBuff)
/*
 * Initialize the environment, and if everything is ok, convert input
 */
main(int argc, char *argv[]) {
    char *codeset = Initialize(argc, argv);
    if (codeset == NULL) {
        return(8);
    }
    return(Convert(codeset));
}
/*
 * Check that 1 parameter was specified - the coded character set to convert the
 * the syntax to.
 * Re-open stdin and stdout as binary files for record I/O.
 * Return the code set if everything is ok, NULL otherwise
 */
static char *Initialize(int argc, char *argv[]) {
    if (argc != 2) {
        fprintf(stderr, "Expected %d argument but got %d\n",
              1, argc-1);
        return(NULL);
    }
}

```

*Converting hybrid C syntax from code page IBM-1047 (Part 2 of 8)*

```

    stdin = freopen("", "rb,type=record", stdin);
    stdout= freopen("", "wb,type=record", stdout);
    if (stdin == NULL || stdout == NULL) {
        fprintf(stderr, "Could not re-open standard streams\n");
        return(NULL);
    }

    return(argv[1]);
}

/*
 * Return the last position in a record
 */
static int LAST_POS(int recSize) {
    return(recSize-1);
}

/*
 * Return the next to last position in a record
 */
static int NEXT_TO_LAST_POS(int recSize) {
    return(recSize-2);
}

/*
 * Convert the stdin file using codeset and write to stdout.
 * Set up the translation table.
 * Read the first record and copy it into the output buffer.
 * Go through the FSM, starting in the Code State and leaving
 * when EOFState is reached (End Of File).
 * Close the translation table.
 */
static int Convert(char *codeset) {
    enum CharVal  c;
    int           recSize;
    enum CharState prvState;
    int           rc;
    int           codeStartPos = 0;
    int           curPos      = 0;
    enum boolean  high       = FALSE;
    enum CharState state      = CodeState;

    char *        inBuff;
    char *        outBuff;
    int           maxRecSize;
    XlateTable    xlateTable;

    rc = InitConv(&inBuff, &outBuff, &maxRecSize, codeset, &xlateTable);
    if (rc) {
        if (inBuff) free(inBuff);
        if (outBuff) free(outBuff);
        return(rc);
    }
}

```

*Converting hybrid C syntax from code page IBM-1047 (Part 3 of 8)*

```

recSize = ReadAndCopy(inBuff, outBuff, maxRecSize);

while (state != EOFState) {
    c = GetNextChar(inBuff, outBuff, &recSize, maxRecSize,
                  &curPos, &codeStartPos, state, xlateTable);
    if (c == EOFChar) {
        state = EOFState;
    }
    switch(state) {
        case CodeState:
            switch (c) {
                case BSlashChar:
                    curPos = LAST_POS(recSize);
                    break;
                case SlashChar:
                    if (LookAhead(inBuff, outBuff, &recSize,
                                &curPos, maxRecSize, &codeStartPos,
                                state, xlateTable)
                        == StarChar) {
                        state = CommentState;
                    }
                    break;
                case SQuoteChar:
                    state = SQuoteState;
                    break;
                case DQuoteChar:
                    state = DQuoteState;
                    break;
            }
        }

    if (state != CodeState || curPos == NEXT_TO_LAST_POS(recSize)) {
        if (curPos == NEXT_TO_LAST_POS(recSize)) {
            ++curPos;
        }
        else {
            ConvBuff(codeStartPos, curPos, outBuff, xlateTable);
        }
    }
    break;

    case CommentState:
        switch(c) {
            case BSlashChar:
                curPos = LAST_POS(recSize);
                break;
            case StarChar:
                if (LookAhead(inBuff, outBuff, &recSize,
                            &curPos, maxRecSize, &codeStartPos,
                            state, xlateTable)
                    == SlashChar) {
                    state = CodeState;
                    codeStartPos = curPos;
                }
                break;
        }
    }
    break;
}

```

*Converting hybrid C syntax from code page IBM-1047 (Part 4 of 8)*

```

case DQuoteState:
    switch(c) {
        case DQuoteChar:
            state = CodeState;
            codeStartPos = curPos;
            break;
        case SOChar:
            prvState = state;
            state = DBCSState;
            break;
        case BSlashChar:
            ConvBuff(curPos, curPos, outBuff, xlateTable);
            if (curPos != LAST_POS(recSize)) {
                prvState = state;
                state = EscState;
            }
            break;
    }
    break;

case SQuoteState:
    switch(c) {
        case SQuoteChar:
            state = CodeState;
            codeStartPos = curPos;
            break;
        case SOChar:
            prvState = state;
            state = DBCSState;
            break;
        case BSlashChar:
            ConvBuff(curPos, curPos, outBuff, xlateTable);
            if (curPos != LAST_POS(recSize)) {
                prvState = state;
                state = EscState;
            }
            break;
    }
    break;

case DBCSState:
    high ^= 1; /* TRUE -> FALSE or FALSE -> TRUE */
    if (high && (c == SICChar)) {
        state = prvState;
        high = FALSE;
    }
    break;

case EscState:
    state = prvState; /* really, this is ok */
    break;

case EOFState:
    break;

default:
    fprintf(stderr, "Internal error - ended up in state %d\n",
            state);
    return(16);
} /* end of switch statement */
++curPos;
}

```

*Converting hybrid C syntax from code page IBM-1047 (Part 5 of 8)*

```

    rc = TermConv(inBuff, outBuff, xlateTable);
    return(0);
}

/*
 * Initialize the translation table and allocate the input and
 * output buffers to use.
 * Return 0 if successful.
 */
static int InitConv(char **inBuff, char **outBuff, int *maxRecSize,
                   char *codeset, XlateTable* xlateTable) {

    static char fileNameBuff[FILENAME_MAX+1];
    fldata_t info;
    int rc;

    *outBuff = *inBuff = NULL;

    rc = fldata(stdin, fileNameBuff, &info);
    if (rc) {
        return(rc);
    }

    *maxRecSize = info._maxreclen;
    *inBuff      = malloc(*maxRecSize);
    *outBuff     = malloc(*maxRecSize);

    if ((*xlateTable = iconv_open("IBM-1047",codeset)) == (iconv_t)(-1)) {
        fprintf(stderr,"Cannot open convertor from %s to IBM-1047",codeset);
        return (8);
    }

    return(!inBuff || !outBuff);
}

/*
 * Convert the buffer from start to end using the translation table
 */
static void ConvBuff(int start, int end,
                    char *buff, XlateTable xlateTable) {

    int rc;
    size_t inleft, outleft, org;
    char *inptr, *outptr;

    outleft = inleft = end-start+1;
    inptr = outptr = &buff[start];

    while (1) {
        rc = iconv(xlateTable,&inptr,&inleft,&outptr,&outleft);

        if (rc == -1) {
            switch (errno) {
                /* Skip the invalid character */
                case EILSEQ: if (--inleft == 0) return;
                            ++inptr;
                            ++outptr;
                            --outleft;
                            break;

                default: fprintf(stderr,"iconv() fails with errno = %d\n",errno);
                          exit(8);
            }
        } else
            return;
    }
}

```

*Converting hybrid C syntax from code page IBM-1047 (Part 6 of 8)*

```

/*
 * Look ahead to the next character. If the current position
 * is the last character of the input record, write the current
 * output record and read in the next record.
 * Return the 'character' read, which may be EOF if the end of
 * the file was reached.
 */
static enum CharVal LookAhead(char *inBuff, char *outBuff,
                              int *recSize, int *curPos,
                              int maxRecSize, int *codeStartPos,
                              enum CharState state,
                              XlateTable xlateTable) {

    if (*curPos == LAST_POS(*recSize)) {
        if (UpdateAndRead(inBuff, outBuff, recSize, maxRecSize,
                          *codeStartPos, state, xlateTable)) {
            return(EOFChar);
        }
        *curPos = 0;
        *codeStartPos = 0;
    }
    else {
        (*curPos)++;
    }
    return(inBuff[*curPos]);
}

/*
 * Similar to LookAhead(), but return the current character
 */
static enum CharVal GetNextChar(char *inBuff, char *outBuff,
                                int *recSize, int maxRecSize,
                                int *curPos, int *codeStartPos,
                                enum CharState state,
                                XlateTable xlateTable) {

    if (*curPos > LAST_POS(*recSize)) {
        if (UpdateAndRead(inBuff, outBuff, recSize, maxRecSize,
                          *codeStartPos, state, xlateTable)) {
            return(EOFChar);
        }
        *curPos = 0;
        *codeStartPos = 0;
    }
    return(inBuff[*curPos]);
}

```

*Converting hybrid C syntax from code page IBM-1047 (Part 7 of 8)*

```

/*
 * If the current state is the code state, translate the remaining
 * part of the record.
 * Write out the record to stdout
 * Read in the next record and copy it to the output buffer.
 */
static int UpdateAndRead(char *inBuff, char *outBuff,
                        int *recSize, int maxRecSize,
                        int codeStartPos, enum CharState state,
                        XlateTable xlateTable) {

    if (state == CodeState) {
        ConvBuff(codeStartPos, LAST_POS(*recSize), outBuff, xlateTable);
    }
    fwrite(outBuff, 1, *recSize, stdout);
    *recSize = ReadAndCopy(inBuff, outBuff, maxRecSize);
    return((*recSize == 0) ? 1 : 0);
}

/*
 * Read in a record from stdin and copy it to the output buffer.
 * Return the number of bytes read.
 */
static int ReadAndCopy(char *inBuff, char *outBuff,
                       int maxRecSize) {
    int recSize;

    recSize = fread(inBuff, 1, maxRecSize, stdin);
    if (feof(stdin) && recSize == 0) {
        return(0);
    }
    else {
        memcpy(outBuff, inBuff, recSize);
        return(recSize);
    }
}

/*
 * Free allocated storage and close the translation table.
 */
static int TermConv(char *inBuff,
                   char *outBuff, XlateTable xlateTable) {
    iconv_close(xlateTable);
    free(inBuff);
    free(outBuff);
    return(0);
}

```

*Converting hybrid C syntax from code page IBM-1047 (Part 8 of 8)*

---

## Appendix H. Additional Examples

This chapter contains additional examples that you might find useful when you are writing a C or C++ program.

---

### Memory Management

If you have ever received an error from overwriting storage created with the `malloc()` function, the following code may be of interest. It shows how to use debuggable versions of `malloc()/calloc()/realloc()` and `free()`. You can tailor the following macros.

Figure 280 shows an example program (CCNGMI1) that uses debuggable versions of `malloc()/calloc()/realloc()` and `free()` macros.

---

```
/* debuggable malloc()/calloc()/realloc()/free() example */
/* part 1 of 2-other file is CCNGMI2 */
#ifndef __STORAGE__
#define __STORAGE__

#define PADDING_SIZE      4    /* amount of padding around */
                               /* allocated storage          */
#define PADDING_BYTE     0xFE  /* special value to initialize*/
                               /* padding to                  */
#define HEAP_INIT_SIZE   4096  /* get 4K to start with      */
#define HEAP_INCR_SIZE   4096  /* get 4K increments         */
#define HEAP_OPTS        72    /* HEAP(,ANYWHERE,FREE)     */

extern int heapVerbose;      /* If 0, heap allocation and */
                               /* free messages will be     */
                               /* suppressed, otherwise, they*/
                               /* will be displayed         */
#endif
```

---

*Figure 280. Debuggable malloc()/calloc()/realloc()/free() example*

Figure 281 on page 1142 shows the main routine (CCNGMI2) that calls the preceding macros.



```

/* debuggable malloc()/calloc()/realloc()/free() example */
/* part 2 of 2-other file is CCNGMI1 */
/*
* STORAGE:
*
* EXTERNALS:
*
* This file contains code for the following functions:
* -debug_malloc.....allocate storage from a Language Environment heap
* -debug_calloc.....allocate storage from a Language Environment heap
* and initialize it to 0.
* -debug_realloc....re-allocate storage previously allocated
* by debug_malloc in this file. If a NULL pointer is passed
* instead of a previously allocated pointer,
* debug_malloc will be called directly.
* -debug_free.....free storage previously allocated by debug_malloc
* in this file.
* The prefix 'debug_' make sure these functions don't affect the calls
* to original functions within the libraries a user has no control over.
*
* USAGE:
*
* To use this code, compile with no special options (although the
* DEBUG option is useful so that the trace back will give
* additional information - line number information and the type and
* values of variables will be dumped in a trace back for all
* files compiled with DEBUG).
* Prelink (or link) this text deck with your text decks (make sure
* you explicitly link this text deck - avoid using autocall since
* you might get the C/370 version of malloc/free/realloc).
*
* INTERNALS:
*
* General Algorithm:
*
* When storage is allocated, extra 'padding' is allocated at the
* start and end of the actual storage allocated for the user.
* This padding is then initialized to a special pad value. If the
* user's code is functioning correctly, the padding should not
* have been changed when it comes time to free the storage. If the
* debug_free() routine finds that the padding does not have the correct
* value, the storage about to be freed is dumped and a trace back
* is issued, and then the storage is dumped, as usual.
* The padding size and padding byte value can be modified to suit
* your needs. Update the include file "ccngmi1.h" if you want
* to modify these values.
* Here is a diagram of how storage is allocated (assume that the
* pad value is xFE, the padding size is 4 bytes and 8 bytes of
* storage were requested):
*
* Length of      Padding      Allocated storage      Padding
* storage
* |              |              |              |
* +-----+-----+ +-----+-----+ +-----+-----+ +-----+-----+
* | 00 00 00 10 | FE FE FE FE | xx xx xx xx | xx xx xx xx | FE FE FE FE|
* +-----+-----+ +-----+-----+ +-----+-----+ +-----+-----+
*
* (Values above shown in hexadecimal)
*

```

*Main routine - debuggable malloc()/calloc()/realloc()/free() example (Part 1 of 7)*

*Figure 281. Main routine - debuggable malloc()/calloc()/realloc()/free() example*

```

* This method is fairly effective in tracking down storage
* allocation problems. Also, code does not have
* to be recompiled to use these routines - it just has to be
* relinked. Note that it is not guaranteed to find all storage
* allocation errors - if you overwrite the padding with the
* same value it had before, or you overwrite more storage than
* you had padding for, you will still have problems.
*
* This code uses the LE/370 heap services to allocate, re-allocate
* and free storage. A User Heap is used instead of the library
* heap so that if the heap gets corrupted, the standard library
* services that themselves use the heap won't be affected (i.e.
* if the user heap is damaged, a call to a library function
* such as printf should still succeed).
*
* Notes of interest:
* - The runtime option STORAGE is very useful for tracking down
*   random pointer problems - it initializes heap and/or stack frame
*   storage to a particular value.
* - The runtime option RPTSTG(ON) is useful for improving heap and
*   stack frame allocation - it generates a report indicating how
*   stack and heap storage was managed for a given program.
*/
#include "ccngmil.h"
#include <leawi.h>
#include <stdio.h>

/*
 * heapVerbose: external variable that controls whether heap
 *               allocation and free messages are displayed.
 */
int heapVerbose=1;

/*
 * mallocHeapID: static variable that is the Heap ID used for allocating
 *               storage via debug_malloc().
 *               On the first call to debug_malloc(), a Heap will be created
 *               and this Heap ID will be set.
 *               All subsequent calls to debug_malloc will use this Heap ID.
 */
static _INT4 mallocHeapID=0;
/*
 * CHARS_PER_LINE/BYTES_PER_LINE: Used by dump() and DumpLine()
 *                               to control the width of a storage dump.
 */
#define CHARS_PER_LINE      40
#define BYTES_PER_LINE     16

/*
 * align: Given a value and the alignment desired (in bits), round
 *        the value to the next largest alignment, unless it is
 *        already aligned, in which case, just return the value passed.
 */
#pragma inline(align)

static int align(int value, int shift) {
    int alignment = (0x1 << shift);

    if (value % alignment) {
        return(((value >> shift) << shift) + alignment);
    }
    else {
        return(value);
    }
}

```

*Main routine - debuggable malloc()/calloc()/realloc()/free() example (Part 2 of 7)*

```

/*
 * padding: given a buffer (address and length), return 1 if the
 *           entire buffer consists of the pad character specified,
 *           otherwise return 0.
 */
#pragma inline(padding)
static int padding(const char* buffer, long size, int pad) {
    int i;
    for (i=0;i<size;++i) {
        if (buffer??(i??) != pad) return(0);
    }
    return(1);
}
/*
 * CEEComp: Given two feedback codes, return 0 if they have the same
 *           message number and facility id, otherwise return 1.
 */
#pragma inline(CEECmp)
static int CEEComp(_FEEDBACK* fc1, _FEEDBACK* fc2) {

    if (fc1->tok_msgno == fc2->tok_msgno &&
        !memcmp(fc1->tok_facid, fc2->tok_facid,
                sizeof(fc1->tok_facid))) {
        return(0);
    }
    else {
        return(1);
    }
}
/*
 * CEEOk: Given a feedback code, return 1 if it compares the same
 *        condition code CEE000.
 */
#pragma inline(CEEOk)
static int CEEOk(_FEEDBACK* fc) {
    _FEEDBACK CEE000 = { 0, 0, 0, 0, 0, {0,0,0}, 0 };

    return(CEECmp(fc, &CEE000) == 0);
}

/*
 * CEEErr: Given a title string and a feedback code, print the
 *         title to stderr, then print the message associated
 *         with the feedback code. If the feedback code message can
 *         not be printed out, print out the message number and severity.
 */
static void CEEErr(const char* title, _FEEDBACK* fc) {
    _FEEDBACK msgFC;
    _INT4 dest = 2;

    fprintf(stderr, "\n%s\n", title);
    CEEMSG(fc, &dest, &msgFC);

    if (!CEEOk(&msgFC)); {
        fprintf(stderr, "Message number:%d with severity %d occurred\n",
                fc->tok_msgno, fc->tok_sev);
    }
}

```

*Main routine - debuggable malloc()/calloc()/realloc()/free() example (Part 3 of 7)*

```

/*
 * DumpLine: Dump out a buffer (address and length) to stderr.
 */
static void DumpLine(char* address, int length) {
    int i, c, charCount=0;

    if (length % 4) length += 4;

    fprintf(stderr, "%8.8p: ", address);
    for (i=0; i < length/4; ++i) {
        fprintf(stderr, "%8.8X ", ((int*)address)??(i??));
        charCount += 9;
    }
    for (i=charCount; i < CHARS_PER_LINE; ++i) {
        putc(' ', stderr);
    }
    fprintf(stderr, "| ");
    for (i=0; i < length; ++i) {
        c = address??(i??);
        c = (isprint(c) ? c : '.');
        fprintf(stderr, "%c", c);
    }
    fprintf(stderr, "\n");
}
/*
 * dump: dump out a buffer (address and length) to stderr by dumping out
 *       a line at a time (DumpLine), until the buffer is written out.
 */
static void dump(void* generalAddress, int length){
    int curr = 0;
    char* address = (char*) generalAddress;

    while (&address??(curr??) <&address??(length-BYTES_PER_LINE??)) {
        DumpLine(&address??(curr??), BYTES_PER_LINE);
        curr += BYTES_PER_LINE;
    }
    if (curr < length) {
        DumpLine(&address??(curr??), length-curr);
    }
}
/*
 * debug_malloc: Create a heap if necessary by calling CEECRHP. This only
 *               needs to be done on the first call to debug_malloc(). Verify
 *               that the heap creation was ok. If it wasn't, issue an
 *               error message and return a NULL pointer.
 *               Write a message to stderr indicating how many bytes
 *               are about to be allocated.
 *               Call CEEGTST to allocate the storage requested plus
 *               additional padding to be placed at the start and end
 *               of the allocated storage. Verify that the storage allocation
 *               was successful. If it wasn't, issue an error message and
 *               return a NULL pointer.
 *               Write a message to stderr indicating the address of the
 *               allocated storage.
 *               Initialize the padding to the value of PADDING_BYTE, so that
 *               debug_free() will be able to test that the padding was not changed.
 *               Return the address of the allocated storage (starting after
 *               the padding bytes).
 */

void* debug_malloc(long initSize) {
    _FEEDBACK fc;
    _POINTER address=0;

```

*Main routine - debuggable malloc()/calloc()/realloc()/free() example (Part 4 of 7)*

```

long totSize;
long* lenPtr;
char* msg;
char* start;
char* end;

if (!mallocHeapID) {
    _INT4 heapSize = HEAP_INIT_SIZE;
    _INT4 heapInc = HEAP_INCR_SIZE;
    _INT4 opts = HEAP_OPTS;

    CEECRHP(&mallocHeapID, &heapSize, &heapInc, &opts, &fc);
    if (!CEEOK(&fc)) {
        CEEErr("Heap creation failed", &fc);
        return(0);
    }
}
if (heapVerbose) {
    fprintf(stderr, "Allocate %d bytes", initSize);
}
/*
 * Add the padding size to the total size, then round up to the
 * nearest double word
 */
totSize = initSize + (PADDING_SIZE*2) + sizeof(long);
totSize = align(totSize, 3);

CEEGTST(&mallocHeapID, &totSize, &address, &fc);
if (!CEEOK(&fc)) {
    msg = "Storage request failed";
    CEEErr(msg, &fc);
    __ctrace(msg);

    return(0);
}
lenPtr = (long*) address;
*lenPtr = initSize;
start = ((char*) address) + sizeof(long);
end = start + initSize + PADDING_SIZE;
memset(start, PADDING_BYTE, PADDING_SIZE);
memset(end, PADDING_BYTE, PADDING_SIZE);

if (heapVerbose) {
    fprintf(stderr, " starting at address %p\n", address);
}

return(start + PADDING_SIZE);
}
/*
 * debug_calloc: Call debug_malloc() to allocate the requested amount
 * of storage. If the allocation was successful,
 * initialize the allocated storage to 0.
 * Return the address of the allocated storage (or a NULL
 * pointer if debug_malloc returned a NULL pointer).
 */
void* debug_calloc(size_t num, size_t size) {
    size_t initSize = num * size;
    void* ptr;
    ptr = debug_malloc(initSize);
    if (ptr) {
        memset(ptr, 0, initSize);
    }
    return(ptr);
}

```

*Main routine - debuggable malloc()/calloc()/realloc()/free() example (Part 5 of 7)*

```

/*
 * debug_realloc: If a NULL pointer is passed, call debug_malloc() directly.
 * Call CEECZST to re-allocate the storage requested plus
 * additional padding to be placed at the start and end
 * of the allocated storage.
 * Verify that the storage re-allocation was ok. If it wasn't,
 * issue an error message, dump the storage, and return a NULL
 * pointer.
 * Write a message to stderr indicating the address of the
 * re-allocated storage.
 * Initialize the padding to the value of PADDING_BYTE, so
 * that debug_free() will be able to test that the padding was not
 * changed. Note that the padding at the start of the storage
 * does not need to be allocated, since it was already
 * initialized by an earlier call to debug_malloc().
 * Return the address of the re-allocated storage (starting
 * after the padding bytes).
 */

void* debug_realloc(char* ptr, long initSize) {
    _FEEDBACK fc;
    _POINTER address = (ptr - sizeof(long) - PADDING_SIZE);

    long oldSize;
    long* lenPtr;
    char* start;
    char* end;
    char* msg;
    long newSize = initSize;

    if (ptr == 0) {
        return(debug_malloc(newSize));
    }

    oldSize = *((long*) address);

    if (heapVerbose) {
        fprintf(stderr, "Re-allocate %d bytes from address %p to ",
            newSize, address);
    }

    /*
     * Add the padding size to the total size, then round up to the
     * nearest double word
     */

    newSize += (PADDING_SIZE*2) + sizeof(long);
    newSize = align(newSize, 3);
    CEECZST(&address, &newSize, &fc);
    if (!CEEOk(&fc)) {
        msg = "Storage re-allocation failed";

        CEEErr(msg, &fc);
        dump(address, oldSize + (PADDING_SIZE*2) + sizeof(long));
        __ctrace(msg);
        return(0);
    }

    lenPtr = (long*) address;
    *lenPtr = initSize;
    start = ((char*) address) + sizeof(long);
    end = start + initSize + PADDING_SIZE;

    memset(end, PADDING_BYTE, PADDING_SIZE);
    if (heapVerbose) {
        fprintf(stderr, "address %p\n", address);
    }
}

```

*Main routine - debuggable malloc()/calloc()/realloc()/free() example (Part 6 of 7)*

```

    return(start + PADDING_SIZE);
}
/*
 * debug_free: Calculate where the start and end of the originally
 * allocated storage was. The start will be different than the
 * address passed in because the address passed in points after
 * the padding bytes added by debug_malloc() or debug_realloc().
 * Write a message to stderr indicating what address is about
 * to be freed.
 * Verify that the start and end padding bytes have the original
 * padding value. If they don't, dump out the originally
 * allocated storage and issue a trace.
 * Free the storage by calling CEEFRST. If the storage free
 * fails, dump out the storage and issue a trace.
 */
void debug_free(char* ptr) {
    _FEEDBACK fc;
    _POINTER address=(void*) (ptr - sizeof(long) - PADDING_SIZE);
    char* start;
    char* end;
    long size;
    long* lenPtr;
    char* msg;
    lenPtr = (long*) address;
    size = *lenPtr;
    start = ((char*) address) + sizeof(long);
    end = start + size + PADDING_SIZE;

    if (heapVerbose) {
        fprintf(stderr, "Free address %p\n", address);
    }
    if (!padding(start, PADDING_SIZE, PADDING_BYTE) ||
        !padding(end, PADDING_SIZE, PADDING_BYTE)) {

        dump(address, size + (PADDING_SIZE*2) + sizeof(long));
        msg = "Padding overwritten";
        __ctrace(msg);
    }
    else {
        CEEFRST(&address, &fc);
        if (!CEEOk(&fc)) {
            msg = "Storage debug_free failed";

            CEEErr(msg, &fc);
            dump(address, size + (PADDING_SIZE*2) + sizeof(long));
            __ctrace(msg);
        }
    }
}
}

```

*Main routine - debuggable malloc()/calloc()/realloc()/free() example (Part 7 of 7)*

---

## Calling MVS WTO routines from C

The following examples call a function that will perform a Write To Operator (WTO) call. You can tailor it as you wish. The C code performs an ILC to an assembler routine to do a dynamic WTO call. To use this example, you would perform the following steps; when complete, information is then written to the job log.

1. Assemble the code shown in Figure 282 on page 1149
2. Compile the code shown in Figure 283 on page 1150
3. Link the two together
4. Run CCNGWT2

**Note:** This example runs only in the TSO BATCH environment.

Figure 282 on page 1149 shows sample program CCNGWT1, which performs a WTO call.

```

* WRITE TO OPERATOR EXAMPLE *
* PART 1 OF 2-OTHER FILE IS CCNGWT2 *
WTO      CSECT
WTO      AMODE 31
WTO      RMODE ANY

*****
* R1->ADDRESS OF INTEGER -> LENGTH OF STRING
*   ->CHARACTER STRING

          EDCPRLG DSALEN=DLEN
          USING DSA,13
*****
* RANGE CHECK LENGTH
* IGNORE A SINGLE TRAILING NULL CHARACTER

          L      5,0(,1)      POINT TO LENGTH
          LA     15,4         RETURN CODE FOR INVALID LENGTH
          ICM    5,B'1111',0(5) LENGTH OF MESSAGE
          BNP    RETURN      NOT >0? RETURN
          L      6,4(,1)      POINT TO MESSAGE
          LA     8,0(5,6)     POINT TO CHAR AFTER MESSAGE
          BCTR   8,0         POINT TO LAST CHARACTER
          CLI    0(8),0      IS IT A NULL CHARACTER?
          BNE    NOENDINGNULL
          BCT    5,NOENDINGNULL IGNORE IT: USER SAID WTO(SIZEOF S,S)
          B      RETURN      UNLESS LENGTH WAS DROPPED TO ZERO
NOENDINGNULL DS 0H
          LA     7,0         LENGTH OK SO FAR
          LA     8,L'BUFFER   MAXIMUM LENGTH
          CR     5,8         CHECK LENGTH
          BNH    LENOK
          LR     5,8         SHOW ONLY WHAT FITS INTO BUFFER
          LA     7,4         REMEMBER SPECIFIED STRING WAS TOO LONG
LENOK      DS      0H

*****
* BUILD WTO BUFFER
* COPY LIST FORM OF WTO TO DSA
* EXECUTE WTO

          STH    5,PREFIX     LENGTH SHOWN GOES INTO PREFIX
          BCTR   5,0         REDUCE LENGTH FOR EXECUTE
          EX     5,MSG        MOVE MESSAGE TEXT
          LA     6,PREFIX     POINT TO PREFIX OF COPIED MESSAGE
          MVC    WTOD,WTOL    MOVE LIST FORM OF MACRO TO DSA
          WTO    TEXT=(6),MF=(E,WTOD)

```

*Performing a Write To Operator (Part 1 of 2)*

*Figure 282. Performing a Write To Operator*



```

*****
* IF WTO RETURNED NON-ZERO THAT'S THE RETURN CODE FOR THE USER
* OTHERWISE WE RETURN 4 IF WE TRUNCATED MESSAGE, 0 IF WE DIDN'T

          LTR  15,15          CHECK RC FROM WTO
          BNZ  RETURN        0 WTO RC RETURNED TO CALLER
          LR   15,7          TELL CALLER IF STRING WAS TOO LONG
RETURN    DS   0H
          EDCEPIL
MSG       MVC  BUFFER(*-*),0(6)
WTOL      WTO  TEXT=,ROUTCDE=11,DESC=12,MF=L      LIST FORM
WTOLEN    EQU  *-WTOL                          LENGTH TO MOVE
DSA       EDCCDSAD
          DS   0F
WTOD      DS   CL(WTOLEN)
PREFIX    DS   H
BUFFER    DS   CL126
DLEN      EQU  *-DSA
          END

```

### *Performing a Write To Operator (Part 2 of 2)*

Figure 283 shows the program (CCNGWT2) you would run after you compile the code shown in Figure 282 on page 1149.

---

```

/* write to operator example */
/* part 2 of 2-other file is CCNGWT1 */
#pragma linkage(WTO,os_upstack)
int WTO(int,char*);

int main(void) {
    #define msg "my message"
    WTO(sizeof msg-1,msg);
}

```

---

*Figure 283. Performing a Write To Operator*

## Listing Partitioned Data Set Members

This section contains code examples that demonstrate how you can create a list of all members in a Partitioned Data Set (PDS). Figure 284 on page 1151 shows the main routine (called CCNGIP1) and Figure 285 on page 1154 (CCNGIP2) is the associated header file.

**Note:** This information is included to aid you in such a task and is **not** programming interface information.

```

/* this example shows how to create a list of members of a PDS */
/* part 1 of 2-other file is CCNGIP2 */
/*
 * NODE_PTR pds_mem(const char *pds):
 * pds must be a fully qualified pds name, for example,
 * ID.PDS.DATASET * returns a * pointer to a linked list of
 * nodes. Each node contains a member of the * pds and a
 * pointer to the next node. If no members exist, the pointer
 * is NULL.
 *
 * Note: Behavior is undefined if pds is the name of a sequential file.
 */

#include <stdio.h>
#include <string.h>
#include <stdlib.h>
#include "ccngip2.h"

/*
 * RECORD: each record of a pds will be read into one of these structures.
 * The first 2 bytes is the record length, which is put into 'count',
 * the remaining 254 bytes are put into rest. Each record is 256 bytes long.
 */

#define RECLLEN 254

typedef struct {
    unsigned short int count;
    char rest[RECLLEN];
} RECORD;

/* Local function prototypes */

static int gen_node(NODE_PTR *node, RECORD *rec, NODE_PTR *last_ptr);
static char *add_name(NODE_PTR *node, char *name, NODE_PTR *last_ptr);

NODE_PTR pds_mem(const char *pds) {
    FILE *fp;
    int bytes;
    NODE_PTR node, last_ptr;
    RECORD rec;
    int list_end;
    char *qual_pds;

    node = NULL;
    last_ptr = NULL;

    /*
     * Allocate a new variable, qual_pds, which will be the same as pds, except
     * with single quotes around it, i.e. ID.PDS.DATASET ==> 'ID.PDS.DATA SET'
     */

    qual_pds = (char *)malloc(strlen(pds) + 3);
    if (qual_pds == NULL) {
        fprintf(stderr, "malloc failed for %d bytes\n", strlen(pds) + 3);
        exit(-1);
    }
    sprintf(qual_pds, "%s'", pds);
}

```

*Example of Listing All Members of a PDS (Part 1 of 4)*

*Figure 284. Example of Listing All Members of a PDS*

```

/*
 * Open the pds in binary read mode. The PDS directory will be read
one
 * record at a time until either the end of the directory or end-of-file
 * is detected. Call up gen_node() with every record read, to add
member
 * names to the linked list
 */

fp = fopen(qual_pds,"rb");
if (fp == NULL)
    return(NULL);

do
{
    bytes = fread(&rec, 1, sizeof(rec), fp);
    if ((bytes != sizeof(rec)) && !feof(fp)) {
        perror("FREAD:");
        fprintf(stderr,"Failed in %s, line %d\n"
            "Expected to read %d bytes but read %d bytes\n",
            __FILE__,__LINE__,sizeof(rec), bytes);
        exit(-1);
    }

    list_end = gen_node(&node,&rec, &last_ptr);

} while (!feof(fp) && !list_end);
fclose(fp);
free(qual_pds);
return(node);
}
/*
 * GEN_NODE() processes the record passed. The main loop scans through
the
 * record until it has read at least rec->count bytes, or a directory
end
 * marker is detected.
 *
 * Each record has the form:
 *
 * +-----+-----+-----+-----+-----+
 * + # of bytes |Member|Member|.....|Member| Unused      +
 * + in record  | 1    | 2    |     |  n    |              +
 * +-----+-----+-----+-----+-----+
 * + |--count---|-----rest-----|
 * + (Note that the number stored in count includes its own
 * + two bytes)
 *
 * And, each member has the form:
 *
 * +-----+-----+-----+-----+
 * + Member |TTR   |info|
 * + Name   |     |byte| User Data TTRN's (halfwords) +
 * + 8 bytes|3 bytes|   |
 * +-----+-----+-----+-----+
 */
#define TTRLEN 3      /* The TTR's are 3 bytes long */

/*
 * bit 0 of the info-byte is '1' if the member is an alias,
 * 0 otherwise. ALIAS_MASK is used to extract this information
 */

```

*Example of Listing All Members of a PDS (Part 2 of 4)*

```

#define ALIAS_MASK ((unsigned int) 0x80)

/*
 * The number of user data half-words is in bits 3-7 of the info byte.
 * SKIP_MASK is used to extract this information. Since this number
 * is
 * in half-words, it needs to be double to obtain the number of bytes.
 */
#define SKIP_MASK ((unsigned int) 0x1F)

/*
 * 8 hex FF's mark the end of the directory
 */

char *endmark = "\xFF\xFF\xFF\xFF\xFF\xFF\xFF\xFF";
static int gen_node(NODE_PTR *node, RECORD *rec, NODE_PTR *last_ptr) {

    char *ptr, *name;
    int skip, count = 2;
    unsigned int info_byte, alias, ttrn;
    char ttr[TTRLEN];
    int list_end = 0;

    ptr = rec->rest;

    while(count < rec->count) {
        if (!memcmp(ptr,endmark,NAMELEN)) {
            list_end = 1;
            break;
        }

        /* member name */
        name = ptr;
        ptr += NAMELEN;

        /* ttr */
        memcpy(ttr,ptr,TTRLEN);
        ptr += TTRLEN;

        /* info_byte */
        info_byte = (unsigned int) (*ptr);
        alias = info_byte & ALIAS_MASK;
        if (!alias) add_name(node,name,last_ptr);
        skip = (info_byte & SKIP_MASK) * 2 + 1;
        ptr += skip;
        count += (TTRLEN + NAMELEN + skip);
    }
    return(list_end);
}
/*
 * ADD_NAME: Add a new member name to the linked node. The new member is
 * added to the end so that the original ordering is maintained.
 */

static char *add_name(NODE_PTR *node, char *name, NODE_PTR *last_ptr) {

    NODE_PTR newnode;

    /*
     * malloc space for the new node
     */

    newnode = (NODE_PTR)malloc(sizeof(NODE));
    if (newnode == NULL) {
        fprintf(stderr,"malloc failed for %d bytes\n",sizeof(NODE));
        exit(-1);
    }
}

```

*Example of Listing All Members of a PDS (Part 3 of 4)*

```

/* copy the name into the node and NULL terminate it */
memcpy(newnode->name,name,NAMELEN);
newnode->name[NAMELEN] = '\0';
newnode->next = NULL;

/*
 * add the new node to the linked list
 */
if (*last_ptr != NULL) {
    (*last_ptr)->next = newnode;
    *last_ptr = newnode;
}
else {
    *node = newnode;
    *last_ptr = newnode;
}
return(newnode->name);
}
/*
 * FREE_MEM: This function is not used by pds_mem(), but it should be used
 * as soon as you are finished using the linked list. It frees the storage
 * allocated by the linked list.
 */
void free_mem(NODE_PTR node) {
    NODE_PTR next_node=node;

    while (next_node != NULL) {
        next_node = node->next;
        free(node);
        node = next_node;
    }
    return;
}

```

*Example of Listing All Members of a PDS (Part 4 of 4)*

Figure 285 (CCNGIP2) shows the associated header file.

---

```

/* this example shows how to create a list of members of a PDS */
/* part 2 of 2-other file is CCNGIP1 */
/*
 * NODE: a pointer to this structure is returned from the call to pds_mem().
 * It is a linked list of character arrays - each array contains a member
 * name. Each next pointer points * to the next member, except the last
 * next member which points to NULL.
 */

#define NAMELEN 8      /* Length of a MVS member name */

typedef struct node {
    struct node *next;
    char name[NAMELEN+1];
} NODE, *NODE_PTR;

NODE_PTR pds_mem(const char *pds);
void free_mem(NODE_PTR list);

```

---

*Figure 285. ccngip2.h Header file*

---

## Appendix I. Application considerations for z/OS UNIX XL C/C++

This appendix briefly describes the extent of z/OS XL C/C++ support available for traditional MVS programming environments when you are using z/OS UNIX.

---

### Relationship to DB2 universal database

No explicit support for DB2 programs exists for POSIX.1 implementation. DB2 z/OS XL C/C++ programs must be processed by a DB2 precompile step to replace Structured Query Language (SQL) statements with z/OS XL C/C++ functions. The precompilation step accepts only MVS data set I/O.

It is possible that an existing DB2 z/OS XL C/C++ application program can be changed to add POSIX.1-defined I/O functions to access data in z/OS UNIX files. IBM, however, does not explicitly support this access. It is also possible that you can write a new POSIX.1-conforming z/OS XL C/C++ application program that access DB2 data by calling non-POSIX.1-conforming DB2 programs. IBM, however, does not explicitly support this either.

---

### Application programming environments not supported

The following MVS programming environments are not supported for use when developing POSIX.1 z/OS XL C/C++ application programs. Application programs that attempt to take advantage of these environments will not work as intended.

- CICS
- IMS file system

---

### Support for the Curses library

The Curses library provides a set of functions that enable you to manipulate a terminal's display regardless of the terminal type. Using this structure, you can manipulate data on a terminal's display. You can instruct curses to treat the entire terminal display as one large window or you can create multiple windows on the display. The windows can be different sizes and can overlap one another.

Each window on a terminal's display has its own window data structure. This structure keeps state information about the window such as its size and where it is located on the display. Curses uses the window data structure to obtain relevant information it needs to carry out your instructions.

The Curses archive file resides in `/usr/lib`. The name of the Curses archive file is `libcurses.a`; this file is used for all applications: base 31-bit, XPLINK 31-bit, and 64-bit. The following is an example of compiling `test.c` with the Curses archive using XPLINK:

```
c89 -o test -Wc,xplink -Wl,xplink test.c -lcurses
```

The following is an example of compiling `test.c` with the Curses archive for a 64-bit application:

```
c89 -o test -Wc,lp64 -Wl,lp64 test.c -lcurses
```

For more information about curses, refer to the *z/OS C Curses* manual.

---

## Appendix J. External variables

The POSIX 1003.1 and X/Open CAE Specification 4.2 (XPG4.2) require that the C system header files define certain external variables. Additional variables are defined for use with POSIX or XPG4.2 functions. If you define one of the POSIX or XPG4 feature test macros and include one of these headers, the external variables will be defined in your program. These external variables are treated differently than other global variables in a multithreaded environment (values are thread-specific) and across a call to a fetched module (values are propagated). To access the global variable values (not thread specific), either C with the RENT compiler option or C++ must be used, and the SCEEOBJ autocall library must be specified during the z/OS bind. The SCEEOBJ library must be specified before the SCEELKEX and the SCEELKED libraries. If the SCEEOBJ library is not specified first, then Language Environment cannot find the external variables. Although there are no linker/binder errors or warnings, runtime errors can occur. Functions to access the thread-specific values of these variables are provided for use in a multithreaded environment.

For a dynamically called DLL module to share access to the POSIX external variables with its caller, the DLL module must define the `_SHARE_EXT_VARS` feature test macro. This is implemented in the current Language Environment runtime. For more information, see the section on feature test macros in *z/OS XL C/C++ Runtime Library Reference*.

When compiling code with the XPLINK or LP64 compiler options, all access to these external variables is resolved by dynamic linkage, using `IMPORT` control statements in the `CELHS003` (`CELQS003`) member of the `SCEELIB` library. The `SCEEOBJ` library cannot be used when binding XPLINK executable modules. Because of this, the `_SHARE_EXT_VARS` (and subordinate) feature test macros need only be used with XPLINK to access the thread-specific values of these external variables without the explicit use of the thread-specific functions.

For more information on the header files referred to in the following sections, see *z/OS XL C/C++ Runtime Library Reference*.

---

### errno

When a runtime library function is not successful, the function may do any of the following to identify the error:

- Set `errno` to a documented value.
- Set `errno` to a value that is not documented. You can use `strerror()` or `perror()` to get the message associated with the `errno`.
- Not set `errno`.
- Clear `errno`.

See also `errno.h`.



---

## daylight

The daylight savings time flag set by `tzset()`. Note that other time zone sensitive functions such as `ctime()`, `localtime()`, `mktime()`, and `strptime()` implicitly call `tzset()`. Use the `__dlight()` function to access the thread-specific value of `daylight`. See also `time.h`.

---

## getdate\_err

The variable is set to the following value when an error occurs in the `getdate()` function.

**Value**   **Description**

- |   |  |
|---|--|
| 1 | The DATEMSK environment variable is NULL or undefined.   |
| 2 | The template file cannot be opened for reading.  |
| 3 | Failed to get file status information.   |
| 4 | The template file is not a regular file.   |
| 5 | An error was encountered while reading the template file.  |
| 6 | Memory allocation failed (not enough memory available).  |
| 7 | No line in the template file matches the input specification.  |
| 8 | Non-valid input specification. For example, February 31 or a time that can not be represented in a <code>time_t</code> (representing the time in seconds since Epoch - midnight, January 1, 1970 (UTC)). |
| 9 | Unable to determine current time.  |

**Note:** This value is unique for z/OS UNIX.

Any changes to `errno` are unspecified. Use the `__gderr()` function to access the thread-specific value of `getdate_err`. The `getdate64()` function affects the same pointer to the thread-specific value of `getdate_err` as `__gderr()` does. The `getdate64()` function also uses the same `getdate_err` values as `getdate()` does. See also `time.h`.

---

## h\_errno

An integer that holds the specific error code when the network nameserver encounters an error. The network nameserver is used by the `gethostbyname()` and `gethostbyaddr()` functions. Use the `__h_errno()` function to access the thread-specific value of `h_errno`. See also `netdb.h`.

---

## \_\_loc1

A global character pointer that is set by the `regex()` function to point to the first matched character in the input string. Use the `___loc1()` function to access the thread-specific value of `__loc1`. `__loc1` is not supported in AMODE 64 applications. See also `libgen.h`.

---

## loc1

A pointer to characters matched by regular expressions used by `step()`. The value is not propagated across a call to a fetched module. `loc1` is not supported in AMODE 64 applications. See also `regex.h`.

---

## loc2

A pointer to characters matched by regular expressions used by `step()`. The value is not propagated across a call to a fetched module. `loc2` is not supported in AMODE 64 applications. See also `regexp.h`.

---

## locs

Used by `advance()` to stop regular expression matching in a string. The value is not propagated across a call to a fetched module. `locs` is not supported in AMODE 64 applications. See also `regexp.h`.

---

## optarg

Character pointer used by `getopt()` for options parsing variables. Use the `__optargf()` function to access the thread-specific value of `optarg`. See also `stdio.h` and `unistd.h`.

---

## opterr

Error value used by `getopt()`. Use the `__operrf()` function to access the thread-specific value of `opterr`. See also `stdio.h` and `unistd.h`.

---

## optind

Integer pointer used by `getopt()` for options parsing variables. Use the `__opindf()` function to access the thread-specific value of `optind`. See also `stdio.h` and `unistd.h`.

---

## optopt

Integer pointer used by `getopt()` for options parsing variables. Use the `__opoptf()` function to access the thread-specific value of `optopt`. See also `stdio.h` and `unistd.h`.

---

## signgam

Storage for sign of `lgamma()`. This function defaults to thread specific. See also `math.h`.

---

## stdin

Standard Input stream. The external variable will be initialized to point to the enclave-level stream pointer for the standard input file. There is no multithreaded function. See also `stdio.h`.

---

## stderr

Standard Error stream. The external variable will be initialized to point to the enclave-level stream pointer for the standard error file. There is no multithreaded function. See also `stdio.h`.

---

---

## stdout

Standard Output stream. The external variable will be initialized to point to the enclave-level stream pointer for the standard output file. There is no multithreaded function. See also `stdio.h`.

---

## t\_errno

An integer that holds the specific error code when a failure occurs in one of the X/Open Transport Interface (XTI) functions. Use the `__t_errno()` function to access the thread-specific value of `t_errno`. See also `xti.h`.

---

## timezone

Long integer difference from UTC and standard time as set by `tzset()`. Note that other time zone sensitive functions such as `ctime()`, `localtime()`, `mktime()`, and `strftime()` implicitly call `tzset()`. Use the `__tzone()` function to access the thread-specific value of `timezone`. See also `time.h`.

---

## tzname

Character pointer to unsized array of timezone strings used by `tzset()` and `ctime()`. The `*tzname` variable contains the Standard and Daylight Savings time zone names. If the TZ environment variable is present and correct, `tzname` is set from TZ. Otherwise `tzname` is set from the LC\_TOD locale category. See the `tzset()` function for a description. There is no multithreaded function. See also `time.h`.

---

## Appendix K. Packaging considerations

When you develop a program, library, or application that will be shipped as a product, you should use SMP/E to manage the installation. This information provides hints and tips for packaging a C or C++ application. It assumes that you are familiar with SMP/E concepts and terminology. For more information about SMP/E and packaging rules, refer to the following manuals:

- *SMP/E for z/OS Reference*
- *SMP/E for z/OS User's Guide*
- *Standard packaging rules for MVS-based products*

The way you package your product may have a significant impact on its relationship with other products, its dependency on libraries, and the way it is eventually serviced. For this reason, you should make a packaging plan as part of the design process for your product.

For more information about these compiler options, see *z/OS XL C/C++ User's Guide*.

---

### Compiler options

The following options are useful when you compile a program that will be packaged as a product:

#### TARGET

If your product will run on multiple releases of z/OS, use the TARGET compiler option to specify the lowest level of the z/OS Language Environment that you will support. The compiler will notify you if your application uses any features that are not supported at this level.

The target must be the same release as the compiler or a previous release. If the target is a previous release, you must link with the system library of the target system. You cannot link with libraries from the current release and run the resulting executable with a previous release of z/OS Language Environment.

#### CSECT

Use the CSECT compiler option or `#pragma csect` to assign names to CSECTs. This provides you with more control and flexibility when you service the product.

For more information about these compiler options, see *z/OS XL C/C++ User's Guide*.

---

### Libraries

Your product can use various type of libraries:

#### z/OS Language Environment libraries

Because z/OS Language Environment is upward-compatible, a program that runs on a lower level of z/OS Language Environment can also run on higher levels without being relinked or recompiled. You can optionally recompile your programs, if you want to take advantage of new features that are introduced to z/OS Language Environment.

### Your own libraries

If your program uses your own libraries, you can statically bind the libraries with the program and consider them an integral part of the product.

### Third-party libraries

If your application uses third-part vendor libraries, you should consider whether the linking is static or dynamic (if it is a DLL), and whether the libraries are upward-compatible. If you statically link a library with your application, you can use either the ++MOD method or the ++PROGRAM method, as described in "Linking."

---

## Prelinking

You must use the z/OS Language Environment prelinker before linking your application if the resultant load module will reside in a PDS *and* any of the following are true:

- Your application contains C++ code.
- Your application contains C code that is compiled with the RENT, LONGNAME, DLL, or IPA compiler option.
- Your application is compiled to run under z/OS UNIX System Services.

SMP/E will not invoke the prelinker. If your product needs to be prelinked, you should usually prelink as part of your product build and ship the prelinker output on the SMP/E tape.

---

## Linking

There are two ways to ship an application that is statically linked to a library:

- You can use the ++MOD command to build the application, and not perform the final link to the library until the product is installed. If the customer later installs a PTF for this library, your application will automatically be relinked.
- You can build the application and link it to the library, and then install it using the ++PROGRAM command. If a PTF is issued for the library, this will have no effect until you include the updated library in a PTF for your product.

### ++MOD method

If you want to do the final link-edit step during installation, use the ++MOD command statement in the MCS. You must compile and then partially link your program with any libraries that will not exist on the customer's system, and then produce output in link-edited format. Any references to libraries that will exist on the customer's system, such as z/OS Language Environment libraries, are unresolved. Ship this link-edited module on the SMP/E tape.

At installation time, the application is linked to the libraries on the customer's system. For example, on z/OS V1R4, the application is linked to z/OS Language Environment V1R4 libraries.

SMP/E supports the automatic library call facility through the use of SYSLIB DD statements. This allows you to implicitly include modules without explicitly specifying them in the JCLIN. This can provide flexibility if the link-edit structure of the application must change during servicing, for example because new functions are used.

When you service a ++MOD, you must ship your fixes using a ++PTF command statement. The SMP/E tape must contain the text deck (object files) in fixed-block 80 format. SMP/E invokes the link-editor to rebind the new text deck with the existing load module. You must name all of the CSECTs, using the CSECT compiler option or #pragma csect. (If you do not name the CSECTs, CSECT replacement would not happen. Old text records would accumulate in the load module as you ship out subsequent fixes for your product.)

To allow rebind, you must also use the EDIT=YES option in the bind step. This is the default.

## **++PROGRAM method**

You can choose to do the final link step as part of your product build, and ship the output load module to your customer. The advantage is that the whole build process is under your control, and you can perform the final testing of the load module in your own controlled environment.

If your customers have different levels of z/OS Language Environment, you must target your build to the lowest level and link with system libraries at this level. Your product will have a prerequisite that the customer must have z/OS Language Environment at this level or a higher level.

If service is applied to any linked library, this will have no effect on your product until you include the service in a PTF.

The ++PTF command, which is used for shipping and applying fixes, expects input in fixed-block 80 format. The output of the link step is not in this format. You can convert it as follows:

1. UNLOAD - use IEBCOPY to copy the module and its alias (if any) to a sequential file.
2. Run the SMP/E utility GIMDTS to convert the sequential file to a fixed-block 80 file.

Conceptually, the ++PROGRAM copies the whole load module to your customer's target dataset with no additional processing. Your customer receives the module exactly as you ship it.



---

## Appendix L. Accessibility

Accessible publications for this product are offered through IBM Knowledge Center ([www.ibm.com/support/knowledgecenter/SSLTBW/welcome](http://www.ibm.com/support/knowledgecenter/SSLTBW/welcome)).

If you experience difficulty with the accessibility of any z/OS information, send a detailed message to the Contact z/OS web page ([www.ibm.com/systems/z/os/zos/webqs.html](http://www.ibm.com/systems/z/os/zos/webqs.html)) or use the following mailing address.

IBM Corporation  
Attention: MHVRCFS Reader Comments  
Department H6MA, Building 707  
2455 South Road  
Poughkeepsie, NY 12601-5400  
United States

---

### Accessibility features

Accessibility features help users who have physical disabilities such as restricted mobility or limited vision use software products successfully. The accessibility features in z/OS can help users do the following tasks:

- Run assistive technology such as screen readers and screen magnifier software.
- Operate specific or equivalent features by using the keyboard.
- Customize display attributes such as color, contrast, and font size.

---

### Consult assistive technologies

Assistive technology products such as screen readers function with the user interfaces found in z/OS. Consult the product information for the specific assistive technology product that is used to access z/OS interfaces.

---

### Keyboard navigation of the user interface

You can access z/OS user interfaces with TSO/E or ISPF. The following information describes how to use TSO/E and ISPF, including the use of keyboard shortcuts and function keys (PF keys). Each guide includes the default settings for the PF keys.

- *z/OS TSO/E Primer*
- *z/OS TSO/E User's Guide*
- *z/OS V2R2 ISPF User's Guide Vol I*

---

### Dotted decimal syntax diagrams

Syntax diagrams are provided in dotted decimal format for users who access IBM Knowledge Center with a screen reader. In dotted decimal format, each syntax element is written on a separate line. If two or more syntax elements are always present together (or always absent together), they can appear on the same line because they are considered a single compound syntax element.

Each line starts with a dotted decimal number; for example, 3 or 3.1 or 3.1.1. To hear these numbers correctly, make sure that the screen reader is set to read out



punctuation. All the syntax elements that have the same dotted decimal number (for example, all the syntax elements that have the number 3.1) are mutually exclusive alternatives. If you hear the lines 3.1 USERID and 3.1 SYSTEMID, your syntax can include either USERID or SYSTEMID, but not both.

The dotted decimal numbering level denotes the level of nesting. For example, if a syntax element with dotted decimal number 3 is followed by a series of syntax elements with dotted decimal number 3.1, all the syntax elements numbered 3.1 are subordinate to the syntax element numbered 3.

Certain words and symbols are used next to the dotted decimal numbers to add information about the syntax elements. Occasionally, these words and symbols might occur at the beginning of the element itself. For ease of identification, if the word or symbol is a part of the syntax element, it is preceded by the backslash (\) character. The \* symbol is placed next to a dotted decimal number to indicate that the syntax element repeats. For example, syntax element \*FILE with dotted decimal number 3 is given the format 3 \\* FILE. Format 3\* FILE indicates that syntax element FILE repeats. Format 3\* \\* FILE indicates that syntax element \* FILE repeats.

Characters such as commas, which are used to separate a string of syntax elements, are shown in the syntax just before the items they separate. These characters can appear on the same line as each item, or on a separate line with the same dotted decimal number as the relevant items. The line can also show another symbol to provide information about the syntax elements. For example, the lines 5.1\*, 5.1 LASTRUN, and 5.1 DELETE mean that if you use more than one of the LASTRUN and DELETE syntax elements, the elements must be separated by a comma. If no separator is given, assume that you use a blank to separate each syntax element.

If a syntax element is preceded by the % symbol, it indicates a reference that is defined elsewhere. The string that follows the % symbol is the name of a syntax fragment rather than a literal. For example, the line 2.1 %OP1 means that you must refer to separate syntax fragment OP1.

The following symbols are used next to the dotted decimal numbers.

**? indicates an optional syntax element**

The question mark (?) symbol indicates an optional syntax element. A dotted decimal number followed by the question mark symbol (?) indicates that all the syntax elements with a corresponding dotted decimal number, and any subordinate syntax elements, are optional. If there is only one syntax element with a dotted decimal number, the ? symbol is displayed on the same line as the syntax element, (for example 5? NOTIFY). If there is more than one syntax element with a dotted decimal number, the ? symbol is displayed on a line by itself, followed by the syntax elements that are optional. For example, if you hear the lines 5 ?, 5 NOTIFY, and 5 UPDATE, you know that the syntax elements NOTIFY and UPDATE are optional. That is, you can choose one or none of them. The ? symbol is equivalent to a bypass line in a railroad diagram.

**! indicates a default syntax element**

The exclamation mark (!) symbol indicates a default syntax element. A dotted decimal number followed by the ! symbol and a syntax element indicate that the syntax element is the default option for all syntax elements that share the same dotted decimal number. Only one of the syntax elements that share the dotted decimal number can specify the ! symbol. For example, if you hear the lines 2? FILE, 2.1! (KEEP), and 2.1 (DELETE), you know that (KEEP) is the

default option for the FILE keyword. In the example, if you include the FILE keyword, but do not specify an option, the default option KEEP is applied. A default option also applies to the next higher dotted decimal number. In this example, if the FILE keyword is omitted, the default FILE(KEEP) is used. However, if you hear the lines 2? FILE, 2.1, 2.1.1! (KEEP), and 2.1.1 (DELETE), the default option KEEP applies only to the next higher dotted decimal number, 2.1 (which does not have an associated keyword), and does not apply to 2? FILE. Nothing is used if the keyword FILE is omitted.

**\* indicates an optional syntax element that is repeatable**

The asterisk or glyph (\*) symbol indicates a syntax element that can be repeated zero or more times. A dotted decimal number followed by the \* symbol indicates that this syntax element can be used zero or more times; that is, it is optional and can be repeated. For example, if you hear the line 5.1\* data area, you know that you can include one data area, more than one data area, or no data area. If you hear the lines 3\* , 3 HOST, 3 STATE, you know that you can include HOST, STATE, both together, or nothing.

**Notes:**

1. If a dotted decimal number has an asterisk (\*) next to it and there is only one item with that dotted decimal number, you can repeat that same item more than once.
2. If a dotted decimal number has an asterisk next to it and several items have that dotted decimal number, you can use more than one item from the list, but you cannot use the items more than once each. In the previous example, you can write HOST STATE, but you cannot write HOST HOST.
3. The \* symbol is equivalent to a loopback line in a railroad syntax diagram.

**+ indicates a syntax element that must be included**

The plus (+) symbol indicates a syntax element that must be included at least once. A dotted decimal number followed by the + symbol indicates that the syntax element must be included one or more times. That is, it must be included at least once and can be repeated. For example, if you hear the line 6.1+ data area, you must include at least one data area. If you hear the lines 2+, 2 HOST, and 2 STATE, you know that you must include HOST, STATE, or both. Similar to the \* symbol, the + symbol can repeat a particular item if it is the only item with that dotted decimal number. The + symbol, like the \* symbol, is equivalent to a loopback line in a railroad syntax diagram.



---

## Notices

This information was developed for products and services offered in the U.S.A. or elsewhere.

IBM may not offer the products, services, or features discussed in this document in other countries. Consult your local IBM representative for information on the products and services currently available in your area. Any reference to an IBM product, program, or service is not intended to state or imply that only that IBM product, program, or service may be used. Any functionally equivalent product, program, or service that does not infringe any IBM intellectual property right may be used instead. However, it is the user's responsibility to evaluate and verify the operation of any non-IBM product, program, or service.

IBM may have patents or pending patent applications covering subject matter described in this document. The furnishing of this document does not give you any license to these patents. You can send license inquiries, in writing, to:

IBM Director of Licensing  
IBM Corporation  
North Castle Drive  
Armonk, NY 10504-1785  
U.S.A

For license inquiries regarding double-byte character set (DBCS) information, contact the IBM Intellectual Property Department in your country or send inquiries, in writing, to:

Intellectual Property Licensing  
Legal and Intellectual Property Law  
IBM Japan, Ltd.  
19-21, Nihonbashi-Hakozakicho, Chuo-ku  
Tokyo 103-8510, Japan

The following paragraph does not apply to the United Kingdom or any other country where such provisions are inconsistent with local law: INTERNATIONAL BUSINESS MACHINES CORPORATION PROVIDES THIS PUBLICATION "AS IS" WITHOUT WARRANTY OF ANY KIND, EITHER EXPRESS OR IMPLIED, INCLUDING, BUT NOT LIMITED TO, THE IMPLIED WARRANTIES OF NON-INFRINGEMENT, MERCHANTABILITY OR FITNESS FOR A PARTICULAR PURPOSE. Some states do not allow disclaimer of express or implied warranties in certain transactions, therefore, this statement may not apply to you.

This information could include technical inaccuracies or typographical errors. Changes are periodically made to the information herein; these changes will be incorporated in new editions of the publication. IBM may make improvements and/or changes in the product(s) and/or the program(s) described in this publication at any time without notice.

Any references in this information to non-IBM Web sites are provided for convenience only and do not in any manner serve as an endorsement of those Web sites. The materials at those Web sites are not part of the materials for this IBM product and use of those Web sites is at your own risk.

IBM may use or distribute any of the information you supply in any way it believes appropriate without incurring any obligation to you.

Licensees of this program who wish to have information about it for the purpose of enabling: (i) the exchange of information between independently created programs and other programs (including this one) and (ii) the mutual use of the information which has been exchanged, should contact:

Site Counsel  
IBM Corporation  
2455 South Road  
Poughkeepsie, NY 12601-5400  
USA

Such information may be available, subject to appropriate terms and conditions, including in some cases, payment of a fee.

The licensed program described in this information and all licensed material available for it are provided by IBM under terms of the IBM Customer Agreement, IBM International Program License Agreement, or any equivalent agreement between us.

Information concerning non-IBM products was obtained from the suppliers of those products, their published announcements or other publicly available sources. IBM has not tested those products and cannot confirm the accuracy of performance, compatibility or any other claims related to non-IBM products. Questions on the capabilities of non-IBM products should be addressed to the suppliers of those products.

All statements regarding IBM's future direction or intent are subject to change or withdrawal without notice, and represent goals and objectives only.

If you are viewing this information softcopy, the photographs and color illustrations may not appear.

#### COPYRIGHT LICENSE:

This information might contain sample application programs in source language, which illustrate programming techniques on various operating platforms. You may copy, modify, and distribute these sample programs in any form without payment to IBM, for the purposes of developing, using, marketing or distributing application programs conforming to the application programming interface for the operating platform for which the sample programs are written. These examples have not been thoroughly tested under all conditions. IBM, therefore, cannot guarantee or imply reliability, serviceability, or function of these programs. The sample programs are provided "AS IS", without warranty of any kind. IBM shall not be liable for any damages arising out of your use of the sample programs.

---

## Policy for unsupported hardware

Various z/OS elements, such as DFSMS, HCD, JES2, JES3, and MVS, contain code that supports specific hardware servers or devices. In some cases, this device-related element support remains in the product even after the hardware devices pass their announced End of Service date. z/OS may continue to service element code; however, it will not provide service related to unsupported hardware devices. Software problems related to these devices will not be accepted

for service, and current service activity will cease if a problem is determined to be associated with out-of-support devices. In such cases, fixes will not be issued.

---

## Minimum supported hardware

The minimum supported hardware for z/OS releases identified in z/OS announcements can subsequently change when service for particular servers or devices is withdrawn. Likewise, the levels of other software products supported on a particular release of z/OS are subject to the service support lifecycle of those products. Therefore, z/OS and its product publications (for example, panels, samples, messages, and product documentation) can include references to hardware and software that is no longer supported.

- For information about software support lifecycle, see: IBM Lifecycle Support for z/OS ([www.ibm.com/software/support/systemsz/lifecycle](http://www.ibm.com/software/support/systemsz/lifecycle))
- For information about currently-supported IBM hardware, contact your IBM representative.

---

## Permission Notice

This book includes information about certain callable service stub and linkage-assist (stub) routines contained in specific data sets that are intended to be bound or link-edited with code and run on z/OS systems. In connection with your authorized use of z/OS, you may bind or link-edit these stubs into your modules and distribute your modules with the included stubs for the purposes of developing, using, marketing and distributing programs conforming to the documented programming interfaces for z/OS, provided that each stub is included in its entirety, including any IBM copyright statements. These stubs have not been thoroughly tested under all conditions. IBM, therefore, cannot guarantee or imply the reliability, serviceability, or function of these stub programs. The stubs referred to in this book are contained in one or more of the following data sets:

- CEE.SAFHFORT
- CEE.SCEEBIND
- CEE.SCEEEND2
- CEE.SCEECP
- CEE.SCEELKED
- CEE.SCEELKEX
- CEE.SCEEOBJ
- CEE.SCEESPC
- CEE.SIBMAM24
- CEE.SIBMCALL
- CEE.SIBMCAL2
- CEE.SIBMMATH
- CEE.SIBMTASK

---

## Programming interface information

This publication documents *intended* Programming Interfaces that allow the customer to write z/OS XL C/C++ programs.

---

## Trademarks

IBM, the IBM logo, and `ibm.com` are trademarks or registered trademarks of International Business Machines Corp., registered in many jurisdictions worldwide. Other product and service names might be trademarks of IBM or other companies. A current list of IBM trademarks is available on the Web at “Copyright and trademark information” at [www.ibm.com/legal/copytrade.shtml](http://www.ibm.com/legal/copytrade.shtml).

Adobe, Acrobat, PostScript and all Adobe-based trademarks are either registered trademarks or trademarks of Adobe Systems Incorporated in the United States, other countries, or both.

Microsoft, Windows, Windows NT, and the Windows logo are trademarks of Microsoft Corporation in the United States, other countries, or both.

UNIX is a registered trademark of The Open Group in the United States and other countries.

Java and all Java-based trademarks and logos are trademarks or registered trademarks of Oracle and/or its affiliates.

Linux is a trademark of Linus Torvalds in the United States, other countries, or both.

Other company, product, or service names may be trademarks or service marks of others.

---

## Standards

The following standards are supported in combination with the Language Environment element:

- The C language is consistent with *Programming languages - C (ISO/IEC 9899:1999)* and a subset of *Programming languages - C (ISO/IEC 9899:2011)*. For more information on ISO, visit their website at <http://www.iso.org>.
- The C++ language is consistent with *Programming languages - C++ (ISO/IEC 14882:1998)*, *Programming languages - C++ (ISO/IEC 14882:2003(E))*, and a subset of *Programming languages - C++ (ISO/IEC 14882:2011)*.

The following standards are supported in combination with the Language Environment and z/OS UNIX System Services elements:

- A subset of *IEEE Std. 1003.1-2001 (Single UNIX Specification, Version 3)*. For more information on IEEE, visit their website at <http://www.iso.org>.
- *IEEE Std 1003.1—1990, IEEE Standard Information Technology—Portable Operating System Interface (POSIX)—Part 1: System Application Program Interface (API) [C language]*, copyright 1990 by the Institute of Electrical and Electronic Engineers, Inc.
- The core features of *IEEE P1003.1a Draft 6 July 1991, Draft Revision to Information Technology—Portable Operating System Interface (POSIX), Part 1: System Application Program Interface (API) [C Language]*, copyright 1992 by the Institute of Electrical and Electronic Engineers, Inc.
- *IEEE Std 1003.2—1992, IEEE Standard Information Technology—Portable Operating System Interface (POSIX)—Part 2: Shells and Utilities*, copyright 1990 by the Institute of Electrical and Electronic Engineers, Inc.

- The core features of *IEEE Std P1003.4a/D6—1992, IEEE Draft Standard Information Technology—Portable Operating System Interface (POSIX)—Part 1: System Application Program Interface (API)—Amendment 2: Threads Extension [C language]*, copyright 1990 by the Institute of Electrical and Electronic Engineers, Inc.
- The core features of *IEEE 754-1985 (R1990) IEEE Standard for Binary Floating-Point Arithmetic (ANSI)*, copyright 1985 by the Institute of Electrical and Electronic Engineers, Inc.
- *X/Open CAE Specification, System Interfaces and Headers, Issue 4 Version 2*, copyright 1994 by The Open Group
- *X/Open CAE Specification, Networking Services, Issue 4*, copyright 1994 by The Open Group
- *X/Open Specification Programming Languages, Issue 3, Common Usage C*, copyright 1988, 1989, and 1992 by The Open Group
- United States Government's *Federal Information Processing Standard (FIPS) publication for the programming language C, FIPS-160*, issued by National Institute of Standards and Technology, 1991





---

## Bibliography

This bibliography lists the publications for IBM products that are related to z/OS XL C/C++. It includes publications covering the application programming task. The bibliography is not a comprehensive list of the publications for these products, however, it should be adequate for most z/OS XL C/C++ users. Refer to *z/OS V2R2 Information Roadmap, SA23-2299*, for a complete list of publications belonging to the z/OS product.

### **z/OS**

- *z/OS Introduction and Release Guide, GA32-0887*
- *z/OS Planning for Installation, GA32-0890*
- *z/OS Summary of Message and Interface Changes, SA23-2300*
- *z/OS V2R2 Information Roadmap, SA23-2299*
- *z/OS Licensed Program Specifications, GA32-0888*
- *z/OS Migration, GA32-0889*
- *z/OS Program Directory, GI11-9848*

### **z/OS XL C/C++**

- *z/OS XL C/C++ Programming Guide, SC14-7315*
- *z/OS XL C/C++ User's Guide, SC14-7307*
- *z/OS XL C/C++ Language Reference, SC14-7308*
- *z/OS XL C/C++ Messages, GC14-7305*
- *z/OS XL C/C++ Runtime Library Reference, SC14-7314*
- *z/OS C Curses, SA38-0690*
- *z/OS XL C/C++ Compiler and Runtime Migration Guide for the Application Programmer, GC14-7306*
- *Standard C++ Library Reference, SC14-7309*

### **z/OS Metal C Runtime Library**

- *z/OS Metal C Programming Guide and Reference, SC14-7313*

### **z/OS Runtime Library Extensions**

- *z/OS Common Debug Architecture User's Guide, SC14-7310*
- *z/OS Common Debug Architecture Library Reference, SC14-7311*
- *DWARF/ELF Extensions Library Reference, SC14-7312*

### **Debug Tool**

- Debug Tool documentation, which is available at <http://www.ibm.com/software/awdtools/debugtool/library/>.

### **z/OS Language Environment**

- *z/OS V2R1.0 Language Environment Concepts Guide, SA38-0687*
- *z/OS Language Environment Customization, SA38-0685*
- *z/OS Language Environment Debugging Guide, GA32-0908*
- *z/OS Language Environment Programming Guide, SA38-0682*
- *z/OS Language Environment Programming Reference, SA38-0683*

- *z/OS V2R1.0 Language Environment Runtime Application Migration Guide, GA32-0912*
- *z/OS V2R1.0 Language Environment Writing Interlanguage Communication Applications, SA38-0684*
- *z/OS Language Environment Runtime Messages, SA38-0686*

## **Assembler**

- *HLASM Language Reference, SC26-4940*
- *HLASM Programmer's Guide, SC26-4941*

## **COBOL**

- COBOL documentation, which is available at <http://www.ibm.com/software/awdtools/cobol/zos/library/>.

## **PL/I**

- PL/I documentation, which is available at <http://www.ibm.com/software/awdtools/pli/plizos/library/>.

## **VS FORTRAN**

- VS FORTRAN documentation, which is available at <http://www.ibm.com/software/awdtools/fortran/vsfortran/library.html>.

## **CICS Transaction Server for z/OS**

- CICS Transaction Server for z/OS documentation, which is available at <http://www.ibm.com/software/htp/cics/>

## **DB2**

- DB2 for z/OS documentation, which is available at <http://www.ibm.com/software/data/db2/zos/library.html>.

## **IMS/ESA®**

- IMS documentation, which is available at <http://www.ibm.com/software/data/ims/library.html>.

## **MVS**

- *z/OS MVS Program Management: User's Guide and Reference, SA23-1393*
- *z/OS MVS Program Management: Advanced Facilities, SA23-1392*

## **QMF**

- QMF documentation, which is available at <http://www.ibm.com/software/data/qmf/library.html>.

## **DFSMS**

- *z/OS DFSMS Introduction, SC23-6851*
- *z/OS DFSMS Managing Catalogs, SC23-6853*
- *z/OS DFSMS Using Data Sets, SC23-6855*
- *z/OS DFSMS Macro Instructions for Data Sets, SC23-6852*
- *z/OS DFSMS Access Method Services Commands, SC23-6846*

# Index

## Special characters

\_\_abendcode macro, using for debugging 225  
\_\_amrc structure  
  debugging I/O programs 223  
  example 226  
  using with VSAM 154, 177  
\_\_amrc2 structure  
  usage 227  
\_\_csplist() library function 905  
\_\_last\_op codes for \_\_amrc 227  
\_\_rsncode macro 225, 418  
\_\_STDC\_CONSTANT\_MACROS feature test macro 678  
\_\_STDC\_FORMAT\_MACROS feature test macro 678  
\_\_STDC\_LIMIT\_MACROS feature test macro 678  
\_24malc() library function 835  
\_4kmalc() library function 836  
\_EDC\_ERRNO\_DIAG environment variable 491  
\_EDC\_GLOBAL\_STREAMS environment variable 493  
\_EDC\_IEEEV1\_COMPATIBILITY\_ENV environment variable 493  
\_EDC\_IO\_ABEND environment variable 494  
\_EDC\_IO\_TRACE environment variable 495  
\_EDC\_OPEN\_CONCAT environment variable 497  
\_EDC\_POPEM environment variable 497  
\_EDC\_PTHREAD\_YIELD environment variable 497  
\_EDC\_PTHREAD\_YIELD\_MAX environment variable 498  
\_EDC\_PUTENV\_COPY environment variable 498  
\_EDC\_RRDS\_HIDE\_KEY environment variable 163  
\_ICONV\_UCS2 environment variable 1042  
\_ICONV\_UCS2\_PREFIX environment variable 1036  
\_ISOC99\_SOURCE feature test macro 678  
\_LP64 macro  
  64-bit 351  
  TR1\_C99 feature test macro 678  
  TZ environment variable 1013  
\_xhotc() library function 831  
\_xhotl() library function 832  
\_xhott() library function 832  
\_xhotu() library function 833  
\_xregs() library function 833  
\_xsacc() library function 834  
\_xsrvc() library function 835  
\_xusr() library function 835  
\_xusr2() library function 835  
! (exclamation mark) 1083

// (double slash), part of MVS data set name 84, 157  
/\* (EOF sequence for text terminal) 193  
\a (alarm) 109  
\b (backspace) 109  
\f (form feed) 109  
\n (newline) 109  
\r (carriage return) 109  
\t (horizontal tab) 109  
\v (vertical tab) 109  
\x0E (DBCS shift out) 109  
\x0F (DBCS shift in) 109  
] (right square bracket) and [ (left square bracket) 1083  
| (vertical bar) 1083  
& (ampersand)  
  using to specify temporary data set names 84  
# (number sign) 1083  
#pragma csect  
  packaging products 1162  
  shipping fixes 1162  
{ (left brace) 1083  
} (right brace) 1083  
^ (caret) 1083  
~ (tilde) 1083

## Numerics

24malc() library function 835  
32-bit application  
  recompiling as 64-bit 327  
4kmalc() library function 836  
64 bit offsets 144  
64-bit  
  \_LP64 macro 351  
  environment 325  
  migrating from 32-bit 331  
  pointers 341  
  printf 347  
  structure alignment 332  
64-bit virtual memory  
  IPA(LINK) 332

## A

abend  
  CICS and assembler user exit 845  
  codes  
    CEEEXITA, CEEAUE\_RET  
    field 843  
    specifying those to be percolated 846  
  dumps, CEEAUE\_DUMP 845  
  generating 823  
  percolating 841, 846  
  requesting dump 845  
  system 841, 846  
  TRAP runtime option 842  
  user 841, 846

ABEND, compiler  
  insufficient storage 332  
  MEMLIMIT system parameter and IMEMLIM variable 332  
absolute value, decimal type 391  
acc parameter for fopen()  
  memory file I/O 204  
  terminal I/O 193  
  VSAM data sets 159  
  z/OS OS I/O 100  
accept(), network example 434  
access control list (ACL) 149  
access method selection 97  
accessibility 1165  
  contact IBM 1165  
  features 1165  
accessing UNIX file system files  
  optimizing 721  
ACL (access control list) 149  
additive operators, decimal 381  
addressing  
  within AF\_INET domain 431  
  within AF\_INET6 domain 431  
  within AF\_UNIX domain 432  
  within sockets 429  
addressing capabilities  
  ILP32 and LP64 325  
AF\_INET domain  
  addressing 431  
  defined 431  
AF\_INET6 domain  
  addressing 431  
AF\_UNIX domain  
  addressing 432  
  defined 432  
alarm escape sequence \a 109  
alignment  
  z/OS basic rule 333  
alloca() library function 717  
alternate code point support 1049  
AMODE processing option  
  for CEEEXITA user exit 842  
AMODE/RMODE under CICS 880, 901  
ANSI C++ 98 applications  
  C99 behavior 677  
ANSIALIAS compiler option 725  
APL coded character set 293  
  code point mappings for hexadecimal values 1089  
application service routines 807  
application, network 437  
ARCHITECTURE compiler option 725  
argc under CICS 886  
ARGPARSE runtime option 262  
argv under CICS 886  
arithmetic  
  constructions 704  
  operators, decimal data type  
    additive 381  
    conditional 382  
    equality 382

- arithmetic (*continued*)
  - operators, decimal data type (*continued*)
    - multiplicative 381
    - relational 381
- ASA (American Standards Association)
  - control characters 47
  - example 47
  - overview 47
- ASCII limitations 955
- asis parameter, fopen()
  - memory file I/O 204
  - terminal I/O 193
  - VSAM data sets 160
  - z/OS OS I/O 100
- assembler
  - assembler user exit for termination
    - of 843
  - epilog 250
  - example 257, 263
  - interlanguage calls 245
  - level 249
  - macros 245
  - multiple invocations 258
  - prolog 249, 250, 254
  - system programming alternative 789
- ASSERT(RESTRICT) compiler
  - option 726
- assignment
  - operators, decimal 383
  - standard stream 70
- assistive technologies 1165
- asynchronous I/O (z/OS) 102
- atoi() library function 718

## B

- backspace escape sequence \b 109
- BDAM data sets, restriction 83
- BDW (block descriptor word) 98
- bibliography 1175
- bidirectional languages 1065
- binary files
  - byte stream behavior 21
  - fixed behavior 13
  - undefined format behavior 19
  - using fseek() and ftell(), OS I/O 117
  - variable behavior 18
- binary floating-point support
  - built-in instructions, hardware 545
- binary I/O, description 8
- bind(), network example 433
- bit fields
  - referencing
    - and optimization 705
- blksize parameter
  - defaults 35
  - memory file I/O 204
  - specifying 34
  - terminal I/O 192
  - VSAM data sets 159
  - z/OS OS I/O 99
- blocked
  - files, using fseek() and ftell() 119
- blocked I/O, description 8
- blocked records 12
- BookManager documents xxxii

- buffers
  - full buffering 45
  - line buffering 45
  - multiple 102
  - no buffering
    - memory files 45
    - UNIX file system files 45
  - OS I/O 101
  - terminal I/O 193
  - terminology
    - buffering 45
    - using 45
- BUFNO subparameter, multiple buffering 102
- built-in functions
  - \_\_builtin\_expect 716
  - decabs() 391
  - decchk() 390, 395
  - decfix() 391
  - hardware 505
- built-in instructions, hardware
  - binary floating-point instructions 545
  - decimal floating-point 534
  - decimal instructions 528
  - floating-point instructions 533
  - general instructions 505
  - hexadecimal floating-point instructions 544
  - Store Clock Fast 505
  - transaction execution 547
- byte order, network 430
- byteseek parameter in fopen()
  - effects on OS files 117
  - memory file I/O 204
  - terminal I/O 193
  - VSAM data sets 160
  - z/OS OS I/O 100

## C

- C locale
  - comparing with POSIX and SAA locales 1022
  - defined 1015
- C or C++ interlanguage calls
  - with assembler 245
  - with C++ 239
  - with COBOL 239
  - with FORTRAN 239
  - with PL/I 239
- C++
  - optimizing 695
- c99 interfaces
  - exposure to XL C++ applications 677
- C99 support
  - ANSI C and C++ 98 applications 677
- CALL
  - command 905
  - token for preinitialization 260
- calling
  - assembler from C or C++ 245
  - C from C++ 239
  - C or C++ from assembler 245
  - C++ from C 239
  - COBOL from C or C++ 239
  - FORTRAN from C or C++ 239
  - functions repeatedly 258
- calling (*continued*)
  - PL/I from C or C++ 239
- card
  - punch output 96
  - reader input 96
- carriage return escape sequence \r 109
- case sensitivity
  - linkage specification 242
- cast operator, decimal 385
- catalogued procedure 449
  - changes for sockets 448, 449
  - EDCC sample 449
  - EDCCB sample 448
  - link edit 448
- catalogued procedures
  - IPA Link 332
  - with IMEMLIM variable 332
- catch 403
- CCNGDB4
  - using DB2 with C 924
- CCSID (coded character set id) 149
- cds() library function 717
- cdump() library function 887
- CEE.SCEEMAC 249
- CEEAUE\_ parameters 841
- CEEBINT HLL user exit
  - customizing 839
  - invoking 838
  - using default version 839
- CEEBXITA assembler user exit
  - abends 841
  - customizing for your installation 839
  - during enclave termination 841
  - during process termination 841
  - effects of runtime options 841
  - error handling 842
  - invoking 838, 840
  - using default version 839
- CEESTART
  - creating modules without 793
  - using with MTF 873
- cerr
  - C++ standard error stream 63
  - predefined stream, usage 23
- CESE, CICS data queue 215
- CESO, CICS data queue 215
- Character Set
  - hexadecimal values 1089
  - POSIX 1079
- character sets
  - 293 1089
  - conversion from IBM-1047 1133
  - for APL 1089
  - for Latin 1/Open systems 1089
  - IBM-1047 1089
- character shaping 1066
- character special files (z/OS UNIX file system)
  - creating 128
  - I/O rules 140
  - using 127
- charmap file
  - example 1121
  - input 1079
  - restriction, Japanese Katakana 1081
- charmap section 961
- CHARSETID section 963

- CICS (Customer Information Control System)
  - AMODE/RMODE
    - considerations 880, 901
  - arguments to C or C++ main() 886
  - C program reentrancy 899
  - cdump() library function 887
  - CESE data queue 215
  - CESO data queue 215
  - clock() library function 887
  - compile 894
  - compiling XL C/C++ programs after preprocessing 899
  - Cross System Product (CSP) 905
  - CSD considerations 902
  - csnap() library function 887
  - ctdli() library function 887
  - ctrace() library function 887
  - define and run the program 902
  - designing and coding a program 880
  - developing and XL C/C++ program 879
  - DLL 887
  - dump functions 887
  - dynamic allocation 887
  - EXEC CICS LINK 887
  - EXEC CICS statements
    - example 895
  - EXEC CICS XCTL 887
  - fetch() library function 887
  - floating point arithmetic 887
  - input and output 32, 215
  - interlanguage support 889
  - iscsic() library function 887
  - JCL to translate and compile 899
  - link considerations 902
  - link load module 901
  - linking for reentrancy 901
  - locale support 886, 1064
  - memory file support 885
  - migrating to a newer translation option 894
  - MTF support 886
  - overview 879
  - packed decimal support 886
  - POSIX support 886
  - prelinking 900
  - preparing for use with z/OS Language Environment 879
  - program processing 902
  - program termination 888
  - redirecting standard streams 75
  - reentrancy 902
  - release() library function 887
  - requirements 879
  - runtime options 886
  - SP C support 886
  - standalone CICS translator 895
  - standard stream support 884
  - storage management 888
  - svc99() library function 887
  - system() library function 887
  - translating example 895
  - translating options 894
  - using with IMS 887
  - z/OS UNIX System Services 1155
- CICS (Customer Information Control System) (*continued*)
  - z/OS XL C/C++ integrated CICS translator 894
  - z/OS XL C/C++ library support 886
- cin
  - C++ standard input stream 63
  - predefined stream, usage 23
- CINET 443
- class libraries
  - optimizing 695
- clearenv() library function 475
- clearing memory 717
- client perspective 435
- client/server
  - allocation with socket() 433
  - conversation 432
  - exchanging data 432
  - server perspective 433
- clock() library function 887
- clog
  - C++ standard error stream 63
  - predefined stream, usage 23
- closing
  - memory files 212
  - OS I/O files 120
  - terminal files 198
  - the CELQPIPI MSGRTN file 220
  - VSAM data sets 176
- clrmemf() library function
  - memory I/O files 212
- COBOL
  - assembler user exit 840
  - using linkage specifications 239
- code
  - code point mappings 1089
  - independence 863
  - motion 724
- code conversions
  - CCNGHC1 1133
  - from IBM-1047 character set 1133
- code point mappings
  - hexadecimal values 1089
- coded character set
  - CICS support 879
  - considerations with locale 1047
  - conversion during compile 1057
  - conversion utilities 1023
  - converters supplied 1026
  - IBM-1047
    - converting code to 1051
    - converting to a specific character set 1133
  - IBM-1047 vs. IBM-293 1049
  - independence 1051
  - related to compile-edit cycle 1051
- coded character set id 149
- command
  - syntax diagrams xxv
- common expression elimination 724
- Common INET 443
- Common Programming Interface (CPI) 943
- communication, network basics 426
- communications, interprocess
  - asynchronous signal delivery 412
  - z/OS TCP/IP considerations 446
- COMPACT compiler option 726
- compile-edit cycle related to coded character set 1051
- compiler diagnostics
  - ensuring code portability 329
- compiler options
  - CSECT 1161
  - DLL 1162
  - for packaging products 1161, 1162
  - IPA 1162
  - LOCALE compiler option 1083
  - LONGNAME 1162
  - RENT 1162
  - TARGET 1161
  - under z/OS UNIX System Services 1162
- compiler options
  - LANGLVL(EXTENDED) 377
- compiling 445
  - for a locale 1057
  - include files 447
  - linking 444
  - procedures 444
  - sockets programs 444
  - under batch
    - for Berkeley Sockets 448
    - for X/Open Sockets 449
    - with X Windows 449
  - using c89
    - for Berkeley Sockets 449
    - with X Windows 449
- COMPRESS compiler option 726
- computational independence 856, 863
- concatenation
  - compatibility rules 91
  - in-stream data sets 93
  - sequential and partitioned 91
- condition variable 355
- conditional operators, decimal 382
- configuration file access, z/OS TCP/IP 447
- constant
  - fixed-point decimal 378
  - propagation 724
- constructed reentrancy and XPLINK 370
- contact
  - z/OS 1165
- control characters
  - ASA text files 47
  - OS I/O text files 109
  - terminal I/O files 197
  - z/OS XL C/C++ recognized by text files 7
- conversation 432
- conversions
  - 32-bit to 64-bit 342
  - code set 1023
  - decimal types
    - decimal to decimal 385
    - decimal to floating-point 388
    - decimal to integer 387
    - floating-point to decimal 389
    - integer to decimal 388
  - hybrid code from IBM-1047 1133
  - hybrid code to IBM-1047 1051
  - integers 342



- conversions (*continued*)
  - pointers 342
- convert pragma 1061
- converters, locale code set 1026
- cout
  - C++ standard output stream 63
  - predefined stream, usage 23
- CPI (Common Programming Interface) 943
- creat() library function 128
- cs() library function 717
- CSECT (control section)
  - CEESTART 793
  - compiler option 1161
- CSECT compiler option
  - packaging products 1162
  - shipping fixes 1162
- csid() library function 952
- csnap() library function 887
- CSP (Cross System Product) 905
- CSP/AD (Cross System Product/Application Development) 905
- CSP/AE (Cross System Product/Application Execution) 905
- csplist library function
  - passing parameters 905
- ctdli() library function 887
- ctrace() library function 887
- Curses library 1155
- cursive languages 1065
- CVFT compiler option 726
- CXIT control block 841

## D

- DASD (Direct-Access Storage Device)
  - input and output 83
  - multivolume data sets, input and output 95
  - sequential and partitioned concatenation 91
  - striped data sets, input and output 95
- data alignment
  - 64-bit 344
- data independence 856, 863
- data models
  - ILP32 and LP64 325
- data sets
  - in-stream 93
  - large format sequential 96
  - multivolume 95
  - name
    - opening a memory file 202
    - opening an MVS data set 157
    - opening z/OS OS files 83
  - sequential vs. partitioned concatenation 91
  - striped 95
  - temporary 84
- data structures
  - rule of alignment 333
- data type sizes
  - ILP32 and LP64 325
- data types
  - conversions
    - explicit 385
  - decimal
    - using in C 377
  - fixed-point
    - using in C 377
  - referencing bit fields and optimization 705
- datagram
  - definition 426
  - sockets 429
- DB2
  - application programming environment, z/OS UNIX System Services 1155
  - codepage 921
  - DB2 C/C++ precompiler 922
  - host variables 921
    - example 925
  - invoking DB2 services with z/OS XL C/C++ 922
  - locale support 1064
  - preprocessor directives 921
  - stored procedures and XPLINK 922
  - variable-length source input 921
  - when NOSQL is the default compiler option 921
  - with z/OS XL C/C++ 921
    - examples 923
    - XL C/C++ DB2 coprocessor 921
- DBCS (Double-Byte Character Support)
  - input and output functions 53
  - reading 54
  - shift in character 109
  - shift out character 109
  - writing 56
- DCB (Data Control Block)
  - OS I/O 103
  - parameter on a DD statement 86
  - parameters, optimizing code 719
- ddname
  - creating
    - description 36
    - in source code 37
    - under MVS batch 36
    - under TSO 37
  - opening a z/OS UNIX System Services file system I/O file under MVS 131
  - opening an OS I/O file under z/OS 85
  - restriction 37
- dead code elimination 724
- dead store elimination 724
- Debug Tool
  - CEEBINT and 852
- debugging I/O programs 223
- DEC\_DIG decimal constant
  - numerical limit 379
  - range of values 377
- DEC\_EPSILON decimal constant 379
- DEC\_MAX decimal constant 379
- DEC\_MIN decimal constant 379
- DEC\_PRECISION decimal constant
  - numerical limit 379
  - range of values 377
- decabs() built-in function 391
- decchk() built-in function 390, 395
- decchk() library function 395
- decfix() built-in function 391
- decimal data type
  - absolute value 391
  - assignments 379
  - constants 378
  - conversions 385
  - declarations 377
  - error messages 395
  - exception handling 394
  - fixing sign of 391
  - operators 380
  - printing with library functions 390
  - SPC restriction 394
  - validating 390
  - variables 378
  - viewing with library functions 390
- decimal data types
  - and variable arguments 390
  - as variables 377
  - using in C 377
- decimal floating-point support
  - built-in instructions, hardware 534
  - biased exponent definitions 542
  - FPC register-rounding macros 542
  - macros 542
  - Test Data Class masks 543
  - Test Data Group masks 543
- decimal.h header file 377
- declarations
  - and optimization
    - referencing bit fields 705
  - decimal 377
  - extern, using for linkage to other languages 239
- default
  - C locales for POSIX, SAA, and S370 1015
  - DCB attributes for SYSOUT data set 94
  - fopen() 34, 35
  - locales 1015, 1022
  - LRECL, fopen() 35
  - RECFM 34
- definition side-deck 293
- delete
  - named module from storage 826
  - optimizing 695
  - pipes with z/OS UNIX System Services file system 138
  - VSAM records 165
  - z/OS UNIX System Services file system files 135
- delimiter in JCL statements 93
- delivery, signals
  - ANSI C rules 410
  - asynchronous 412
  - POSIX rules 410
- differences among C, POSIX, and SAA
  - locales 1022
- digitsof operator 384
- direct processing 163
- directories (z/OS UNIX file system)
  - creating 128
  - deleting 135

- directories (z/OS UNIX file system)
  - (continued)
  - using 127
- disabled signals 414
- disjoint pragma 708
- DISP=MOD specification, DD statement
  - DDnames 37
  - OS I/O, fopen() modes 85
- DL/I (Data Language I) 935
- DLL code 301
- DLLs (Dynamic Link Libraries)
  - applications 282
  - binding a DLL 293
  - binding a DLL application 293
  - C example 309, 315, 316
  - C++ example 313
  - calling explicitly 284
  - calling implicitly 283
  - CICS 887
  - compatibility with non-DLL 305
  - Complex
    - assigning pointers 306
    - compatibility issues 305
    - creating 301
    - guidelines 303
    - modifying source 302
  - creating 290
    - C 290
    - description 290
    - export pragma 291
    - exporting functions 291
    - guidelines 303
  - entry point 297
  - example 296
  - freeing 290
  - load-on-call 283
  - loading 288
  - managing the use of 288
  - performance 299
  - restrictions 297
  - sharing among application executable files 290
  - using 294
- domain
  - AF\_INET 431
  - AF\_UNIX 432
- DSQCOMM.C header file 943
- DUMMY data set output 96
- dumps
  - requesting in the CEEBXITA assembler user exit 841, 845
- duplicate alternate index keys
  - retrieval sequence 162
  - under VSAM 160
- DWS (Data Window Services) 919
- DXFR, transfer control 905
- dynamic memory 777

## E

- EDCCB 448, 449
  - cataloged procedure 448, 449
  - changes for sockets 448, 449
  - sample 448, 449
- EDCDPLNK macro 373
- EDCDSAD macro 249, 254
- EDCDXD macro 373

- EDCEPIL macro 249, 250
- EDCLA macro 373
- EDCPRLG macro 249
- EDCPROL macro 249
- EDCRCINT routine 798
- EDCX4KGT routine 825
- EDCXABND routine 823
- EDCXABRT module
  - using during link edit 795
- EDCXABRT routine 798, 802
- EDCXCALL 249
- EDCXENV module 802
- EDCXENVL module 802
- EDCXEPLG 249
- EDCXEPLG macro 254
- EDCXEXIT module
  - exit(), system programming version 802, 807, 823
  - freestanding applications 798
- EDCXFREE routine 826
- EDCXGET routine 824
- EDCXHOTC library function 831
- EDCXHOTC routine 807
- EDCXHOTL library function 832
- EDCXHOTL routine 807
- EDCXHOTT library function 832
- EDCXHOTT routine 807
- EDCXHOTU library function 833
- EDCXHOTU routine 807
- EDCXISA module
  - entry point 795
  - in freestanding applications 798
- EDCXLANE module 827
- EDCXLANK module 827
- EDCXLANU module 827
- EDCXLOAD routine 826
- EDCXMEM module
  - freestanding applications 798
  - persistent environment 807
  - system programming memory management 802, 823
- EDCXPRLG 249
- EDCXPRLG macro 250
- EDCXREGS library function 833
- EDCXACC library function 834
- EDCXACC routine
  - accepting a request for service 822
- EDCXSPRT module
  - in freestanding applications 798
  - sprintf(), system programming version 807
  - sprintf(), system programming version of 802
  - System programming version of sprintf() 823
- EDCXSRC routine
  - xsrc library function 835
- EDCXSRVC routine 822
- EDCXSRVN routine
  - initiating a server request 822
- EDCXSTRL module
  - in freestanding applications 798
  - usage 794
- EDCXSTRT module
  - in freestanding applications 798
  - usage 793

- EDCXSTRX module
  - in freestanding applications 798
  - usage 794
- EDCXUNLD routine 826
- EDCXUSR library function 835
- EDCXUSR2 library function 835
- ELPA (Extended Link Pack Area) 370
- empty records
  - \_EDC\_ZERO\_RECLEN 18, 502
- enabled signals 414
- enclave
  - terminating with CEEAUE\_ABND 845
- encoded offset 117
- ENGLISH runtime messages 827
- Enhanced ASCII
  - limitations of 955
- environment
  - 64-bit 325
- environment variables
  - \_BPXK\_AUTOCVTS 467
  - \_BPXK\_CCIDS 468
  - \_BPXK\_PCCSID 469
  - \_BPXK\_SIGDANGER 470
  - \_CEE\_DLLLOAD\_XPCOMPAT 478
  - \_CEE\_DMPTARG 479
  - \_CEE\_ENVFILE 480
  - \_CEE\_ENVFILE\_S 481
  - \_CEE\_HEAP\_MANAGER 482
  - \_CEE\_RUNOPTS 484
  - \_EDC\_ADD\_ERRNO2 486
  - \_EDC\_ANSI\_OPEN\_DEFAULT 103, 487
  - \_EDC\_AUTOCVT\_BINARY 487
  - \_EDC\_BYTE\_SEEK 100, 117, 487
  - \_EDC\_C99\_NAN 489
  - \_EDC\_CLEAR\_SCREEN 197, 488
  - \_EDC\_COMPAT 488
  - \_EDC\_CONTEXT\_GUARD 489
  - \_EDC\_DLL\_DIAG 489
  - \_EDC\_EOVERFLOW 490
  - \_EDC\_ERRNO\_DIAG 491
  - \_EDC\_GLOBAL\_STREAMS 493
  - \_EDC\_IO\_ABEND 494
  - \_EDC\_IO\_TRACE 495
  - \_EDC\_OPEN\_CONCAT 497
  - \_EDC\_POPEN 497
  - \_EDC\_PTHREAD\_YIELD 497
  - \_EDC\_PTHREAD\_YIELD\_MAX 498
  - \_EDC\_PUTENV\_COPY 498
  - \_EDC\_RRDS\_HIDE\_KEY 499
  - \_EDC\_STOR\_INCREMENT 499
  - \_EDC\_STOR\_INCREMENT\_B 500
  - \_EDC\_STOR\_INITIAL 500
  - \_EDC\_STOR\_INITIAL\_B 501
  - \_EDC\_STRPTM\_STD 501
  - \_EDC\_SUSV3 501
  - \_EDC\_ZERO\_RECLEN 502
  - \_ICONV\_UCS2 1042
  - \_ICONV\_UCS2\_PREFIX 1036
- BIDIATTR 467
- BIDION 467
- locale 473
- naming conventions 476
- using 475
- EOF (end of file)
  - resetting terminal I/O 193



- equality operators
  - decimal in C 382
- ERRCOUNT runtime option 410
- errno values 1157
- errors, debugging 418
- ESCON channels, striped data sets 95
- ESDS (Entry-Sequenced Data Set)
  - alternate index keys 154
  - use of 151
- established signals 413
- examples
  - cnngas1 47
  - cnngbid1 1075
  - cnngca1 257
  - cnngca10 253
  - cnngca2 255, 257
  - cnngca3 257
  - cnngca5 256
  - cnngca6 263
  - cnngca7 266
  - cnngca9 253
  - cnngcc2 1055
  - cnngch1 405
  - cnngch2 406
  - cnngci1 882
  - cnngci3 896
  - cnngcl1 1008
  - cnngcl2 1009
  - cnngcl3 1010
  - cnngcp1 906
  - cnngcp2 908
  - cnngcp3 910
  - cnngcp4 911
  - cnngcp5 913
  - cnngcp6 914
  - cnngcp7 916
  - CCNGDB4 924
  - cnngdc1 381
  - cnngdc2 381
  - cnngdc3 392
  - cnngdc4 394
  - cnngdi1 226
  - cnngdi2 232
  - cnngdl1 1022
  - cnngdw1 920
  - cnngdw2 919
  - cnngec1 424
  - cnngcv1 502
  - cnnggd1 930
  - cnnggd2 932
  - cnnghc1 1133
  - cnnghf1 137
  - cnnghf2 139
  - cnnghf3 141
  - cnnghf4 145
  - cnngim1 937
  - cnngim2 939
  - cnngim3 940
  - cnngip1 1151
  - cnngip2 1154
  - cnngmf1 206
  - cnngmf2 208
  - cnngmf3 214
  - cnngmf4 214
  - cnngmi1 1141
  - cnngmi2 1141
  - cnngmt1 870

examples (continued)

- cnngmt2 871
- cnngmt3 872
- cnngmv1 1085
- cnngmv2 1086
- cnngof1 31
- cnngop1 729
- cnngop3 704
- cnngos1 87
- cnngos2 88
- cnngos3 113
- cnngos4 122
- cnngqm1 943
- cnngqm2 945
- cnngqm3 946
- cnngre1 371
- cnngre2 373
- cnngre3 374
- cnngre4 375
- cnngsp1 796
- cnngsp2 797
- cnngsp3 800
- cnngsp4 804
- cnngsp5 805
- cnngsp6 808
- cnngsp7 810
- cnngsp8 814
- cnngsp9 816
- cnngspa 824
- cnngspb 825
- cnngspc 826
- cnngspd 817
- cnngspe 819
- cnngspf 820
- cnngth1 360
- cnngvs1 154
- cnngvs2 177
- cnngvs3 184
- cnngvs4 187
- cnngwt1 1149
- cnngwt2 1150
- cnngci2 891
- machine-readable xxxiii
- naming of xxxiii
- softcopy xxxiii
- using DB2 with C 924
- exception handling
  - C exceptions under C++ 404
  - C-IMS 936
  - C++-IMS 936
  - CEEBXITA assembler user exit 842
  - decimal type 394
  - description 403
  - hardware exceptions under C++ 404
  - optimizing 695
- EXEC CICS commands
  - FREEMAIN 888
  - GETMAIN 888
  - how to use 880
  - LINK 887
  - RETURN 888
  - WRITEQ TD 228
  - XCTL 887
- exec family of functions
  - data definition considerations 131
  - described 720

- EXECUTE extended parameter list
  - request 261
- execution\_frequency pragma 708
- EXH compiler option 726
- export pragma 708
- EXPORTALL compiler option 726
- exporting functions 282
- exporting source to other sites 1062
- expressions, optimizing
  - recommendations 703
- extended parameter list 259
- extern declaration
  - using for linkage to other languages 239
- external
  - static 370
  - variables 702, 706

## F

- F-format records 12
- families
  - address 429
  - socket 428
- fclose() library function
  - \_EDC\_COMPAT environment variable 488
- fcntl() library function 128
- fdelrec() library function
  - using to delete records 156, 165
- feature model 551
- fetch() library function
  - and writable statics 367
  - calling other z/OS XL C/C++ modules in C 707
  - system programming C environment 791
  - under CICS 887
- fflush() library function
  - \_EDC\_COMPAT environment variable 488
  - optimizing code 720, 721
- fgetpos() library function
  - \_EDC\_COMPAT environment variable 488
  - optimizing code 720
- fgets() library function
  - optimizing code 719
- fgetwc\_unlocked() library function 55
- fgetwc() library function 54
- fgetws\_unlocked() library function 55
- fgetws() library function 55
- FIFO
  - mkfifo() 136, 137
  - special files
    - creating 128
    - using 127, 137
- File I/O trace 234
  - Locating the file I/O trace 234
  - Sample file I/O trace 234
- files
  - conversion 149
  - large support 144
  - memory
    - closing 212
    - extending 211
    - flushing 210

- files (*continued*)
  - memory (*continued*)
    - opening 202
    - positioning 211
    - reading 209
    - repositioning 211
    - writing 210
  - named pipe 137
  - origin of OS attributes 103
  - OS
    - flushing 112
    - opening 83
    - reading from 105
    - removing 123
    - renaming 123
    - repositioning 115, 120
    - writing to 107
  - tagging 149
  - VSAM
    - closing 176
    - deleting a record 165
    - flushing 168
    - locating a record 165
    - reading a record 162
    - repositioning 165
    - updating a record 164
    - writing a record 163
  - z/OS, opening 83
- filetag pragma 1053
- fixed-format records
  - overview 12
  - standard format 12
- fixed-point data types 377
- fixes
  - ++PTF statement 1162, 1163
  - shipping 1162, 1163
- fldata() library function
  - memory file I/O 212
  - OS I/O files 123
  - terminal I/O 199
  - z/OS UNIX System Services file system I/O 147
- floating-point registers 258
- floating-point support
  - binary 545
  - built-in instructions 533
  - decimal 534
  - hexadecimal 544
- flocate() library function
  - VSAM data sets 154, 166
- flushing
  - binary streams, wide character I/O 59
  - buffers for terminal files 197
  - memory files 210
  - OS I/O files 112
  - terminal files 197
  - text streams, wide character I/O 58
  - the CELQPIPI MSGRTN file 219
  - VSAM data sets 168, 174
  - z/OS Language Environment message file 218
  - z/OS UNIX System Services file system records 134
- fopen() library function
  - list of parameters, for memory file I/O 203

- fopen() library function (*continued*)
  - list of parameters, for (*continued*)
    - terminal I/O 192
    - VSAM I/O 158
    - z/OS OS I/O 97
    - z/OS UNIX System Services file system I/O 131
  - restrictions 34
  - under MTF 876
  - z/OS UNIX System Services file system files 128
- for statement 705
- fork() library function
  - data definition considerations 131
  - using with memory files 720
- form feed escape sequence \f 109
- Format-D files restriction 11
- fputc() library function
  - optimizing code 719
- fputs() library function
  - optimizing code 719
- fputc\_unlocked() library function 56
- fputwc() library function 56
- fputws\_unlocked() library function 56
- fputws() library function 56
- fread() library function
  - optimizing code 719, 721
- FREE=CLOSE parameter, DD statement 86
- freestanding applications
  - EDCXISA 795
  - EDCXSTRL 794
  - EDCXSTRT 793
  - EDCXSTRX 794
- freopen() library function
  - noseek parameter
    - in-stream data sets 93
  - under MTF 876
  - VSAM data sets 156
  - warning 37
  - z/OS UNIX System Services file system files 128
- fseek() library function
  - \_EDC\_COMPAT environment variable 488
  - optimizing code 719
- fsetpos() library function
  - optimizing code 720
- fstream class 24
- ftell() library function
  - \_EDC\_COMPAT environment variable 488
- full buffering 45
- function prototypes
  - default linkage 242
- functions
  - arguments 702
  - calling
    - prototyped and non-prototyped 389
  - descriptors 281
  - exported 282
  - imported 282
- fupdate() library function 156, 164
- fwprintf\_unlocked() library function 56
- fwprintf() library function 56

- fwrite() library function
  - optimizing code 719, 721
- fwscanf\_unlocked() library function 55
- fwscanf() library function 55

## G

- GDDM (Graphical Data Display Manager)
  - interface 929
  - with z/OS XL C/C++ 929
- GDG (Generation Data Group)
  - C example 87
  - C++ example 88
  - input and output 87
- genxlt utility 1023
- getenv() library function 475
- getsyntax() library function 952
- getwc\_unlocked() library function 55
- getwc() library function 55
- getwchar\_unlocked() library function 55
- getwchar() library function 55
- global assembler user exit 839
- global variables 701
- graph coloring register allocation 724
- graphics support 929

## H

- hard-coding 1049
- hardware built-in functions 505
- hardware model 551
- hardware signals 414
- header files
  - decimal.h 377
- HEAP runtime option
  - system programming C environment 791
- hexadecimal floating-point support
  - built-in instructions, hardware 544
- hexadecimal values
  - code point mappings 1089
  - keyboard, mapping variant characters 1083
- HGPR compiler option 726
- high-level
  - qualifier
    - defaults 85, 203
    - running without RACF 85, 203
    - setting the user prefix under TSO 85, 203
- hiperspace memory files
  - I/O, description 31
  - input and output 201
  - POSIX restrictions 32
  - specifying buffer size, setvbuf() 201
- horizontal tab escape sequence \t 109
- HOT compiler option 726
- hybrid coded character set, using 1049

## I

- I/O
  - binary stream 8
  - blocked 8
  - card input and output 96

- I/O (*continued*)
  - category descriptions
    - CICS data queues 32
    - hiperspace memory files 31
    - memory files 31
    - OS files 30
    - terminal 30
    - UNIX file system files 30
    - VSAM files 30
    - z/OS Language Environment
      - message files 32
  - CICS 215, 884
  - debugging 223
  - DUMMY data set output 96
  - errors 223
  - hiperspace memory files 201
  - in-stream data sets 93
  - low-level z/OS UNIX System
    - Services 141
  - memory file 201
  - multivolume data sets 95
  - object-oriented 23
  - optical reader input 96
  - OS 83
  - pipe 136
  - printer output 96
  - record
    - introduction 8
    - model 11
    - rules, z/OS UNIX System Services
      - file system 132
  - striped data sets 95
  - summary table 29
  - sysout data set 93
  - tapes 94
  - terminal 191
  - text stream 7
  - wide characters 53
  - z/OS Language Environment message
    - file 217
  - z/OS UNIX System Services file
    - system 127
    - functions 141
    - using with I/O 127
- i/o stream libraries
  - optimizing 721
- I/O Stream Library 63
- I/O Streams File I/O 23
- IBM-1047 (APL 293), CICS 879
- IBM-1047 character set
  - converting to a specific character
    - set 1133
- IBM-1047 coded character set
  - CCNGHC1 1133
  - converting code to 1051
- iconv utility
  - converting code sets 1023
  - preparing source code for
    - exporting 1062
- iconv() library function 1024
- IEBGGENER utility (TSO)
  - tape files 94
- IEEE Binary Floating-Point 397
- IEEE Decimal Floating-Point 397
- IEFUSI exit routine
  - MEMLIMITvalue 332
- if statement 705
- ifstream class 24
- IGNERRNO compiler option 726
- ILP32
  - and LP64 325
- ILP32 to LP64 migrations 351
  - alignment differences 333
  - alignment issues 332
  - assignment issues 337
  - availability of suboptions 332
  - conditional compiler directives 351
  - conversions between int and
    - pointer 342
  - converters 351
  - customized locales 351
  - debugging 350
  - ensuring portability 329
  - explicit types 348
  - function prototypes 350
  - header files 341, 348
  - localedef utility 351
  - locales 351
  - LONG\_MAX 347
  - padding 349
  - pointer cast conversions 343
  - pointer declarations 341
  - portability issues 331, 338
  - portable coding 348
  - post-migration activities 328
  - pre-migration activities 328
  - precision 343
  - SAA 351
  - shared structures 344, 349
  - suffixes 348
  - type definitions 348
  - unsuffixed numbers 346
- IMEM LIM variable
  - to override the MEMLIMIT
    - default 332
- IMS (Information Management System)
  - default high-level qualifier 85, 203
  - error handling 936
  - opening files 85, 203
  - other considerations 936
  - redirecting standard streams 74
  - using with CICS 887
  - with z/OS XL C/C++ 935
  - z/OS UNIX System Services 1155
- in-stream data sets
  - delimiter for data 93
  - input 93
  - noseek parameter 93
- include files
  - with z/OS UNIX System Services
    - sockets 447
- INCLUDE statement, MVS 840
- INFO compiler option
  - ensuring portability to LP64 329
- INIT token preinitialization 260
- initialization
  - nested enclave
    - CEEBXITA's function code
      - for 843
    - using CEEBXITA 840
- inlining
  - optimization 728
  - suggestions 729
  - under IPA 731
- installation-wide assembler user exit 839
- instruction scheduling 724
- integer constants
  - 64-bit 343
- interface
  - CICS 879
  - DB2 921
  - DWS 919
  - GDDM 929
  - IMS 935
  - locale-sensitive 952
  - preinitialized program 259
- interlanguage calls
  - C or C++ and assembler 245
  - linkage specification 242
  - using linkage specifications 239
- interleaving
  - standard streams 65
  - without sync\_with\_stdio() 66
- international enabling
  - for programming languages 951
  - z/OS XL C/C++ support for 952
- internationalization
  - display of hexadecimal values 1083
- Internet address 430
- internetworking concepts 425
- interprocess communication
  - asynchronous signal delivery 412
  - z/OS TCP/IP considerations 446
- INTRDR, using to create job stream
  - within a program 94
- ios class 23
- iostream
  - optimizing 695
- iostream header file 23
- iostream.h header file 23
- IPA
  - compiler option 727
  - flow of processing
    - IPA 735
    - IPA Compile step 736
    - IPA Link step 737
    - non-IPA 735
- IPA(LINK) compiler option
  - as of z/OS V1R8 XL C/C++ 332
- isalnum() macro 717
- isalpha() macro 717
- ISAM data sets, restriction 83
- ISASIZE runtime option
  - system programming C
    - environment 791
- iscics() library function 887
- iscntrl() macro 717
- isdigit() macro 717
- ISearchByExample 1063
- isgraph() macro 717
- islower() macro 717
- isolated\_call 709
- isprint() macro 717
- ispunct() macro 717
- isspace() macro 717
- isupper() macro 717
- isxdigit() macro 717

## J

JCL procedures  
64-bit virtual memory 332  
setting MEMLIMIT value 332

## K

KANJI runtime messages 827  
keyboard  
navigation 1165  
PF keys 1165  
shortcut keys 1165  
keyboard, mapping variant  
characters 1083  
KSDS (Key-Sequenced Data Set)  
alternate index, under VSAM 154  
description 151

## L

LANGLVL(EXTENDED) compiler  
option 377  
large format sequential data sets 96  
Latin-1/Open Systems coded character  
set IBM-1047  
code point mappings for hexadecimal  
values 1089  
LC\_ALL locale variable 964  
LC\_COLLATE locale variable 964  
LC\_CTYPE locale variable 964  
LC\_MONETARY locale variable 964  
LC\_NUMERIC locale variable 964  
LC\_SYNTAX locale variable 986  
LC\_TIME locale variable 964  
LC\_TOD locale category 1013  
LC\_TOD locale variable 964  
leaves pragma 709  
LIBANSI compiler option 727  
library extensions 707  
packaging 1161  
library lookasides  
optimizing 779  
line buffering 45  
linear data sets 151  
link edit 448  
link files (z/OS UNIX file system),  
creating 128  
link pack areas  
optimizing 779  
link() library function 128  
linkage editor, CICS 879  
linkage pragma for interlanguage  
calls 258  
linking  
case sensitivity 242  
CSECT compiler option 1162  
for packaging products 1162  
function prototypes 242  
kinds of linkage 240  
sockets programs 444  
syntax 239  
TARGET compiler option 1162  
listen(), network example 433  
listings, locale sensitive 1058  
loading  
named module into storage 826

loading (*continued*)  
VSAM data sets 163  
local  
constant propagation 723  
expression elimination 723  
variables 701  
localdtconv() library function 952  
locale  
ASCII method files 989, 1107  
C 1015  
categories  
LC\_ALL 964  
LC\_COLLATE locale variable 964  
LC\_MONETARY locale  
variable 964  
LC\_NUMERIC locale variable 964  
LC\_SYNTAX locale variable 986  
LC\_TIME locale variable 964  
LC\_TOD locale variable 964  
LC\_TYPE locale variable 964  
CICS support 879  
compiler option examples 1057, 1058  
converting existing work 1063  
customizing 1005  
environment variables 473  
generating an object module 1058  
hybrid coded character set,  
using 1049  
library functions  
localdtconv() 952  
localeconv() 952  
setlocale() 952  
LOCALE compiler option 1057  
localeconv() library function 964  
macros 1054  
overview of z/OS XL C/C++  
support 952  
predefined 1056  
source-code functions summary 1053  
summary of support in  
compiler 1058  
tests for SAA or POSIX 1022  
TZ or \_TZ environment  
variable 1013  
using with CICS 886  
LOCALE compiler option 1057  
display of hexadecimal values 1083  
localeconv() library function 952  
localedef utility 351  
example 1121  
locales  
display of hexadecimal values 1083  
under ILP32 and LP64 351  
locales, customized 351  
loop optimization 765  
loop statements, optimizing 704  
low-level z/OS UNIX System Services  
I/O 141  
LP64  
and ILP32 325  
LP64 environment  
advantages and disadvantages 326  
application performance and program  
size 326  
migrating applications to 327  
pointer assignment 342  
restrictions 327

LP64 strategy 327  
LPA (Link Pack Area) 370  
LRECL (logical record length) parameter  
defaults 35  
fopen() library function  
memory file I/O 204  
terminal I/O 192  
VSAM data sets 159  
z/OS OS I/O 99  
lrecl=X, OS I/O 99

## M

m\_create\_layout() library function 1068  
m\_destroy\_layout() library  
function 1071  
m\_getvalues\_layout() library  
function 1069  
m\_setvalues\_layout() library  
function 1069  
m\_transform\_layout() library  
function 1069  
m\_wtransform\_layout() library  
function 1071  
machine print-control codes 12  
macros  
EDCDSAD 249  
EDCEPIL 249  
EDCPRLG 249  
EDCPROL 249  
EDXCALL 249  
EDCXEPILG 249  
EDCXPRLG 249  
use with locale 1054  
main task for MTF 855  
mainframe  
education xxxiii  
malloc() library function  
system programming C  
environment 802, 807, 823  
MASS libraries  
compiling and linking programs 749  
scalar functions 741  
SIMD functions 748  
vector functions 744  
MB\_CUR\_MAX, effect on DBCS 53  
member, PDS and PDSE 89  
memcmp library function 717, 718  
MEMLIMIT default value  
64-bit virtual memory 332  
overriding 332  
setting 332  
memory  
optimizing 777  
memory files  
automatic name generation 205  
closing 212  
example 31, 214  
example program 213  
extending 211  
flushing 210  
I/O, description 31  
in hyperspace 201  
input and output 201  
opening 202  
optimizing 721  
positioning within 211

- memory files (*continued*)
  - reading from 209
  - repositioning within 211
  - return values for `fldata()` 212
  - simulated partitioned data sets
    - description 206
    - example 206, 208
  - specifying asterisk as file name 205
  - support under CICS 885
  - text mode treated as binary 205
  - `ungetc()` considerations 211
  - using to optimize code 721
  - writing to 210
- `memset` library function 717
- method files 989, 1107
- migrating applications
  - from ILP32 to LP64 327
- migration issues, ILP32-to-LP64 331
- `mkdir()` library function 128
- `mkfifo()` library function
  - with z/OS UNIX System Services file system files 128, 136, 137
- `mknod()` library function 128, 137
- MSGCLASS, matching for SYSOUT data sets 94
- MSGFILE (z/OS Language Environment)
  - closing 218, 220
  - default destination SYSOUT 73
  - flushing buffers 218, 219
  - opening files 217, 219
  - output 217
  - reading from 217, 219
  - repositioning within 218, 219
  - writing to 218, 219
- MTF (multitasking facility)
  - coding for 863
  - compiling 872
  - concepts illustrated 858
  - DD statements 874
  - designing for 863
  - dynamic commons 869
  - EDCMTF5 873
  - examples 867
  - independence requirement 863
  - introduction to 855
  - Job Control Language (JCL) 873, 875
  - link-editing considerations 874
  - linking 872
  - load modules 872
  - modifying runtime options 874
  - multithreading 367
  - passing data 865
  - restrictions 875
  - rules 864
  - running under 874
  - tasks 855
  - with z/OS XL C/C++ 787
- multibyte characters 53
  - effect of MB\_CUR\_MAX 53
  - reading 54
  - writing 56
- multiple buffering 102
- multiple invocations, preinitialized
  - program 258
- multiple threads 353
- multiplicative operators, decimal 381
- multithreading 765

- multivolume data sets, opening 95
- mutex 355
- MVS (Multiple Virtual System)
  - alternative initialization routine 793
  - building freestanding applications 795
  - Data Window Services (DWS) 919
  - file names 83
  - file names for memory files 202
  - listing PDS members 1150
  - reentrant modules 796
- MVS data sets
  - optimizing 719

## N

- named pipes
  - example 139
  - using 137
- naming environment variables 476
- natural reentrancy 369
  - and XPLINK 370
- navigation
  - keyboard 1165
- NCP subparameter
  - multiple buffering 102
- network byte order 430
- network communication basics 426
- network, application example 437
- new
  - optimizing 695
- newline escape sequence `\n` 109
- `nl_langinfo()` library function 952
- NOARGPARSE runtime option 262
- non-DASD devices, I/O 96
- Non-VSAM keyed data sets,
  - restriction 83
- nonoverrideable runtime options in the
  - user exit 845
- NOSEEK parameter
  - in-stream data sets 93
  - memory file I/O 204
  - sequential concatenations 92
  - terminal I/O 193
  - VSAM data sets 160
  - z/OS OS I/O 100
- Notices 1169

## O

- object-oriented model for I/O 23
- OBJECTMODEL compiler option 727
- `ofstream` class 24
- Open Socket 425
- `open()` library function
  - for low-level z/OS UNIX System Services files 128
  - with pipes 137
  - z/OS UNIX System Services file system files 128
- opening
  - CICS data queues 32
  - determining type of file to open 29
  - files for I/O, overview 27
  - memory files
    - description 31
- opening (*continued*)
  - memory files (*continued*)
    - example 31
  - memory I/O files 202
  - multibyte character files 54
  - OS files 30
  - terminal files 191
  - terminal I/O files 30
  - the CELQPIPI MSGRTN file 219
  - UNIX file system files 30
  - VSAM data sets 30, 156
  - z/OS Language Environment message files 32, 217
  - z/OS UNIX System Services file system files 129
- OpenMP directives 765
- operators, decimal
  - arithmetic 381
  - assignment 383
  - cast 385
  - summary 385
  - unary 383
- optica/reader input 96
- optimization
  - accessing UNIX file system files 721
  - additional compiler options 725
  - ANSI aliasing 697
  - application performance 781
  - arithmetic constructions 704
  - ATLAS libraries 753
    - description and functionality 753
    - example 1 755
    - example 2 762
    - libraries and header files 754
    - related external information 763
    - required options 755
  - built-in functions
    - examples 717
  - C++ 695
  - code motion 724
  - common expression elimination 724
  - compilation time 781
  - constant propagation 724
  - control constructs 704
  - conversions 704
  - dead code elimination 724
  - dead store elimination 724
  - declarations 705
  - dynamic memory 777
  - expressions 703
  - fixed standard format records 12
  - function arguments 702
  - general notes 695
  - graph coloring register allocation 724
  - high performance libraries 741
  - i/o stream libraries 721
  - inlining 728, 729
  - inlining under IPA 731
  - instruction scheduling 724
  - levels 732
  - library extensions 707
  - library lookasides 779
  - link pack areas 779
  - loop statements 704
  - loops 765
  - MASS libraries 741
  - memory 777



- optimization (*continued*)
  - memory files 721
  - MVS data sets 719
  - noseek parameter for OS I/O 101
  - OPTIMIZE 723
  - pointers 702
  - programming recommendations 12
  - referencing bit fields 705
  - storage 777
  - straightening 724
  - strength reduction 724
  - value numbering 723
  - variables 701
  - virtual lookasides 779
  - XPLINK 731
- OPTIMIZE
  - optimizing 723
- optimized code
  - troubleshooting with dbx 785
- option\_override 709
- order, network byte 430
- OS I/O
  - acc= parameter 100
  - asis parameter 100
  - asynchronous reads 101, 102
  - asynchronous writes 101, 102
  - buffering 101
  - byteseek parameter 100
  - closing files 120
  - description 30
  - fgetpos() and ftell() values 117
  - flushing records
    - description 112
    - example 113
  - I/O stream library 83
  - in-stream data sets 93
  - lrecl=X 99
  - multivolume data sets 95
  - opening files 83
  - overview 83
  - password= parameter 100
  - PDS and PDSE considerations
    - BLKSIZE values 99
    - LRECL values 99
    - overview 89
    - RECFM values 98
  - reading from files 105
  - repositioning within files 115
  - space= parameter 99
  - striped data sets 95
  - tapes 94
  - type= parameter 100
  - ungetc() considerations 114, 116
  - writing to files 107
- OS linkage 239, 246, 258
- os parameter, fopen()
  - memory file I/O 204
  - terminal I/O 193
  - VSAM I/O 160
  - z/OS OS I/O 101
- overlapped I/O 102
- overrideable runtime options in the user
  - exit 845

## P

- packaging products 1161
  - ++MOD method 1162
  - ++PROGRAM method 1163
  - DLL compiler option 1162
  - final testing 1163
  - for changes during servicing 1162
  - IPA compiler option 1162
  - LONGNAME compiler option 1162
  - prelinker output 1162
  - RENT compiler option 1162
  - under z/OS UNIX System
    - Services 1162
- packed decimal
  - assignments 379
  - conversions 385
  - declarations 377
  - operators 380
  - using with CICS 886
  - variables 378
- parallel functions 856
- parallelization 765
  - OpenMP directives 765
  - shared and private variables 766
  - shared memory parallelism
    - (SMP) 713
- parameter list, OS 246
- partitioned concatenation
  - compatibility rules 91
  - data sets 91
- passing parameters
  - CSP 905
  - OS 246
- passing streams across system calls 75
- password= parameter
  - memory file I/O 204
  - VSAM data sets 160
  - z/OS OS I/O 100
- PATH, under VSAM 154
- pathname, under POSIX.1 129
- PDF documents xxxii
- PDS (partitioned data set)
  - input and output 89
  - listing members 1150
  - memory files simulation
    - description 206
    - example 206, 208
    - opening 98
    - OS I/O, restriction on opening 90
- PDSE (partitioned data set extended)
  - input and output 89
  - opening 98
  - OS I/O, restriction on opening 90
- performance
  - impact from BYTESEEK mode for OS
    - files 117
  - improvements by using fixed standard
    - format records 12
  - memory files 201
  - noseek parameter for OS I/O 101
  - opening memory files 205
  - specifying FBS format 99
- persistent C environments 802
- pipe() library function 128
- pipes
  - creating 128
  - I/O 136

- pipes (*continued*)
  - named 137
  - unnamed 136
    - description 128
    - example 137
- PL/I
  - using linkage specifications 239
- PLIST
  - system programming
    - environment 791
- plotters, Graphical Data Display Manager
  - (GDDM) 929
- pointer assignments
  - under LP64 342
- pointers 306
  - 64-bit 341
  - assigning in DLLs 306
  - optimization 702
- portability
  - between ILP32 and LP64 348
  - from ILP32 to LP64 329
  - ILP32-to-LP64 issues 331
  - INFO 329
  - long and int 338
  - VM/CMS and z/OS filenames 85
  - WARN64 330
- portable character set 1047, 1079
- ports
  - description 430
  - locating 437
- positioning
  - memory files 211
  - OS I/O files 115
  - terminal files 198
  - the CELQPIPI MSGRTN file 219
  - z/OS Language Environment message
    - file 218
  - z/OS UNIX System Services file
    - system files 134
- POSIX
  - character set 1079
  - locale, defined 1015
  - POSIX C locale and SAA C locale
    - differences 1021, 1022
- pragma
  - omp 765
- pragmas
  - convert 1061
  - disjoint 708
  - environment 798, 801
  - execution\_frequency 708
  - export 708
  - filetag
    - ??=pragma filetag directive 1053
  - inline 709
  - isolated\_call 709
  - leaves 709
  - linkage 795
  - noinline 709
  - option\_override 709
  - reachable 709
  - runopts
    - description 827, 828
    - heap 874
    - plist 791
    - stack 874
  - strings 709

- pragmas (*continued*)
  - unroll 709
  - variable 709
    - NORENT 369
    - RENT 369
  - with XPLINK and SQL 922
- precision of operator 384
- predefined locale 1056
- PREFETCH compiler option 727
- preinitialization
  - ARGPARSE runtime option 262
  - CALL token 260
  - example 263
  - INIT token 260
  - TERM token 261
  - z/OS 268
- presentation interface 929
- printer output
  - Graphical Data Display Manager (GDDM) 929
- printf
  - 64-bit 347
- problem determination
  - location of compile-time options information 687
  - run time 687
  - stepping through optimized code using dbx 785
- protocols, transport 426
- putc() library function
  - optimizing code 719
- putwc\_unlocked() library function 56
- putwc() library function 56
- putwchar\_unlocked() library function 56
- putwchar() library function 56

## Q

- QMF (Query Management Facility)
  - with has SAA callable interface 943

## R

- RACF (Resource Access Control Facility)
  - no hyphens in names for 84
  - qualifier required in data set name 85
- raise() library function
  - error handling 409
- RBA (Random Byte Address)
  - in VSAM 154
- RDW (record descriptor word) 98
- reachable pragma 709
- read-write lock 355
- read() library function
  - with pipes 137
  - z/OS UNIX System Services file system files 133
- reading
  - from memory files 209
  - from OS I/O files 105
  - from terminal files 193
  - from the CELQPIPI MSGRTN file 219
  - from the z/OS Language Environment message file 217

- reading (*continued*)
  - from VSAM data sets 162
  - from z/OS UNIX System Services file system files 133
  - multibyte characters 54
  - using recfm=U 98
- realloc() library function
  - system programming C environment 807, 823
- reason codes
  - in user exits 844
- RECFM (record format)
  - F (fixed-format) 12
  - memory file I/O 204
  - overview 11
  - RECFM defaults 34
  - recfm=\* extension 33, 98
  - recfm=A extension 98
  - restrictions 36
  - S (fixed standard) 12
  - S (variable spanned) 17
  - specifying 33
  - terminal I/O 192
  - U (undefined format)
    - overview 19
    - reading OS files 98
  - V (variable format)
    - overview 16
  - VSAM data sets 159
  - z/OS OS I/O 98
- record
  - empty
    - \_\_EDC\_ZERO\_RECLEN 18, 502
  - files, using fseek() and ftell() 119
  - fixed standard format 12
  - I/O
    - byte stream behavior 21
    - fixed-format behavior 15
    - introduction 8
    - restriction 54
    - undefined-format behavior 20
    - variable-format behavior 18
  - spanned 17
  - specifying length 33
  - undefined-length 19
  - variable-length 16
  - z/OS UNIX System Services file system I/O rules 132
  - zero-byte
    - \_\_EDC\_ZERO\_RECLEN 18, 502
- redirection
  - standard streams 63
    - introduction 72
    - to fully qualified data sets 72
    - using DD statements 72
    - using freopen() 72
    - using PARM 72
  - standard streams in a system programming C environment 791
  - stderr, with z/OS Language Environment MSGFILE option 70
  - stream, using assignment 70
  - streams under CICS 75
  - streams under IMS 74
  - streams under TSO
    - from the command line 74
    - introduction 74

- redirection (*continued*)
  - streams, using freopen() 70
  - symbols 69
- reentrancy
  - and XPLINK 370
  - constructed 370
  - in z/OS XL C/C++ 369
  - limitations 370
  - modified CEEBXITA must be reentrant 842
  - natural 370
  - with respect to CICS 894
- register
  - allocation 724
  - conventions 258
  - variables 702
- regular z/OS UNIX System Services file system files 127
- relational operators
  - decimal in C 381
- relative byte offset 117
- release changes xxxv
- remove() library function
  - memory I/O files 212
  - OS I/O files 123
- rename() library function
  - OS I/O files 123
- RENT compiler option 369
- repositioning
  - binary streams, wide character I/O 60
  - memory files 211
  - OS I/O files 115
  - terminal files 198
  - text streams, wide character I/O 59
  - the CELQPIPI MSGRTN file 219
  - VSAM records 165
  - z/OS Language Environment message file 218
  - z/OS UNIX System Services file system files 134
- RESTRICT compiler option 727
- restrictions, compiler 445
- retaining for multiple invocations
  - assembler to C repeatedly 258
  - preinitialized program 258
- return
  - codes
    - \_\_amrc structure 177
    - CEEAEUE\_RETC field of CEEBXITA and 843
    - in user exits 843
    - value under CICS 888
- RMODE processing option
  - for CEEBXITA user exit 842
- ROCONST compiler option 727
  - controlling external static 370
- ROSTRING compiler option 728
  - controlling writable strings 371
- RPC (Remote Procedure Call) 446
- RRDS (Relative Record Data Set)
  - choosing whether key and data are contiguous 162
  - choosing whether key is returned with data on read 163
  - key structure 161
  - related environment variable 499

RRDS (Relative Record Data Set)  
(*continued*)

use of 151

RRN (Relative Record Number)  
under VSAM 155

RTTI

optimizing 695

RTTI compiler option 728

runtime

messages

EDCXLANE 827

EDCXLANK 827

UENGLISH 827

options

in the user exit 841, 845

TRAP 841, 842, 845

user exits 837

runtime environment

changing the code page 1083

Runtime type identification

optimizing 695

## S

S370 locale 1015

SAA (Systems Application Architecture)

applications using QMF callable

interface 943

differences between C and POSIX

locales 1021, 1022

locale 1015

saved options information 687

saved options information layout 688

screen layouts 929

SEEK\_CUR macro

effects of ungetc() 117

effects of ungetwc() 60

seeking

OS I/O files 115

terminal files 198

the CELQPIPI MSGRTN file 219

within memory files 211

within z/OS UNIX System Services

file system files 134

z/OS Language Environment message

file 218

select(), network example 434

sending comments to IBM xxxiv

sequential

concatenation

compatibility rules 91

data sets 91

noseek parameter 92

processing 162, 163

sequential data sets, large format 96

server

allocation with socket() 433

locating the port 437

perspective 433

service routines 807

session

typical TCP socket 435

typical UDP socket 436

setenv() library function

setting environment variables 475

setlocale() library function

description 952

setlocale() library function (*continued*)

not thread-safe 367

setvbuf() library function

hiperspace memory files 45, 201

specifying size of buffer for

hiperspace 201

usage 721

zFS file systems 721

severity of a condition

CEEBXITA assembler user exit

and 844

shaping characters 1066

shared programs 369

shareoptions specification, VSAM

deleting records 164

opening a data set 158

shift-in character (DBCS) 109

shift-out character (DBCS) 109

shortcut keys 1165

SIGABND signal 414

SIGABRT signal 414

SIGDANGER signal 415

SIGDUMP signal 415

SIGFPE signal

error condition 414

under decimal 383

SIGILL signal 414

SIGINT signal 414

SIGIOERR signal 231, 414

signal

actions, defaults 418

delivery

ANSI C rules 410

asynchronous 412

POSIX rules 410

handling

default 418

disabled 414

enabled 414

established 413

hardware 414

raise 409

software 414

with signal() and raise() 409

with z/OS Language

Environment 409

SIGSEGV signal 414

SIGTERM signal 414

SIGUSR1 signal 414

SIGUSR2 signal 414

size of operator 384

SMP/E

packaging considerations 1161

socket

address 430

address families 429

addressing within 429

AF\_INET domain 431

AF\_UNIX domain 432

client perspective 435

compiling 444

data sets 447

datagram 429

defined 425, 427

domains 429

families 428

include files 447

socket (*continued*)

Internet 425

linking 444

local 425

types

datagram 428

guidelines for using 429

stream 428

typical TCP session 435

typical UDP session 436

using over TCP/IP 425

z/OS TCP/IP 446

z/OS UNIX System Services

specific 428

software signals 414

space= parameter

memory file I/O 204

terminal I/O 192

VSAM data sets 159

z/OS OS I/O 99

spanned records 17

SPIII compiler option 728

spool data sets 488

sprintf() library function

in freestanding routines 796

system programming C

environment 802, 807, 823

square brackets ([ and ])

displaying on workstation or

3270 1083

displaying square brackets 1086

square brackets 1086

sscanf() library function

character to integer conversions 718

stand-alone modules 792

standalone CICS translator 899

standard

records 12

stream

association with ddnames 73

cerr 23

cin 23

clog 23

cout 23

default open modes 64

direct assignment 70

global behavior 78, 493

interleaving 65

interleaving without

sync\_with\_stdio() 66

passing across a system() call 75

redirecting 63

redirection to fully qualified data

sets 72

redirection under MVS 72

restrictions in threaded

applications 365

stderr 63

stdin 63

stdout 63

support under CICS 884

using 63

standard error, redirecting 63

standard in, redirecting 63

standard out, redirecting 63

static variables 701



STDERR  
 redirecting with z/OS Language Environment MSGFILE option 70  
 stdin, C standard input stream 63  
 stdout, C standard output stream 63  
 STEPLIB DD statement 874  
 stepping through optimized code using dbx 785  
 storage  
 allocating with the system  
 programming C environment 790  
 freeing with EDCXFREE 826  
 getting with EDCXGET 824  
 optimizing 777  
 page-aligned, getting with EDCX4KGT 825  
 under CICS 888  
 Store Clock Fast  
 built-in instruction 505  
 straightening 724  
 strcat() library function 718  
 stream sockets 428  
 streambuf class 23  
 streams, orientation of 53  
 strength reduction 724  
 STRICT compiler option 728  
 STRICT\_INDUCTION compiler option 728  
 strings  
 comparisons 717, 718  
 pragma 709  
 processing 718  
 striped data sets 95  
 strlen library function 717  
 structure alignment  
 64-bit 332  
 structure comparison 717  
 structures  
 ILP32 to LP64 alignment problems 344  
 rule of alignment 333  
 stub routines  
 in a user-server environment 822  
 svc99() library function 887  
 symbolic link (z/OS UNIX System Services file system) files, creating 128  
 syntax diagrams  
 how to read xxv  
 SYSERR data set  
 with stdout 64, 73  
 SYSIN data set for stdin  
 description of 64, 73  
 SYSOUT data set  
 DCB attributes, defaults 94  
 default destination for z/OS Language Environment MSGFILE 73  
 output 93  
 SYSPRINT data set  
 with stdout 64, 73  
 system  
 exit routines 798  
 functions  
 built-in 790  
 memory management 790  
 programming facilities  
 additional library routines 828

system (continued)  
 programming facilities (continued)  
 building persistent C environments 802, 803  
 building system exit routines 799  
 building user-server environments 822  
 freestanding applications 792  
 runtime messages 827  
 tailoring the environment 823  
 with z/OS XL C++ 787  
 System Programming Calls  
 restrictions 394  
 system() library function  
 CICS 887  
 library extension 708  
 programming C environment 791  
 SYSTEMM data set  
 with stdout 64, 73

## T

tab, horizontal 109  
 tab, vertical 109  
 tapes  
 input and output 94  
 multivolume data sets 95  
 TARGET compiler option  
 packaging considerations 1161  
 tasks  
 setting up a stopping point for dbx in optimized code  
 steps for 785  
 using an implicitly loaded DLL in your simple DLL application  
 steps for 294  
 using dbx to step through optimized code  
 steps for 785  
 tasks, using MTF 855  
 TCP socket session 435  
 TCP/IP 446  
 templates  
 TEMPINC  
 examples of source files 458, 459  
 JCL to compile examples 460  
 regenerating the template instantiation file 461  
 TEMPLATEREGISTRY  
 changing and recompiling parts of program 462  
 instantiation with template registry 461  
 using TEMPINC or NOTEMPINC multipurpose header file 458  
 temporary data sets (MVS)  
 using & names 84  
 temporary files 201  
 TERM token preinitialization 261  
 terminals  
 closing 198  
 flushing 197  
 Graphical Data Display Manager (GDDM) 929  
 I/O  
 description 30  
 overview 191

terminals (continued)  
 I/O (continued)  
 reading from files 193  
 writing to files 196  
 opening I/O files 191  
 positioning within 198  
 responses to fldata() 199  
 termination  
 enclave  
 as indicated in CEEAUE\_ABND field of CEEAUE\_FLAGS 845  
 as indicated in CEEAUE\_ABTERM field of CEEAUE\_FLAGS 844  
 CEEBXITA's behavior during 841  
 CEEBXITA's function codes for 843  
 process 841, 843  
 text files  
 ASA RECFM fixed-format behavior 15  
 ASA RECFM undefined-format behavior 20  
 ASA RECFM variable-format behavior 18  
 non-ASA RECFM fixed-format behavior 13  
 non-ASA RECFM undefined-format behavior 19  
 non-ASA RECFM variable-format behavior 18  
 RECFM byte stream behavior 21  
 using fseek() and ftell() 118  
 text I/O 7  
 THREADED compiler option 728  
 threads  
 cancel 362  
 cleanup 364  
 condition variable 355  
 create 353  
 functions 353  
 low-level z/OS UNIX System Services I/O 141  
 management 353  
 mutex 355  
 read-write lock 355  
 recoverable resources 368  
 signals 360  
 thread-specific data 358  
 using in z/OS UNIX System Services applications 353  
 using with MVS files 365  
 throw 403  
 time zone  
 customizing 1013  
 specifying 964  
 tolower() macro 717  
 toupper() macro 717  
 traceback 404  
 transaction execution  
 built-in instructions, hardware 547  
 translation tables 1023  
 transport protocols 426  
 TRAP runtime option  
 CEEBXITA assembler user exit and 841  
 how CEEAUE\_ABND is affected by 845

- TRAP runtime option *(continued)*
  - IMS considerations 936
- troubleshooting
  - stepping through optimized code using dbx 785
- try 403
- TSO (Time Sharing Option)
  - default high-level qualifier 85, 203
  - opening files 85, 203
  - redirecting standard streams 74
  - setting the user prefix 85, 203
- TUNE compiler option 725
- type= parameter
  - memory file I/O 204
  - terminal I/O 192
  - VSAM data sets 159
  - z/OS OS I/O 100
- types, sockets 429
- TZ environment variable 1013
- tzset() library function
  - not thread-safe 367

**U**

- UDP socket session 436
- ulimit command
  - MEMLIMIT system parameter 332
- unary operators, decimal data type
  - digitsof 384
  - precisionof 384
  - sizeof 384
- unbuffered I/O
  - setvbuf() function 102
- undefined format records 19
- ungetc() library function
  - \_EDC\_COMPAT environment variable 488
  - memory file I/O, effect on fflush() 211
  - OS I/O, effect on fflush() 114
  - OS I/O, effect on fgetpos() and ftell() 116
  - SEEK\_CUR 117
- ungetwc() library function
  - effect on fflush(), wide character I/O 59
  - effect on fgetpos(), ftell() and fseek() 60
  - seek\_cur 60
- universal reference time 1013
- unlink() library function
  - using with named pipes 138
  - with z/OS UNIX System Services file system files 135
- unnamed pipes
  - creating 128
  - example 137
  - using 136
- UNROLL compiler option 728
- unroll pragma 709
- unsuffixd numbers
  - ILP32 to LP64 migrations 346
- updating VSAM records 164
- user exit
  - for initialization 840
  - for termination 839, 841
  - runtime options 845

- user exit *(continued)*
  - under CICS 843, 845
- user interface
  - ISPF 1165
  - TSO/E 1165
- user words 835
- user-server stub routines 822

## V

- V-format records 16
- va\_arg macro
  - and decimal data types 390
- value numbering 723
- variable arguments
  - and decimal data types 390
- variable pragma 709
- variable-format records 16
- variables
  - decimal 378
  - environment 467
  - exported 282
  - external 702
  - global 701
  - local 701
  - locale 473
  - register 702
  - static 701
- variant characters 1083
  - default coding 1083
  - detail 1047
  - displaying on workstation or 3270 1083
  - keyboard mapping 1083
  - mapping 1083
  - mappings 1048
  - use of 1047
- VB-format records 16
- VBS-format records 16
- vector built-in functions
  - all predicates 660
  - any predicates 668
  - arithmetic 584
  - compare 599
  - compare ranges 606
  - copy until zero 633
  - find any element 617
  - gather and scatter 625
  - generate mask 631
  - header file 577
  - load and store 634
  - logical 637
  - merge 640
  - operators 674
  - pack and unpack 641
  - replicate 645
  - rotate and shift 648
  - rounding and conversion 656
  - summary 577
  - test 659
  - vec\_abs 584
  - vec\_add\_u128 585
  - vec\_addc 585
  - vec\_addc\_u128 585
  - vec\_adde\_u128 586
  - vec\_addec\_u128 586
  - vec\_all\_eq 660

- vector built-in functions *(continued)*
  - vec\_all\_ge 661
  - vec\_all\_gt 662
  - vec\_all\_le 663
  - vec\_all\_lt 664
  - vec\_all\_nan 665
  - vec\_all\_ne 665
  - vec\_all\_nge 666
  - vec\_all\_ngt 667
  - vec\_all\_nle 667
  - vec\_all\_nlt 667
  - vec\_all\_numeric 667
  - vec\_andc 586
  - vec\_any\_eq 668
  - vec\_any\_ge 668
  - vec\_any\_gt 669
  - vec\_any\_le 670
  - vec\_any\_lt 671
  - vec\_any\_nan 672
  - vec\_any\_ne 672
  - vec\_any\_nge 673
  - vec\_any\_ngt 674
  - vec\_any\_nle 674
  - vec\_any\_nlt 674
  - vec\_any\_numeric 674
  - vec\_avg 587
  - vec\_ceil 656
  - vec\_checksum 588
  - vec\_cmpeq 599
  - vec\_cmpeq\_idx 599
  - vec\_cmpeq\_idx\_cc 600
  - vec\_cmpeq\_or\_0\_idx 600
  - vec\_cmpeq\_or\_0\_idx\_cc 601
  - vec\_cmpge 601
  - vec\_cmpgt 602
  - vec\_cmple 602
  - vec\_cmplt 603
  - vec\_cmpne\_idx 603
  - vec\_cmpne\_idx\_cc 604
  - vec\_cmpne\_or\_0\_idx 604
  - vec\_cmpne\_or\_0\_idx\_cc 605
  - vec\_cmpnrg 606
  - vec\_cmpnrg\_cc 607
  - vec\_cmpnrg\_idx 608
  - vec\_cmpnrg\_idx\_cc 609
  - vec\_cmpnrg\_or\_0\_idx 609
  - vec\_cmpnrg\_or\_0\_idx\_cc 610
  - vec\_cmprg 611
  - vec\_cmprg\_cc 613
  - vec\_cmprg\_idx 613
  - vec\_cmprg\_idx\_cc 614
  - vec\_cmprg\_or\_0\_idx 615
  - vec\_cmprg\_or\_0\_idx\_cc 616
  - vec\_cntlz 637
  - vec\_cnttz 638
  - vec\_cp\_until\_zero 633
  - vec\_cp\_until\_zero\_cc 633
  - vec\_ctd 657
  - vec\_ctsl 657
  - vec\_ctul 657
  - vec\_extend\_s64 657
  - vec\_extract 625
  - vec\_find\_any\_eq 617
  - vec\_find\_any\_eq\_cc 617
  - vec\_find\_any\_eq\_idx 618
  - vec\_find\_any\_eq\_idx\_cc 619
  - vec\_find\_any\_eq\_or\_0\_idx 619

- vector built-in functions (*continued*)
  - vec\_find\_any\_eq\_or\_0\_idx\_cc 620
  - vec\_find\_any\_ne 621
  - vec\_find\_any\_ne\_cc 621
  - vec\_find\_any\_ne\_idx 622
  - vec\_find\_any\_ne\_idx\_cc 623
  - vec\_find\_any\_ne\_or\_0\_idx 623
  - vec\_find\_any\_ne\_or\_0\_idx\_cc 624
  - vec\_floor 658
  - vec\_fp\_test\_data\_class 659
  - vec\_gather\_element 625
  - vec\_genmask 631
  - vec\_genmasks\_16 632
  - vec\_genmasks\_32 632
  - vec\_genmasks\_64 632
  - vec\_genmasks\_8 631
  - vec\_gfmsum 588
  - vec\_gfmsum\_128 588
  - vec\_gfmsum\_accum 588
  - vec\_gfmsum\_accum\_128 589
  - vec\_insert 626
  - vec\_insert\_and\_zero 627
  - vec\_ld2f 634
  - vec\_load\_bndry 634
  - vec\_load\_len 635
  - vec\_load\_pair 635
  - vec\_madd 589
  - vec\_max 589
  - vec\_meadd 590
  - vec\_mergelh 640
  - vec\_mergel 641
  - vec\_mhadd 591
  - vec\_min 591
  - vec\_mladd 592
  - vec\_moadd 592
  - vec\_msub 593
  - vec\_mule 593
  - vec\_mulh 594
  - vec\_mulo 594
  - vec\_nabs 595
  - vec\_nor 638
  - vec\_pack 642
  - vec\_packs 642
  - vec\_packs\_cc 643
  - vec\_packsu 643
  - vec\_packsu\_cc 643
  - vec\_perm 627
  - vec\_perml 628
  - vec\_popcnt 639
  - vec\_promote 629
  - vec\_rl 648
  - vec\_rl\_mask 648
  - vec\_rli 649
  - vec\_round 658
  - vec\_roundc 658
  - vec\_roundm 658
  - vec\_roundp 659
  - vec\_roundz 659
  - vec\_scatter\_element 629
  - vec\_sel 630
  - vec\_slb 649
  - vec\_sld 650
  - vec\_sldw 651
  - vec\_sll 651
  - vec\_splat 645
  - vec\_splat\_s16 646
  - vec\_splat\_s32 646

- vector built-in functions (*continued*)
  - vec\_splat\_s64 646
  - vec\_splat\_s8 646
  - vec\_splat\_u16 647
  - vec\_splat\_u32 647
  - vec\_splat\_u64 647
  - vec\_splat\_u8 646
  - vec\_splats 647
  - vec\_sqrt 595
  - vec\_srab 652
  - vec\_sral 653
  - vec\_srb 654
  - vec\_srl 655
  - vec\_st2f 635
  - vec\_store\_len 635
  - vec\_sub\_u128 596
  - vec\_subc 596
  - vec\_subc\_u128 596
  - vec\_sube\_u128 596
  - vec\_subec\_u128 597
  - vec\_sum\_u128 597
  - vec\_sum2 597
  - vec\_sum4 598
  - vec\_test\_mask 660
  - vec\_trunc 659
  - vec\_unpackh 644
  - vec\_unpackl 644
  - vec\_xld2 636
  - vec\_xlw4 636
  - vec\_xstd2 637
  - vec\_xstw4 637
- vector programming support 553
  - built-in functions 577
  - language extensions 555
    - \_\_alignof\_\_ operator 560
    - addition operator + 563
    - address operator & 560
    - assignment operator = 562
    - binary expressions 561
    - bitwise AND operator & 572
    - bitwise exclusive OR operator ^ 573
    - bitwise inclusive OR operator | 574
    - bitwise left shift operator << 565
    - bitwise right shift operator >> 566
    - cast expressions 576
    - compound literal expressions 576
    - division operator / 563
    - equality operator == 570
    - inequality operator != 571
    - initialization of vectors 558
    - multiplication operator \* 562
    - other extensions 576
    - pointers 559
    - relational greater than operator > 567
    - relational greater than or equal to operator >= 569
    - relational less than operator < 566
    - relational less than or equal to operator <= 568
    - remainder operator % 563
    - sizeof operator 560
    - subscripting operator [] 575

- vector programming support (*continued*)
  - language extensions (*continued*)
    - subtraction operator - 564
    - typedef definitions 559
    - typeof operator 560
    - unary expressions 559
    - unary operators ++ -- + - ~ 559
    - vec\_step operator 560
    - vector literals 555
  - macro 553
  - options 553
  - vector data types 554
- vertical tab escape sequence \v 109
- vfwprintf\_unlocked() library function 56
- vfwprintf() library function 56
- vfwscanf\_unlocked() library function 55
- vfwscanf() library function 55
- virtual
  - optimizing 695
- virtual lookasides
  - optimizing 779
- VS-format records 16
- VSAM (Virtual Storage Access Method)
  - \_\_amrc structure 177
  - closing a data set 176
  - example programs 177
    - KSDS 177
    - RRDS 186
  - example showing how to access \_\_amrc structure 154
- I/O operations
  - deleting a record 165
  - loading a data set 163
  - locating a record 165
  - opening a file 30
  - overview 151
  - reading a record 162
  - repositioning 165
  - specifying access mode 158
  - summary of binary I/O operations 176
  - summary of operations 155
  - summary of record I/O operations 168
  - summary of text I/O operations 175
  - updating a record 164
  - using fopen() 156
  - using freopen() 156
  - writing a record 163
- I/O stream library 151
- keys 154
- KSDS example 177
- linear data sets 151
- naming MVS data sets 157
- organization of data sets 151
- Record Level Sharing 169
- Relative Byte Addresses (RBA) 154
- Relative Record Numbers (RRN) 155
- return codes 177
- RLS 169
- RSDS example 187
- Transactional VSAM 169
- TVS 169
- types and advantages of data sets 153
- vwprintf\_unlocked() library function 56

vwprintf() library function 56  
vwscanf\_unlocked() library function 55  
vwscanf() library function 55

## W

WARN64 compiler option  
  identifying portability problems 330  
wcsid() library function 952  
wide characters  
  effect of MB\_CUR\_MAX 53  
  input and output functions 53  
  reading streams and files 54  
  ungetwc() considerations 59  
  writing streams and files 56  
windowing 929  
wprintf\_unlocked() library function 56  
wprintf() library function 56  
writable static  
  assembler code 373  
  in reentrant programs 369  
write() library function  
  with pipes 137  
  z/OS UNIX System Services file  
  system I/O 134  
writing  
  binary streams, wide character  
  I/O 58  
  in coded character set IBM-1047 1062  
  multibyte characters 56  
  text streams, wide character I/O 56  
  to memory files 210  
  to OS I/O files 107  
  to terminal files 196  
  to the CELQPIPI MSGRTN file 219  
  to the z/OS Language Environment  
  message file 218  
  to z/OS UNIX System Services file  
  system files 134  
  VSAM data sets 163  
wscanf\_unlocked() library function 55  
wscanf() library function 55

## X

X Windows, z/OS TCP/IP 446  
X/Open Socket 425  
X/Open Transport Interface (XTI)  
  concepts 450  
  transport endpoints 451  
  transport providers 451  
XFER, transfer control 905  
xhotc library function 831  
xhotl library function 832  
xhott library function 832  
xhotu library function 833  
XITPTR, CXIT control block 842  
XPLINK  
  and DB2 services, stored  
  procedures 922  
  assembler macros 247  
  register conventions 248  
  when to use 731  
xregs library function 833  
xsacc library function 834  
xusr() library function 835

xusr2() library function 835

## Z

z/OS Basic Skills information  
  center xxxiii  
z/OS Language Environment  
  message file I/O, description 32  
  message file output 217  
z/OS TCP/IP  
  child process creation restrictions 447  
  configuration file access 447  
  header file restrictions 446  
  interprocess communication 446  
  socket API restrictions 446  
z/OS UNIX file system  
  character special 128  
  closing files 135  
  creating files 127  
  deleting 135  
  directory 128  
  example 141, 145  
  FIFO 128  
  file types 127  
  flushing records 134  
  I/O functions, example program 141  
  I/O stream library 127  
  I/O, description 30  
  input and output 127  
  link 128  
  naming files 128  
  reading streams and files 133  
  record I/O rules 132  
  regular 127  
  setting positions within files 134  
  writing to streams and files 134  
z/OS UNIX System Services  
  application programming  
  environment 1155  
  I/O, low-level 141  
  ulimit command 332  
z/OS XL C/C++ integrated CICS  
  translator 894  
zero-byte records,  
  \_EDC\_ZERO\_RECLEN 18, 502  
zFS file systems 721







Product Number: 5650-ZOS

Printed in USA

SC14-7315-08

